

# SANYO

## VCC-ZM400P

### INSTRUCTION MANUAL BEDIENUNGSANLEITUNG MANUEL D'INSTRUCTIONS 使用说明书

**COLOUR CCD ZOOM camera**  
**CCD-Farb-Zoomkamera**  
**Caméra CCD COULEURS avec ZOOM**  
彩色CCD变焦摄像机

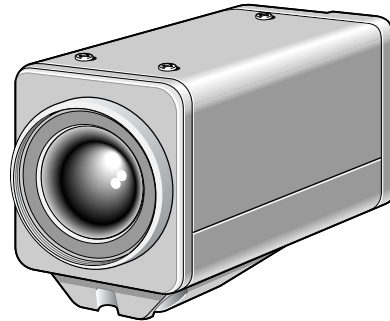

#### **About this manual**

Before installing and using the camera, please read this manual carefully. Be sure to keep it handy for later reference.

#### **Über diese Bedienungsanleitung**

Lesen Sie bitte vor der Montage und dem Inbetriebnehmen der Kamera zuerst diese Bedienungsanleitung sorgfältig durch und bewahren Sie sie zum späteren Nachschlagen auf.

#### **A propos de ce manuel**

Avant d'installer et d'utiliser la caméra, veuillez lire ce manuel attentivement. Gardez-le à portée de main pour toute référence ultérieure.

#### **关于本说明书**

在安装和使用摄像机之前，请仔细阅读本使用说明书，并务必保存好本使用说明书，以备今后查阅。

# CONTENTS

MAIN FEATURES .....	2
ACCESSORIES .....	2
PRECAUTIONS .....	3
PARTS NAMES AND FUNCTIONS .....	4
CONNECTIONS .....	6
■ Basic connection for monitoring or recording .....	6
■ Connection of peripheral equipment and controller terminal .....	7
DISPLAYING/CLOSING THE MENU SCREEN .....	8
MENU ITEM FLOW AND MENU OPERATION .....	9
LANGUAGE SETTING .....	10
CAMERA ID SETTING .....	11
■ Camera ID setting .....	11
SYNC SETTING (SYNC) .....	12
■ Power source synchronization (L-L) setting .....	12
PRIVACY MASK SETTING (PRIVACY MASK) .....	13
■ Mask setting .....	13
■ PASSWORD setting .....	15
■ PASSWORD LOCK cancellation .....	16
■ PASSWORD changes .....	16
LENS SETTING ITEM FLOW .....	17
LENS SETTING (LENS) .....	18
<b>A</b> FOCUS setting .....	18
<b>B</b> ZOOM setting .....	21
<b>C</b> DAY/NIGHT setting .....	23
<b>D</b> VIEW ANGLE setting .....	31
MIRROR SETTING .....	32
VIEW SETTING ITEM FLOW .....	33
VIEW SETTING .....	35

<b>A</b> IRIS setting .....	35
■ Autoiris setting (AUTO) .....	35
■ SENSE UP setting .....	40
■ LEVEL setting .....	40
■ Manual iris setting .....	41
<b>B</b> WHITE BALANCE adjustment .....	42
■ MWB setting .....	43
■ ATW setting .....	43
■ AWC setting .....	45
<b>C</b> Electronic SHUTTER setting .....	46
■ Fast shutter speed (SHORT) mode setting .....	46
■ Slow shutter speed (LONG) mode setting .....	47
<b>D</b> MOTION detector setting .....	48
■ MOTION MASKING setting .....	50
■ SENSITIVITY setting .....	51
■ ZOOM setting .....	52
■ INTERVAL setting .....	52
■ ALARM SIGN setting .....	53
<b>E</b> Profile compensation setting (APERTURE) .....	54
<b>F</b> GAMMA correction setting .....	55
OPTION SETTING .....	56
■ CONTROL setting .....	56
■ ADDRESS setting .....	57
■ ALARM setting .....	57
<b>A</b> Alarm input setting (ALARM IN) .....	57
<b>B</b> Color/black & white selection setting (DAY/NIGHT) .....	59
<b>C</b> Alarm output setting (ALARM OUT) .....	60
<b>D</b> Operation of alarm signal output to the System Controller setting (LINE OUT) .....	61
MENU FLOW .....	62
SPECIFICATIONS .....	64

## MAIN FEATURES

---

- Built in Interline transfer method 1/4" CCD, approx. 470,000 picture elements.
- High sensitivity, minimum required illumination is 1.2 lux. (F1.6, gain max)
- More than 520 TV lines of horizontal resolution.
- Equipped with intelligent Backlight compensation.
- Special Gamma mode (contrast up)
- Built in high speed electronic shutter and slow shutter.
- 32X Electronic sensitivity
- Built in Digital Motion Detection
- Built in Privacy masking function
- 12VDC/24V AC dual operation(electrically isolate) .
- Internal sync. / Line Lock.
- 22x optical zoom and 16x electronic zoom.
- Coaxial control or RS485, operation via SSP.
- The Day/Night function is a function that can adapt to a wide range of changing luminance levels by automatically switching to color during daytime, or to black and white at times of low luminance such as nighttime.

## ACCESSORIES

---

Clamping core ..... 1 pc.

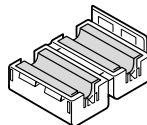

# PRECAUTIONS

## ■ In case of problem

Do not use the camera if smoke or a strange odour comes from the unit, or if it seems not to function correctly. Disconnect the power cord immediately, and consult your dealer (or a Sanyo Authorized Service Centre).

## ■ Do not open or modify

Do not open the cabinet, as it may be dangerous and cause damage to the unit. For internal settings and repairs, consult your dealer (or a Sanyo Authorized Service Centre).

## ■ Do not put objects inside the unit

Make sure that no metal objects or flammable substance get inside the camera. If used with a foreign object inside, it could cause a fire, short-circuits or damages.

If water or a liquid gets inside the camera, disconnect the power cord immediately, and consult your dealer (or a Sanyo Authorized Service Centre). Be careful to protect the camera from rain, sea water, etc.

## ■ Be careful when handling the unit

To prevent damages, do not drop the camera or subject it to strong shock or vibration.

## ■ Install away from electric or magnetic fields

If installed close to a TV, radio transmitter, magnet, electric motor, transformer, audio speakers the magnetic field they generate will distort the image.

## ■ Protect from humidity and dust

To prevent damages to the camera, do not install it where there is greasy smoke or steam, where the dampness may get too high, or where there is a lot of dust.

## ■ Protect from high temperatures

Do not install close to stoves, or other heat generating devices, such as spotlights, etc., or where it could be subject to direct sunlight, as that could cause deformation, discoloration or other damages.

Be careful when installing close to the ceiling, in a kitchen or boiler room, as the temperature may raise to high levels.

Install where the temperature range will stay between  $-10^{\circ}\text{C}$  and  $50^{\circ}\text{C}$ . (no condensation)

## ■ Cleaning

- Dirt can be removed from the cabinet by wiping it with a soft cloth. To remove stains, wipe with a soft cloth moistened with a soft detergent solution and wrung dry, then wipe dry with a dry soft cloth.
- Do not use benzine, thinner or other chemical product on the cabinet, as that may cause deformation and paint peeling. Before using a chemical cloth, make sure to read all accompanying instructions. Make sure that no plastic or rubber material comes in contact with the cabinet for a long period of time, as that may cause damage or paint peeling.

# PARTS NAMES AND FUNCTIONS

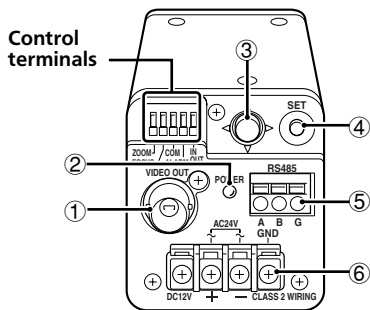

## ① Video output connector (VIDEO OUT: BNC type)

Connect this connector to a device such as a time lapse VCR or monitor with a **VIDEO IN** connector.

## ② Power indicator (POWER)

Comes on when the power to the camera is on.

**Note:** After connecting the power supply the POWER indicator will blink for 5 seconds. During this time no adjustments using the menus or any other operation are possible.

## ③ Cursor button (See p8)

- ▲: Press this button to move the cursor up.
- ▶: Press this button to move the cursor to the right, or to turn the settings ON/OFF etc.
- ◀: Press this button to move the cursor to the left, or to turn the settings ON/OFF etc.
- ▼: Press this button to move the cursor down.

## ④ SET button (SET) (See p8)

Connect the camera to the monitor, then press the **SET** button for about 3 seconds to display the on-screen menu.

## ⑤ RS-485 control push-lock terminals (RS485, A, B, G)

Use a cable thicker than AWG22.

**A:** Twisted-pair cable terminal    **G:** Ground terminal

**B:** Twisted-pair cable terminal

## ⑥ 24 V AC or 12 V DC input terminals (AC 24 V, DC 12 V, GND)

## Lens cap

The cap is installed to protect the lens section. Remove the cap when using the camera.

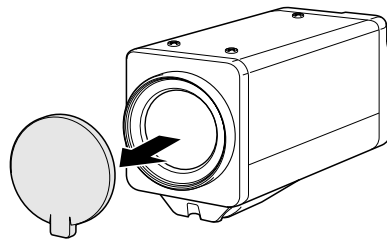

# PARTS NAMES AND FUNCTIONS

## Camera installation bracket

The bracket can be fixed at the top or bottom of the camera.

**CAUTION:** When installing the camera bracket, select a location that can support the total weight of the camera and accessories.

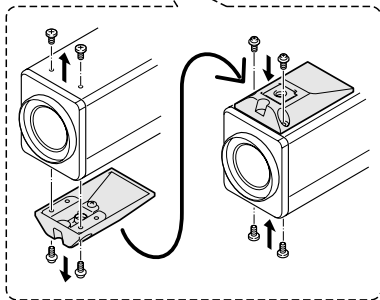
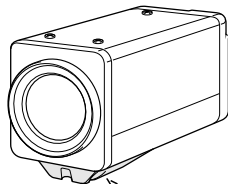

## Control terminals

### ① Zoom terminal (ZOOM)

Sets the zoom to wide angle or telescoping.

### ② Focus terminal (FOCUS)

Sets the focus to infinite or close range.

### ③ Grounding terminal (COM)

### ④ Alarm output terminal (ALARM OUT)

A detection alarm based on the motion sensor is sent to connected equipment such as a buzzer or lamp or a time lapse VCR device.

### ⑤ Alarm input and color/black & white selection terminal (ALARM IN)

- When using this terminal for alarm input, connect an external alarm switch for detecting intruders.
- This terminal can also be used for selecting color or black & white input. It can be used to force selection of color or black & white mode by external operation.

**Note:** The ALARM IN terminal can only receive one type of input at a time. When using this terminal, use the ALARM settings to set the type of input. (See p57)

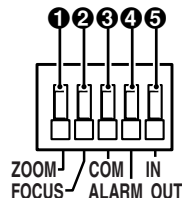

# CONNECTIONS

## ■ Basic connection for monitoring or recording

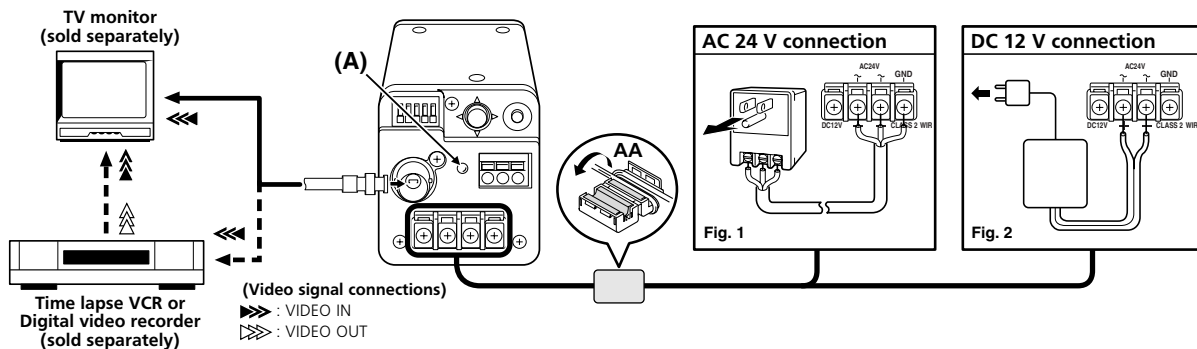

The peripheral devices (VCR, monitor, lens, etc.) and cables are sold separately.

### 1 Make the video signal connection between the camera and the monitor or time lapse VCR.

When using this unit, the supplied clamping core **AA** must be installed on the power cord, in order to prevent electromagnetic interference to the other devices connected.

### 2 Power supply choices

- When using a commercially available 24 V AC adaptor, make sure to use a cable with an earth line (22AWG or more) to connect to the grounding terminal. (Fig.1.)
- When using a DC 12 V power supply, make the connections as indicated in Fig. 2.

### CAUTION:

To prevent camera and/or power supply failure, pay close attention to polarity when making the connections.

### 3 Insert the plug of this power supply into a wall outlet.

The **POWER** indicator (A) will light. Adjust the picture on the monitor using the Brightness and Contrast controls.

# CONNECTIONS

## ■ Coaxial cable type and maximum length

- Cable type RG-59U (3C-2V), 250 m maximum.
- Cable type RG-6U (5C-2V), 500 m maximum.
- Cable type RG-11U (7C-2V), 600 m maximum.

## CAUTION:

- The RG-59U type cable should not be run through electrical conduits or through the air.
- Using CCTV/Video-grade coaxial cable.

## ■ Connection of peripheral equipment and controller terminal

- Focus adjustment  
DC+6V/12V: Infinite  
DC-6V/12V: Close range
- Zoom adjustment  
DC+6V/12V: Wide angle  
DC-6V/12V: Telescoping

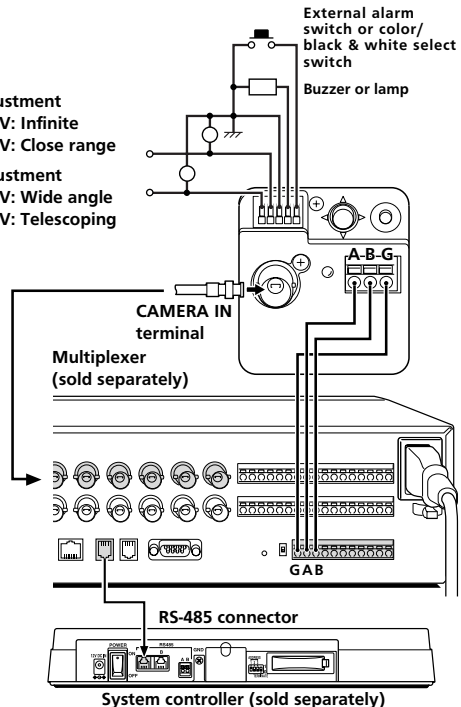



# DISPLAYING/CLOSING THE MENU SCREEN

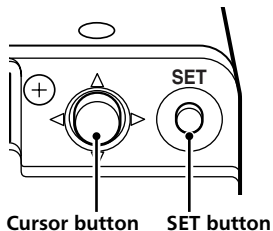

MAIN MENU screen

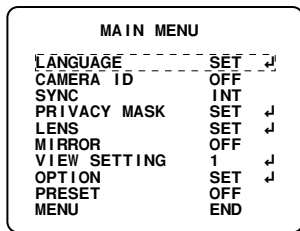

Sub-menu screen

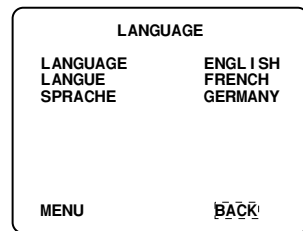

## 1 Press the SET button for about 3 seconds.

The **MAIN MENU** screen will appear.

## 2 Using the cursor button

- 1 Use the cursor button (▼) to move the cursor down. When the cursor reaches the bottom of the screen, it goes back up to the top of the screen.
- 2 Use the cursor button (▲) to move the cursor up. When the cursor reaches the top of the screen, it goes back down to the bottom of the screen.
- 3 Use the cursor button (▶) to move the cursor to the right. This button is also used to change ON/OFF settings etc.
- 4 Use the cursor button (◀) to move the cursor to the left. This button is also used to change ON/OFF settings etc.

## 3 Switching to sub-menu screens

Use the cursor button (▲▼◀▶) until an item with a "↕" next to it is flashing, then press the **SET** button.

## 4 Closing a settings screen

- To return to the previous screen, use the cursor button (▼) to select BACK for MENU, then press the **SET** button.
- To return to the normal screen, use the cursor button (◀ or ▶) to select END for MENU, then press the **SET** button.

### 🔍 Returning to the default setting

Use cursor button (▼, then ◀ or ▶) to change the **PRESET** setting to **ON**, then press the **SET** button.

# MENU ITEM FLOW AND MENU OPERATION

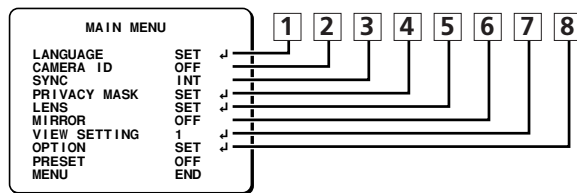

## 1 LANGUAGE setting (See p10)

Choose from among English, French and German.

## 2 CAMERA ID setting (See p11)

## 3 SYNC setting (See p12)

Sets camera to internal synchronization (INT) or power source synchronization (L-L).

Power source synchronization, the vertical synchronization phase as adjusted on a sub-menu screen.

## 4 PRIVACY MASK setting (See p13)

This covers an area of the screen with a gray pattern for areas that may infringe on privacy.

Gray patterns can be placed on up to 4 areas.

## 5 LENS setting (See p17)

This lets you make settings such as automatic and manual focus settings, zoom speed and zoom ratio. In addition, it can also be used for automatic switching to color images during daytime, or to black and white images at times of low luminance such as nighttime.

## 6 MIRROR setting (See p32)

The image can be rotated horizontally then vertically or vertically then horizontally.

## 7 VIEW SETTING (See p33)

Different detailed settings can be made for each camera (9 screens). After they are set, these are linked to "VIEW SETTING (0 - 8)" settings for preset positions.

## 8 OPTION setting (See p56)

For setting communications conditions and alarms.

# LANGUAGE SETTING

Select one of the languages shown on the menu screen (English, French, German).

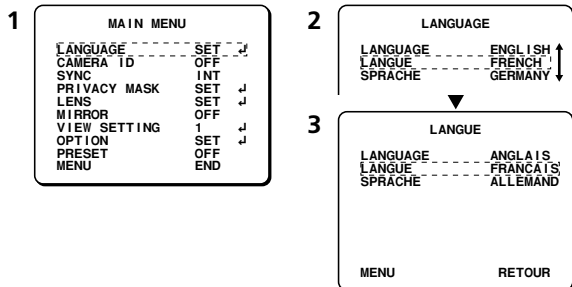

- 1** In the MAIN MENU, use the cursor button (▲ or ▼) to select SET for LANGUAGE, then press the SET button.

The LANGUAGE screen will appear.

- 2** Use the cursor button (▲ or ▼) to move the cursor to language (e.g. FRENCH) then press the SET button.

The interface language becomes French.

- 3** Use the cursor button (▲ or ▼) to select RETOUR for MENU, then press the SET button.

The MENU PRINCIPAL screen will reappear.

Information in the MAIN MENU screen will appear in the selected language.

- 4** Use the cursor button (▼) to select FIN, then press the SET button. The display will return to the normal monitor screen.

# CAMERA ID SETTING

## ■ Camera ID setting

Example: Setting the Camera ID to "CAM 1"

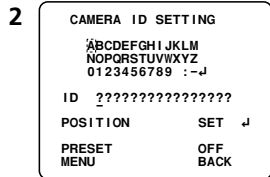
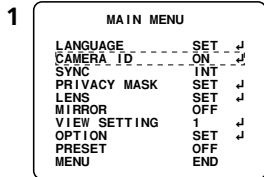

- 1 Use the cursor button (▲ or ▼) to move the cursor to CAMERA ID, and then use the cursor button (◀ or ▶) to change the setting to ON. Then press the SET button.

The CAMERA ID SETTING screen will appear.

- 2 Use the cursor button (▲ ▼ ◀ ▶) to move the cursor to the letter "C" in the character selection palette, then press the SET button.

- After at least one character is displayed in the ID field, the carriage return mark (↵) will appear at the lower right corner of the character selection palette. Selecting this mark between the characters of the field will create a new line at that place.

- 3 Use the same steps to select "A", "M" and "1" from the palette, then press the SET button.

The characters "CAM1" appear in the ID field.

ID CAM1????????????

### Camera ID screen

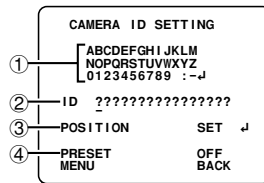

#### ① Character selection palette:

By moving the cursor to letters or numbers in this palette, you can select characters.

Selected characters will appear in the corresponding field under ID.

#### ② ID:

When CAMERA ID is set to "OFF", the 16 characters in the ID field will all change to "?" but will not be displayed on the screen. In addition, when the setting is "ON", "?" characters will appear on the screen when no ID has been entered.

#### ③ POSITION:

After characters are displayed in the ID field, moving the cursor to the POSITION field with the cursor button and pressing the SET button will display the camera ID on the normal screen.

#### ④ PRESET:

When this item is turned to ON, the ID fields are cleared (question marks appear). Use this function when you want to change the ID.

## CAMERA ID SETTING

- 4 Use the cursor button (▲ or ▼) to move the cursor to POSITION, and then press the SET button.**

The camera ID will be displayed on one line.

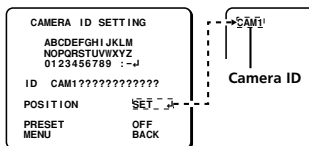

**(Displaying the ID on 2 lines.)**

- 1 Use the cursor button (◀ or ▶) to move the cursor to the location in the ID field where the carriage return is wanted.
  - 2 Use the cursor button (▲ ▼ ◀ ▶) to move the cursor to the carriage return mark (↵) at the lower right corner of the character selection palette, and then press the **SET** button.
- 5 Moving the on-screen title display position**
- Use the cursor button (▲ ▼ ◀ ▶) to move the title display to the preferred position on the screen, then press the SET button.**

The CAMERA ID SETTING screen will reappear.

## SYNC SETTING (SYNC)

Default setting is internal synchronization (INT), so it does not need to be set again. Follow the steps below to change the setting to power source synchronization (L-L).

### ■ Power source synchronization (L-L) setting

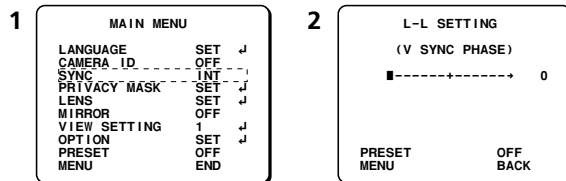

- 1 Use the cursor button (▲ ▼ ◀ ▶) to select L-L for SYNC, then press the SET button.  
The L-L SETTING screen will appear.
  - 2 Use the cursor button (◀ or ▶) to adjust the position of the vertical synchronization indicator shown on the screen.  
The numerical value will change, allowing adjustment of vertical synchronization.
- 🔊 To close the menu screen or return to the previous screen, select BACK or END for MENU and press the SET button.

# PRIVACY MASK SETTING (PRIVACY MASK)

## ■ Mask setting

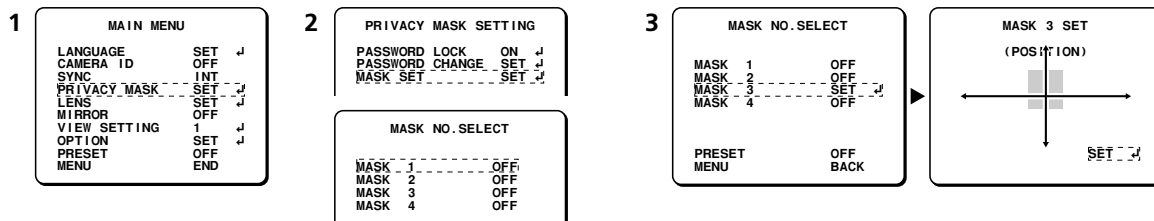

- 1** Use the cursor button (▲ or ▼) to select SET for PRIVACY MASK, then press the SET button.

The PRIVACY MASK SETTING screen will appear.

- 2** Use the cursor button (▲ or ▼) to move the cursor to SET for MASK SET and press the SET button.

The MASK NO. SELECT screen will appear.

**Note:** When PASSWORD LOCK is ON, moving the cursor to MASK SET and press the SET button to bring up a password access screen. The password must be entered in this screen.

- 3** Use the cursor button (▲ or ▼) to move the cursor to a mask number (e.g. MASK 3), and then use the cursor button (▶) to change the setting to SET. Then press the SET button.

The MASK 3 SET (POSITION) screen will appear, and SET↵ will be blinking. The gray mask will appear in the center of the screen.

### Cursor button operation

**OFF:** to ▶ side (ON appears), to ▶ side again (SET appears)

- **SET:** Mask POSITION and SIZE can be set
- **ON:** Masks can be displayed
- **OFF:** Masks can be deleted

# PRIVACY MASK SETTING (PRIVACY MASK)

## (About the POSITION screen)

It is possible to set as many as 4 masks on the same POSITION screen.

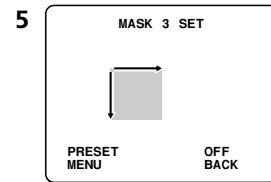
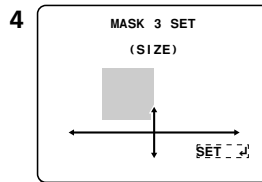
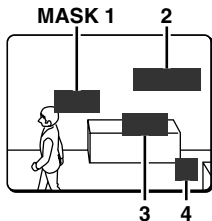

- 4** Use the cursor button (▲▼◀▶) to move the gray mask, then press the SET button.

The SIZE screen will appear, and the mask that was positioned in the POSITION screen will be displayed.

- 5** Use the cursor button (▲▼◀▶) to adjust the size of the gray mask, then press the SET button.

PRESET and MENU will appear at the bottom of the screen. Move the cursor to BACK for MENU and press the SET button. The screen will return to MASK NO. SELECT.

- ⓘ** To close the menu screen or return to the previous screen, select BACK or END for MENU and press the SET button.

# PRIVACY MASK SETTING (PRIVACY MASK)

## ■ PASSWORD setting

You can lock the privacy masks in place as gray patterns after they have been set. The password requirement is initially set to OFF, but to begin using it, you must enter the factory set password "1234".

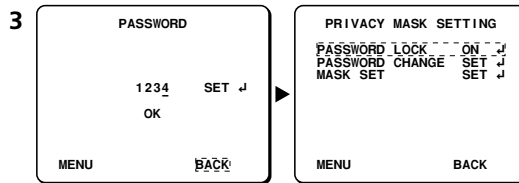
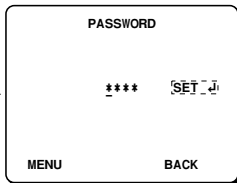
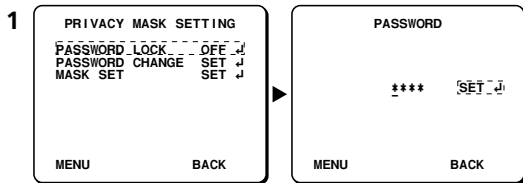

- 1 Use the cursor button (▲ or ▼) to move the cursor to OFF for PASSWORD LOCK in the PRIVACY MASK SETTING screen. Then press the SET button.

The PASSWORD screen will appear.

- 2 Enter the factory set password "1234".

Use the cursor button (▲ or ▼) to select "1", then use the cursor button (▶).

To move the cursor to the next "\*" digit.



- 3 Use the same steps to enter "2", "3" and "4", then press the SET button.

"OK" will appear and BACK for MENU will be blinking. Press the SET button again. The PRIVACY MASK SETTING screen will reappear and "ON" will be blinking for PASSWORD LOCK.

**Note:** If a different password is required, "NG" will appear. Please carefully maintain the password so that it will not be forgotten.



# PRIVACY MASK SETTING (PRIVACY MASK)

## ■ PASSWORD LOCK cancellation

For use when PASSWORD LOCK is ON

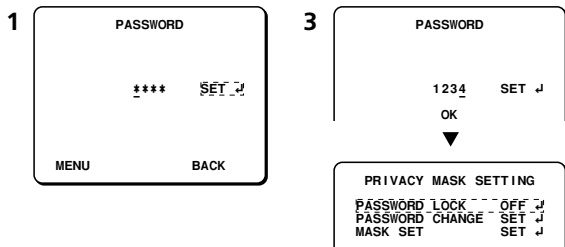

### 1 Press the SET button.

The PASSWORD screen will appear.

### 2 Enter the factory set password "1234".

Use the cursor button (▲ or ▼) to select "1", then use the cursor button (▶).

To move the cursor to the next "\*" digit.

### 3 Use the same steps to enter "2", "3" and "4", then press the SET button.

"OK" will appear and BACK for MENU will be blinking. Press the SET button again. The PRIVACY MASK SETTING screen will reappear and "OFF" will be blinking for PASSWORD LOCK.

## ■ PASSWORD changes

You can change the password with PASSWORD LOCK in either the ON or OFF setting.

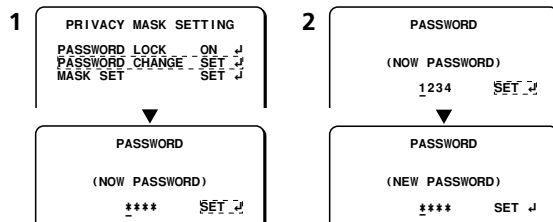

### 1 Use the cursor button (▲ or ▼) to move the cursor to SET for PASSWORD CHANGE and press the SET button.

The PASSWORD (NOW PASSWORD) screen will appear.

### 2 Use the cursor button (◀ or ▶, ▲) to enter the current password (e.g. 1234), then press the SET button.

The PASSWORD (NEW PASSWORD) screen will appear.

### 3 Use the cursor button (◀ or ▶, ▲) to enter a new password (e.g. 4321), then press the SET button.

"OK" will appear and BACK for MENU will be blinking. Press the SET button again.

The PRIVACY MASK SETTING screen will reappear.

# LENS SETTING ITEM FLOW

MAIN MENU		
LANGUAGE	SET	↓
CAMERA ID	OFF	
SYNC	INT	
PRIVACY_MASK	SET	↓
LENS	SET	↓
MIRROR	OFF	
VIEW SETTING	1	↓
OPTION	SET	↓
PRESET	OFF	
MENU	END	



LENS		
FOCUS	MANU	↓
ZOOM	SET	↓
DAY/NIGHT	AUTO	↓
VIEW ANGLE	OFF	
PRESET	OFF	
MENU	BACK	

## **A** FOCUS: (See p18)

These settings let you select automatic focus (AUTO) or manual focus. Change the focus settings in accordance with the monitoring conditions.

## **B** ZOOM: (See p21)

These settings let you adjust the speed and zoom ratio when using electronic zoom.

## **C** DAY/NIGHT: (See p23)

These settings can be used for automatic switching to color images during daytime, or to black and white images at times of low luminance such as nighttime. Three modes (AUTO, COLOR and B/W) can be selected. Change the settings in accordance with the monitoring conditions.

## **D** VIEW ANGLE: (See p31)

These settings are for setting the image angle.

If "OVER" is set, the image angle is set to approximately 1.05.

# LENS SETTING (LENS)

This item allows adjustment of focus (for manual focus or autofocus) and adjustment of zoom when needed.

## **A** FOCUS setting

### Setting the manual focus (MANU)

Sets a limit for near distance focusing and sets focus speed for manual focus.

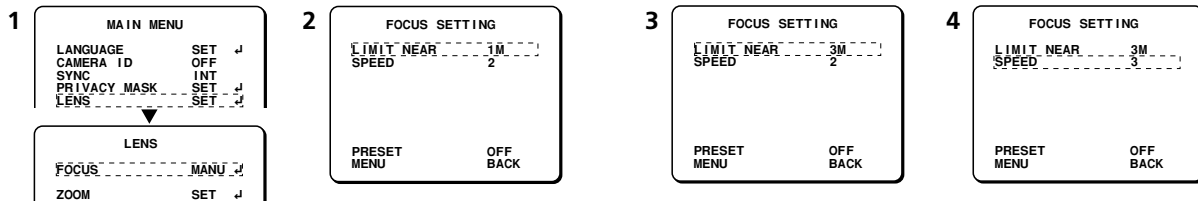

- 1** Use the cursor button (**▲** or **▼**) to select SET for LENS, then press the SET button.

The LENS screen will appear.

- 2** Use the cursor button (**◀** or **▶**) to select MANU, then press the SET button.

The FOCUS SETTING screen will appear.

- 3** LIMIT NEAR focus distance setting

Use the cursor button (**▲** or **▼**) to move the cursor to LIMIT NEAR, then use the cursor button (**◀** or **▶**) to change the distance value. (e.g. 3M)

**Available settings:** 1M (meter), 3M, 10C (centimeters), 30C, 50C

**Note:** Focusing becomes difficult when near distance limit is set to less than "1M".

- 4** SPEED of focus setting

Use the cursor button (**▲** or **▼**) to move the cursor to SPEED, then use the cursor button (**◀** or **▶**) to select the focus adjustment speed value. (e.g. 3)

**Available settings:** 1, 2, 3, 4 (Quickest speed)

-  To close the menu screen or return to the previous screen, select BACK or END for MENU and press the SET button.**

# LENS SETTING (LENS)

## Setting the autofocus (AUTO)

Sets a limit for near distance focusing and sets focusing sensitivity and focus target area.

**Note:** As a normal practice, use manual focus when keeping the camera focused on the same target object for a long period of time (over 24 hours). This can be used with the one-push autofocus function when needed (operated from the system controller). Long periods of surveillance with the autofocus in operation will shorten the work life of the lens.

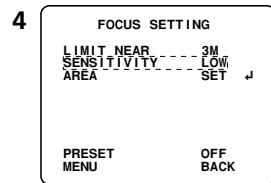
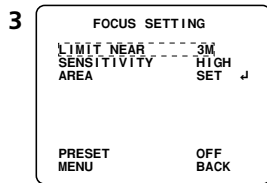
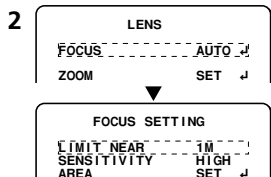
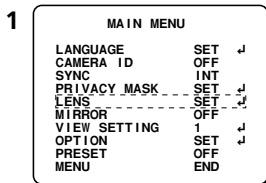

- 1** Use the cursor button (▲ or ▼) to select SET for LENS, then press the SET button.

The LENS screen will appear.

- 2** Use the cursor button (◀ or ▶) to select AUTO, then press the SET button.

The FOCUS SETTING screen will appear.

- 3** LIMIT NEAR focus distance setting

Use the cursor button (▲ or ▼) to move the cursor to LIMIT NEAR, then use the cursor button (◀ or ▶) to change the distance value. (e.g. 3M)

**Available settings:** 1M (meter), 3M, 10C (centimeters), 30C, 50C

- 4** Setting focus SENSITIVITY

Use the cursor button (▲ or ▼) to move the cursor to SENSITIVITY, then use the cursor button (◀ or ▶) to change the setting. (e.g. LOW)

**Available settings:**

- **HIGH:** High sensitivity focusing
- **LOW:** Low sensitivity focusing

**Note:** When focus SENSITIVITY is set to **HIGH**, it may react to even slight movements of the target object. In this case, change the setting to **LOW**.

**Note:** Focusing becomes difficult when near distance limit is set to less than "1M".

## LENS SETTING (LENS)

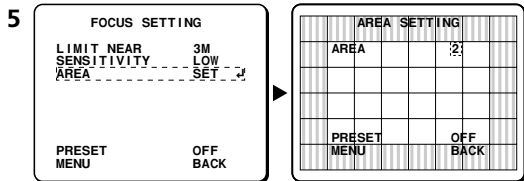

- 5 Use the cursor button (▲ or ▼) to move the cursor to SET for AREA, and press the SET button.

The AREA SETTING screen for AREA 2 (default setting) will appear to allow setting of focus target area.

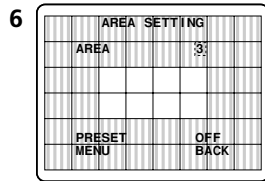

- 6 Use the cursor button (◀ or ▶) to select the focus target area. (e.g. 3)

The focus target area will become narrow.

**Available settings:** 1/full screen, 2/center of screen, 3/smaller center

- ☞ To close the menu screen or return to the previous screen, select BACK or END for MENU and press the SET button.

# LENS SETTING (LENS)

## B ZOOM setting

Sets zooming speed and magnification power of the electronic zoom. This item also has a setting for improvement of vertical resolution sensitivity of still pictures.

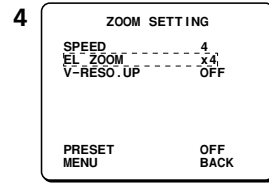
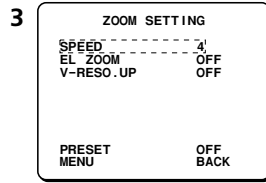
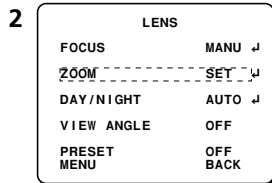
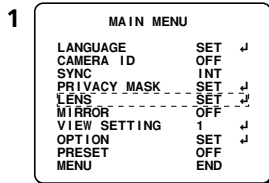

- 1 Use the cursor button (▲ or ▼) to select SET for LENS, then press the SET button.

The LENS screen will appear.

- 2 Use the cursor button (▲ or ▼) to select SET for ZOOM, then press the SET button.

The ZOOM SETTING screen will appear.

- 3 Zoom speed setting

Use the cursor button (◀ or ▶) to select the zooming speed. (e.g. 4)

Available settings: 1, 2, 3, 4 (Quickest speed)

- 4 EL ZOOM (Electronic zoom) magnification setting

Use the cursor button (▲ or ▼) to move the cursor to EL ZOOM, then use the cursor button (◀ or ▶) to select the electronic zoom magnification power. (e.g. x4)

Available settings: OFF, x2, x4, x8, x16 (16 power)

## LENS SETTING (LENS)

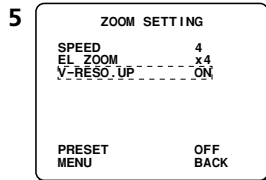

### 5 V-RESO.UP (Vertical resolution sensitivity) setting

Use the cursor button (▲ or ▼) to move the cursor to V-RESO.UP, then use the cursor button (◀ or ▶) to select the vertical resolution sensitivity. (e.g. ON)

**Note:** When V-RESO.UP is set to “ON”, vertical resolution sensitivity for still pictures in the electronic zoom field will be improved but afterimages of moving objects will be more conspicuous.

☞ **To close the menu screen or return to the previous screen, select BACK or END for MENU and press the SET button.**

#### **Note:**

V-RESO. UP will be automatically set to OFF when any of the following settings is made.

- **IRIS SETTING: SENSE UP (x2...)**(See p40)
- **VIEW SETTING: SHUTTER (LONG)**(See p47)
- **D/N SETTING: DNR (ON)**(See p25)

# LENS SETTING (LENS)

## C DAY/NIGHT setting

The DAY/NIGHT mode can be set to one of three settings (AUTO, COLOR or B/W) to improve the appearance of images. This lets you set the filming mode to color mode during times of normal brightness, or to black & white mode to increase sensitivity when there is less light. When you select a mode, you may then need to make detailed settings for the respective mode used.

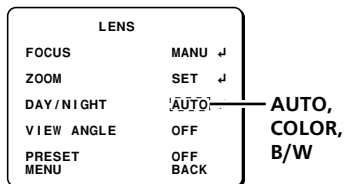

- **AUTO:** Automatic mode; The mode switches automatically between color mode and black & white mode depending on the luminance of the objects being monitored. (See p24)
- **COLOR:** Color mode; Images are filmed in color regardless of the luminance of the objects being monitored. (See p27)
- **B/W:** Black & white mode; Images are filmed in black & white regardless of the luminance of the objects being monitored. (See p28)

**Note:** When “**COLOR**” is selected, the mode is fixed at color and you can only view images that are in color. The same applies to B/W mode. However, you can also use the ALARM IN terminal on the rear panel to force the mode to change from COLOR to B/W or from B/W to COLOR. Refer to the “**Color/black & white selection setting**” for details on the setting method. (See p59)

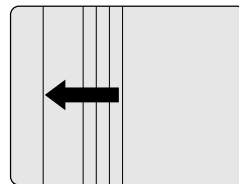

(Fig. 1)

### Note:

- A sound may be heard when the colour image or black and white image is switched. Also, the image will be distorted as shown in **Fig. 1**. This is normal and does not indicate a problem.
- When using infrared lighting, if there is a strong reflection on the subject, the optical filter may switch from black and white to colour mode. Use only enough infrared lighting so that the mode is not switched.



# LENS SETTING (LENS)

## 🔍 AUTO mode setting

### Note:

- If the backlight compensation has been set to "MULTI", the backlight compensation will be canceled when the mode is switched to B/W.
- If "SENSE UP" has been activated, SENSE UP mode will be activated after the mode switches to B/W mode.

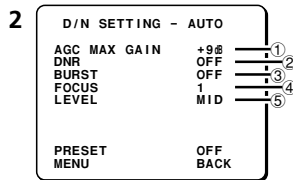
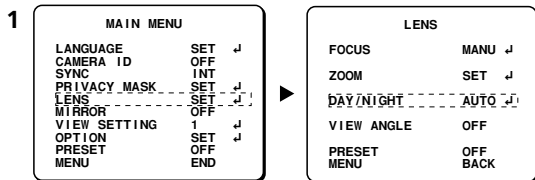

- 1 Use the cursor button (▲ or ▼) to select SET for LENS, then press the SET button.

The LENS screen will appear.

- 2 Use the cursor button (▲ or ▼) to move the cursor to DAY/NIGHT, use the cursor button (◀ or ▶) to select the mode (e.g. AUTO), and then press the SET button.

The D/N SETTING - AUTO screen will appear, and the "+9dB" setting for "AGC MAX GAIN" will be blinking.

- ① Sets the maximum AGC gain.
- ② Sets the digital noise reduction.

- ③ Sets burst suppression. If other peripheral devices (such as a multiplexer) are connected to the system, bursts (distortion of image color) can occur when switching between color and black & white. If this happens, change the BURST setting to "ON".
- ④ Sets the focus when switching to black & white mode.
- ⑤ Sets the switching level for color mode and black & white mode. The three available settings are LOW, MID or HIGH. In addition, the switching level can be set manually (ADJ).

# LENS SETTING (LENS)

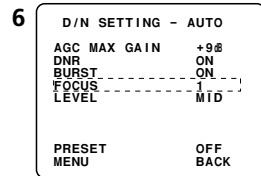
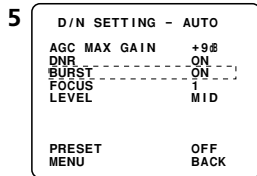
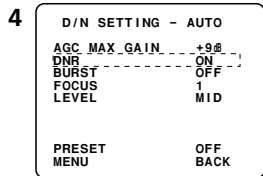
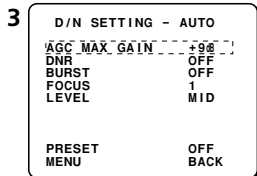

## 3 AGC MAX GAIN setting

Use the cursor button (▲ or ▼) to move the cursor to AGC MAX GAIN, and then use the cursor button (◀ or ▶) to select the gain.

**Available settings:** Select the maximum AGC gain from +9dB, +12dB or +15dB.

## 4 DNR setting

Use the cursor button (▲ or ▼) to move the cursor to DNR, and then use the cursor button (◀ or ▶) to select the digital noise reduction setting (e.g. ON).

**Available settings:**

- **ON:** DNR (digital noise reduction) is applied. This reduces interference at low luminance levels.
- **OFF:** DNR is not applied.

**Note:** Digital noise reduction operates when the gain control increases. In addition, blurring and ghosting of images can occur when moving images are being monitored, and so the resolution is also reduced slightly.

## 5 BURST setting

Use the cursor button (▲ or ▼) to move the cursor to BURST, and then use the cursor button (◀ or ▶) to select the burst setting (e.g. ON).

**Available settings:**

- **ON:** The color burst signal is turned on.
- **OFF:** This should normally be set to "OFF".

## 6 FOCUS setting

Use the cursor button (▲ or ▼) to move the cursor to FOCUS, and then use the cursor button (◀ or ▶) to select the focus setting (e.g. 1).

**Available settings:**

- **1:** Near-infrared wavelength correction is set. (around 900 nm)
- **2:** Visible light spectrum is set.

**Note:** This is set to "1" at the time of shipment from the factory. If the images are out of focus, change it to "2".

## LENS SETTING (LENS)

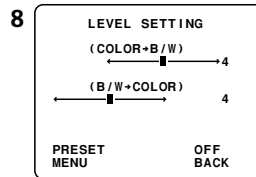
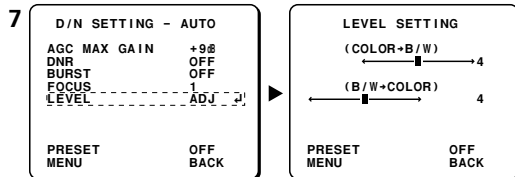

### 7 LEVEL setting

Use the cursor button (**▲** or **▼**) to move the cursor to **LEVEL**, use the cursor button (**◀** or **▶**) to select the level setting (e.g. **ADJ**) and then press the **SET** button.

The LEVEL SETTING screen will appear.

#### Available settings:

- **LOW:** The mode switches when the luminance of the objects being monitored is comparatively dark.
- **MID:** The mode switches when the luminance of the objects being monitored is between the LOW and HIGH levels.
- **HIGH:** The mode switches when the luminance of the objects being monitored is comparatively bright.
- **ADJ:** The switching level for color mode to black & white mode and for black & white mode to color mode respectively can be set manually.

### 8 Use the cursor button (**▲** or **▼**) to move the cursor to **COLOR+B/W**, and then use the cursor button (**◀** or **▶**) to select the value.

Available settings: 1 – 7

#### Note:

- The larger the value, the darker the switching level.
- Changing the setting for one of the switching level settings (from color mode to black & white mode or from black & white mode to color mode) causes the other setting to change also.
- Set the switching level from black & white mode to color mode in the same way.

# LENS SETTING (LENS)

## COLOR mode setting

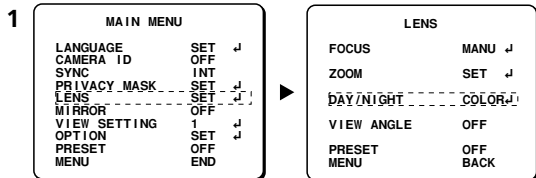

- 1 Use the cursor button (▲ or ▼) to select SET for LENS, then press the SET button.

The LENS screen will appear.

- 2 Use the cursor button (▲ or ▼) to move the cursor to DAY/NIGHT, use the cursor button (◀ or ▶) to select the level setting (e.g. COLOR) and then press the SET button.

The D/N SETTING - COLOR screen will appear, and the “±0dB” setting for “AGC MAX GAIN” will be blinking.

- ① Sets the maximum AGC gain.
- ② Sets the digital noise reduction.

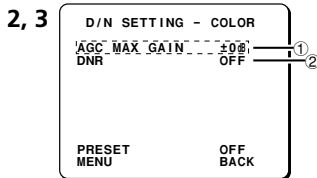

- 3 AGC MAX GAIN setting

Use the cursor button (▲ or ▼) to move the cursor to AGC MAX GAIN, and then use the cursor button (◀ or ▶) to select the gain.

**Available settings:** Select the maximum AGC gain from OFF, -6dB, ±0dB, +6dB or +9dB.

### Setting fixed gain manually

Set AGC MAX GAIN to “OFF” and then press the SET button.

The GAIN SETTING screen will appear. You can use this screen to set the gain value manually to within a range of 0 – 30 dB.

### Note:

- If “OFF” is selected, no maximum gain will be set.
- If “OFF” is selected, the SENSE UP function will be forcibly set to “OFF”. However, the setting display will not change.

# LENS SETTING (LENS)

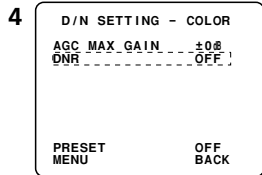

## 4 DNR setting

Use the cursor button (▲ or ▼) to move the cursor to DNR, and then use the cursor button (◀ or ▶) to select the digital noise reduction setting (e.g. ON).

Available settings:

- **ON:** DNR (digital noise reduction) is applied. This reduces interference at low luminance levels.
- **OFF:** DNR is not applied.

**Note:**

- Digital noise reduction operates when the gain control increases. In addition, blurring and ghosting of images can occur when moving images are being monitored, and so the resolution is also reduced slightly.
- If AGC MAX GAIN is set to "OFF", DNR will be forcibly set to "OFF".

To close the menu screen or return to the previous screen, select BACK or END for MENU and press the SET button.

## B/W mode setting

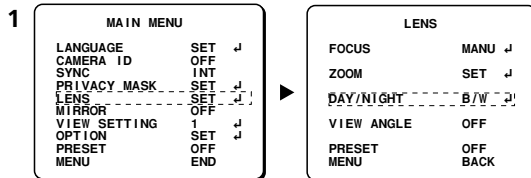

- 1 Use the cursor button (▲ or ▼) to select SET for LENS, then press the SET button.

The LENS screen will appear.

## LENS SETTING (LENS)

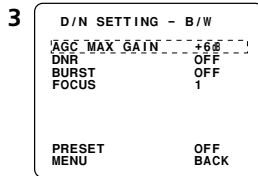
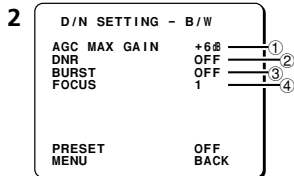

- 2 Use the cursor button (▲ or ▼) to move the cursor to **DAY/NIGHT**, use the cursor button (◀ or ▶) to select the level setting (e.g. B/W) and then press the **SET** button.

The D/N SETTING - B/W screen will appear, and the “+6dB” setting for “**AGC MAX GAIN**” will be blinking.

- ① Sets the maximum AGC gain.
- ② Sets the digital noise reduction.
- ③ Sets burst suppression. If other peripheral devices (such as a multiplexer) are connected to the system, bursts (distortion of image color) can occur when switching between color and black & white. If this happens, change the BURST setting to “**ON**”.
- ④ Sets the focus when switching to black & white mode.

- 3 **AGC MAX GAIN** setting

Use the cursor button (▲ or ▼) to move the cursor to **AGC MAX GAIN**, and then use the cursor button (◀ or ▶) to select the gain.

**Available settings:** Select the maximum AGC gain from OFF, -6dB, ±0dB, +6dB, +9dB, +12dB or +15dB.

### Setting fixed gain manually

**Set AGC MAX GAIN to “OFF” and then press the SET button.**

The GAIN SETTING screen will appear. You can use this screen to set the gain value manually to within a range of 0 - 30 dB.

### Note:

- If “**OFF**” is selected, no maximum gain will be set.
- If “**OFF**” is selected, the SENSE UP function will be forcibly set to “**OFF**”. However, the setting display will not change.

# LENS SETTING (LENS)

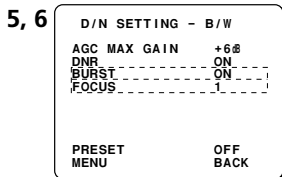
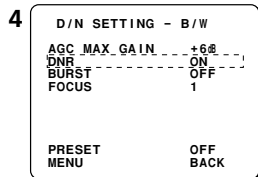

## 4 DNR setting

Use the cursor button (▲ or ▼) to move the cursor to DNR, and then use the cursor button (◀ or ▶) to select the digital noise reduction setting (e.g. ON).

Available settings:

- **ON:** DNR (digital noise reduction) is applied. This reduces interference at low luminance levels.
- **OFF:** DNR is not applied.

### Note:

- Digital noise reduction operates when the gain control increases. In addition, blurring and ghosting of images can occur when moving images are being monitored, and so the resolution is also reduced slightly.
- If AGC MAX GAIN is set to "OFF", DNR will be forcibly set to "OFF".

## 5 BURST setting

Use the cursor button (▲ or ▼) to move the cursor to BURST, and then use the cursor button (◀ or ▶) to select the burst setting (e.g. ON).

Available settings:

- **ON:** The color burst signal is turned on.
- **OFF:** This should normally be set to "OFF".

## 6 FOCUS setting

Use the cursor button (▲ or ▼) to move the cursor to FOCUS, and then use the cursor button (◀ or ▶) to select the focus setting (e.g. 1).

Available settings:

- **1:** Near-infrared wavelength correction is set. (around 900 nm)
- **2:** Visible light spectrum is set.

**Note:** This is set to "1" at the time of shipment from the factory. If the images are out of focus, change it to "2".

 **To close the menu screen or return to the previous screen, select BACK or END for MENU and press the SET button.**

# LENS SETTING (LENS)

🔊 Day/Night mode operation from the system controller

The Day/Night setting (AUTO, COLOR and B/W) can be switched using "CAMERA" operating range of the system controller. Press the following buttons in the order given to change the mode setting.

• **COLOR mode:**

"AUX" → "AUX" → "1" → "Enter" → "+" button

• **B/W mode:**

"AUX" → "AUX" → "2" → "Enter" → "+" button

• **AUTO mode:**

"AUX" → "AUX" → "3" → "Enter" → "+" button

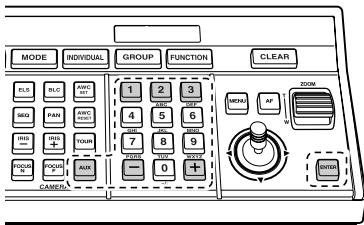

## D VIEW ANGLE setting

The VIEW ANGLE setting should normally be left at "OFF".

1

MAIN MENU		
LANGUAGE	SET	↵
CAMERA ID	OFF	↵
SYNC	INT	↵
PRIVACY_MASK	SET	↵
LENS	SET	↵
MIRROR	OFF	↵
VIEW SETTING	1	↵
OPTION	SET	↵
PRESET	OFF	↵
MENU	END	↵

2

LENS		
FOCUS	MANU	↵
ZOOM	SET	↵
DAY/NIGHT	AUTO	↵
VIEW ANGLE	OFF	↵
PRESET	OFF	↵
MENU	BACK	↵

1 Use the cursor button (▲ or ▼) to select SET for LENS, then press the SET button.

The LENS screen will appear.

2 Use the cursor button (▲ or ▼) to move the cursor to VIEW ANGLE, and then use the cursor button (◀ or ▶) to select the setting (e.g. OFF).

Available settings:

- **OVER:** The image angle for images being monitored is set to 1.05.
- **OFF:** This should normally be set to "OFF".

**Note:** This should normally be set to "OFF". However, vignetting may occur in the corners of the images because of the zoom position. This is not normally a problem, but if you are concerned about it, change the setting to "OVER". The vignetting will then be less apparent.



# MIRROR SETTING

1

MAIN MENU	
LANGUAGE	SET ↵
CAMERA ID	OFF
SYNC	INT
PRIVACY MASK	SET ↵
LENS	SET ↵
MIRROR	OFF ↵
VIEW SETTING	1 ↵
OPTION	SET ↵
PRESET	OFF
MENU	END

- 1 Use the cursor button (▲ or ▼) to move the cursor to **MIRROR**, then use the cursor button (◀ or ▶) to select the mirror image effect (e.g. H).

The image will change as described below each time the cursor button is pressed.

- **OFF**: Normal image
- **H**: Inverted horizontally
- **V**: Inverted vertically
- **HV**: Inverted horizontally and vertically

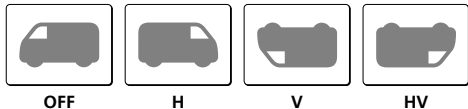

- 2 To return to the normal screen, use the cursor button (▼) to select **END** at the bottom of the screen, then press the **SET** button.

# VIEW SETTING ITEM FLOW

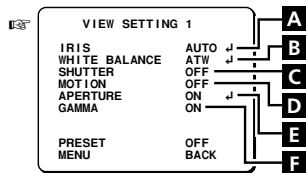
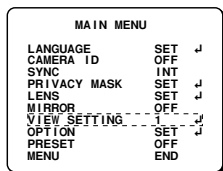

Setting the VIEW SETTING 1 is the camera setting 1. The cursor button can be used (◀ or ▶) to select one of the nine VIEW SETTING patterns (0 – 8).

## A IRIS setting (See p35)

This setting allows selection of IRIS to either autoiris (AUTO) or manual iris (MANU). Default setting is autoiris.

## B WHITE BALANCE adjustment (See p42)

Three white balance methods are available: auto trace white balance (ATW), one-push automatic white balance (AWC), and manual white balance (MWB). Default setting is auto trace white balance.

## C Electronic SHUTTER setting (See p46)

This setting chooses either a fast shutter speed (SHORT) for target objects that may be moving quickly or a slower shutter speed (LONG) for darker target objects.

## D MOTION detector setting (See p48)

This function generates an alarm when a suspicious figure is detected. Each of the settings will enable certain kinds of detection based on the natural image (swaying trees, flickers of light, etc.). It is also possible to enable zooming in on target objects and intruders that have unusual brightness levels (moving, bright) or are fast-moving.

## E Profile compensation setting (APERTURE) (See p54)

This setting emphasizes the target object profile (horizontally or vertically).

## F GAMMA correction setting (See p55)

This setting enables contrast sensitivity to be boosted by controlling the gamma characteristics. Three gamma controls are available: gamma correction (ON), smart gamma correction 1 (SMART 1), and smart gamma correction 2 (SMART 2). Default setting is ON.

# VIEW SETTING ITEM FLOW

## (About creating image setting files in VIEW SETTING)

You can set 9 different patterns with view files. Use the cursor button (◀ or ▶) to change the file number (1) for VIEW SETTING and press the **SET** button. The selected image setting file will appear. Neither the mask function nor the motion detector function can be used with image setting file "0", so they will not appear as options in the screen for pattern 0.

MAIN MENU	
LANGUAGE	SET ↵
CAMERA ID	OFF
SYNC	INT
PRIVACY MASK	SET ↵
LENS	SET ↵
MIRROR	OFF
VIEW SETTING	1 ↵
OPTION	SET ↵
PRESET	OFF
MENU	END



VIEW SETTING 1		
IRIS	AUTO	↵
WHITE BALANCE	ATW	↵
SHUTTER	OFF	
MOTION	OFF	
APERTURE	ON	↵
GAMMA	ON	
PRESET	OFF	
MENU	BACK	

(Screen for image setting 1-8)

VIEW SETTING 0		
IRIS	AUTO	↵
WHITE BALANCE	ATW	↵
SHUTTER	OFF	
MOTION	---	
APERTURE	ON	↵
GAMMA	ON	
PRESET	OFF	
MENU	BACK	

(Screen for image setting 0)

**Note:** When each of the following functions is ON (shown by single circle), it may be possible to use other functions in conjunction with it (shown by double circle). View columns vertically to determine which functions can be used together.

IRIS	AUTO: SENSE UP (activated)	○	×	×	×	×
	MANU: EI (ON)	×	○	×	×	◎
SHUTTER	LONG	×	×	○	×	×
	SHORT	×	×	×	○	◎
MOTION		×	◎	×	◎	○

○: Function is set    ×: Not allowable    ◎: Allowable

# VIEW SETTING

## A IRIS setting

There are 2 possible settings for IRIS, autoiris (AUTO) and manual iris (MANU).

## ■ Autoiris setting (AUTO)

Sets backlight compensation, magnification of electronic sensitivity and iris level.

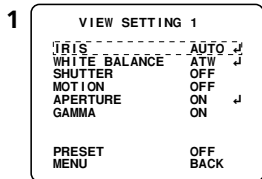

### 1 Use the cursor button (▲ or ▼) to move the cursor to VIEW SETTING, then press the SET button. (e.g. 1)

The VIEW SETTING 1 screen will appear and AUTO for IRIS will be blinking.

#### Available settings:

- **AUTO:** Sets automatic adjustment of iris.
- **MANU:** Sets manual adjustment of iris.

#### Note:

When AUTO is selected, the following 3 types of detailed backlight compensation settings will be available.

- Multi-spot evaluative metering (MULT)
- 5 spot centerweighted average metering (CENT)
- 48 multi-spot metering (MASK)

### 2 Press the SET button.

The IRIS SETTING screen will appear.

# VIEW SETTING

## Backlight compensation additional settings 1

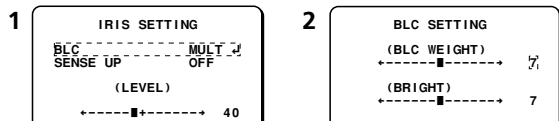

### Backlight compensation settings

- **MULT** (Multi-spot evaluative metering): Evaluates the entire screen and corrects according to the best image obtained.
- **CENT** (5 spot centerweighted average metering): Measures light mainly at the center and corrects according to the best image obtained. (See p37)
- **MASK** (48 multi-spot metering): Covers bright areas such as persons with mask patterns and treats light measurement output as irrelevant. (See p39)

### • Multi-spot evaluative metering (MULT)

- 1 Use the cursor button (**▲** or **▼**) to move the cursor to **BLC**, then use the cursor button (**◀** or **▶**) to select a backlight compensation method. (e.g. **MULT**) Then press the **SET** button.

The BLC SETTING screen will appear.

- 2 Use the cursor button (**◀** or **▶**) to select the value of **BLC WEIGHT**. (Sets backlight and brightness level.)

Available settings: 0 – 15

**Note:** The larger the number, the more backlighting works.

- 3 Use the cursor button (**▲** or **▼**) to move the cursor to **BRIGHT**, and then use the cursor button (**◀** or **▶**) to select the compensation level.

Available settings: 0 – 15

**Note:** When the number becomes larger, it brightens, and the compensation level can be set for the brightness of the backlighting.

- ⓘ** To close the menu screen or return to the previous screen, select **BACK** or **END** for **MENU** and press the **SET** button.

### Note:

- When using multi-spot evaluative metering, the background behind the target object will become very dark. If a target image in the center of the image is too bright while using the multi-spot evaluative metering mode, switch to the **5 spot centerweighted average metering** mode.
- If **DAY/NIGHT** is set to “**AUTO**” and the images are in black & white mode, multi-spot evaluative metering will not operate.

# VIEW SETTING

## Backlight compensation additional settings 2

- 5 spot centerweighted average metering (CENT)

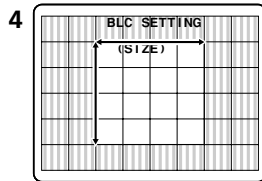
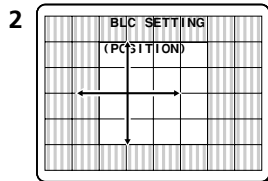
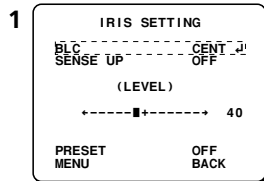

- 1** Use the cursor button (◀ or ▶) to select CENT, then press the SET button.

The BLC SETTING (POSITION) screen will appear.

- 2** Use the cursor button (▲ ▼ ◀ ▶) to shift the position of the central light sensing zone.

The zone can be moved up or down and left or right.

### Note:

- If the zone fills the right side it will become smaller.
- If the zone fills the bottom side it will become smaller.

- 3** Press the SET button.

The BLC SETTING (SIZE) screen will appear.

- 4** Use the cursor button (▲ ▼ ◀ ▶) to adjust the size of the central light sensing zone.

- 5** Press the SET button.

The BLC WINDOW WEIGHTING screen will appear.

# VIEW SETTING

Example of setting the mask in the center weighting position.

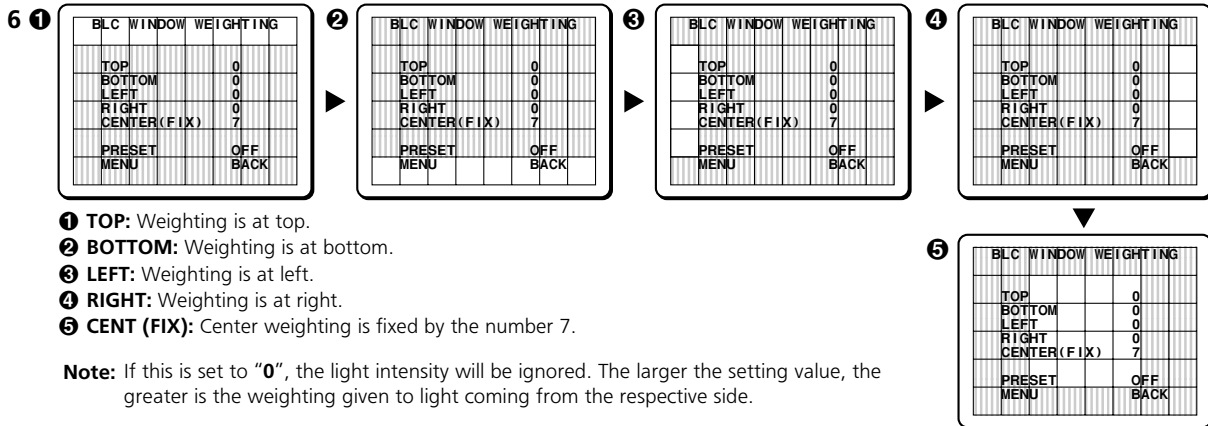

## 6 Use the cursor button (▲ or ▼) to select a zone, then use the cursor button (◀ or ▶) to adjust weighting.

Each setting will change as shown in the illustration.  
The area from each of the zones 0 – 7, except CENTER, can be adjusted.

☞ To close the menu screen or return to the previous screen, select BACK or END for MENU and press the SET button.

# VIEW SETTING

## Backlight compensation additional settings 3

### • 48 multi-spot metering (MASK)

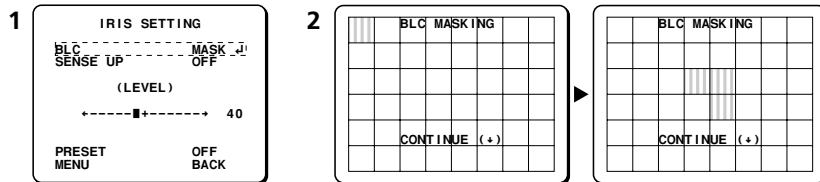

### 1 Use the cursor button (◀ or ▶) to select MASK, then press the SET button.

The BLC MASKING screen will appear and the mask pattern will be blinking.

### 2 Use the cursor button (▲ ▼ ◀ ▶) to move the cursor to move the mask pattern over the area not to be sensed, then press the SET button.

The mask pattern will be set. You can use the same steps to set additional mask patterns.

**Note:** The initial mask pattern is at the upper left of the screen, and it is not set. To clear a mask pattern after it is set, press the **SET** button again.

### 3 Finishing mask pattern setting

Use the cursor button (▲ or ▼) to move a mask pattern to the bottom area of the screen and continue holding it for 3 seconds. The PRESET and MENU items will appear on the screen.

- Use the cursor button (▼) to select BACK for MENU and press the **SET** button. The IRIS SETTING screen will reappear.
- Use the cursor button (▼) to move the cursor to BACK for MENU, use the cursor button (◀ or ▶) to select END, and then press the **SET** button. The normal screen will reappear.



# VIEW SETTING

## ■ SENSE UP setting

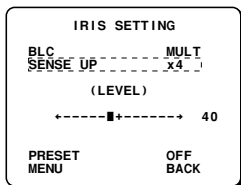

Use the cursor button (▲ or ▼) to move the cursor to SENSE UP, then use the cursor button (◀ or ▶) to select the power of the electronic sensitivity. (e.g. x4)

**Available settings:** OFF, x2, x4, x8, x16, x32

### Note:

- Electronic sensitivity boosting (SENSE UP) automatically lengthens the CCD exposure time in dark situations. Accordingly, do not use for light target objects. Because exposure time is lengthened while in operation, moving target objects may cause conspicuous afterimages and blurs.
- It is not possible to set SENSE UP (activated) or SHUTTER (LONG) when MOTION is set to "ON".
- When SENSE UP is activated for IRIS SETTING, the electronic shutter cannot be forcibly moved.
- If DAY/NIGHT is set to "AUTO" and the images are in color mode, electronic sensitivity boosting will not operate.

☞ To close the menu screen or return to the previous screen, select BACK or END for MENU and press the SET button.

## ■ LEVEL setting

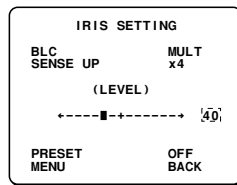

Use the cursor button (▲ or ▼) to move the cursor to LEVEL, then use the cursor button (◀ or ▶) to adjust the iris level.

**Available settings:** 0 – 100

**Note:** The larger the number, the more it brightens.

☞ To close the menu screen or return to the previous screen, select BACK or END for MENU and press the SET button.

# VIEW SETTING

## Manual iris setting

Sets electronic iris ON/OFF, lens aperture and iris level.

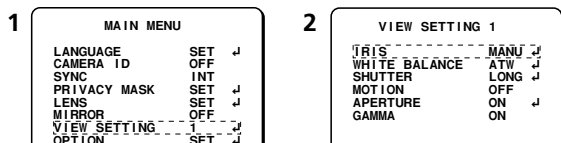

- 1 Use the cursor button (▲ or ▼) to move the cursor to **VIEW SETTING**, then press the SET button. (e.g. 1)

The VIEW SETTING 1 screen will appear.

- 2 Use the cursor button (◀ or ▶) to select **MANU**, then press the SET button.

The IRIS SETTING screen will appear.

### 3 Electronic IRIS setting

Use the cursor button (◀ or ▶) to select **EI**. (e.g. ON)

**Note:** When SENSE UP is activated for IRIS SETTING, the electronic shutter cannot be forcibly moved.

### 4 Lens aperture setting

Use the cursor button (▲ or ▼) to move the cursor to **IRIS STOP**, then use the cursor button (◀ or ▶) to select the value.

**Available settings:** 1 – 17 (Aperture opening)

**Note:**

- The smaller the value the more the aperture closes and the image darkens.
- Changes to the value directly control the aperture of the lens.

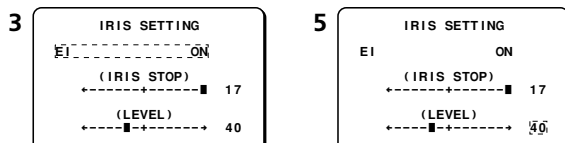

- 5 Use the cursor button (▲ or ▼) to move the cursor to **LEVEL**, then use the cursor button (◀ or ▶) to select the value.

**Available settings:** 0 – 100 (Level of opening)

**Note:**

- The smaller the value the more the video level drops, becoming darker.
- The LEVEL setting controls both AGC circuit gain and shutter speed, changing the amount of exposure.

**To close the menu screen or return to the previous screen, select BACK or END for MENU and press the SET button.**

**Note:**

- If the iris views an unusually bright image, it can cause a smear that cannot be corrected by adjusting the light entering through the lens. In this case, arrange the physical angle of lighting in a way that will prevent on-screen smearing.
- If flickering of the target object occurs because of fluorescent lighting in the camera location, changing to incandescent lighting will prevent the flickering.

# VIEW SETTING

## B WHITE BALANCE adjustment

Adjustments can be made to 3 methods of white balance correction: Auto trace white balance (ATW), one-push automatic white balance (AWC), and manual white balance (MWB).

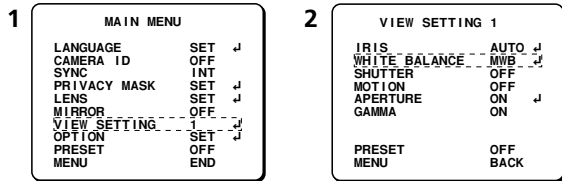

- 1 Use the cursor button (▲ or ▼) to move the cursor to **VIEW SETTING**, then press the **SET** button. (e.g. 1)

The VIEW SETTING 1 screen will appear.

- 2 Use the cursor button (▲ or ▼) to move the cursor to **WHITE BALANCE**, then use the cursor button (◀ or ▶) to select a white balance type "MWB". Then press the **SET** button.

The MWB SETTING screen will appear.

The following methods are available for white balance correction. See the corresponding reference sections for additional setting options.

### Available methods:

#### ■ ATW (Auto trace white balance)

Even when light sources change, automatic adjustment assures capture of most suitable colors. When a bright light source prevents effective white balance, a mask can be placed over the light source. (See p43)

#### ■ AWC (One-push automatic white balance)

White balance is adjusted automatically with one-push activation. AWC is usually set for white target objects (walls, paper, etc.) that do not return color faithfully in the ATW method. (See p45)

#### ■ MWB (Manual white balance)

Fine adjustments for preferred colors can be done manually. This method is preferable when suitable colors cannot be obtained with the ATW method. (See p43)

# VIEW SETTING

## White balance additional settings 1

### ■ MWB setting

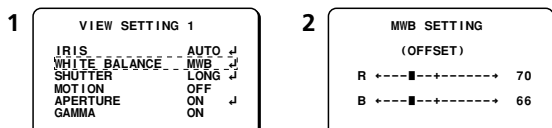

- 1 Use the cursor button (▲ or ▼) to move the cursor to **WHITE BALANCE**, then use the cursor button (◀ or ▶) to select a white balance type (e.g. MWB). Then press the SET button.

The MWB SETTING screen will appear.

- 2 Use the cursor button (◀ or ▶) to adjust the value for "R" (red).

Available settings: 0 – 255

Note: The larger the number, the stronger red becomes.

- 3 Use the cursor button (▲ or ▼) to move the cursor to "B", then use the cursor button (◀ or ▶) to adjust the "Blue" value.

Available settings: 0 – 255

Note: The larger the number, the stronger blue becomes.

- ☰ To close the menu screen or return to the previous screen, select BACK or END for MENU and press the SET button.

## White balance additional settings 2

### ■ ATW setting

Automatic white balance settings are completed when ATW is selected. However, white balance will not be suitably adjusted if a bright light source or an excessively dark area from the environment is in the image. In this case, the bright light source or dark area should be masked so that it will not be detected.

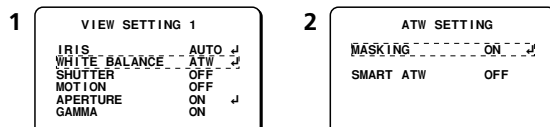

- 1 Use the cursor button (▲ or ▼) to move the cursor to **ATW** for **WHITE BALANCE** and press the SET button.

The ATW SETTING screen will appear.

- 2 Use the cursor button (◀ or ▶) to select **ON** for **MASKING**, then press the SET button.

The ATW MASKING screen will appear with the mask pattern blinking in the upper left corner of the screen.

## VIEW SETTING

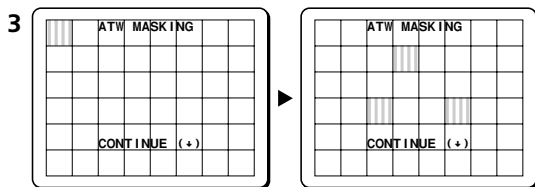

- 3 Use the cursor button (▲ ▼ ◀ ▶) to move the mask pattern over the bright light source, then press the SET button.

Use the same steps to place addition masks as needed.

**Note:** Initial settings place no masks on the screen. To cancel the placement of masks, press the SET button again.

- 4 Use the cursor button (▲ or ▼) to move a mask pattern to the bottom area of the screen and continue holding the cursor button straight down for 3 seconds.

The PRESET and MENU items will appear on the screen. Use the cursor button (▲ or ▼) to select BACK, then press the SET button. The ATW SETTING screen will reappear.

- ☰ To close the menu screen or return to the previous screen, select BACK or END for MENU and press the SET button.

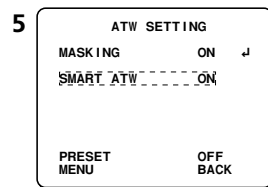
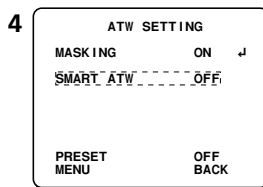

- ☰ SMART ATW setting

If saturation is high or a scene is bright, the most suitable colors may not be obtained. In this case, set the SMART ATW to ON.

- 5 Use the cursor button (▲ or ▼) to move the cursor to SMART ATW, then use the cursor button (◀ or ▶) to set ON.

- ☰ To close the menu screen or return to the previous screen, select BACK or END for MENU and press the SET button.

# VIEW SETTING

## White balance additional settings 3

### ■ AWC setting

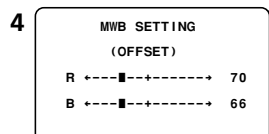
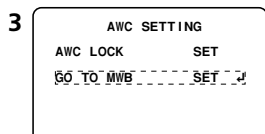
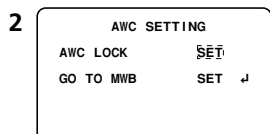
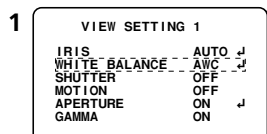

- 1** Use the cursor button (**▲** or **▼**) to move the cursor to **AWC** for **WHITE BALANCE** and press the **SET** button.

The AWC SETTING screen will appear.

- 2** With **SET** blinking for **AWC LOCK**, press the **SET** button.

SET will light and adjustment of white balance will begin. After about 3 seconds, SET will begin blinking again, signaling that adjustment is complete.

#### Note:

For even finer adjustment of coloration, choose SET for GO TO MWB. White balance mode will become MWB for fine adjustment. After fine adjustment with GO TO MWB, the white balance mode will automatically switch to MWB.

**Note:** Full adjustment may not be possible with just one activation of SET for AWC LOCK. In that case, press the **SET** button again.

- 3** **GO TO MWB** setting

Use the cursor button (**▲** or **▼**) to move the cursor to **SET** for **GO TO MWB** and press the **SET** button.

The MWB SETTING screen will appear and the “R” value will be blinking.

- 4** Use the cursor button (**◀** or **▶**) to adjust the value for “R” (red).

Available settings: 0 – 255

**Note:** The larger the number, the stronger red becomes.

- 5** Use the cursor button (**▲** or **▼**) to move the cursor to “B”, then use the cursor button (**◀** or **▶**) to adjust the “Blue” value.

Available settings: 0 – 255

**Note:** The larger the number, the stronger blue becomes.

**To close the menu screen or return to the previous screen, select BACK or END for MENU and press the SET button.**

# VIEW SETTING

## C Electronic SHUTTER setting

Sets the electronic shutter to either the fast shutter speed mode (SHORT) or the slow shutter speed mode (LONG).

### ■ Fast shutter speed (SHORT) mode setting

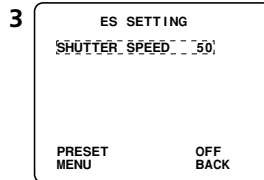
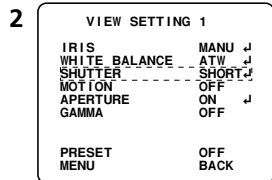

- 1 Use the cursor button (▲ or ▼) to move the cursor to **VIEW SETTING**, then press the SET button. (e.g. 1)

The VIEW SETTING 1 screen will appear.

- 2 Use the cursor button (▲ or ▼) to move the cursor to **SHUTTER**, then use the cursor button (◀ or ▶) to select the speed mode for the electronic shutter. (e.g. SHORT) Then press the SET button.

The ES SETTING screen will appear and 50 (1/50 sec) will be blinking. This setting is suitable for fast moving target objects.

- 3 Use the cursor button (◀ or ▶) to select a electronic shutter speed.

**Available settings:** 50, 120, 250, 500, 1000, 2000, 4000, 10000

**Note:** SHORT mode cannot be set if SENSE UP is activated or IRIS is "ON".

**ⓘ** To close the menu screen or return to the previous screen, select **BACK** or **END** for **MENU** and press the SET button.

# VIEW SETTING

## ■ Slow shutter speed (LONG) mode setting

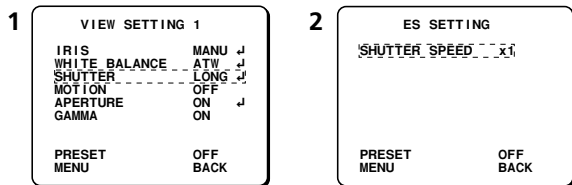

- 1 Use the cursor button (▲ or ▼) to move the cursor to **SHUTTER**, then use the cursor button (◀ or ▶) to select the speed mode for the electronic shutter. (e.g. **LONG**) Then press the **SET** button.

The ES SETTING screen will appear and x1 (1/50 sec) will be blinking. This setting is suitable for dark target objects.

**Note:** When setting the electronic shutter, the **ELS** button on the system controller can only be used to turn the electronic shutter on and off.

- 2 Use the cursor button (◀ or ▶) to select a electronic shutter speed.

**Available settings:** x1, x2, x4, x8, x16, x32 (Field times shown as multiples.)

- ☞ To close the menu screen or return to the previous screen, select **BACK** or **END** for **MENU** and press the **SET** button.

### **Note:**

SHUTTER (LONG) cannot be set if any of the following settings is active.

- **MOTION: ON**
- **IRIS: AUTO item SENSE UP (activated) or MANU item EI (ON)**



# VIEW SETTING

## D MOTION detector setting

This function divides the monitor screen into 48 zones (8 x 6). Based on information from the separate zones, target images that show intruder movements are detected and an alarm is generated. The degree of motion to be detected can be finely set.

### Note:

- Before activating this setting, use the cursor button to select a surveillance location that will not detect motion.
- When SHUTTER speed is in **LONG** mode and IRIS SETTING has **SENSE UP** activated, the MOTION function cannot be turned **ON**.

1

MAIN MENU	
LANGUAGE	SET ↵
CAMERA ID	OFF ↵
SYNC	INT ↵
PRIVACY MASK	SET ↵
LENS	SET ↵
MIRROR	OFF ↵
VIEW SETTING	1 ↵
OPTION	SET ↵
PRESET	OFF ↵
MENU	END ↵

2

VIEW SETTING 1	
IRIS	MANU ↵
WHITE BALANCE	ATW ↵
SHUTTER	LONG ↵
MOTION	ON ↵
APERTURE	ON ↵
GAMMA	ON ↵
PRESET	OFF ↵
MENU	BACK ↵

3

MOTION SETTING	
SIZE	SET ↵
MASKING	ON ↵
SENSITIVITY	SET ↵
ZOOM	OFF ↵
INTERVAL	5S ↵
ALARM SIGN	OFF ↵
PRESET	OFF ↵
MENU	BACK ↵

3

MOTION SIZE					
		V	1		
		H	1		
PRESET				OFF	
MENU				BACK	

### 1 Use the cursor button (▲ or ▼) to move the cursor to **VIEW SETTING**, then press the SET button. (e.g. 1)

The VIEW SETTING 1 screen will appear.

### 2 Use the cursor button (▲ or ▼) to move the cursor to **MOTION**, and then use the cursor button (◀ or ▶) to select **ON**. Then press the SET button.

The MOTION SETTING screen will appear and **SET** for **SIZE** will be blinking.

### 3 MOTION SIZE setting

Sets the target object size desired for detection in the 48 zone screen.

**Press the SET button again.**

The MOTION SIZE screen appears and the "1" for "V" will be blinking.

# VIEW SETTING

## 4 Set the size of the target object desired for detection

### ① Determine the vertical size

Tilt the cursor button to the right (▶).

The "V" value (vertical pattern) will change to "2" and the detection pattern will expand downward. Repeating this motion will expand the pattern in the up and down direction. Tilting the cursor button to the left will reduce the pattern size.

### ② Determine the horizontal size

Use the cursor button (▼) to move the cursor to the "1" for "H", then tilt the cursor button to the right (▶).

The "H" value (horizontal pattern) will change to "2" and the detection pattern will expand to the left. Repeating this motion will expand the pattern in the left and right direction. Tilting the cursor button to the left will reduce the pattern size.

👉 To close the menu screen or return to the previous screen, select BACK or END for MENU and press the SET button.

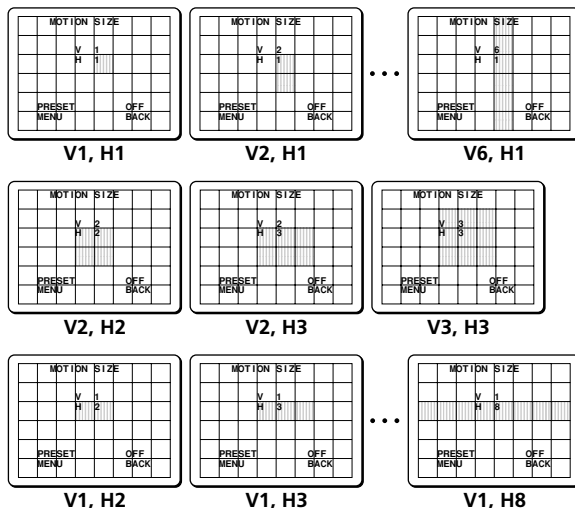

# VIEW SETTING

## ■ MOTION MASKING setting

Masking target objects that are not desired for detection (swaying trees, flickers of light , etc.) will prevent unwanted alarms from being generated. This is done in the MOTION SETTING screen.

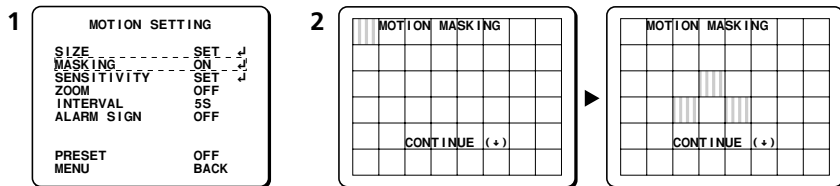

- 1 Use the cursor button (▲ or ▼) to move the cursor to MASKING, and then use the cursor button (◀ or ▶) to select ON. Then press the SET button.**

The MOTION MASKING screen will appear, and the mask pattern will be blinking in the upper left corner of the screen.

- 2 Use the cursor button (▲ ▼ ◀ ▶) to move the mask pattern to the target object that is not to be detected, then press the SET button.**

Repeat these steps to set mask patterns in other locations.

**Note:** To clear a mask pattern, press the **SET** button again on the pattern.

- 3 Finishing motion pattern setting**

Use the cursor button (▲ or ▼) to move a mask pattern to the bottom area of the screen and continue holding it for 3 seconds. The PRESET and MENU items will appear on the screen.

- ☞ To close the menu screen or return to the previous screen, select BACK or END for MENU and press the SET button.**

# VIEW SETTING

## ■ SENSITIVITY setting

Set the degree of sensitivity for motion detection corresponding to MOTION SIZE. Sensitivity can be set so that natural motions on the screen such as wind and light changes will not be detected. When this is necessary, activate the following setting.

MOTION SETTING		SENSITIVITY	
SIZE	SET	MOVE	5
MASKING	ON	Y-LEVEL	5
SENSITIVITY	SET	Y-DIFFER	5
ZOOM	OFF	DURATION	1
INTERVAL	5S	DEMO	OFF
ALARM SIGN	OFF		

Use the cursor button (▲ or ▼) to move the cursor to SENSITIVITY, and then use the cursor button (◀ or ▶) to select SET. Then press the SET button.

The SENSITIVITY screen will appear.

When necessary, adjust the following settings.

### ☞ Motion sensitivity (MOVE) setting

Use the cursor button (▲ or ▼) to move the cursor to MOVE, then use the cursor button (◀ or ▶) to adjust the movement value.

To avoid detection of small movements such as wind, make the value larger.

**Available settings:** 1 – 10

### ☞ Brightness level (Y-LEVEL)

Use the cursor button (▲ or ▼) to move the cursor to Y-LEVEL, then use the cursor button (◀ or ▶) to adjust the brightness level.

When noise from a dark screen is causing erroneous detections, make the value larger.

**Available settings:** 1 – 10

### ☞ Brightness differences (Y-DIFFER)

Use the cursor button (▲ or ▼) to move the cursor to Y-DIFFER, then use the cursor button (◀ or ▶) to adjust the brightness differences.

Changes in brightness can sometimes be mistakenly detected as motion. To avoid detection of the turning on and off of lighting, make the value larger.

**Available settings:** 1 – 10

### ☞ DURATION setting

Use the cursor button (▲ or ▼) to move the cursor to DURATION, then use the cursor button (◀ or ▶) to adjust the detection time duration.

To avoid detecting fast movements, make the value larger.

**Available settings:** 1 – 60

### ☞ Detected motion confirmation mode (DEMO)

Use the cursor button (▲ or ▼) to move the cursor to OFF for DEMO, then use the cursor button (◀ or ▶) to change ON.

When a motion is detected, patterns are shown in that location. While the detected motion is being confirmed, the SENSITIVITY settings are optimized. This mode can only be activated in the SENSITIVITY setting screen.

☞ To close the menu screen or return to the previous screen, select BACK or END for MENU and press the SET button.

# VIEW SETTING

## ■ ZOOM setting

This item is set in the MOTION SETTING screen.

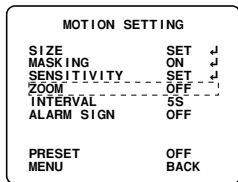

Use the cursor button (▲ or ▼) to move the cursor to ZOOM, then use the cursor button (◀ or ▶) to select the zoom magnification power (e.g. x2).

**Available settings:** OFF, x1.4, x2, x2.8, x4, x6

### Note:

- When a suspicious motion is detected, the camera zooms in according to the set magnification power. The zoom takes effect for 5 seconds and then returns to the previous magnification level.
- The zoom focuses on the center of the screen. If the maximum optical performance is exceeded, zooming will stop at maximum magnification.

🔍 To close the menu screen or return to the previous screen, select BACK or END for MENU and press the SET button.

## ■ INTERVAL setting

This item is set in the MOTION SETTING screen.

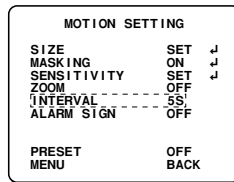

Use the cursor button (▲ or ▼) to move the cursor to INTERVAL, then use the cursor button (◀ or ▶) to select the time interval (e.g. 15S).

**Available settings:** 5S, 10S, 15S, 20S, 30S, 1M, 2M, 3M, 4M, 5M

**Note:** When a motion is detected, no other motions will be detected within the set interval of time.

🔍 To close the menu screen or return to the previous screen, select BACK or END for MENU and press the SET button.

# VIEW SETTING

## ■ ALARM SIGN setting

This item is set in the MOTION SETTING screen.

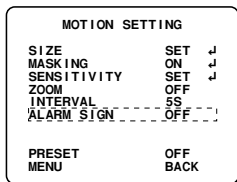

Use the cursor button (▲ or ▼) to move the cursor to **OFF** for **ALARM SIGN**, and then use the cursor button (◀ or ▶) to select **ON**.

### Available settings:

- **ON:** The camera ID display blinks when motion is detected.
- **OFF:** The camera ID display does not blink when motion is detected.

☞ To close the menu screen or return to the previous screen, select **BACK** or **END** for **MENU** and press the **SET** button.

# VIEW SETTING

## E Profile compensation setting (APERTURE)

Set this function to further emphasize the profile of the target object. The amount of compensation can be adjusted for horizontal or vertical directions.

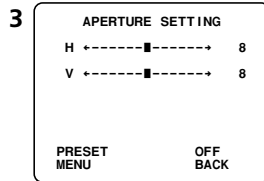
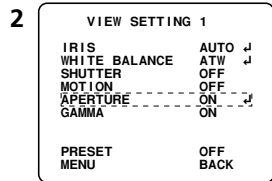
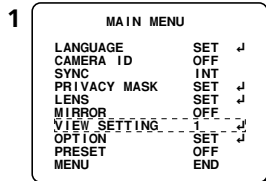

- 1 Use the cursor button (▲ or ▼) to move the cursor to **VIEW SETTING**, then press the **SET** button. (e.g. 1)

The VIEW SETTING 1 screen will appear.

- 2 Use the cursor button (▲ or ▼) to move the cursor to **APERTURE** and then use the cursor button (◀ or ▶) to select **ON**. Then press the **SET** button.

The APERTURE SETTING screen will appear and the “H” value will be blinking.

- 3 Select the amount of profile compensation

Available settings: 1 – 15 (Compensation intensity)

### ① Set the horizontal profile compensation

Use the cursor button (◀ or ▶) to adjust the value for “H” (horizontal).

### ② Set the vertical profile compensation

Use the cursor button (▲ or ▼) to move the cursor to “V” (vertical), then use the cursor button (◀ or ▶) to adjust the value for “V”.

- 🔍 To close the menu screen or return to the previous screen, select **BACK** or **END** for **MENU** and press the **SET** button.

# VIEW SETTING

## F GAMMA correction setting

In addition to turning gamma correction ON or OFF, contrast sensitivity can be boosted at 2 levels.

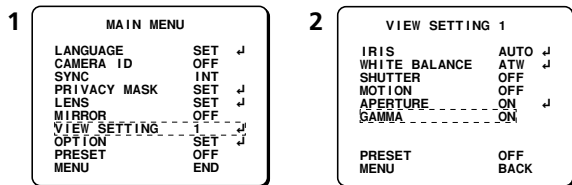

- 1 Use the cursor button (▲ or ▼) to move the cursor to **VIEW SETTING**, then press the **SET** button. (e.g. 1)

The VIEW SETTING 1 screen will appear.

- 2 Use the cursor button (▲ or ▼) to move the cursor to **ON** for **GAMMA**, then use the cursor button (◀ or ▶) to select the gamma correction.

Available settings:

- **OFF:** No gamma correction
- **ON:** Gamma correction ( $\gamma = 0.45$ )
- **SMART 1:** Correction 1
- **SMART 2:** Correction 2 (improves contrast for dark locations)

**Note:** When using SMART 1 or SMART 2, the target object may be too bright, so determine which setting is better for the target object.

 To close the menu screen or return to the previous screen, select **BACK** or **END** for **MENU** and press the **SET** button.



# OPTION SETTING

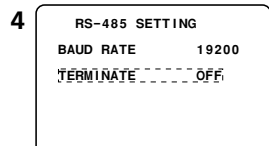
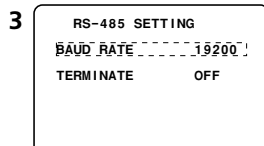
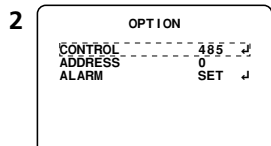
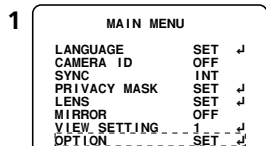

## Option settings

- **CONTROL setting:** This sets whether other peripheral devices can be used to operate the camera by means of the RS-485 interface or a linked coaxial cable.
- **ADDRESS setting:** Use this to set the address for this camera when more than one camera is connected or when other peripheral devices or a system controller have been connected. (See p57)
- **ALARM setting:** This is used for settings related to alarm input and alarm output. In addition, it is also used to force selection of COLOR mode or B/W mode when the DAY/NIGHT setting function is being used. (See p57)

## CONTROL setting

- 1 Use the cursor button (▲ or ▼) to move the cursor to SET for OPTION, then press the SET button.

The OPTION screen will appear.

**Note:** The PRESET ON setting cannot be used when OPTION settings are in use.

- 2 Use the cursor button (▲ or ▼) to move the cursor to 485 for CONTROL, use the cursor button (◀ or ▶) to select the device to be operated (e.g. 485), and then press the SET button.

The RS-485 SETTING screen will appear.

### Available settings:

- **485:** For operation by the System Controller
- **COAX:** For operation of device by linked coax cable.

- 3 Use the cursor button (◀ or ▶) to select 19200 for BAUD RATE.

**Available settings:** 19200, 9600, 4800, 2400

- 4 Use the cursor button (▲ or ▼) to move the cursor to TERMINATE, and then use the cursor button (◀ or ▶) to select the terminate setting.

To close the menu screen or return to the previous screen, select BACK or END for MENU and press the SET button.

# OPTION SETTING

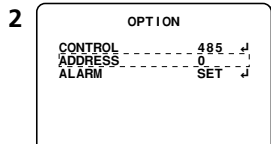
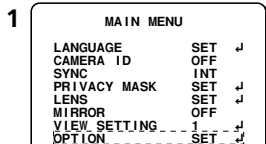

## ■ ADDRESS setting

- 1 Use the cursor button (▲ or ▼) to move the cursor to SET for OPTION, then press the SET button.

The OPTION screen will appear.

**Note:** The PRESET ON setting cannot be used when OPTION settings are in use.

- 2 Use the cursor button (▲ or ▼) to move the cursor to ADDRESS, and then use the cursor button (◀ or ▶) to select the address.

Available settings: 0 (◀) – 127 (▶)

☞ To close the menu screen or return to the previous screen, select BACK or END for MENU and press the SET button.

## ■ ALARM setting

### Ⓐ Alarm input setting (ALARM IN)

Make the following settings for alarm detection.

Connect the external alarm switch to the alarm input terminal on the back of the camera.

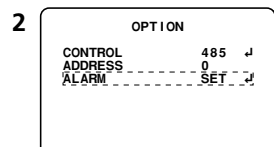
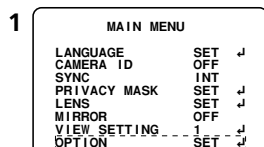

- 1 Use the cursor button (▲ or ▼) to move the cursor to SET for OPTION, then press the SET button.

The OPTION screen will appear.

**Note:** The PRESET ON setting cannot be used when OPTION settings are in use.

- 2 Use the cursor button (▲ or ▼) to move the cursor to SET for ALARM, then press the SET button.

The ALARM SETTING screen will appear.

### 3 Alarm input setting

Use the cursor button (▲ or ▼) to move the cursor to ALM for ALARM IN, and then use the cursor button (◀ or ▶) to set the input (e.g. ALM).

# OPTION SETTING

3, 4

ALARM SETTING	
ALARM IN	ALM
POLARITY	NO
MOTION	OFF
DURATION	5S
ALARM OUT	OFF
POLARITY	NO
ALARM TIME	5S
LINE OUT	OFF

## 4 POLARITY setting

Use the cursor button (▲ or ▼) to move the cursor to **POLARITY**, then use the cursor button (◀ or ▶) to select "NO" or "NC".

Available settings:

- **NO**: Normal open (Normally open so closed condition is detected as input.)
- **NC**: Normal closed (Normally closed so open condition is detected as input.)

## 5 Motion sensor input setting (MOTION)

Use the cursor button (▲ or ▼) to move the cursor to **MOTION**, then use the cursor button (◀ or ▶) to select the input.

Matches information from the camera's motion sensor and the external alarm and outputs it.

Available settings:

- **OFF**: Does not output a motion sensor alarm.
- **AND**: Outputs an alarm when an external alarm input and motion sensor alarm are detected at the same time.

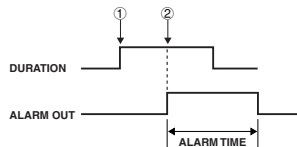

① External alarm input

② Motion sensor detection

- **OR**: Outputs an alarm if either an external alarm or a motion sensor alarm is detected.

## 6 Alarm duration setting (DURATION)

Use the cursor button (▲ or ▼) to move the cursor to **DURATION**, then use the cursor button (◀ or ▶) to select the alarm duration.

Set the duration for the following alarm input reception.

Available settings: 5S (default setting), 10S, 15S, 20S, 30S, 1M, 2M, 3M, 4M, 5M

- ☞ To close the menu screen or return to the previous screen, select **BACK** or **END** for **MENU** and press the **SET** button.

# OPTION SETTING

## B Color/black & white selection setting (DAY/NIGHT)

The ALARM IN terminal on the rear panel can be used to force the image mode to color mode or black & white mode. Use this setting when using this terminal to force the mode selection. However, when this setting is being used, external alarm input cannot be received.

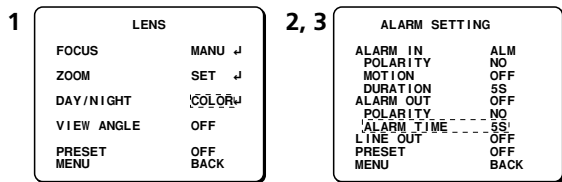

### 1 Set DAY/NIGHT in the LENS setting screen to "COLOR".

First change the DAY/NIGHT setting in the LENS setting screen to "COLOR". (See p23)

### 2 Color/black & white selection setting

Use the cursor button (▲ or ▼) to move the cursor to **ALM** for **ALARM IN**, and then use the cursor button (◀ or ▶) to set the input (e.g. **COLOR**).

- **ALM:** The control terminal (ALARM IN) is used for alarm input.
- **COLOR:** The control terminal (ALARM IN) is used for color/black & white selection input. External operations can then be used to forcibly switch the mode to color mode or black & white mode.

### 3 POLARITY setting

Use the cursor button (▲ or ▼) to move the cursor to **POLARITY**, then use the cursor button (◀ or ▶) to select "NO" or "NC".

Available settings:

- **NO:** Normally open (Normally open, and mode switches between color and black & white when closed)
- **NC:** Normally closed (Normally closed, and mode switches between color and black & white when opened)

POLARITY setting	Between ALARM IN - COM terminals	Mode after selection
When set to NO	Open	COLOR
	Closed	B/W
When set to NC	Open	COLOR
	Closed	B/W

Note:

- If DAY/NIGHT has been set to "COLOR", color/black & white selection will not be possible.
- If COLOR is selected, settings relating to external alarm input will not be displayed, and it will not be possible to receive external alarm inputs.
- The color/black & white selection setting is applied from the point after the menu is exited.

# OPTION SETTING

## ③ Alarm output setting (ALARM OUT)

1

ALARM SETTING	
ALARM IN	ALM
POLARITY	NO
MOTION	OFF
DURATION	5S
ALARM OUT	OFF
POLARITY	NO
ALARM TIME	5S
LINE OUT	OFF

2

ALARM SETTING	
ALARM IN	ALM
POLARITY	NO
MOTION	OFF
DURATION	5S
ALARM OUT	OFF
POLARITY	NO
ALARM TIME	5S
LINE OUT	OFF

3

ALARM SETTING	
ALARM IN	ALM
POLARITY	NO
MOTION	OFF
DURATION	5S
ALARM OUT	OFF
POLARITY	NO
ALARM TIME	5S
LINE OUT	OFF

### 1 ALARM OUT setting

Use the cursor button (▲ or ▼) to move the cursor to ALARM OUT, then use the cursor button (◀ or ▶) to select "ON" or "OFF".

#### Available settings:

- **ON:** Output an alarm (for activation of buzzer or lamp)
- **OFF:** Does not output an alarm

### 2 POLARITY setting

Use the cursor button (▲ or ▼) to move the cursor to POLARITY, then use the cursor button (◀ or ▶) to select "NO" or "NC".

#### Available settings:

- **NO:** Normal open (Normally open so closed condition is detected as input.)
- **NC:** Normal closed (Normally closed so open condition is detected as input.)

### 3 ALARM TIME setting

Use the cursor button (▲ or ▼) to move the cursor to ALARM TIME, then use the cursor button (◀ or ▶) to select the amount of time for external alarm output.

**Available settings:** 5S, 10S, 15S, 20S, 30S, 1M, 2M, 3M, 4M, 5M

☞ To close the menu screen or return to the previous screen, select BACK or END for MENU and press the SET button.

## OPTION SETTING

### ④ Operation of alarm signal output to the System Controller setting (LINE OUT)

Outputs alarm signal to the System Controller. The ALARM lamp on the System Controller will blink when it receives an alarm signal. An alarm list can be displayed to show information such as date/time alarm was received, the device sending the alarm and the alarm type.

1

ALARM SETTING	
ALARM IN	ALM
POLARITY	NO
MOTION	OFF
DURATION	5S
ALARM OUT	OFF
POLARITY	NO
ALARM TIME	5S
LINE_OUT	OFF

Use the cursor button (▲ or ▼) to move the cursor to LINE OUT, then use the cursor button (◀ or ▶) to select "ON" or "OFF".

#### Available settings:

- **ON:** Outputs alarm signal to the System Controller
- **OFF:** Does not output alarm signal to the System Controller

☞ To close the menu screen or return to the previous screen, select BACK or END for MENU and press the SET button.

# MENU FLOW

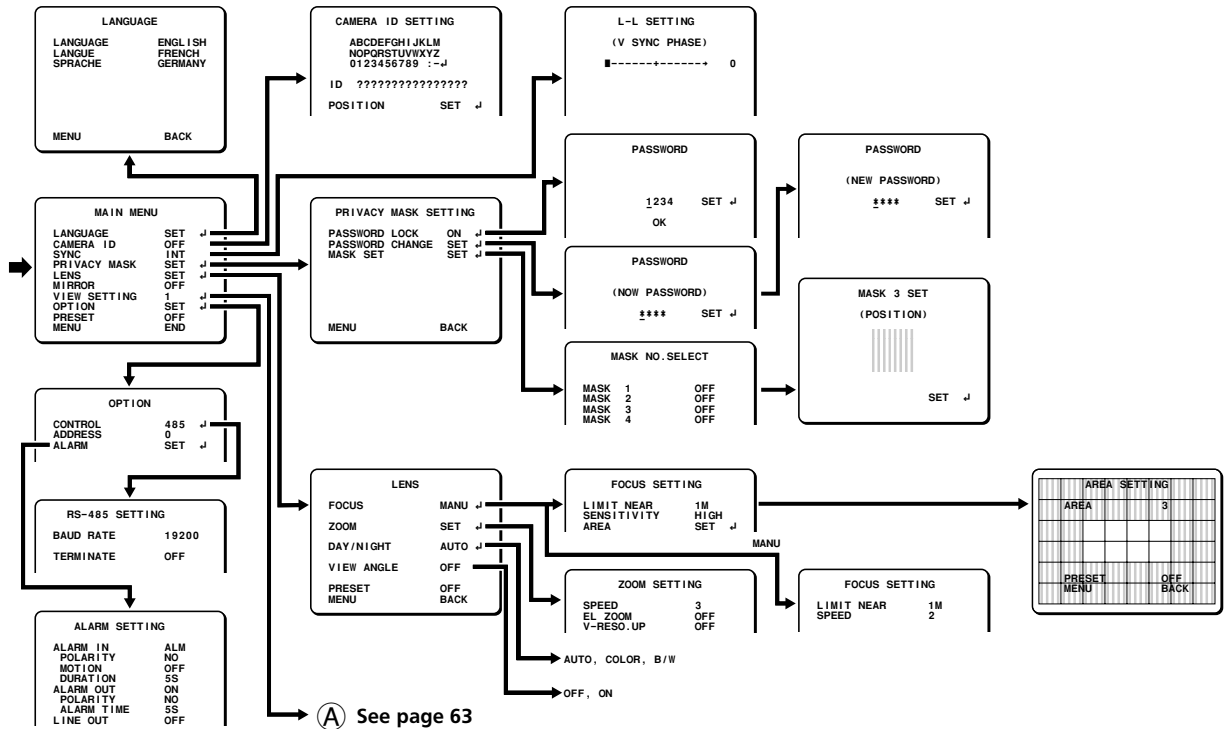

Ⓐ See page 63

# MENU FLOW

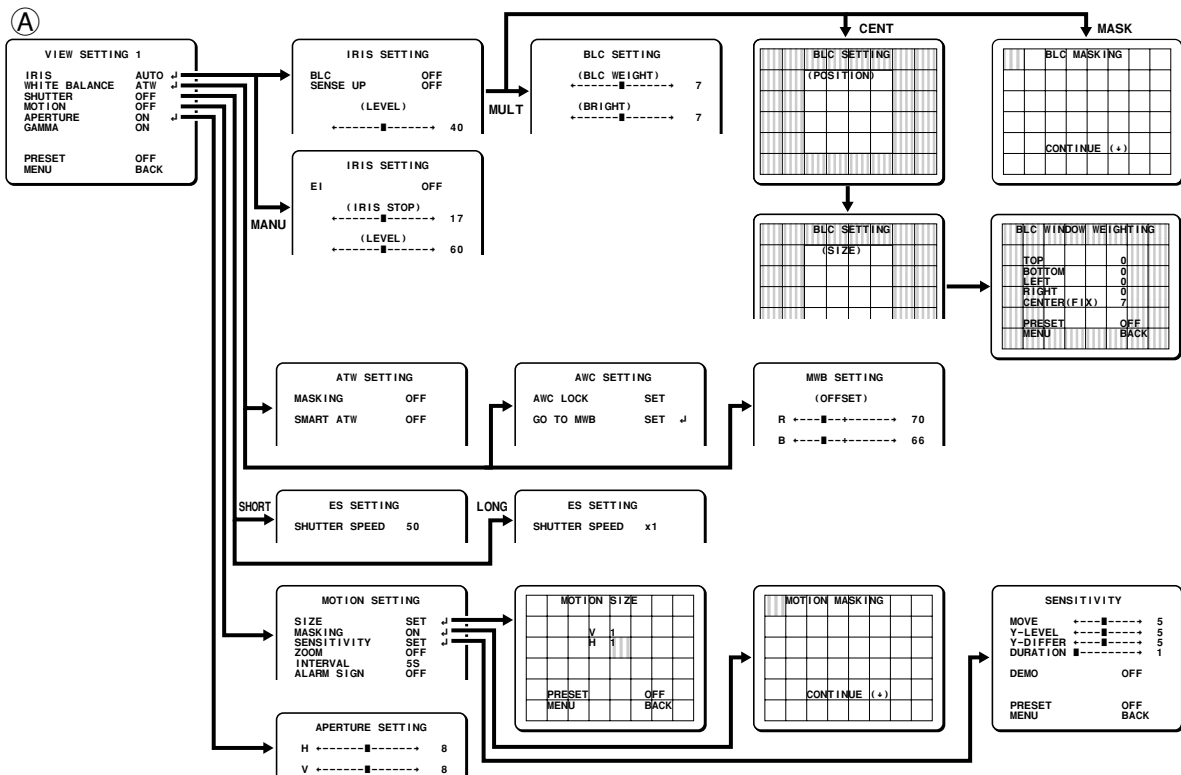



# SPECIFICATIONS

<b>Pickup device</b>	: 1/4"
<b>Effective pixels</b>	: 752 (H) x 582 (V)
<b>Horizontal resolution</b>	: Over 520 TV lines
<b>Lens</b>	: x22 zoom lens, f=3.6 – 79.2mm (F1.6 – 3.8) Electronic zoom and gearing Zoom speed setting possible
<b>Electronic zoom</b>	: 16 power (combined with optic zoom gives 352 power max) Max zoom magnification setting possible Vertical resolution ON/OFF setting
<b>Autofocus</b>	: AUTO/MANUAL AF area setting possible (3 step)
<b>Iris control</b>	: AUTO/MANUAL, 1/2 EV steps
<b>Synchronization method</b>	: Internal synchronization/Line lock, V phase adjustment possible
<b>Lowest image illumination:</b>	1.2 lx (F1.6, AGC gain at maximum, COLOR mode) 0.06 lx (F1.6, B/W mode) 0.04 lx (F1.6, x32 electronic sensitivity increased, COLOR mode) 0.002 lx (F1.6, x32 SENSE UP, B/W mode)
<b>S/N</b>	: Over 48dB
<b>Backlight compensation</b>	: Multi-spot evaluative metering 5 spot centerweighted average metering 48 multi-spot metering
<b>Day/Night</b>	: AUTO / COLOR / B/W settings available
<b>Electronic shutter</b>	: ● Fast shutter speed mode (SHORT); 1/50, 1/120, 1/250, 1/500, 1/1000, 1/2000, 1/4000, 1/10000 ● Slow shutter speed mode (LONG); x1, x2, x4, x8, x16, x32
<b>Electronic sensitivity boosting</b>	: AUTO/OFF, works with auto iris Up to x32 max setting possible
<b>White balance</b>	: ATW/AWC/MWB
<b>AGC gain</b>	: OFF/-6/±0/+6/+9/+12/+15dB

<b>Motion detector</b>	: ON/OFF, ON allows setting of detection patterns on a 48 zone screen for 6 motion settings (size, masking, sensitivity, zoom, interval, alarm sign)
<b>Privacy masking</b>	: ON/OFF, max of 4 masked locations Password lock possible
<b>Alarm input/output (back panel control terminals)</b>	: Alarm input: 1 (for external alarm switch) Alarm output: 1 (for sending a signal to the system controller or an alarm detection device such as a buzzer)
<b>Mirror image effect</b>	: Horizontally (H), vertically (V), horizontally and vertically (HV)
<b>Camera ID</b>	: ON/OFF, 16 characters
<b>View settings</b>	: 9 (0 – 8) screen files can be established, and each file can set 7 capturing characteristics such as iris
<b>Communications</b>	: Coaxial control, RS-485
<b>Operational temperature/humidity</b>	: -10 – +50° C/below 90% RH
<b>Power source</b>	: 24 V AC, 50 Hz/12 – 15 V DC
<b>Power consumption</b>	: 4.5 W
<b>Weight</b>	: 380 g

## SERVICE

This camera is a precision instruments and if treated with care, will provide years of satisfactory performance. However, in the event of a problem, the owner is advised not to attempt to make repairs or open the cabinet. Servicing should always be referred to your dealer or Sanyo Authorized Service Centre.

# SPECIFICATIONS

## ■ Dimensions

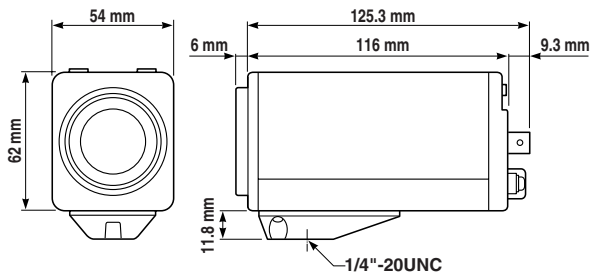

External appearance and specifications subject to change without notice.

Printed on recycled paper  
Gedruckt auf recyceltem Papier  
Imprimé sur du papier recyclé  
印刷在再生纸上

1AC6P1P2628--  
L5AD2/XE(1102KP-SY)

**SANYO**

---

**Sanyo Electric Co, Ltd.**  
Printed in Japan