

INSTRUCTION MANUAL

VQC-801P VQM-801P

Quad Compressor	English	GB
Quad Compressor	Deutsch	D
Compresseur quadruplex	Français	F
Compresor cuádruple	Español	E
Compressore per quadranti	Italiano	I

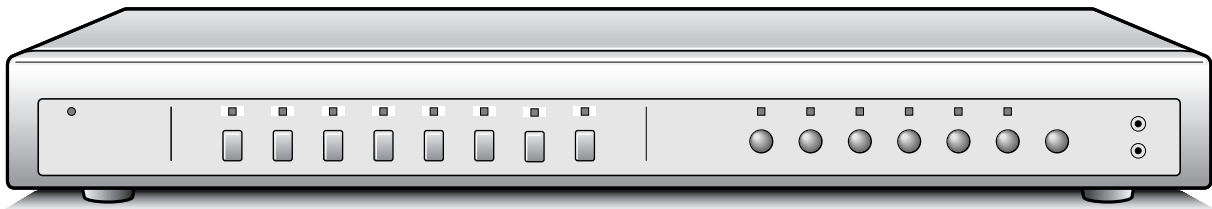

About this manual

- Before installing and using this unit, please read this manual carefully. Be sure to keep it handy for later reference.
- This manual gives basic connections and operating instructions for 2 models (Colour VQC-801P, B/W VQM-801P).

Über diese Anleitung

- Lesen Sie bitte diese Bedienungsanleitung vor der Installation und der Verwendung des Gerätes sorgfältig durch. Bewahren Sie die Anleitung zum späteren Nachschlagen auf.
- In dieser Anleitung werden die Anschlüsse und die Bedienungsanleitungen für 2 Modelle (Farbe VQC-801P, Schwarzweiß VQM-801P) beschrieben.

À propos de ce manuel

- Avant d'installer et d'utiliser cet appareil, veuillez lire ce manuel attentivement. Assurez-vous de le garder à portée de la main pour référence ultérieure.
- Ce manuel couvre les instructions de branchement et d'utilisation de base pour deux modèles (couleur VQC-801P, noir et blanc VQM-801P).

Acerca de este manual

- Antes de instalar y usar este aparato, lea detenidamente este manual. Asegúrese de guardarlo a mano para futuras referencias.
- Este manual le indica las conexiones básicas y las instrucciones de funcionamiento de dos modelos (Color VQC-801P, Blanco y negro VQM-801P).

Nota su questo manuale

- Leggere attentamente questo manuale prima di passare all'installazione ed all'uso di questo apparecchio.
- Questo manuale contiene istruzioni per i principali collegamenti ed il funzionamento di due modelli (il modello a colori VQC-801P, ed il modello in bianco e nero VQM-801P).

PRECAUTION

WARNING: TO REDUCE THE RISK OF FIRE OR ELECTRIC SHOCK, DO NOT EXPOSE THIS APPLIANCE TO RAIN OR OTHER MOISTURE.

To avoid electrical shock, do not open the cabinet.

Refer servicing to qualified personnel only.

If the power supply cord (AC power cord) of this appliance is damaged, it must be replaced. Return to a SANYO Authorised Service Centre for replacement of the cord.

Location

For safe operation and satisfactory performance of your unit, keep the following in mind when selecting a place for its installation:

- Shield it from direct sunlight and keep it away from sources of intense heat.
- Avoid dusty or humid places.
- Avoid places with insufficient ventilation for proper heat dissipation. Do not block the ventilation holes at the top and bottom of the unit. Do not place the unit on a carpet because this will block the ventilation holes.
- Install the unit in a horizontal position only.
- Avoid locations subject to strong vibrations.
- Avoid moving the unit between cold and hot locations.
- Do not place the unit directly on top of a monitor TV, as this may cause interference.

Avoiding Electrical Shock and Fire

- Do not handle the power cord with wet hands.
- Do not pull on the power cord when disconnecting it from an AC wall outlet. Grasp it by the plug.
- If any liquid is spilled on the unit, unplug the power cord immediately and have the unit inspected at a factory-authorized service centre.
- Do not place anything directly on top of this unit.

SERVICE

This unit is a precision instruments and if treated with care, will provide years of satisfactory performance. However, in the event of a problem, the owner is advised not to attempt to make repairs or open the cabinet. Servicing should always be referred to your dealer or Sanyo Authorized Service Centre.

CAUTION

Danger of explosion if battery is incorrectly replaced.

Replace only with the same or equivalent type recommended by the manufacturer.

Discard used batteries according to the manufacture's instructions.

CONTENTS

PARTS NAMES	3
FRONT PANEL	3
REAR PANEL	4
CONNECTION	5
RECORDING LIVE PICTURES IN QUAD SCREEN DISPLAY MODE ONLY CONNECTIONS	5
REMOTE CONTROLLER CIRCUIT CONNECTIONS	6
INSTALLING THE RACK MOUNTING BRACKETS (SOLD SEPARATELY)	6
BASIC OPERATIONS	7
MODE SWITCHING	7
SECURITY LOCK FUNCTION	8
SETTINGS BACKUP FUNCTION	8
RESET FUNCTION	8
LIVE PICTURE MODE	9
LIVE PICTURE MODE OPERATIONS STEPS	9
QUAD SCREEN OPERATIONS	10
FULL SCREEN OPERATIONS	13
VCR PLAYBACK MODE	14
QUAD SCREEN OPERATIONS	14
FULL SCREEN OPERATIONS	14
MENU SETTING MODE	15
LANGUAGE SETTING	16
CLOCK AND SUMMER TIME SETTING	17
CAMERA TITLE SETTING	18
ALARM SETTING	19
VIDEO SENSOR SETTING	20
VIDEO SENSOR ALARMS	20
TIMER SETTING	21
CLOCK, TITLE DISPLAY AND MONITOR SETTINGS	22
VIDEO LOSS SETTING AND COMPUTER CONTROL SETTING	25
ALARM DATA DISPLAY	26
SETTING UP THE VCR SIGNAL OUTPUT (SW IN) AUTOMATIC SWITCHING SPEED	26
ALARMS OPERATIONS	27
EXTERNAL ALARMS	27
VIDEO LOSS ALARM	27
VIDEO SENSOR ALARMS	27
RS232C CONTROL	28
CONNECTION	28
INTERFACE SPECIFICATIONS	28
COMMANDS	28
SPECIFICATIONS	32

FEATURES

- Date/Time function
- Up to 10 characters title function
 - Title and time display can be turned on/off
 - Title and time display position can be selected
- Up to 100 alarm recordings log on-screen display
- Timer function allowing to record only when necessary (night and/or day) for each camera
 - Sequential speed for each camera can be adjusted
 - Important cameras to be displayed in quad screen can be selected
- Video loss warning function that can switch the display to colour bars or to a frozen image
- 3 alarm functions
 - External alarm, video loss alarm, video sensor alarm
- Security lock function
- Computer control function using an RS232C connection

ACCESSORIES

- ① Power cord x1
- ② Fixer Power cord tie x1
- ③ Rack mounting brackets bolts x4

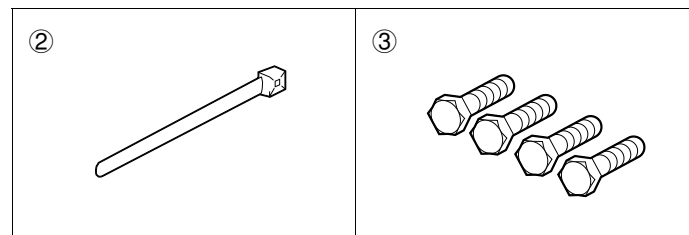

PARTS NAMES

FRONT PANEL

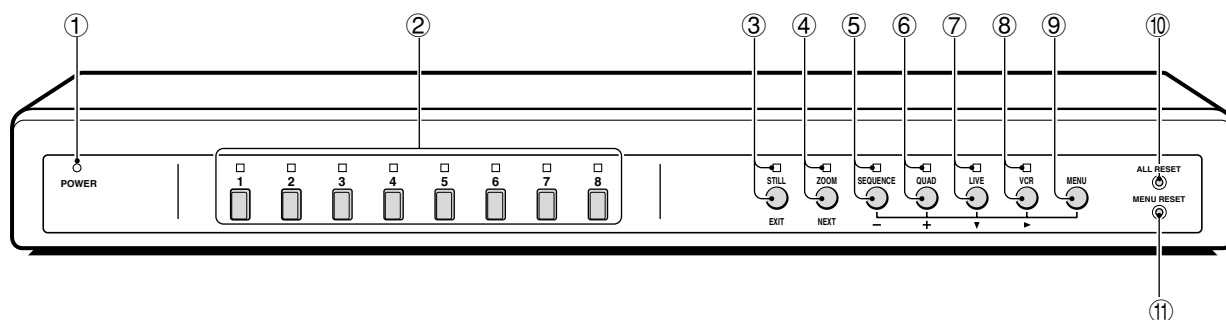

This unit is not equipped with a power switch. The power is turned on/off when the supplied power cord is connected/disconnected at the power source.

- ① **POWER indicator**
- ② **Camera select buttons and camera indicators**
Use these buttons to select the picture from the corresponding camera. When a camera is selected, the corresponding indicator will light.
- ③ **STILL button and indicator**
In live picture quad screen display mode, press this button to set the freeze mode.
- ④ **ZOOM button and indicator**
In live picture quad screen display mode, press this button to set the 2x zoom in mode.
- ⑤ **SEQUENCE button and indicator**
Press this button for an automatic sequential quad screen or full screen display of the pictures.
- ⑥ **QUAD button and indicator**
In live picture mode, press this button repeatedly to switch between quad screens A and B.
- ⑦ **LIVE button and indicator**
Press this button to select the live input mode.
- ⑧ **VCR button and indicator**
Press this button to select the VCR playback input mode.
- ⑨ **MENU button (see page 7)**
Press this button to display the menus. Press repeatedly to select the different menus in order. Buttons ③ to ⑧ are used for menu control.
- ⑩ **ALL RESET button (see page 8)**
- ⑪ **MENU RESET button (see page 8)**

PARTS NAMES

REAR PANEL

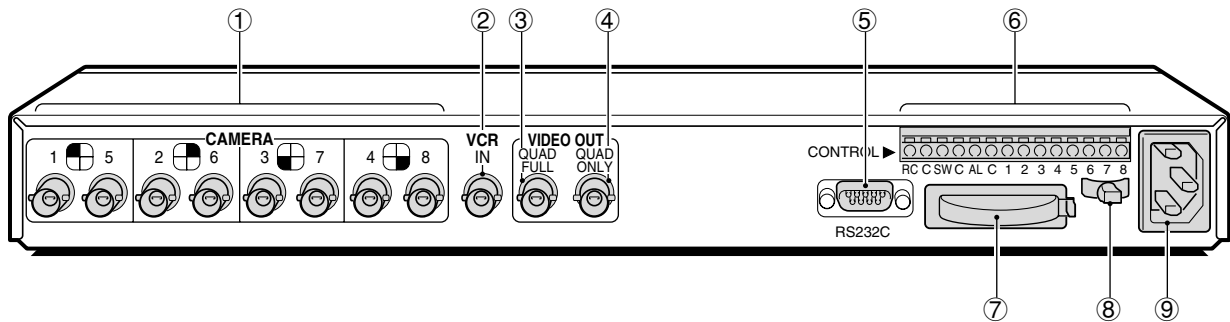

- ① **CAMERA input terminals (1 – 8)**
- ② **VCR IN (Video cassette recorder input) terminal**
- ③ **VCR OUT QUAD FULL (Video signal output) terminal**
Output in quad screen and full screen display modes.
- ④ **VCR OUT QUAD ONLY (Video signal output) terminal**
Output only in quad screen display mode.
However, the output display mode at this terminal can be switched from quad screen mode only to quad screen and full screen display modes (see (MONITOR SET) on page 22, and Tables 1 and 2 on pages 23 and 24).
- ⑤ **RS232C (RS-232C) terminal**
To control this unit using a personal computer, connect the computer serial terminal to this terminal using a 9-pin D-SUB cable (sold separately).
- ⑥ **CONTROL terminal**
- ⑦ **Battery compartment**
- ⑧ **Power cord holder**
Using the supplied tie, attach the power cord to the holder as illustrated.

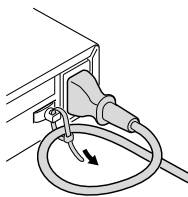

- ⑨ **AC Power socket**
Insert the power cord female plug firmly into this socket. When the other plug of the power cord is connect to a live power source, the POWER indicator on the front panel will light.

(RS232C terminal)

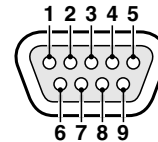

Pin No.	Signal	Function	Signal direction
1	–	–	–
2	RXD	Data reception	Computer → This unit
3	TXD	Data transmission	This unit → Computer
4	DTR	Normally "H"	
5	GND	Common	–
6	–	–	–
7	–	–	–
8	CTS	No reception	This unit → Computer
9	–	–	–

(CONTROL terminal)

Pin	Signal
RC	Remote input
C	Common
SW	Switching input (DC 5V)
C	Common
AL	Alarm input (DC 5V)
C	Common
1	Alarm input 1
2	Alarm input 2
3	Alarm input 3
4	Alarm input 4
5	Alarm input 5
5	Alarm input 6
7	Alarm input 7
8	Alarm input 8

CONNECTION

Before making any connection, make sure all the devices are turned off.

Before making the connections, please refer to the instruction manual accompanying each device.

If the devices are not connected properly, that may cause a fire and/or damages.

RECORDING LIVE PICTURES IN QUAD SCREEN DISPLAY MODE ONLY CONNECTIONS

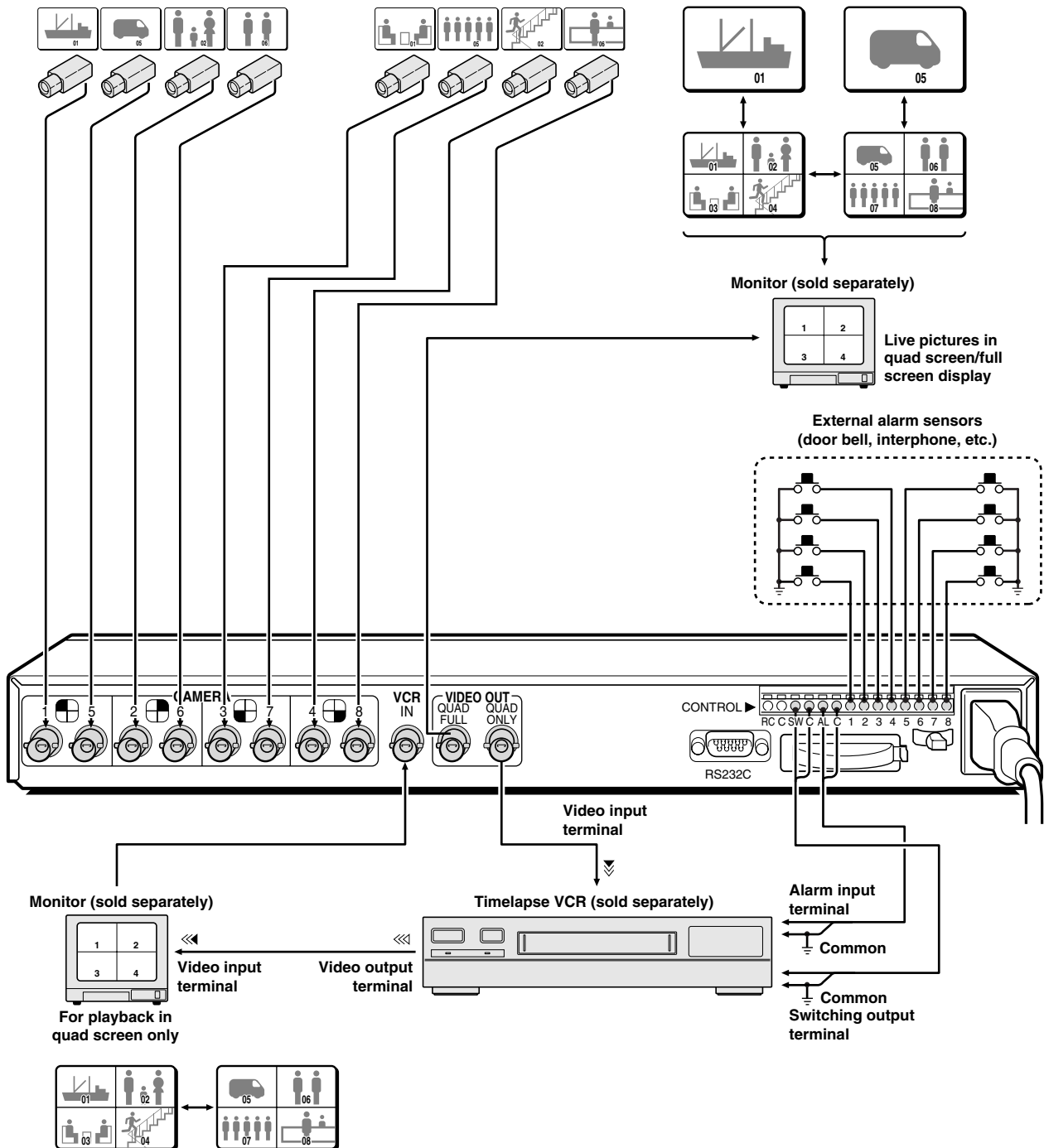

NOTE:

With model VQM-801P, use black and white cameras only. If colour cameras are used, that may cause image beat, etc.

CONNECTION

REMOTE CONTROLLER CIRCUIT CONNECTIONS

Use the layout below to make a remote controller and make the connections to the remote input pins (RC, C) of the CONTROL terminal as indicated. This will permit remote controlled operation of this unit. (make contact LOW input)

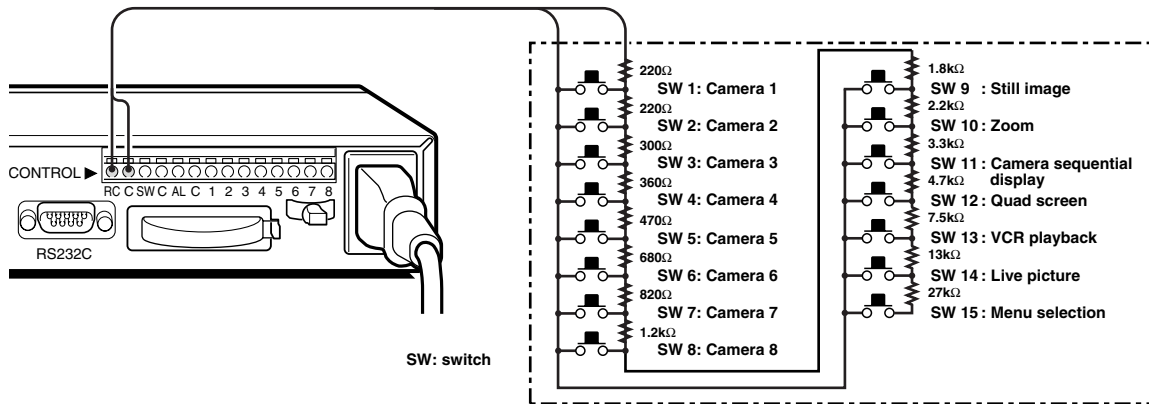

INSTALLING THE RACK MOUNTING BRACKETS (SOLD SEPARATELY)

To mount this unit onto a rack, please use the rack mount hardware (model VA-RACMK 1) sold separately.

- 1** Insert the head of two of the supplied bolts into the keyhole opening on the side of the unit.
Insert the head of the bolt in the larger side, then slide it to the smaller side of the opening.
 - 2** Align the slot on the mounting bracket with the two bolts.
Make sure the bolts have not moved from their position, then place a flat washer, a locking washer, and fix with a nut.
- NOTE:**
Make sure to use the bolts provided with this unit, as the bolts provided with the rack mount hardware are too short.
- 3** Install the second mounting bracket on the opposite side, then attach the unit onto the rack using the rack mount bolts.

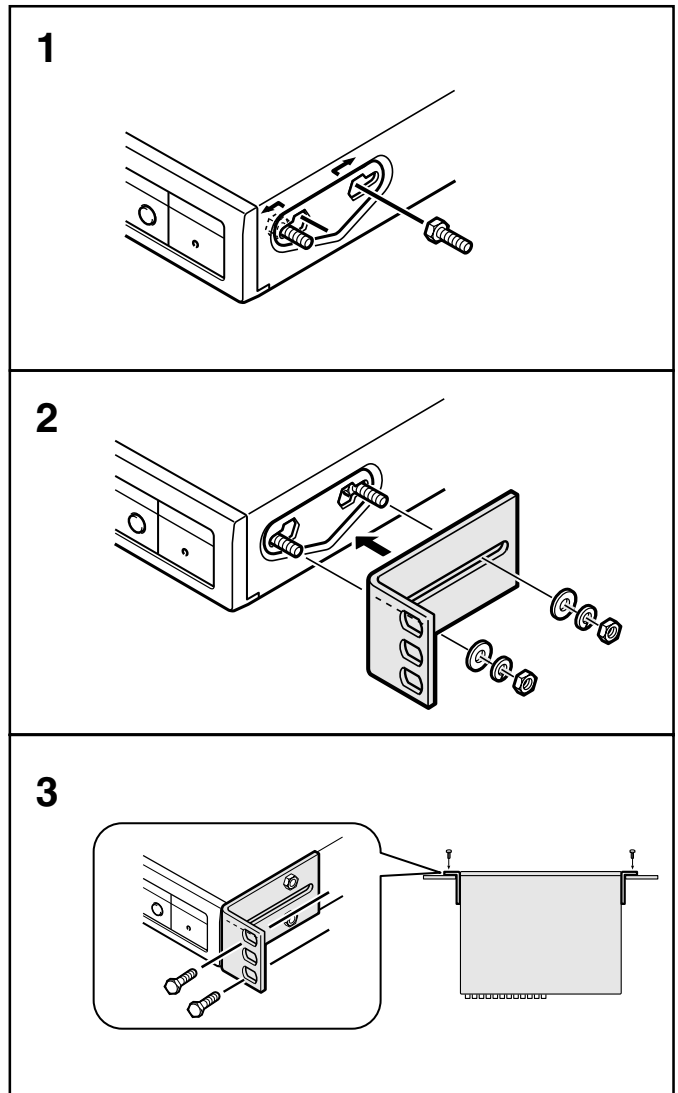

BASIC OPERATIONS

MODE SWITCHING

When the unit is connected to a power source, the default display mode will be: live picture from the four cameras 1 – 4 in a quad screen. You can use the VCR, LIVE and MENU buttons to switch to the desired mode (see below for further information).

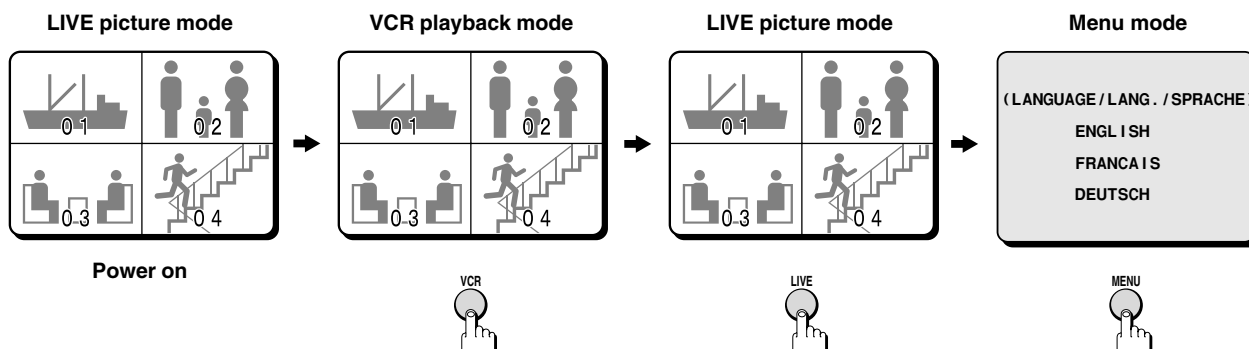

Live Picture Mode (see page 9)

When the **LIVE** button is pressed, the live (direct) picture from cameras 1 – 4 connected to the camera input terminals on the unit rear panel, will be displayed. While in live picture mode you can use the still and zoom functions.

NOTE:

- The unit will automatically start in the live picture or VCR playback display mode (quad screen or full screen display) last selected. Therefore, when a mode is selected, the display mode will remain the same.
- In quad screen mode, if a camera is not connected at one of the input terminals, "NO VIDEO" will be displayed on the monitor screen.



VCR Playback Mode (see page 14)

Start playback on the VCR. If the video signal is correctly recorded, the VCR playback image will be displayed when the **VCR** button is pressed.

Menu Setting Mode (see page 15)

Press the **MENU** button to display the menu. The buttons used for menu control are indicated below.

Menu control buttons

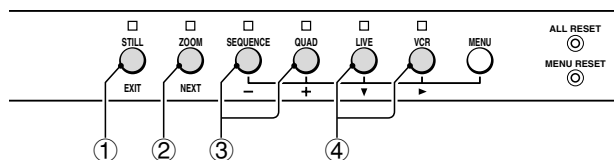

① EXIT (STILL) button

To exit the menu mode.

② NEXT (ZOOM) button

To select a sub-menu in order to set the title position, etc. Press the **NEXT** button to switch between the menu and the sub-menu.

③ +, – (QUAD, SEQUENCE) buttons ... Press repeatedly

Use these buttons to select numbers, letters, symbols.

- + button: for forward selection
- – button: for backward selection

④ ►, ▼ (VCR, LIVE) button ... Press repeatedly

Use these buttons to move the cursor to the right or down.

- ► button: will move the cursor towards the right.
- ▼ button: will move the cursor down.

BASIC OPERATIONS

SECURITY LOCK FUNCTION

This function lets you lock the camera live picture mode or VCR playback mode, so that it cannot be switched to another mode.

Security lock

Press the **LIVE** or the **VCR** button for about 3 seconds.

The buzzer will be heard and all the buttons will be locked. If a button is pressed by mistake, the buzzer is heard and the corresponding function will not operate.

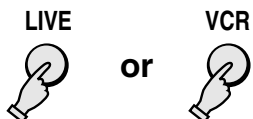

Canceling the Security Lock

To cancel the security lock, press the same (LIVE or VCR) button again for about 3 seconds. A buzzer will be heard and the mode will be unlocked.

SETTINGS BACKUP FUNCTION

This unit is equipped with a backup battery (lithium battery) to maintain the clock settings. When the unit is used under normal conditions, the backup battery is recharged. The battery is fully recharged after a minimum of about 30 hours, and will maintain the clock settings for up to 30 days.

NOTE: The settings may not be maintained properly if the backup battery has been recharged for less than 30 hours when the power goes off.

Battery Life

If the power is turned off for about one hour or more, when the power is restored, the (CLOCK SET) menu is displayed so the clock settings can be checked.

If the clock settings are reset to: 01-01-2000 SAT 00:00:00, that may indicate that the battery is dead and must be replaced.

Replacing the Battery

To replace the battery, please consult your dealer. After the battery has been replaced, press the **ALL RESET** button, then in the (CLOCK SET) menu set the date and time (see page 17).

RESET FUNCTION

The menus can be reset or cleared.

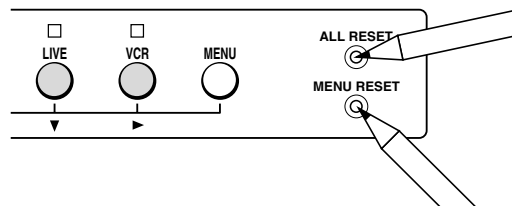

Using the MENU RESET Button

A: While a menu is displayed, press the **MENU RESET** button to reset all the values of the displayed menu to the default values.

B: If no menu is displayed, press the **MENU RESET** button to reset the time to the nearest hour.

NOTE: For example, between 10:30:00 and 11:29:59 the clock will be reset to 11:00:00.

Using the ALL RESET button

Press this button to reset the following:

- Reset the time and date in the (CLOCK SET) menu to the default setting.
- The display will return to the default quad screen display mode.

NOTE: If the unit does not function properly, press the **ALL RESET** button. Please note that all the settings mentioned above will be reset.

LIVE PICTURE MODE

(VIDEO OUT QUADFULL)

Operations with the monitor connected to the VIDEO OUT QUADFULL terminal.

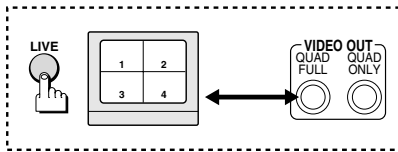

Press the LIVE button.

The live pictures from the cameras connected to the **CAMERA** terminals (1 – 4) on the unit back panel will be displayed.

Refer to the diagrams below for the buttons to press in order to select the desired operation mode.

LIVE PICTURE MODE OPERATIONS STEPS

Automatic switching between quad screen A and B

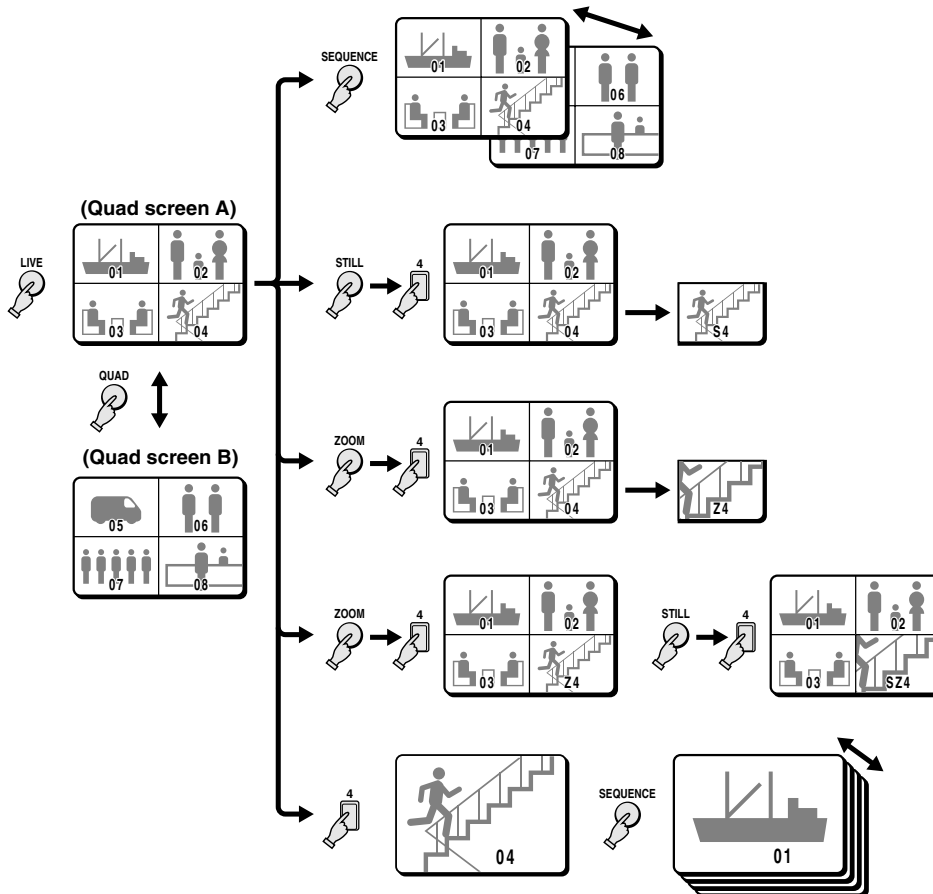

Selecting the quad screens A and B displayed cameras (☞ 21)

Settings entered in the (TIMER SET) menu.

Automatic sequential switching speed (delay) set for each camera (☞ 21, 22)

Settings entered in the (TIMER SET) and the (MONITOR SET) menus.

QUAD SCREEN OPERATIONS

(Live picture)

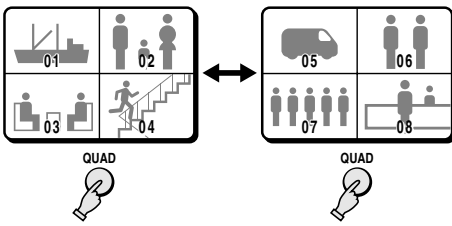

Press the QUAD button once.

The camera select indicators (1 – 4) light and quad screen A is displayed. Press the **QUAD** button one more time to switch to quad screen B.

NOTE: The quad screen (A or B) last selected is memorised and will be selected first when switching to quad screen mode again.

Sequential display of quad screen A and quad screen B at 1 second interval

Press the SEQUENCE button.

Quad screen A and quad screen B are displayed sequentially at 1 second interval. The camera select indicators (1 – 4, 5 – 8) light sequentially according to the displayed quad screen.

NOTE:

The sequential display speed (screen interval) is set to 1 second in the (MONITOR SET) menu. The sequence speed setting can be set as desired, refer to “**QUAD SEQ. TIMER**” on page 22.

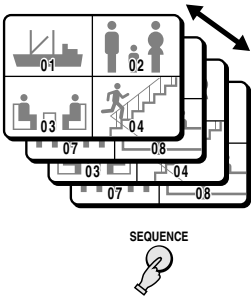

Selecting the quad screens A and B displayed cameras

TIMER SETTING: see page 21

Example 1:

CAMERA 1: ON	CAMERA 5: ON
CAMERA 2: ON	CAMERA 6: ON
CAMERA 3: ON	CAMERA 7: ON
CAMERA 4: ON	CAMERA 8: ON

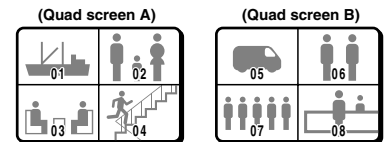

Example 2:

CAMERA 1: OFF	CAMERA 5: ON
CAMERA 2: OFF	CAMERA 6: ON
CAMERA 3: OFF	CAMERA 7: ON
CAMERA 4: OFF	CAMERA 8: ON

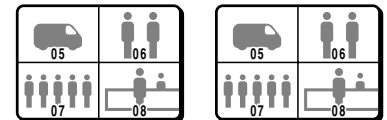

Example 3:

CAMERA 1: ON	CAMERA 5: OFF
CAMERA 2: ON	CAMERA 6: OFF
CAMERA 3: ON	CAMERA 7: OFF
CAMERA 4: ON	CAMERA 8: OFF

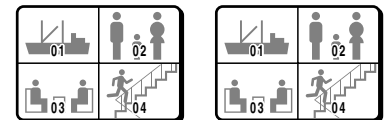

Example 4:

CAMERA 1: OFF	CAMERA 5: OFF
CAMERA 2: OFF	CAMERA 6: OFF
CAMERA 3: OFF	CAMERA 7: OFF
CAMERA 4: OFF	CAMERA 8: OFF

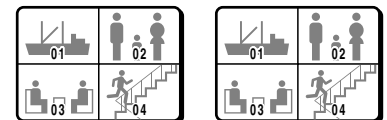

NOTE:

- When the timer is set, the quad screen will be selected according to the day/night settings.
- When the timer is not set, the day setting quad screen will be selected.

(TIMER SET)					
TIME	00:00		00:00		00:00
	SEQ.	QUAD	SEQ.	QUAD	
CAM1	T1	OFF	T1	ON	
CAM2	T1	OFF	T1	ON	
CAM3	T1	OFF	T1	ON	
CAM4	T1	OFF	T1	ON	
CAM5	T1	ON	T1	OFF	
CAM6	T1	ON	T1	OFF	
CAM7	T1	ON	T1	OFF	
CAM8	T1	ON	T1	OFF	

Camera number

Example 3:
Set the cameras to be ON/OFF during the night.

Example 2:
Set the cameras to be ON/OFF during the day.

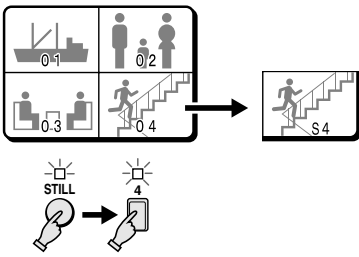

Example: To freeze the image from camera 4

- 1 Press the STILL button.**
The STILL indicator flashes and the still image display mode is selected.
 - 2 Press the camera select 4 button.**
The camera 4 indicator flashes, the image from camera 4 is frozen, and "S" flashes on-screen.
- To cancel the still image display mode**
Press the camera select 4 button one more time, then press the **STILL** button.

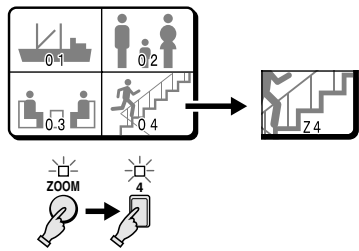

Example: To zoom in the image from camera 4

- 1 Press the ZOOM button.**
The ZOOM indicator flashes and the zoomed in image display mode is selected.
 - 2 Press the camera select 4 button.**
The camera 4 indicator flashes, the image from camera 4 is zoomed in, and "Z" flashes on-screen.
- To cancel the zoomed in image display mode**
Press the camera select 4 button one more time, then press the **ZOOM** button.

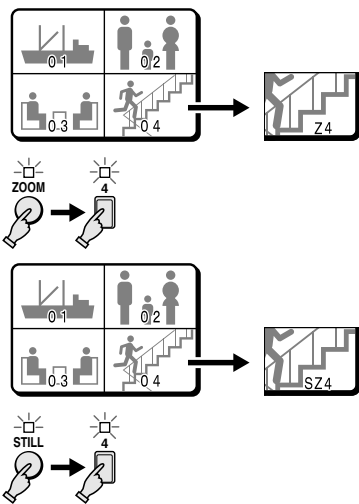

Example: To freeze the zoomed in image from camera 4

- 1 Press the ZOOM button.**
The ZOOM indicator flashes and the zoomed in image display mode is selected.
 - 2 Press the camera select 4 button.**
The camera 4 indicator flashes, the image from camera 4 is zoomed in, and "Z" flashes on-screen.
 - 3 Press the STILL button.**
The STILL indicator flashes and the ZOOM indicator lights.
 - 4 Press the camera select 4 button.**
The camera 4 indicator flashes, the zoomed in image from camera 4 is frozen, and "SZ" flashes on-screen.
- NOTE:** To use the zoom function again, first cancel the still image display mode.
- To cancel the still and zoomed in image display mode.**
Press the camera select 4 button, then press the **STILL** button.
Press the camera select 4 button, then press the **ZOOM** button.
- To cancel all the still image displays and zoomed in image displays**
Press the **STILL** button, then press the **ZOOM** button.

(The zoomed in area is set by the frame position.)

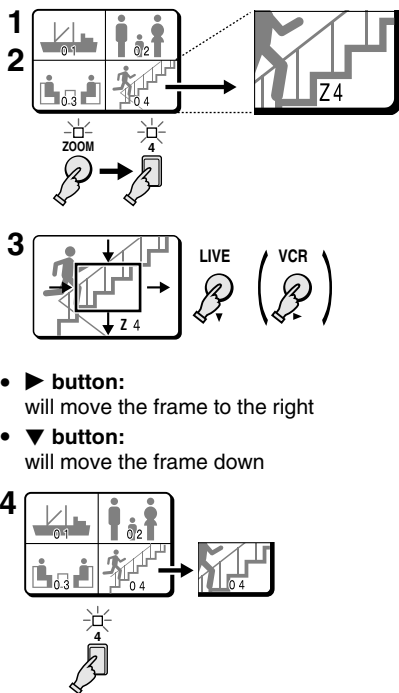

- **▶ button:**
will move the frame to the right
- **▼ button:**
will move the frame down

Example: To zoom in the image from camera 4 and set the zoom range

You can select the portion of the image to zoom in. The default zoomed in area is the centre of the image, but if a different zoom range is selected it will be memorized until changed or cancelled.

1 Press the ZOOM button.

The ZOOM indicator flashes and the zoomed in image display mode is selected.

2 Press the camera select 4 button for about 3 seconds.

In full screen mode, "Z" (flashing) and the zoom range frame are displayed.

NOTE: If during the zoom range setting, the displayed frame is not moved for about 10 seconds, the display mode will automatically return to quad screen display mode. To return to the setting mode, press the camera select 4 button again for about 3 seconds.

3 Press the ▶ (or ▼) button to move the zoom range frame to the desired area of the image.

4 Press the camera select 4 button.

The area selected by the zoom range frame is now zoomed in.

If necessary, follow the same procedure to set the zoom range for the other cameras.

NOTE: You can switch from zoomed in mode to normal (no zoom) mode by pressing the camera select 4 button repeatedly.

☞ To cancel the zoomed in image display mode.

Press the ZOOM button.

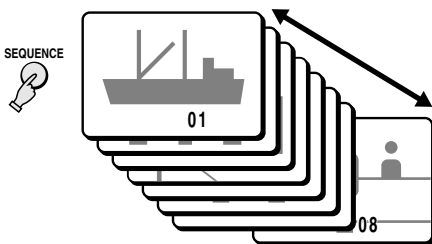
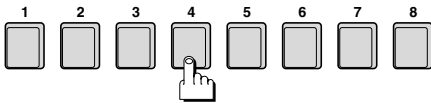

Press a camera select (1 – 8) button.

The camera select indicator lights and the live picture from the corresponding camera is displayed full screen.

NOTE: In full screen mode, still and zoomed in image display modes are not possible.

Sequential display of each camera pictures at 1 second interval

Press the SEQUENCE button.

The pictures from each camera are displayed sequentially at 1 second interval. The camera select indicators (1 – 8) light sequentially according to the displayed camera.

NOTE:

- The sequential display speed (image interval) is set to T1 or T2 in the (MONITOR SET) menu. The default setting for T1 and T2 is 1 second (see page 22).
- The sequential display speed (image interval) T1 or T2 can be set for each camera in the (TIMER SET) menu.

Camera number

(TIMER SET)				
TIME	07:30		19:30	
	SEQ.	QUAD	SEQ.	QUAD
CAM1	T1	ON	T1	OFF
CAM2	T2	OFF	T1	ON
CAM3	T1	ON	T1	OFF
CAM4	T2	OFF	T1	ON
CAM5	T1	ON	T2	OFF
CAM6	T2	OFF	T2	ON
CAM7	T1	ON	T2	OFF
CAM8	T2	OFF	T2	ON

Example 1

Example 2

(DISPLAY SET)		
LIVE	CLOCK	OFF
	TITLE	ON
POSITION SET+PRESS NEXT		
(MONITOR SET)		
FULL SEQ. TIMER		
	T1	02 S
	T2	05 S
QUAD SEQ. TIMER		01 S
QUADONLY+QUADFULL		N

Set the sequential display speed (see page 22)

Setting the sequential display speed for each camera

- 1 In the (TIMER SET) menu, set the item "SEQ." to "T1" or "T2".
- 2 In the (MONITOR SET) menu, set the desired speed for items "FULL SEQ. TIMER T1" and "FULL SEQ. TIMER T2".

Example 1: Sequential display speed for daytime (7:30 AM ~ 7:30 PM)

- Camera 1: T1 (2 sec.)
- Camera 2: T2 (5 sec.)
- Camera 3: T1 (2 sec.)
- Camera 4: T2 (5 sec.)
- Camera 5: T1 (2 sec.)
- Camera 6: T2 (5 sec.)
- Camera 7: T1 (2 sec.)
- Camera 8: T2 (5 sec.)

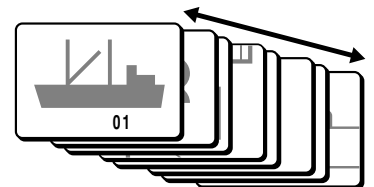

Example 2: Sequential display speed for nighttime (7:30 PM ~ 7:30 AM)

- Camera 1: T1 (2 sec.)
- Camera 2: T1 (2 sec.)
- Camera 3: T1 (2 sec.)
- Camera 4: T1 (2 sec.)
- Camera 5: T2 (5 sec.)
- Camera 6: T2 (5 sec.)
- Camera 7: T2 (5 sec.)
- Camera 8: T2 (5 sec.)

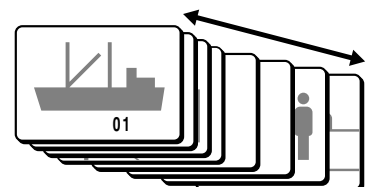

VCR PLAYBACK MODE

(VIDEO OUT QUADFULL)

Operations with the monitor connected to the VIDEO OUT QUADFULL terminal.

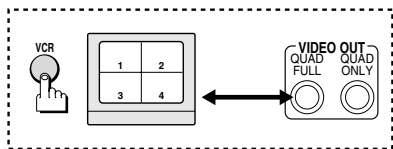

Press the VCR button.

The VCR playback mode is selected. When a tape is played back, the recording of the live pictures will be displayed on the monitor.

Refer to the diagrams below for the buttons to press in order to select the desired operation mode.

If live pictures are recorded in full screen mode, playback will only be available in full screen mode. Quad screen playback of such a recording is not possible.

QUAD SCREEN OPERATIONS

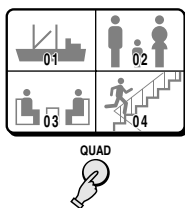

Press the QUAD button.

The camera select indicators (1 – 4) light and quad screen A is displayed.

NOTE: It is not possible to switch to quad screen B of the recorded pictures.

FULL SCREEN OPERATIONS

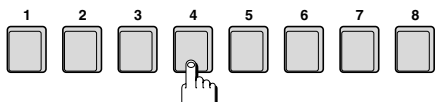

Press a camera select (1 – 4) button.

The recorded pictures from the selected camera will be displayed full screen.

NOTE:

- In full screen and quad screen modes, still and zoomed in image display modes are not possible.
- If the recording has been made using the quad screens (A and B) auto switching, and if, for example, camera select button 1 is pressed, the display will switch between the images from camera 1 and camera 5.

Full screen sequential display at 1 second interval

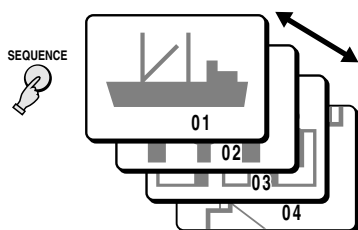

Press the SEQUENCE button.

The pictures are displayed sequentially at 1 second interval. The camera select indicators (1 – 4) light sequentially according to the displayed camera.

NOTE:

- The sequential display speed (image interval) is set in the (MONITOR SET) menu. To change the sequence speed setting, refer to “**FULL SEQ. TIMER**” on page 22.
- The sequential display speed (image interval) “**FULL SEQ. TIMER T1**” or “**T2**” can be set for each camera in the (TIMER SET) menu.

MENU SETTING MODE

MENUS DISPLAYS

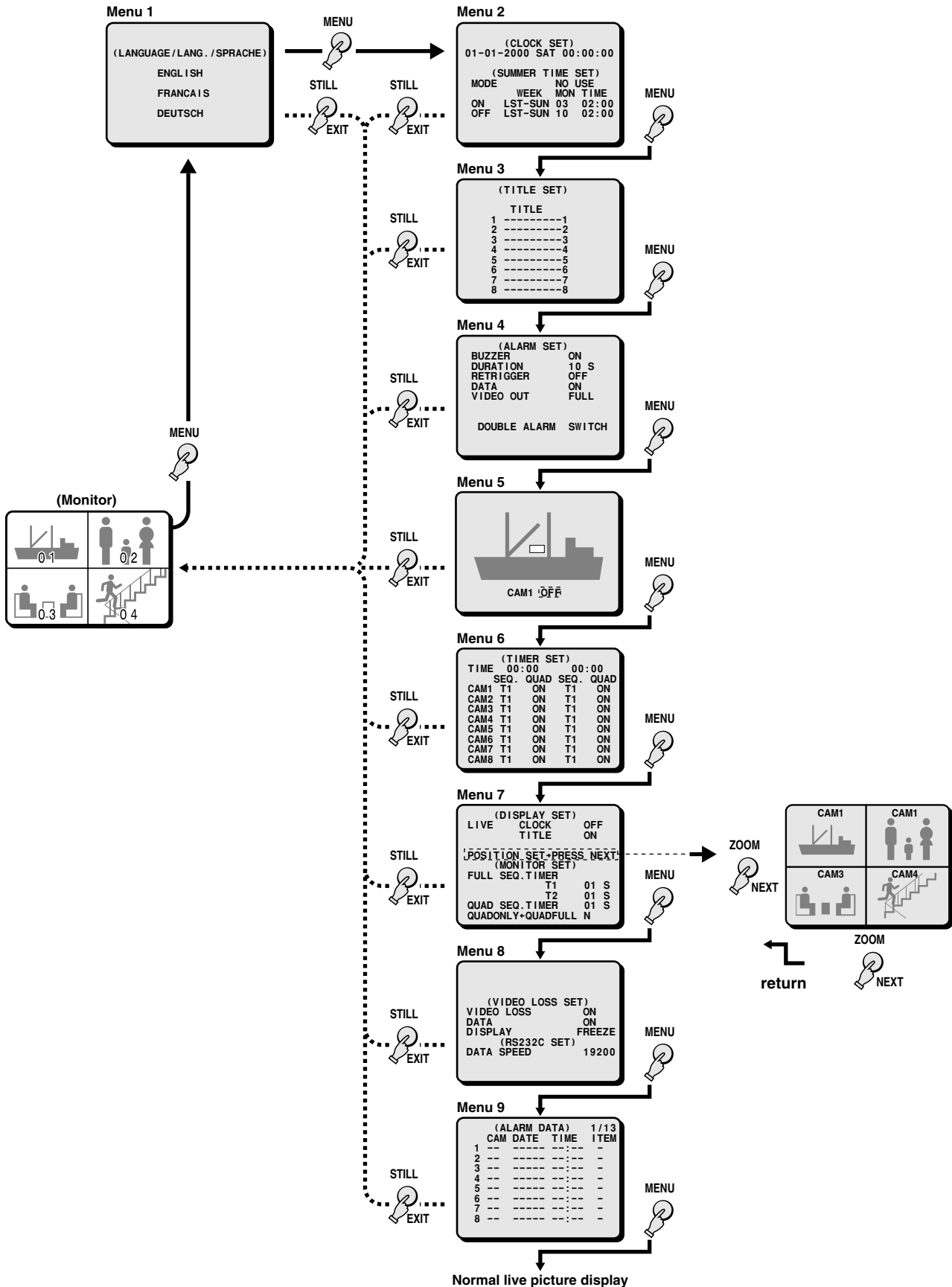

To display the menus, press the MENU button.



(LANGUAGE/LANG./SPRACHE)

The default menu language is English. The available language settings are English, French and German.

Setting the language

- 1** Press the MENU button once to display the (LANGUAGE/LANG./SPRACHE) menu.
- 2** Press the ▼ button to highlight the desired language.
- 3**  Press the MENU button to go to the next menu, or  Press the EXIT button to exit the menu display, the selected language is set.
All the on-screen menus and settings will be displayed in the selected language.

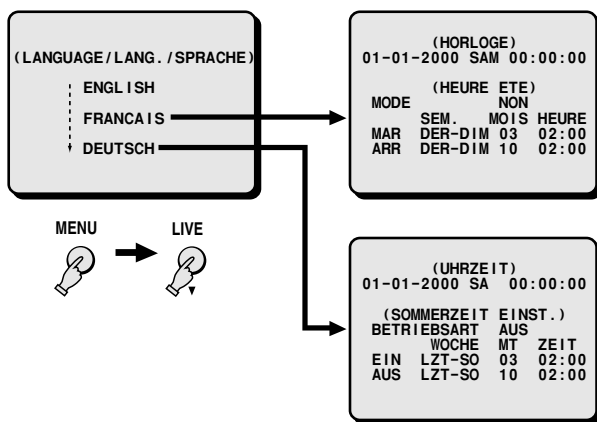

(CLOCK SET)

The default setting is as indicated below. The clock will start after the actual time and date are set and the operations under (SUMMER TIME SET) are completed.

Default clock settings: 01:01:2000 SAT 00:00:00
(January 1, 2000 at 00:00)

1 Press the MENU button twice to display the (CLOCK SET) menu.

2 Example: Setting the clock to October 15, 1999 at 3:20 PM

- ① Press the + (or -) button to set the day (15), then press the ► button.
- ② Press the + (or -) button to set the month (10), then press the ► button.
- ③ Press the + (or -) button to set the year (1999), then press the ► button.
- ④ Press the + (or -) button to set the hours (15), then press the ► button.
- ⑤ Press the + (or -) button to set the minutes (20), then press the ► button.

NOTE: The day of the week (SAT) will be automatically set according to the date entered.

3 Press the ▼ button to go to the (SUMMER TIME SET) menu.

Press the MENU button to go to the next menu screen, or

Press the EXIT button to exit the menu display.

2-①

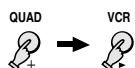
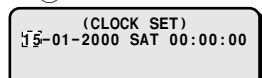

2-②~⑤

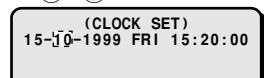

NOTE: To set the display mode for the clock, refer to "DISPLAY SET (CLOCK, TITLE)" on page 22.

(SUMMER TIME SET)

The default summer time function setting is "NO USE", so the summer adjustment will not be made.

If the unit will be used in an area where there is a summer time change, set it to "USE", then if necessary, set when the summer time is changed.

The default settings are:

Summer time from the last Sunday of March, at 2:00 AM (LST-SUN 03 02:00) to last Sunday of October, at 2:00 AM (LST-SUN 10 02:00).

TO MAKE CHANGES TO THE SETTINGS

1 Press the ▼ button to highlight the NO USE setting, then press the + (or -) button to select "USE", and press the ▼ button one more time.

2 Example: Setting the summer time from the second Tuesday of May at 3:00 AM, to the fourth Tuesday of September at 3:00 AM.

① Press the + (or -) button to set the WEEK (2ND), then press the ► button.

Setting: 1ST, 2ND, 3RD, 4TH or LST (first, second, third, fourth or last)

② Press the + (or -) button to set the WEEK (TUE), then press the ► button.

Setting: SUN, MON, TUE, WED, THU, FRI, SAT or SUN

③ Press the + (or -) button to set the MON (05), then press the ► button.

Setting: 1, 2, 3, 4 11, 12
(for January, February, March December)

④ Press the + (or -) button to set the TIME (03), then press the ► button.

- Following the same procedure as above, set when the time is changed back from daylight saving time to standard time (the OFF settings).

3 Press the MENU button to go to the next menu screen, or

Press the EXIT button to exit the menu display.

1

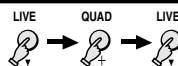
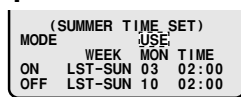

2-②

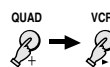
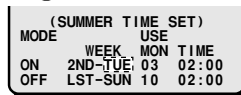

2-④

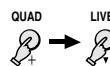

2-①

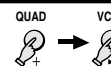
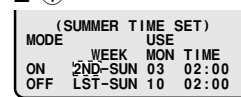

2-③

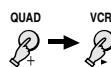

When a picture from a camera is displayed on-screen the camera number (1 to 8) is displayed at the bottom of the image. You can enter a camera title, such as the camera location (up to 10 characters), that will be displayed instead of the camera number.

(TITLE SET)

- 1** Press the MENU button 3 times to display the (TITLE SET) menu.
- 2** Example: To set the title "GATE-1F" for the camera 1 and "HALL-2F" for camera 2.
 - ① Press the + (or -) button to set the first character "G", then press the ► button.
By pressing the + (or -) button repeatedly, the characters are selected as follows:
 - **Letters:** A, B, C,...X, Y, Z
 - **Numbers:** 0, 1,...8, 9
 - **Symbols:** - : . / * _
 - ② Following the same procedure, enter the rest of the title "ATE-1F".
 - ③ Press the ▼ button to set the cursor at the first character location for camera 2. Press the + (or -) button to set first character "H", then press the ► button.
 - ④ Following the same procedure, enter the rest of the title "ALL-2F".
- 3** Press the MENU button to go to the next menu screen, or Press the EXIT button to exit the menu display.

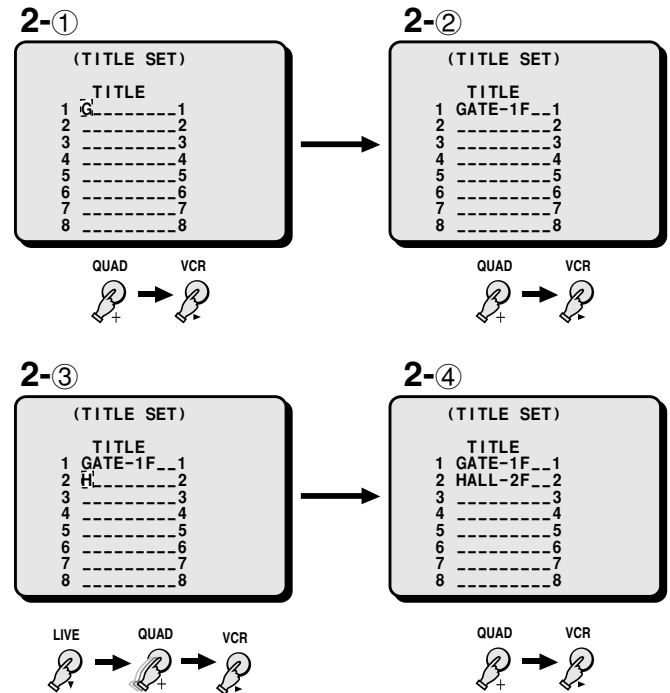

NOTE: To set the display mode for the title, refer to "DISPLAY SET (CLOCK, TITLE)" on page 22.

When an alarm trigger is received from sensors such as a door bell, movement sensor, etc. you can set the display mode and the recording mode for the pictures from the concerned camera.

(ALARM SET)

Changing the Settings

- 1 Press the MENU button 4 times to display the (ALARM SET) menu.
- 2 Press the ▼ button to highlight the setting to modify.
- 3 Using the + (or -) button, select the desired setting, then press the ▼ button.
 - Repeat step 3, until all the settings are as desired.
- 4 Press the MENU button to go to the next menu screen, or Press the EXIT button to exit the menu display.

1, 2

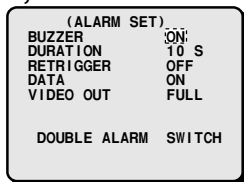

3

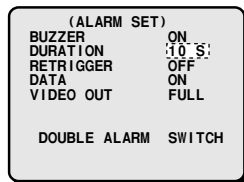

ALARM SET menu

BUZZER

- ON:** A buzzer will be heard when an alarm trigger is received. (Default setting)
- OFF:** The buzzer will not be heard.

DURATION

- The alarm duration can be set to:** 1, 2, 3, 4, 5, 10 (Default setting), 30 seconds, CC, NC
- CC:** The alarm will go on for as long as the alarm signal is received (minimum 1 second).
- NC:** The alarm will continue until canceled.

RETRIGGER

- To set if an alarm is received while the unit is already in alarm mode.
- OFF:** The unit will not receive another alarm, while one is already being received. (Default setting)
- ON:** During alarm mode, other alarm triggers will be received and the alarm duration will be extended.

DATA

- The camera number, date, time, type of the alarm can be recorded. (To view the recorded alarm data, refer to "ALARM DATA DISPLAY" on page 26.)
- ON:** The alarm data is recorded. (Default setting)
- OFF:** The alarm data is not recorded.

VIDEO OUT (A)

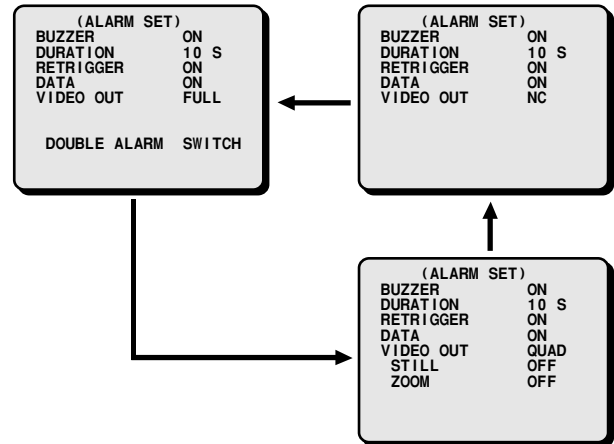

FULL: If an alarm trigger is received while in quad screen, the picture from the camera corresponding to the alarm input will be displayed full screen. (Default setting)

DOUBLE ALARM

This item is only displayed and can only be set if "VIDEO OUT" above is set to "FULL".

SWITCH: The picture from each concerned camera will be displayed sequentially at 1 second interval. (Default setting)

FIRST: The picture from the first alarm received only is displayed.

LAST: The picture from the last alarm received is displayed.

VIDEO OUT (B)

QUAD: If an alarm trigger is received while in full screen, the display mode will switch to quad screen.

STILL

- ON:** The image from the camera corresponding to the alarm trigger will be frozen.
- OFF:** The image will not be frozen. (Default setting)

ZOOM

- ON:** The image from the camera corresponding to the alarm trigger will be zoomed in.
- OFF:** The image will not be zoomed in. (Default setting)

VIDEO OUT (C)

NC: The display mode will remain unchanged when an alarm trigger is received.

You can set an area of the image on the screen to be used as a video sensor (□). The video sensor detects movement in the selected area of the image and sends an alarm trigger that will initiate priority recording of the images from the concerned camera.

(VIDEO SENSOR SET)

SETTING THE VIDEO SENSOR POSITION AND SENSITIVITY LEVEL

1 Press the MENU button 5 times to display the video sensor setting screen.

The video sensor is displayed on the live picture from camera 1.

Press the NEXT button repeatedly to select the video sensor setting screen for the other cameras.

2 Using the ▼ (or ►) button move the video sensor down (or right) to the desired alarm sensor area position.

3 Press the + (or -) button to raise (or lower) the sensor sensitivity level.

The available sensitivity levels are:

OFF (not used), 01, 02, 03, 04, 05, 06, 07, 08, 09, 10 (10 being the least sensitive)

4 Press the MENU button to go to the next menu screen, or

Press the EXIT button to exit the menu display.

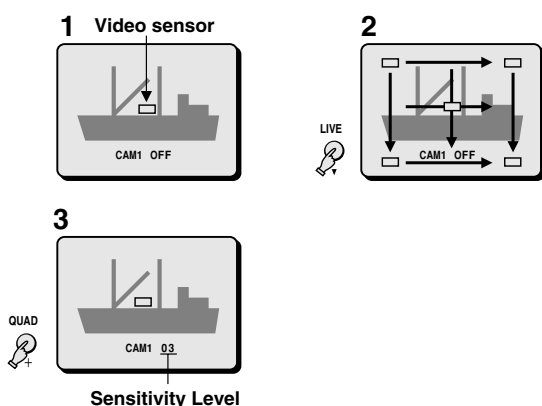

VIDEO SENSOR ALARMS

Example: If an alarm trigger is received for camera 4 (in quad screen)

1 The buzzer is heard and the camera 4 indicator light. The alarm output changes from HI (5V) to LOW (0V).

2 The image from camera 4 and the camera number (04) will be displayed, SA (Video Sensor Alarm) will flash at the left of the camera number.



Video sensor alarm Camera number

Example of display when there is an alarm trigger.

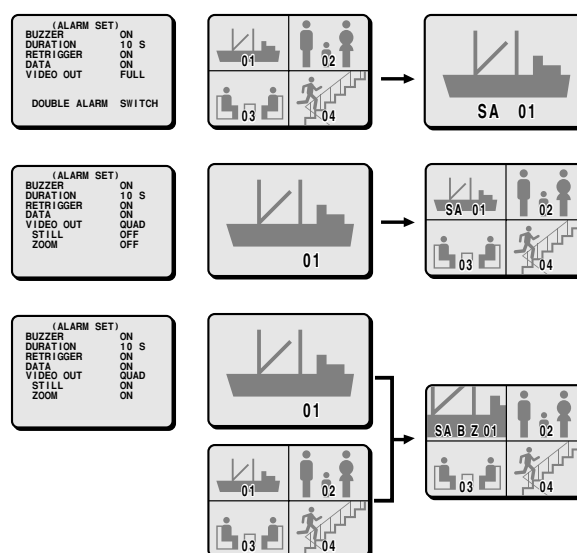

NOTE: The display mode (quad or full screen) selected for the alarm operation is set by the item "VIDEO OUT" in the (ALARM SET) menu (see page 19).

Resetting the Alarm

- For an alarm in full screen display mode, press the corresponding camera select button twice.
- For an alarm in quad screen display mode, press the corresponding camera select button to switch to full screen display mode then press the corresponding camera select button one more time.

NOTE:

- During normal monitoring operations, the camera select indicator lights according to the displayed camera. If there is an alarm trigger for another camera, the indicator will flash.
- When in quad screen A, even if a video sensor alarm is triggered at a quad screen B camera, the display will not switch to quad screen B.

The timer can be set to record during the daytime and/or nighttime. According to the timer settings, each camera picture full screen display switching speed can be set, and the cameras to be displayed in the quad screens can be selected.

(TIMER SET)

- 1** Press the MENU button 6 times to display the (TIMER SET) menu.
- 2** Set the daytime period start and end times.

Example: To set the daytime period from 7:30 AM to 7:30 PM (the nighttime will then be from 7:30 PM to 7:30 AM).

 - ① Using the + (or -) button, select the starting hour (7) (the first part of the first setting of the TIME line).
 - ② Press the ► button, then using the + (or -) button select the starting minutes (30) (the second part of the first setting of the TIME line).
 - ③ Press the ► button, then using the + (or -) button select the end hour (19) (the first part of the second setting of the TIME line).
 - ④ Press the ► button, then using the + (or -) button select the end minutes (30) (the second part of the second setting of the TIME line).
- 3** Set the timer operations for each (daytime/nighttime) period.

(Daytime)

- ① Press the ▼ button, then using the + (or -) button select the switching speed "T1" or "T2" in the first SEQ. column for camera 1. (This sets the duration the image from camera 1 is displayed, when in full screen mode, during the daytime period.)
- ② Press the ► button, then using the + (or -) button select "ON" or "OFF" in the first QUAD column for camera 1. (This determines if the image from that camera is displayed (ON) or not (OFF), when in quad screen mode, during the daytime.)

(Nighttime)

- ③ Press the ► button, then using the + (or -) button select the switching speed "T1" or "T2" in the second SEQ. column for camera 1. (This sets the duration the image from camera 1 is displayed, when in full screen mode, during the nighttime period.)
- ④ Press the ► button, then using the + (or -) button select "ON" or "OFF" in the second QUAD column for camera 1. (This determines if the image from that camera is displayed (ON) or not (OFF), when in quad screen mode, during the nighttime.)

NOTE: The settings for the sequential display speeds T1 and T2 are entered in the (MONITOR SET) menu.

- 4** Press the MENU button to go to the next menu screen or,
 Press the EXIT button to exit the menu display.

Daytime start time Daytime end time

(TIMER SET)					
TIME	00:00	00:00			
	SEQ.	QUAD	SEQ.	QUAD	
CAM1	T1	ON	T1	ON	
CAM2	T1	ON	T1	ON	
CAM3	T1	ON	T1	ON	
CAM4	T1	ON	T1	ON	
CAM5	T1	ON	T1	ON	
CAM6	T1	ON	T1	ON	
CAM7	T1	ON	T1	ON	
CAM8	T1	ON	T1	ON	

Daytime setting area

Nighttime setting area

2-①

(TIMER SET)					
TIME	07:00	00:00			
	SEQ.	QUAD	SEQ.	QUAD	
CAM1	T1	ON	T1	ON	
CAM2	T1	ON	T1	ON	
CAM3	T1	ON	T1	ON	
CAM4	T1	ON	T1	ON	
CAM5	T1	ON	T1	ON	
CAM6	T1	ON	T1	ON	
CAM7	T1	ON	T1	ON	
CAM8	T1	ON	T1	ON	



2-②

(TIMER SET)					
TIME	07:30	00:00			
	SEQ.	QUAD	SEQ.	QUAD	
CAM1	T1	ON	T1	ON	
CAM2	T1	ON	T1	ON	
CAM3	T1	ON	T1	ON	
CAM4	T1	ON	T1	ON	
CAM5	T1	ON	T1	ON	
CAM6	T1	ON	T1	ON	
CAM7	T1	ON	T1	ON	
CAM8	T1	ON	T1	ON	

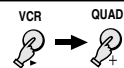

2-③

(TIMER SET)					
TIME	07:30	19:00			
	SEQ.	QUAD	SEQ.	QUAD	
CAM1	T1	ON	T1	ON	
CAM2	T1	ON	T1	ON	
CAM3	T1	ON	T1	ON	
CAM4	T1	ON	T1	ON	
CAM5	T1	ON	T1	ON	
CAM6	T1	ON	T1	ON	
CAM7	T1	ON	T1	ON	
CAM8	T1	ON	T1	ON	

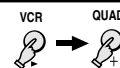

2-④

(TIMER SET)					
TIME	07:30	19:30			
	SEQ.	QUAD	SEQ.	QUAD	
CAM1	T1	ON	T1	ON	
CAM2	T1	ON	T1	ON	
CAM3	T1	ON	T1	ON	
CAM4	T1	ON	T1	ON	
CAM5	T1	ON	T1	ON	
CAM6	T1	ON	T1	ON	
CAM7	T1	ON	T1	ON	
CAM8	T1	ON	T1	ON	



3-①

(TIMER SET)					
TIME	07:30	19:30			
	SEQ.	QUAD	SEQ.	QUAD	
CAM1	T1	ON	T1	ON	
CAM2	T1	ON	T1	ON	
CAM3	T1	ON	T1	ON	
CAM4	T1	ON	T1	ON	
CAM5	T1	ON	T1	ON	
CAM6	T1	ON	T1	ON	
CAM7	T1	ON	T1	ON	
CAM8	T1	ON	T1	ON	



3-②

(TIMER SET)					
TIME	07:30	19:30			
	SEQ.	QUAD	SEQ.	QUAD	
CAM1	T1	ON	T1	ON	
CAM2	T1	ON	T1	ON	
CAM3	T1	ON	T1	ON	
CAM4	T1	ON	T1	ON	
CAM5	T1	ON	T1	ON	
CAM6	T1	ON	T1	ON	
CAM7	T1	ON	T1	ON	
CAM8	T1	ON	T1	ON	



3-③

(TIMER SET)					
TIME	07:30	19:30			
	SEQ.	QUAD	SEQ.	QUAD	
CAM1	T1	ON	T1	ON	
CAM2	T1	ON	T1	ON	
CAM3	T1	ON	T1	ON	
CAM4	T1	ON	T1	ON	
CAM5	T1	ON	T1	ON	
CAM6	T1	ON	T1	ON	
CAM7	T1	ON	T1	ON	
CAM8	T1	ON	T1	ON	

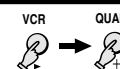

3-④

(TIMER SET)					
TIME	07:30	19:30			
	SEQ.	QUAD	SEQ.	QUAD	
CAM1	T1	ON	T1	ON	
CAM2	T1	ON	T1	ON	
CAM3	T1	ON	T1	ON	
CAM4	T1	ON	T1	ON	
CAM5	T1	ON	T1	ON	
CAM6	T1	ON	T1	ON	
CAM7	T1	ON	T1	ON	
CAM8	T1	ON	T1	ON	

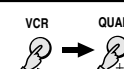

CLOCK, TITLE DISPLAY AND MONITOR SETTINGS

(DISPLAY SET)

The clock and the camera title settings entered in the menus (CLOCK SET) and (TITLE SET) can be displayed on-screen.

SETTING THE CAMERA TITLE AND THE CLOCK DISPLAY POSITION (POSITION SET)

- 1 Press the MENU button 7 times to display the (DISPLAY SET) menu.
- 2 Using the + (or -) button, select the desired setting, then press the ▼ button.
 - Following this procedure, select the settings for LIVE CLOCK and TITLE.
- 3 From the (DISPLAY SET) menu, press the NEXT button. The quad screen A display is selected.
- 4 Using the + (or -) button, set the camera title display position. (Select among the 3 positions.)
- 5 Using the ▼ button, set the clock display position.
- 6 Press the NEXT button. The display will return to the (DISPLAY SET) menu.
 - ☞ Press the MENU button to go to the next menu screen, or
 - ☞ Press the EXIT button to exit the menu display.

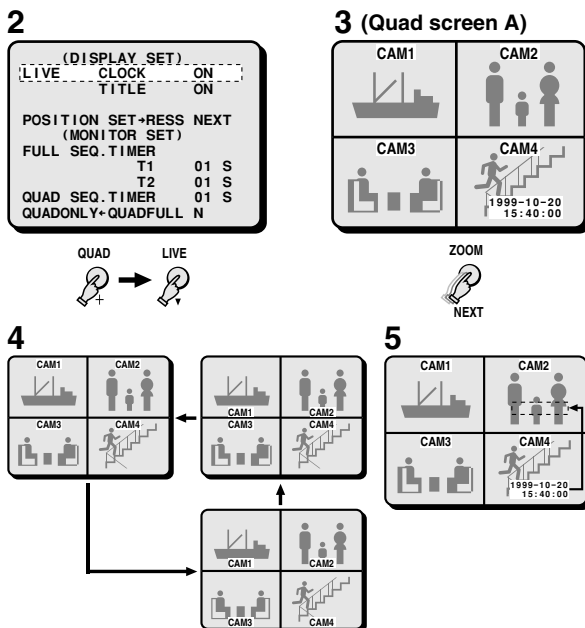

DISPLAY SET menu

LIVE CLOCK

- ON: The clock is displayed during live picture mode.
- OFF: The clock is not displayed during live picture mode. (Default setting)

LIVE TITLE

- ON: The camera title is displayed during live picture mode. (Default setting)
- OFF: The camera title is not displayed during live picture mode.

(MONITOR SET)

You can set the sequential display speed T1 and T2, and the quad screen A and B switching speed. Switching the display mode on the monitor connected to the VIDEO OUT (QUAD ONLY) terminal from quad screen to full screen display is also possible in this menu.

These FULL and QUAD SEQ.TIMER settings must only be done when not using a SW IN signal.

When using a SW IN signal, please refer to "Setting up the VCR signal output (SW IN) automatic switching speed" on page 26.

MONITOR SET menu

Press the ▼ button to select the desired item, then using the + (or -) button, select the desired setting.

FULL SEQ. TIMER T1

Set the desired speed at which the full screen image will be switched. The sequential display speed T1 (or T2) setting is applied in the (TIMER SET) menu (see page 21).

The automatic switching speed is entered in seconds of interval.

01 (default), 02, 03, 04, 05, 10, 20, 30

FULL SEQ. TIMER T2

Set the desired speed at which the full screen image will be switched. The sequential display speed T2 (or T1) setting is applied to each camera in the (TIMER SET) menu (see page 21).

The automatic switching speed is entered in seconds of interval.

01 (default), 02, 03, 04, 05, 10, 20, 30, OFF

OFF: The camera this setting is applied to will be skipped.

QUAD SEQ. TIMER

Set the desired speed at which the display will switch between quad screen A and B.

The automatic switching speed is entered in seconds of interval.

01 (default), 02, 03, 04, 05, 10, 20, 30











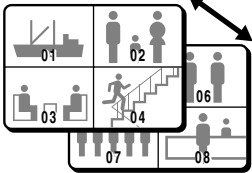
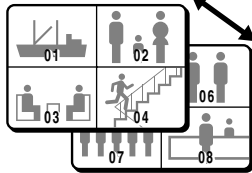

QUADONLY ← QUADFULL

Y: A quad screen and full screen display will be output to the monitor connected to the QUADONLY terminal.

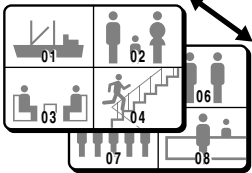
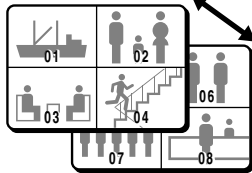

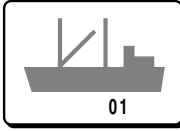
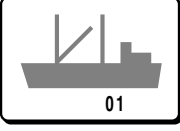
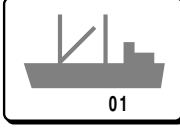

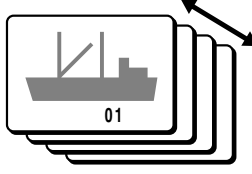

N (Default): A quad screen only will be output to the monitor connected to the QUADONLY terminal.

NOTE: For more information on the monitor displays, please refer to Table 1 and 2 (see pages 23, 24).

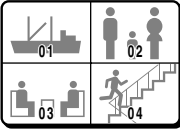
■ Display when no switching signal input is present (Table 1)

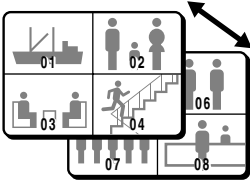
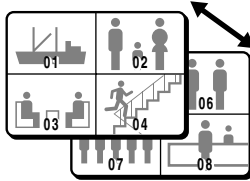
(MONITOR SET) menu		QUADONLY ← QUADFULL setting	N (normal setting)	Y
<p>QUAD</p> 	<p>Quad screen A or B display</p>	<p>Image output at the VIDEO OUT terminal</p> <p>QUAD ONLY</p> <ul style="list-style-type: none"> Either setting (Y or N) Quad screen A or B (manual switching possible) 		
	<p>Quad screen A or B automatic switching display</p>	<p>QUAD ONLY</p> <ul style="list-style-type: none"> Either setting (Y or N) Automatic switching of the display will depend on the quad screen A/B settings entered in the (TIMER SET) menu. 		
	<p>SEQUENCE</p> 	<p>QUAD FULL</p> <ul style="list-style-type: none"> Either setting (Y or N) Automatic switching of the display will depend on the quad screen A/B settings entered in the (TIMER SET) menu. 		
		<p>QUAD ONLY</p> <ul style="list-style-type: none"> N setting: Quad screen A or B Y setting: Full screen display of a live picture (manual switching possible) 		
<p>1</p>  <p>(1 - 8)</p>	<p>Full screen display</p>	<p>QUAD FULL</p> <ul style="list-style-type: none"> Either setting (Y or N) Full screen display of a live picture (manual switching possible) 		
	<p>Automatic switching display</p>	<p>QUAD ONLY</p> <ul style="list-style-type: none"> N setting: Quad screen A or B Y setting: Full screen display of a live picture switched according to the setting entered in the menu 		
	<p>SEQUENCE</p> 	<p>QUAD FULL</p> <ul style="list-style-type: none"> Either setting (Y or N) Full screen display of a live picture switched automatically according to the setting entered in the menu 		

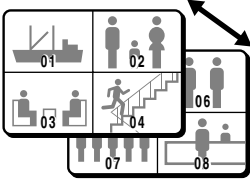
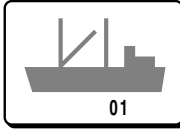
■ Display when a switching signal input is present (Table 2)

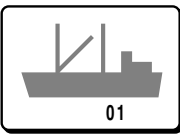
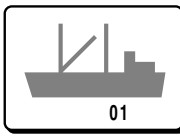
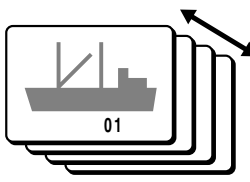
(MONITOR SET) menu		QUADONLY ← QUADFULL setting	N (normal setting)	Y
<p>QUAD</p> 	<p>Quad screen A or B display</p>	<p>Image output at the VIDEO OUT terminal</p> <p>QUAD ONLY</p> <ul style="list-style-type: none"> Either setting (Y or N) Quad screen A or B (manual switching possible) 		
	<p>Quad screen A or B automatic switching display</p> <p>SEQUENCE</p> 	<p>QUAD ONLY</p> <ul style="list-style-type: none"> Either setting (Y or N) Automatic switching of quad screen A/B according to the switching signal input at the SW terminal. The minimum switching speed delay will be 1 second. 		
<p>Full screen display</p>	<p>QUAD FULL</p> <ul style="list-style-type: none"> Either setting (Y or N) Full screen display of a live picture (manual switching possible) 			
	<p>Automatic switching display</p> <p>SEQUENCE</p> 	<p>QUAD ONLY</p> <ul style="list-style-type: none"> N setting: Automatic switching of quad screen A/B according to the switching signal input at the SW terminal. The minimum switching speed delay will be 1 second. Y setting: Automatic switching of a full screen display of a live picture according to the switching signal input at the SW terminal 		
<p>1</p> <p>(1 - 8)</p>	<p>QUAD FULL</p> <ul style="list-style-type: none"> N setting: Full screen display of a live picture switched automatically according to the setting entered in the menu Y setting: Automatic switching of a full screen display of a live picture according to the switching signal input at the SW terminal. The minimum switching speed delay will be 1 second. 			

VIDEO LOSS SETTING AND COMPUTER CONTROL SETTING

Menu 8

(VIDEO LOSS SET)

When the live picture signal feed is interrupted, you can set the action taken, and if the video loss is recorded as alarm data. This function will only operate in quad screen display, to select it, set "VIDEO LOSS" to "ON".

■ Setting the Video Loss Mode

- 1 Press the **▼** button to highlight the setting to modify.
- 2 Using the **+** (or **-**) button, select the desired setting, then press the **▼** button.
Following this procedure, select the settings for **DATA** and **DISPLAY**.
- 3 Press the **▼** button to go to the next menu, or
 Press the **MENU** button to go to the next menu screen, or
 Press the **EXIT** button to exit the menu display.

1, 2

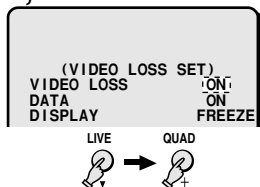

VIDEO LOSS SET menu

VIDEO LOSS

You can set the action to take when there is an interruption in the video signal feed.

ON: When there is video loss, the image just previous to the interruption is frozen on-screen or colour bars are displayed (see "DISPLAY" right) and "VIDEO LOSS" is displayed on-screen. (Default setting)

OFF: When there is video loss, "NO VIDEO" is displayed on-screen.

NOTE: If no camera is connected to one of the terminals, then "NO VIDEO" will be displayed on a grey screen. This will not trigger a video loss alarm.

DATA

You can set the data (date, time, etc) of the video losses to be recorded as alarm data. (To view the recorded data, refer to "ALARM DATA DISPLAY" on page 26.)

ON: The video losses data is recorded as alarm data. (Default setting)

OFF: The video losses data is not recorded.

DISPLAY

You can set the display mode when there is an interruption in the video signal feed.

FREEZE: When there is video loss, the image just previous to the interruption is frozen on-screen. (Default setting)

TEST: When there is video loss, colour bars are displayed on-screen.

NOTE: If the (VIDEO LOSS SET) menu, "DISPLAY" is set to "FREEZE", when there is a loss of the video signal, "VIDEO LOSS" and the image just previous to the interruption will be shown frozen on screen. To switch to a colour bars display, press the camera select button or **QUAD** button.

(RS232C SET)

Connect this unit to a computer, using a 9-pin D-SUB cable (sold separately), then set the maximum communication speed with the computer.

For detailed information, refer to "RS232C CONTROL" on page 28.

■ Changing the Setting

- 1 Press the **▼** button to highlight the setting to modify.
- 2 Using the **+** (or **-**) button, select the desired setting.
The available speeds are:
2400, 4800, 9600, 19200 (Default setting) bps
- 3 Press the **MENU** button to go to the next menu screen, or
 Press the **EXIT** button to exit the menu display.

1, 2

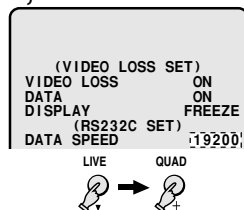



ALARM DATA DISPLAY

Menu 9

According to the settings entered in the (ALARM SET), (VIDEO SENSOR SET) and (VIDEO LOSS SET) menus, information about the alarms (alarm data) can be recorded. Up to 100 alarm data entries can be displayed on-screen (on up to 13 screens).

(ALARM DATA)

■ Displaying the Alarm Data

- 1 Press the MENU button 9 times to display the (ALARM DATA) menu.**
 - The first screen (1/13) of alarm data entries is displayed.
- 2 To display the next screen of alarm data entries, press the NEXT button.**
- 3**  **Press the EXIT button to exit the menu display, or**
 **Press the MENU button to return to the normal picture, then press the MENU button once more to display the menu display.**

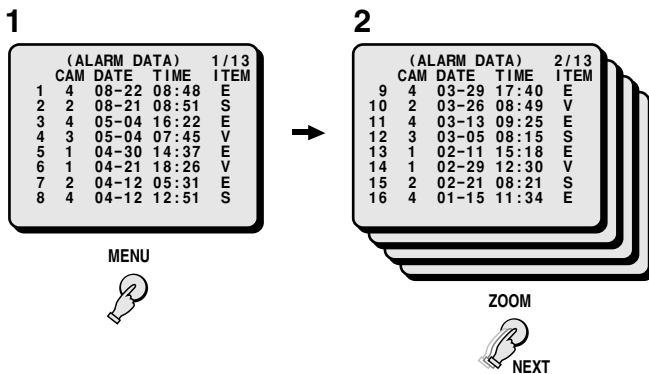

The codes in the ITEM column indicate the type of alarm data.

- E:** External alarm trigger (see page 27)
V: Video loss (see page 25, 27)
S: Video sensor alarms (see page 20, 27)

NOTE:

- When the number of recorded alarm data entries reaches 100, the oldest ones are erased as new ones are recorded.
- The alarm data screens are only displayed when alarm data entries are recorded.

SETTING UP THE VCR SIGNAL OUTPUT (SW IN) AUTOMATIC SWITCHING SPEED

- 1 Connect the unit SW IN terminal to the VCR SW OUT terminal (see page 5).**

- 2 Set the VCR recording speed.**

The settings entered for the SEQ. TIMER in menu 7 (MONITOR SET) will be ignored, and the full screen image and quad screen (A and B) switching speeds will be the speed set by the VCR.

NOTE:

- Even if the screens switching speed is set to a very quick timing, the minimum switching speed delay will be 1 second.
- Even when the switching timing is set using the SW IN terminal signal, the minimum switching speed delay will be 1 second (see page 24).

ALARMS OPERATIONS

There are three types of alarms; the alarms set by an external alarm trigger, the alarms set by a loss of the video signal and the alarms set by the video sensor.

EXTERNAL ALARMS

When external inputs such as a door bell, an interphone, etc., are connected to the **CONTROL** terminal (pins 1 – 8), they will send alarm triggers automatically. On the monitor screen, the alarm display will identify the camera corresponding to the alarm trigger.

Example: If an alarm trigger is received for camera 4 (in quad screen)

- 1 The buzzer is heard and the camera 4 indicator flashes.**
The alarm output changes from HI (5V) to LOW (0V).
- 2 The image from camera 4 and the camera number (04) will be displayed, EA (External Alarm) will flash at the left of the camera number.**

The action taken here will depend on the settings entered in the (ALARM SET) menu (see page 19).

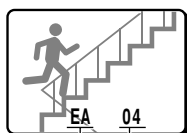

External alarm — Camera number

NOTE:

- When the alarm operation is over, the display will return to the mode preceding the alarm trigger.
- An alarm trigger can also be received at a terminal for which a camera is not connected to. In such a case, a grey screen will be displayed.
- The display mode (quad or full screen) selected for the alarm operation is set by the item “**VIDEO OUT**” in the (ALARM SET) menu.

Resetting the Alarm

- For an alarm in full screen display mode, press the corresponding camera select button twice.
- For an alarm in quad screen display mode, press the corresponding camera select button to switch to full screen display mode then press the corresponding camera select button one more time.

NOTE:

- The alarm display mode is selected according to the settings entered in the (**DISPLAY SET**) menu.
- During normal monitoring operations the camera select indicator lights according to the displayed camera. If there is an alarm trigger for another camera, the indicator will flash.

VIDEO LOSS ALARM

If there is an interruption of the video signal, the buzzer is heard, and the image just previous to the interruption is frozen on-screen or colour bars are displayed and “**VIDEO LOSS**” will flash on-screen.

The action taken will depend on the settings entered in the (VIDEO LOSS SET) menu (see page 25).



NOTE:

- If a video signal is not present from the beginning, then “**NO VIDEO**” will be displayed on a gray screen. This will not trigger a video loss alarm.
- The video loss alarm is recorded until the video signal is restored.
- In full screen display mode, video loss alarm is not possible.

Resetting the Alarm

- For an alarm in full screen display mode, press the corresponding camera select button.
- For an alarm in quad screen display mode, press the corresponding camera select button to switch to full screen display mode. Then, press the corresponding camera select button one more time.

NOTE:

- The alarm display mode is selected according to the settings entered in the (**ALARM SET**) menu.
- During normal monitoring operations the camera select indicator lights according to the displayed camera. If there is an alarm trigger for another camera, the indicator will flash.
- If the alarm is not reset, “**VIDEO LOSS**” will be displayed until normal live picture signals are restored.

VIDEO SENSOR ALARMS

The video sensor area is set in the (VIDEO SENSOR SET) menu. The brightness and contrast levels in the video sensor frame are used to trigger the alarm, and the alarm display (type of alarm and camera number) is shown on a live picture of the alarm trigger channel (see page 20).



Video sensor alarm — Camera number

RS232C CONTROL

CONNECTION

Connect a 9-pin D-SUB cable (sold separately) from the RS232C terminal on the rear panel to the computer serial connector.

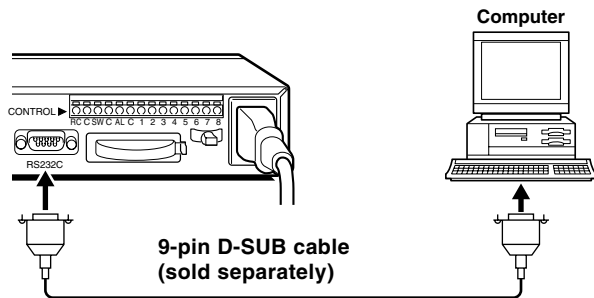

■ Setting the Data Transmission Speed

After the connection is made, set the data transmission speed in the (RS232C SET) menu (see page 25).

INTERFACE SPECIFICATIONS

For the RS232C terminal specifications, refer to page 4.

■ DATA FORMAT

Mode	Asynchronous
Character length	8 bits
Data transmission speed	2400, 4800, 9600, 19200 bps (set in the (RS232C SET) menu)
Parity check	None
Stop bit	One bit

■ TRANSMISSION PROTOCOL

The transmission is based on 1 byte units. After the computer has transmitted 1 byte, it will wait for an answer from this unit, then send the following byte of data.

The command ON (F6) is sent to start, and the command OFF (F7) is sent to finish. This unit will receive the commands, and will reply to each command by ACK (OA). (Refer to "COMMAND TABLE 4" on page 31.)

COMMANDS

■ COMMANDS AVAILABLE FROM THE COMPUTER

1-8 (90-97)

To select the picture from a camera to be displayed full screen.

QUAD (83)

To display a quad screen.

SEQUENCE (87)

In full screen mode, the display will be switched in order, automatically.

In quad screen mode, the display will switch between quad screen A and B automatically.

ZOOM (85)

To zoom a picture in quad screen.

STILL (86)

To freeze a picture in quad screen.

LIVE (80)

To select the live input mode.

VCR (81)

To select the VCR playback input mode.

MENU (74)

To display the menu or switch to the next menu.

+ (65), - (66)

To select settings for the menu items (ON/OFF, etc.)

→ (63), ↓ (64)

To change selection in the menus. (To move the cursor right, down.)

NEXT (75)

To switch to the sub-menus.

EXIT (76)

To go to the next menu, or to exit the menu mode.

MENU RESET (E1)

To reset all the values of the displayed menu to the default values.

CLOCK ADJUST (E0)

To reset the clock minutes and seconds setting to 00:00.

SECURITY LOCK ON (69)

To set the security lock.

SECURITY LOCK OFF (6A)

To cancel the security lock.

RS232C CONTROL

INFORMATION GATHERING COMMANDS

STATUS SENSE(D7)

When this command is sent from the computer, this unit will send a 5-byte response (see **Table 1**).

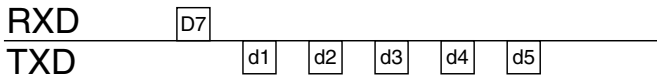

STATUS SENSE(D7) byte assignment (Table 1)

The third, fourth and fifth bytes are reserved.

First byte

Bit	Bit state information
7	LIVE/VCR indication 0: LIVE picture mode 1: VCR playback mode
6 5 4	3-bit indication of the display mode 000: Full screen 001: Quad screen 010: Menu display
3 2 1 0	4-bit indication of the channels and quad screen displayed (Full screen mode) 0000: Channel 1 0001: Channel 2 0010: Channel 3 0011: Channel 4 (Quad screen) 0000: Quad screen A (1, 2, 3, 4) 0001: Quad screen B (5, 6, 7, 8) (Menu display) 0000: Menu 1 (LANGUAGE/LANG./SPRACHE) 0001: Menu 2 (CLOCK SET) 0010: Menu 3 (TITLE SET) 0011: Menu 4 (ALARM SET) 0100: Menu 5 (VIDEO SENSOR SET) 0101: Menu 6 (TIMER SET) 0110: Menu 7 (DISPLAY SET) 0111: Menu 8 (VIDEO LOSS SET) 1111: Menu 9 (ALARM DATA)

Second byte

Bit	Bit state information
7	EXT/ALARM indication EXTERNAL ALARM is ON
6	VIDEO LOSS indication VIDEO LOSS is ON
5	SENSOR indication SENSOR is ON
4	Reserved 0
3 2 1 0	4-bit indication of the display mode 0000: Normal display mode 0001: Sequential display mode 0010: Zoomed in mode 0011: Still image mode 0100: Frozen zoomed in image 0101: Zoomed in still image 0110: Zoom range setting mode 0111: Zoomed in still image range setting mode

ALARM STATUS SENSE(D5)

The external, video loss and video sensor alarm states are indicated by a 6-byte response (see **Table 2**).

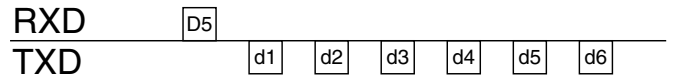

ALARM STATUS SENSE(D5) byte assignment (Table 2)

First byte

Bit	Bit state information
7	ALARM ON 8
6	ALARM ON 7
5	ALARM ON 6
4	ALARM ON 5
3	ALARM ON 4
2	ALARM ON 3
1	ALARM ON 2
0	ALARM ON 1

Second byte

Bit	Bit state information
7	0
6	0
5	0
4	0
3	0
2	0
1	0
0	0

Third byte

Bit	Bit state information
7	SENSOR 8
6	SENSOR 7
5	SENSOR 6
4	SENSOR 5
3	SENSOR 4
2	SENSOR 3
1	SENSOR 2
0	SENSOR 1

Fourth byte

Bit	Bit state information
7	0
6	0
5	0
4	0
3	0
2	0
1	0
0	0

Fifth byte

Bit	Bit state information
7	VIDEO LOSS 8
6	VIDEO LOSS 7
5	VIDEO LOSS 6
4	VIDEO LOSS 5
3	VIDEO LOSS 4
2	VIDEO LOSS 3
1	VIDEO LOSS 2
0	VIDEO LOSS 1

Sixth byte

Bit	Bit state information
7	0
6	0
5	0
4	0
3	0
2	0
1	0
0	0

RS232C CONTROL

■ COMMANDS AVAILABLE FROM THE QUAD COMPRESSOR

ACK(0A)

Response when this unit receives a command.

NAK(0B)

Response if this unit did not receive the command.

ALARM(BF)

When there is an alarm, this command is sent as header. Then, the alarm information is sent in a 1-byte transmission (see **Table 3**).

ALARM information (Table 3)

Bit		Bit state information
7	2-bit indication of the alarm type	01: External alarms
6		10: Video loss alarms 11: Sensor alarms
5	Reserved	0
4	Reserved	0
3	4-bit indication of the camera number	0011: CAMERA NO. 4
2		0010: CAMERA NO. 3
1		0001: CAMERA NO. 2
0		0000: CAMERA NO. 1

■ OTHER COMMANDS

ENTER(40)

When numeric commands are all sent, this command is used to enter the transmitted value.

CLEAR(56)

To erase multiple byte commands.

RS232C CONTROL

COMMAND TABLE (TABLE 4)

The commands available are indicated in the table.

If a function is not available on the unit, the command will not operate even if sent.

	0	1	2	3	4	5	6	7	8	9
0				0	ENTER				LIVE	FULL 1
1				1					VCR PB	FULL 2
2				2				(VERSION)	(MULTI)	FULL 3
3				3		(←)	→	(SHIFT)	QUAD	FULL 4
4				4		(↑)	↓	MENU	(PLUS)	FULL 5
5				5			+	NEXT	ZOOM	FULL 6
6				6		CLEAR	-	EXIT	STILL	FULL 7
7				7					SEQ.	FULL 8
8				8						
9				9				SECURITY LOCK ON		
A	ACK							SECURITY LOCK OFF		
B	NAK							(POWER ON/OFF)		
C								(SET ON)		
D								(SET OFF)		
E										
F										

	A	B	C	D	E	F
0					CLK. ADJ.	
1					MENU RESET	
2						
3						
4						
5				ALARM STATUS SENSE		
6						
7				STATUS SENSE		
8						
9						
A						
B						
C						
D						
E						
F		ALARM				

SPECIFICATIONS

Signal format	: Based on PAL colour signal standard (VQC-801P) Based on PAL B/W signal standard (VQM-801P)
Camera signal input synchronization	: Asynchronous
Camera input terminals (CAMERA)	: VS/VBS, 1.0 Vp-p/75 Ω , BNC connector x 8
VCR input terminal (VCR IN)	: Composite input, VS/VBS, 1.0 Vp-p/75 Ω , BNC connector x 1
VIDEO output terminal 1 (VIDEO OUT QUAD FULL)	: Composite output: Quad screen/Full screen VS/VBS, 1.0 Vp-p/75 Ω , BNC connector x 1
VIDEO output terminal 2 (VIDEO OUT QUAD ONLY)	: Composite output: Quad screen only VS/VBS, 1.0 Vp-p/75 Ω , BNC connector x 1
Control terminal (CONTROL)	: Push-type terminal
• Alarm input (1 – 8)	: No voltage, make-contact switch input x 8 (Low input)
• Remote input (RC)	: 2-wire type with resistance-based identification system, can be used with a remote control circuit
• Alarm output (AL)	: DC 5V, 5.7 k Ω (Low output)
• Switching input (SW)	: 1 low input, for switching signal from SW OUT of a timelapse VCR (as per this manufacturer specifications)
RS-232C terminal	: 9-pin D-SUB
Monitor on-screen display	: Title (up to 10 characters), date, time selectable
Menu settings	: 9 menus screens
Video alarm sensor	: Internal, 8 channel (each camera input, selectable)
Back-up function	: Back-up for up to 30 days of the clock settings after connected for 30 hours continuously
Operations	
• Still	: Available for camera live in quad screen, full screen and zoomed in picture Can be set using a menu to operate automatically when there is an alarm trigger
• 2x zoom	: Available for camera live in quad screen
Display automatic switching speed	: 8 settings (1, 2, 3, 4, 5, 10, 20 and 30 seconds interval) available in full screen mode and quad screen A and B
Power	: AC 220 – 240 v, 50 Hz
Consumption	: 16 W (VQC-801P), 14 W (VQM-801P)
Operating temperature range	: 5 to 40°C
Operating humidity range	: 10 to 80%
Dimensions	: 420 (W) x 44 (H) x 325 (D) mm
Weight	: Approx. 3.4 kg



SANYO Electric Co., Ltd.

1AC6P1P2092--
L8QR5, L8QS5/XE (0799KP-NI01)

Printed in Japan