

Multimedia Projector

MODEL **PLC-SW10**

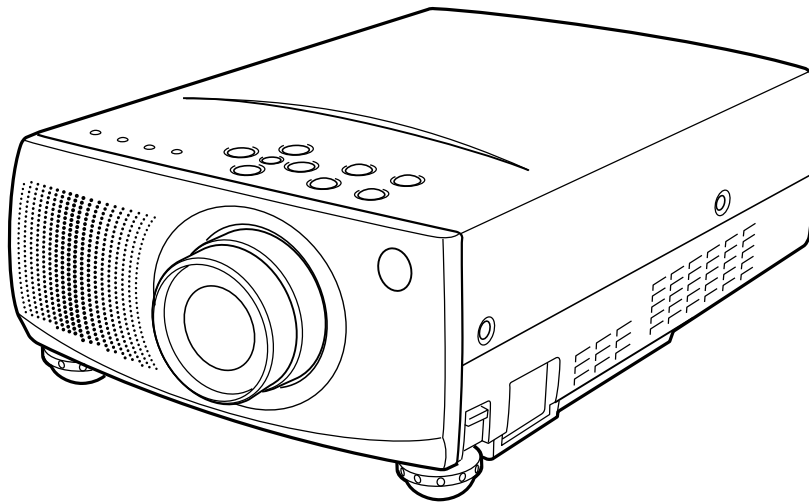

Owner's Manual

TO THE OWNER

Before operating this projector, read this manual thoroughly and operate the projector properly.

This projector provides many convenient features and functions. Operating the projector properly enables you to manage those features and maintains it in better condition for a considerable time.

Improper operation may result in not only shortening the product-life, but also malfunctions, fire hazard, or other accidents.

If your projector seems to operate improperly, read this manual again, check operations and cable connections and try the solutions in the “Trouble-shooting” section of the end of this booklet. If the problem still persists, contact the sales dealer where you purchased the projector or the service center.



SAFETY PRECAUTIONS

WARNING : TO REDUCE THE RISK OF FIRE OR ELECTRIC SHOCK, DO NOT EXPOSE THIS APPLIANCE TO RAIN OR MOISTURE.

- This projector produces intense light from the projection lens. Do not stare directly into the lens as possible. Eye damage could result. Be especially careful that children do not stare directly into the beam.
- This projector should be set in the way indicated. If not, it may result in a fire hazard.
- Take appropriate space on the top, sides and rear of the projector cabinet for allowing air circulation and cooling the projector. Minimum distance should be taken. If the projector is to be built into a compartment or similarly enclosed, the minimum distances must be maintained. Do not cover the ventilation slot on the projector. Heat build-up can reduce the service life of your projector, and can also be dangerous.
- Do not put any flammable object or spray can near the projector, hot air is exhausted from the ventilation holes.
- If the projector is not to be used for an extended time, unplug the projector from the power outlet.

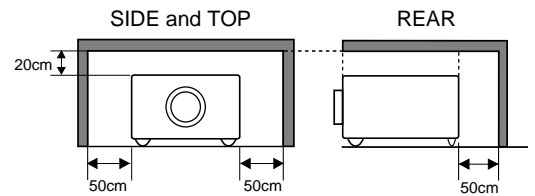

READ AND KEEP THIS OWNER'S MANUAL FOR LATER USE.



CAUTION
RISK OF ELECTRIC SHOCK
DO NOT OPEN



CAUTION : TO REDUCE THE RISK OF ELECTRIC SHOCK, DO NOT REMOVE COVER (OR BACK). NO USER-SERVICEABLE PARTS INSIDE EXCEPT LAMP REPLACEMENT. REFER SERVICING TO QUALIFIED SERVICE PERSONNEL.



THIS SYMBOL INDICATES THAT DANGEROUS VOLTAGE CONSTITUTING A RISK OF ELECTRIC SHOCK IS PRESENT WITHIN THIS UNIT.



THIS SYMBOL INDICATES THAT THERE ARE IMPORTANT OPERATING AND MAINTENANCE INSTRUCTIONS IN THE OWNER'S MANUAL WITH THIS UNIT.

SAFETY INSTRUCTIONS

All the safety and operating instructions should be read before the product is operated.

Read all of the instructions given here and retain them for later use. Unplug this projector from AC power supply before cleaning. Do not use liquid or aerosol cleaners. Use a damp cloth for cleaning.

Follow all warnings and instructions marked on the projector.

For added protection to the projector during a lightning storm, or when it is left unattended and unused for long periods of time, unplug it from the wall outlet. This will prevent damage due to lightning and power line surges.

Do not expose this unit to rain or use near water... for example, in a wet basement, near a swimming pool, etc...

Do not use attachments not recommended by the manufacturer as they may cause hazards.

Do not place this projector on an unstable cart, stand, or table. The projector may fall, causing serious injury to a child or adult, and serious damage to the projector. Use only with a cart or stand recommended by the manufacturer, or sold with the projector. Wall or shelf mounting should follow the manufacturer's instructions, and should use a mounting kit approved by the manufacturers.

An appliance and cart combination should be moved with care. Quick stops, excessive force, and uneven surfaces may cause the appliance and cart combination to overturn.



Slots and openings in the back and bottom of the cabinet are provided for ventilation, to insure reliable operation of the equipment and to protect it from overheating.

The openings should never be covered with cloth or other materials, and the bottom opening should not be blocked by placing the projector on a bed, sofa, rug, or other similar surface. This projector should never be placed near or over a radiator or heat register.

This projector should not be placed in a built-in installation such as a book case unless proper ventilation is provided.

Never push objects of any kind into this projector through cabinet slots as they may touch dangerous voltage points or short out parts that could result in a fire or electric shock. Never spill liquid of any kind on the projector.

This projector should be operated only from the type of power source indicated on the marking label. If you are not sure of the type of power supplied, consult your authorized dealer or local power company.

Do not overload wall outlets and extension cords as this can result in fire or electric shock. Do not allow anything to rest on the power cord. Do not locate this projector where the cord may be damaged by persons walking on it.

Do not attempt to service this projector yourself as opening or removing covers may expose you to dangerous voltage or other hazards. Refer all servicing to qualified service personnel.

Unplug this projector from wall outlet and refer servicing to qualified service personnel under the following conditions:

- a. When the power cord or plug is damaged or frayed.
- b. If liquid has been spilled into the projector.
- c. If the projector has been exposed to rain or water.
- d. If the projector does not operate normally by following the operating instructions. Adjust only those controls that are covered by the operating instructions as improper adjustment of other controls may result in damage and will often require extensive work by a qualified technician to restore the projector to normal operation.
- e. If the projector has been dropped or the cabinet has been damaged.
- f. When the projector exhibits a distinct change in performance-this indicates a need for service.

When replacement parts are required, be sure the service technician has used replacement parts specified by the manufacturer that have the same characteristics as the original part. Unauthorized substitutions may result in fire, electric shock, or injury to persons.

Upon completion of any service or repairs to this projector, ask the service technician to perform routine safety checks to determine that the projector is in safe operating condition.

Voor de klanten in Nederland



Bij dit product zijn batterijen geleverd. Wanneer deze leeg zijn, moet u ze niet weggooien maar inleveren als KCA.

COMPLIANCES

Federal Communication Commission Notice

This equipment has been tested and found to comply with the limits for a Class A digital device, pursuant to Part 15 of FCC Rules. These limits are designed to provide reasonable protection against harmful interference when the equipment is operated in a commercial environment. This equipment generates, uses, and can radiate radio frequency energy and, if not installed and used in accordance with the instruction manual, may cause harmful interference to radio communications. Operation of this equipment in a residential area is likely to cause harmful interference in which case the user will be required to correct the interference at his own expense.

AC POWER CORD REQUIREMENT

The AC Power Cord supplied with this projector meets the requirement for use in the country you purchased it.

AC Power Cord for the United States and Canada :

AC Power Cord used in the United States and Canada is listed by the Underwriters Laboratories (UL) and certified by the Canadian Standard Association (CSA). AC Power Cord has a grounding-type AC line plug. This is a safety feature to be sure that the plug will fit into the power outlet. Do not try to defeat this safety feature. Should you be unable to insert the plug into the outlet, contact your electrician.

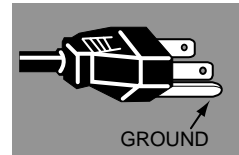

AC Power Cord for the United Kingdom :

This cord is already fitted with a moulded plug incorporating a fuse, the value of which is indicated on the pin face of the plug. Should the fuse need to be replaced, an ASTA approved BS 1362 fuse must be used of the same rating, marked thus \diamond . If the fuse cover is detachable, never use the plug with the cover omitted. If a replacement fuse cover is required, ensure it is of the same colour as that visible on the pin face of the plug (i.e. red or orange). Fuse covers are available from the Parts Department indicated in your User Instructions. If the plug supplied is not suitable for your socket outlet, it should be cut off and destroyed. The end of the flexible cord should be suitably prepared and the correct plug fitted. (See Over)

WARNING : A PLUG WITH BARED FLEXIBLE CORD IS HAZARDOUS IF ENGAGED IN A LIVE SOCKET OUTLET.

The Wires in this mains lead are coloured in accordance with the following code:

Green-and-yellow Earth
Blue Neutral
Brown Live

As the colours of the wires in the mains lead of this apparatus may not correspond with the coloured markings identifying the terminals in your plug proceed as follows:

The wire which is coloured green-and-yellow must be connected to the terminal in the plug which is marked by the letter E or by the safety earth symbol \perp or coloured green or green-and-yellow.

The wire which is coloured blue must be connected to the terminal which is marked with the letter N or coloured black.

The wire which is coloured brown must be connected to the terminal which is marked with the letter L or coloured red.

WARNING : THIS APPARATUS MUST BE EARTHED.

THE SOCKET-OUTLET SHOULD BE INSTALLED NEAR THE EQUIPMENT AND EASILY ACCESSIBLE.

TABLE OF CONTENTS

FEATURES AND DESIGN	6	COMPUTER MODE	22
PREPARATION	7	SELECTING COMPUTER MODE	22
NAME OF EACH PART OF THE PROJECTOR	7	SELECTING COMPUTER SYSTEM	22
SETTING-UP THE PROJECTOR	8	COMPATIBLE COMPUTER SPECIFICATIONS	23
CONNECTING THE AC POWER CORD	8	PC ADJUSTMENT	24
POSITIONING THE PROJECTOR	9	PICTURE IMAGE ADJUSTMENT	26
ADJUSTABLE FEET	9	ADJUST PICTURE IMAGE MANUALLY	26
MOVING THE PROJECTOR	10	NORMAL FUNCTION	26
		AUTO IMAGE FUNCTION	27
		PICTURE POSITION ADJUSTMENT	27
		PICTURE SCREEN ADJUSTMENT	28
CONNECTING THE PROJECTOR	11	VIDEO MODE	29
TERMINALS OF THE PROJECTOR	11	SELECTING VIDEO MODE	29
CONNECTING TO THE VIDEO EQUIPMENT	12	SELECTING VIDEO SOURCE	29
CONNECTING TO THE COMPUTER	13	SELECTING COLOR SYSTEM	30
		PICTURE SCREEN ADJUSTMENT	30
		PICTURE IMAGE ADJUSTMENT	31
		ADJUSTING THE PICTURE IMAGE MANUALLY	31
		NORMAL FUNCTION	31
BEFORE OPERATION	14	SETTING	32
OPERATION OF THE REMOTE CONTROL	14	SETTING MENU	32
OPERATING RANGE	14	SETTING LANGUAGE	33
REMOTE CONTROL BATTERIES INSTALLATION	15		
TOP CONTROLS AND INDICATORS	16		
OPERATING ON-SCREEN MENU	17		
HOW TO OPERATE THE ON-SCREEN MENU	17		
FLOW OF ON-SCREEN MENU	17		
MENU BAR	18		
BASIC OPERATION	19	APPENDIX	34
TURNING ON / OFF THE PROJECTOR	19	OPERATING WIRELESS MOUSE	34
ADJUSTING THE IMAGE	20	MAINTENANCE	35
ZOOM ADJUSTMENT	20	TEMPERATURE WARNING INDICATOR	35
FOCUS ADJUSTMENT	20	AIR FILTER CARE AND CLEANING	35
KEY STONE ADJUSTMENT	20	CLEANING THE PROJECTION LENS	35
NO SHOW FUNCTION	21	LAMP REPLACEMENT	36
PICTURE FREEZE FUNCTION	21	LAMP REPLACEMENT MONITOR TIMER	36
P-TIMER FUNCTION	21	TROUBLESHOOTING	37
SOUND ADJUSTMENT	21	TECHNICAL SPECIFICATIONS	39
SOUND VOLUME ADJUSTMENT	21		
SOUND MUTE ADJUSTMENT	21		

TRADEMARKS

- Apple, Macintosh, and PowerBook are trademarks or registered trademarks of Apple Computer, Inc.
- IBM and PS/2 are trademarks or registered trademarks of International Business Machines, Inc.
- Windows and PowerPoint are registered trademarks of Microsoft Corporation.
- Each name of corporations or products in the owner's manual is a trademark or a registered trademark of its respective corporation.

FEATURES AND DESIGN

This Multimedia Projector is designed with the most advanced technology for portability, durability, and ease of use. The projector utilizes built-in multimedia features, a palette of 16.77 million colors, and matrix liquid crystal display (LCD) technology.

◆ Compact Design

This projector is extremely compact in size and weight. It is designed to carry and work anywhere you wish to use.

◆ Compatibility

This projector widely accepts various video and computer input signals including;

- **Computers**

IBM-compatible and Macintosh computers up to 1280 x 1024 resolution.

- **6 Color Systems**

NTSC, PAL, SECAM, NTSC 4.43, PAL-M or PAL-N color system can be connected.

- **Component Video**

Component video signals, such as a DVD player output high definition TV signals including 480i, 480p, 575i, 575p, 720p, 1035i or 1080i, can be connected.

- **S-Video**

S-Video signals, such as a S-VHS VCR output signals, can be connected.

◆ High Resolution Image

This projector provides 800 x 600 dots resolution for computer input and 500 horizontal TV lines. The resolution from the computer between SVGA (800 x 600) and SXGA (1280 x 1024) is compressed into 800 x 600 dots. This projector cannot display image of over 1280 x 1024 dots. When the resolution of your computer is over than 1280 x 1024, reset the computer output for lower resolution.

◆ Multilanguage Menu Display

Operation menu is displayed in; English, Deutsch, Français, Italiano, Español, or Japanese.

◆ Multi-Scan System

This projector has Multi-Scan System to conform to almost all computer output signals quickly. There is no need for troublesome manual adjustment of frequency and other settings.

◆ One-Touch Auto Imaging

Incoming computer video signals are recognized and the best setting is automatically selected by the Auto Image function.

No complicated setup is necessary and projection is always precise.

◆ Digital Zoom (Computer Mode only)

The Digital Zoom magnifies the image up to 16 times, allowing you to focus on crucial information at a presentation.

◆ Keystone Correction

Positioning height of the projector may result in distorted images being displayed in a trapezoid shape. Keystone Correction solves this problem by digitally altering the projection to produce undistorted images.

◆ Power Management

Power Management function is provided to reduce power consumption while the projector is not in use.

This Power Management function operates to turn the Projection Lamp off when the projector detects signal interruption and any button is not pressed over 5 minutes. The Projection Lamp is automatically turned on again when the projector detects the signal or any operation button is pressed.

This projector is shipped with this function ON.

◆ Wireless Mouse

The Remote Control Unit supplied with this projector has Wireless Mouse function for the connected computer. This function enables you to operate both projector and computer with this Remote Control Unit only.

PREPARATION

NAME OF EACH PART OF THE PROJECTOR

FRONT OF THE CABINET

PROJECTION LENS

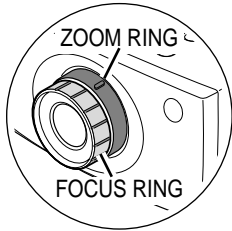

SPEAKER (Monaural)

LENS COVER

INFRARED REMOTE RECEIVER

AIR INTAKE VENTS (Both sides and Rear)

This projector is equipped with cooling fans for protection from overheating. Pay attention to the following to ensure proper ventilation and avoid a possible risk of fire and malfunction.

- Do not cover the vent slot.
- Keep sides and rear clear of any obstructions. Obstructions may block cooling air.

POWER CORD CONNECTOR

BACK OF THE CABINET

EXHAUST VENT



HOT AIR EXHAUSTED !

Air blown from the exhaust vent is hot. When using or installing the projector, the following precautions should be taken.

- Do not put a flammable object near this vent.
- Keep the side grills at least 3' (1m) away from any object, especially heat-sensitive object.
- Do not touch this area, especially screws and metallic parts. This area will become hot while the projector is used.

This projector detects the internal temperature and automatically controls the operating power of the Cooling Fans.

TERMINALS AND CONNECTORS

BOTTOM OF THE CABINET

LAMP COVER

AIR INTAKE VENTS AND AIR FILTERS

These Air Intake Vents should not be blocked.

ADJUSTABLE FEET AND FEET LOCK LATCHES

SETTING-UP THE PROJECTOR

CONNECTING THE AC POWER CORD

This projector uses nominal input voltages of 100-120 V or 200-240 V AC. The projector automatically selects the correct input voltage. It is designed to work with single-phase power systems having a grounded neutral conductor. To reduce the risk of electrical shock, do not plug into any other type of power system. Consult your authorized dealer or service station if you are not sure of the type of power supply being in use. Connect the projector with the peripheral equipment before turning the projector on. (Refer to pages 11 ~ 13 for connection.)

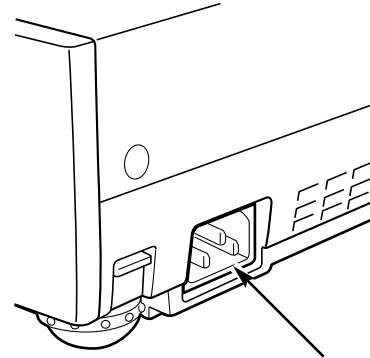

Connect the AC Power Cord (supplied) to the projector. The AC outlet must be near this equipment and must be easily accessible.



CAUTION

For safety, unplug the AC Power Cord when the appliance is not used. When this projector is connected to the outlet with the AC Power Cord, the appliance is in Stand-by Mode and consumes a little electric power.

NOTE ON THE POWER CORD

The AC Power Cord must meet the requirement of the country where you use the projector. Confirm the AC plug type with the chart below and the proper AC power cord must be used. If the supplied AC Power Cord does not match the AC outlet, contact your sales dealer.

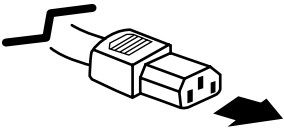
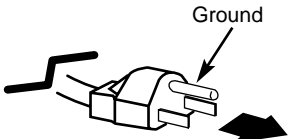
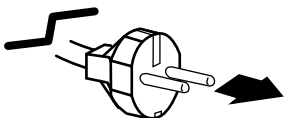
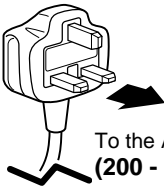
Projector side	AC Outlet side		
 <p data-bbox="240 1507 456 1581">To the POWER CORD CONNECTOR on the projector.</p>	<p data-bbox="493 1308 792 1339">For the U.S.A. and Canada</p>  <p data-bbox="623 1514 792 1570">To the AC Outlet. (120 V AC)</p>	<p data-bbox="829 1308 1128 1339">For Continental Europe</p>  <p data-bbox="946 1528 1131 1585">To the AC Outlet. (200 - 240 V AC)</p>	<p data-bbox="1230 1308 1367 1339">For the U.K.</p>  <p data-bbox="1279 1507 1464 1564">To the AC Outlet. (200 - 240 V AC)</p>

POSITIONING THE PROJECTOR

- This projector is designed to project on a flat projection surface.
- The projector can be focused from 4.6'(1.4m) ~ 26.3'(8.0m).
- Refer to the figure below to adjust the screen size.

ROOM LIGHT

The brightness in the room has a great influence on the picture quality. It is recommended to limit ambient lighting in order to provide the best image.

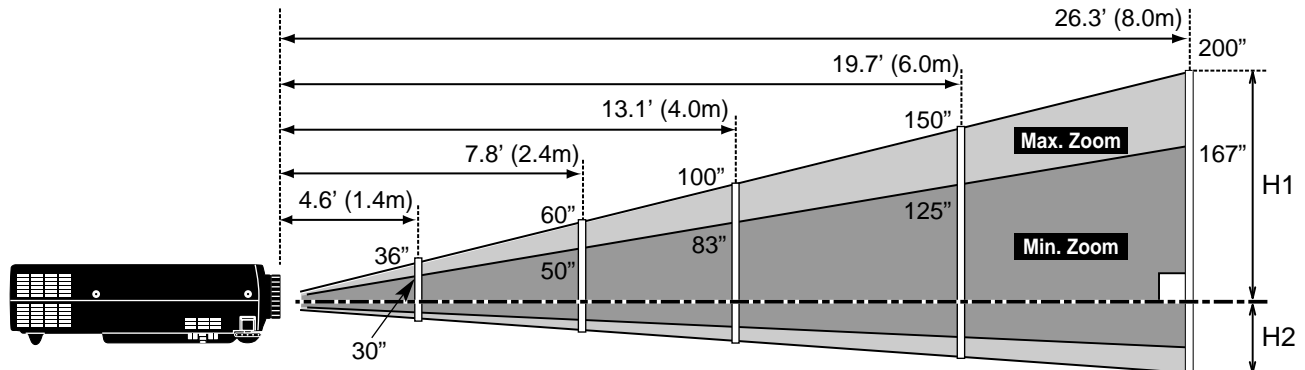

Screen Size (W x H) mm	30"	60"	100"	150"	200"
Height (H1)	16.61"(422mm)	33.2"(844mm)	55.4"(1407mm)	83.1"(2110mm)	110.8"(2814mm)
Height (H2)	1.38"(35mm)	2.8"(70mm)	4.6"(117mm)	6.9"(176mm)	9.2"(234mm)

ADJUSTABLE FEET

Picture tilt and projection angle can be adjusted by rotating the ADJUSTABLE FEET. Projection angle can be adjusted to 7.6 degrees.

- 1** Lift the front of the projector and pull the FEET LOCK LATCHES on both sides of the projector.
- 2** Release the FEET LOCK LATCHES to lock the ADJUSTABLE FEET and rotate the ADJUSTABLE FEET to fine tune the position and the tilt.
- 3** To shorten the ADJUSTABLE FEET, lift the front of the projector and pull and undo the FEET LOCK LATCHES.

The position and the keystone distortion of the image can be adjusted using the Menu Operation. (Refer to P 20, 28 and 30.)

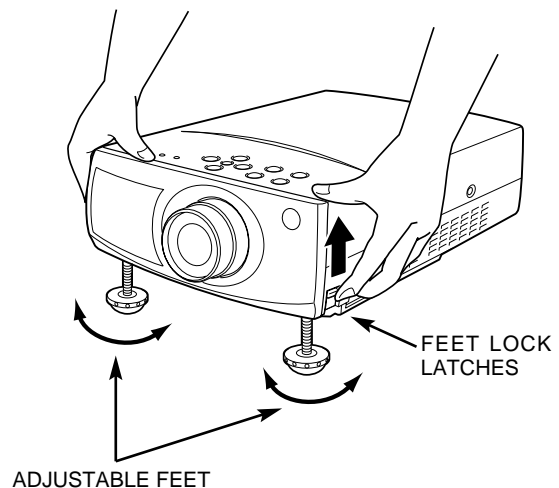

MOVING THE PROJECTOR

When moving the projector, replace the lens cover and retract the feet to prevent damage to the lens and cabinet.

When this projector is not in use for an extended period, put it into the case (carrying bag) supplied with this projector.



CAUTION

The Carrying Bag (supplied) is intended for protection from dust and scratches on the surface of the cabinet, and it is not designed to protect the LCD projector from external forces. Do not transport the projector through a courier or transport services with this bag. The projector can be damaged. When handling the projector, do not drop or bump the projector, subject it to strong forces or put other things on the cabinet.



CAUTION IN CARRYING OR TRANSPORTING THE PROJECTOR

- Do not drop or bump the projector, otherwise damages or malfunctions may result.
- When carrying the projector, use a suitable carrying case.
- Do not transport the projector by using a courier or transport service in an unsuitable transport case. This may cause damage to the projector. To transport the projector through a courier or transport service, consult your dealer for best way.

CONNECTING THE PROJECTOR

TERMINALS OF THE PROJECTOR

VIDEO INPUT JACKS (VIDEO/Y, Pb/Cb, Pr/Cr)

Connect the composite video output from the video equipment to the VIDEO/Y jack or connect the component video outputs to the Y/VIDEO, Pb/Cb and Pr/Cr jacks. (Refer to P12.)

RESET BUTTON

This projector uses a micro processor to control the unit. Occasionally, the micro processor may malfunction and need to be reset. This can be done by pressing the RESET button with a pen, which will shut down and restart the unit. Do not use the RESET function excessively.

AUDIO OUTPUT JACK (STEREO)

Connect an external audio amplifier to this terminal. (Refer to P12, 13.)

COMPUTER INPUT TERMINAL

Connect the computer output to this terminal. (Refer to P13.)

S-VIDEO INPUT JACK

Connect the S-VIDEO output from the video equipment to this terminal. (Refer to P12.)

AUDIO INPUT JACK

Connect the audio output from the video equipment to this terminal. (Refer to P12.)

COMPUTER AUDIO INPUT JACK

Connect the audio output from the computer to this terminal. (Refer to P13.)

CONTROL PORT CONNECTOR

When controlling the computer with the Remote Control of this projector, connect the mouse port of your personal computer to this terminal. (Refer to P13.)

COMPUTER INPUT TERMINAL

Terminal : HDB15-PIN

Connect the display output terminal of the computer to COMPUTER INPUT terminal of this projector with the VGA Cable (supplied). When connecting the Macintosh computer, the MAC Adapter (not supplied) is required.

Pin Configuration

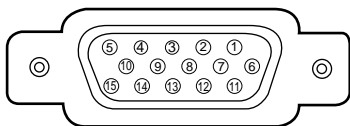

1	Red Input	9	No Connect
2	Green Input	10	Ground (Vert.sync.)
3	Blue Input	11	Sense 0
4	Sense 2	12	Sense 1
5	Ground (Horiz.sync.)	13	Horiz. sync.
6	Ground (Red)	14	Vert. sync.
7	Ground (Green)	15	Reserved
8	Ground (Blue)		

CONTROL PORT CONNECTOR

Terminal : DIN 8-PIN

Connect control port (PS/2, Serial or ADB port) on your computer to this terminal with the Control Cable (the Control Cable for PS/2 port is supplied).

Pin Configuration

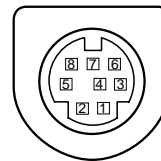

	PS/2	Serial	ADB
1	----	R X D	----
2	CLK	----	ADB
3	DATA	----	----
4	GND	GND	GND
5	----	RTS	----
6	----	T X D	----
7	GND	GND	----
8	----	GND	GND

CONNECTING TO THE VIDEO EQUIPMENT

Cables used for connection (* = Cables are not supplied with this projector.)

- Video Cable (RCA x 1 or RCA x 3) *
- S-VIDEO Cable *
- Audio Cable (RCA x 2- Mini Plug x 1 (stereo) or Mini Plug (stereo)) *

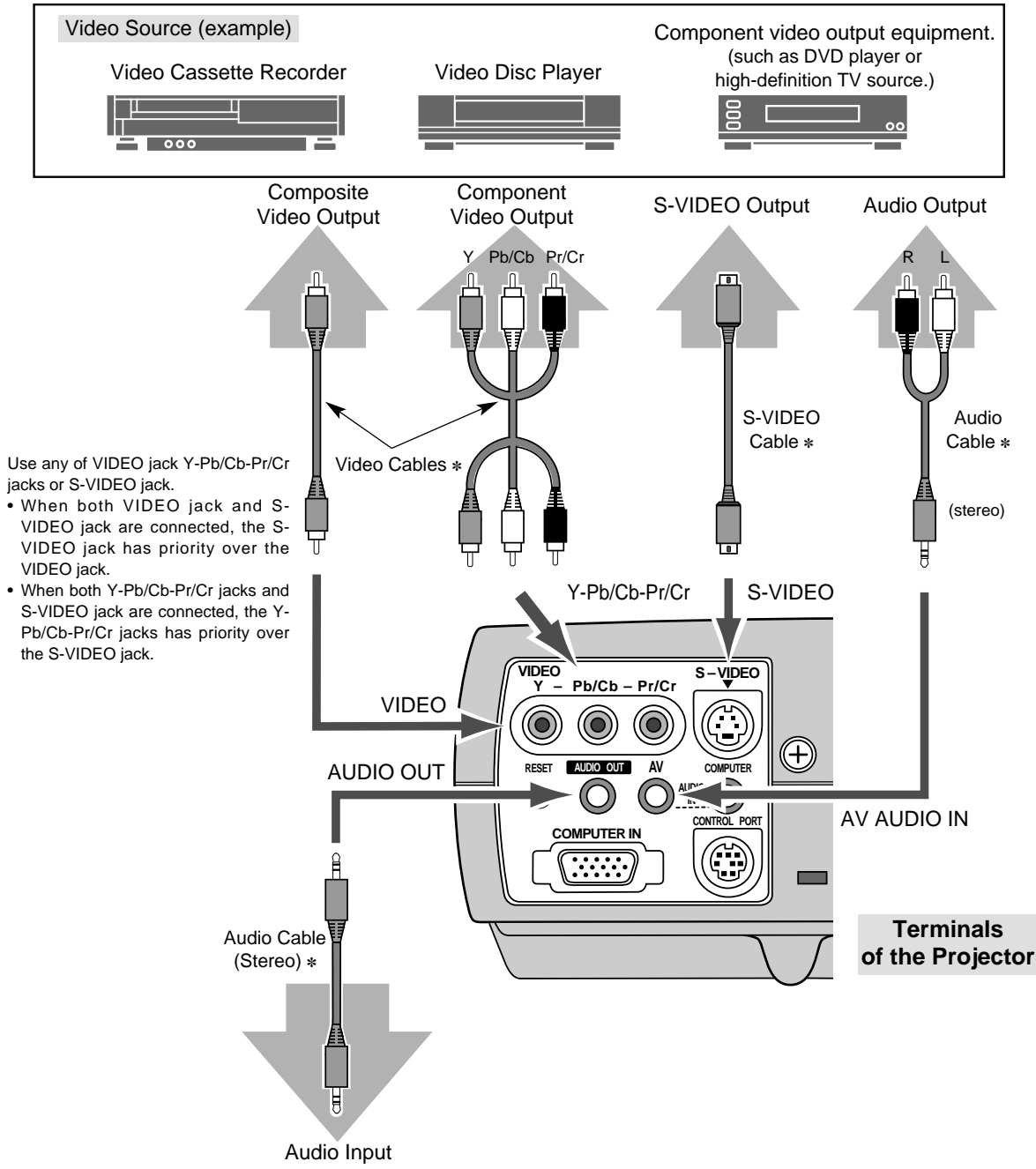

NOTE :
 When connecting the cable, the power cords of both the projector and the external equipment should be disconnected from AC outlet. Turn the projector and peripheral equipment on before the computer is switched on.

CONNECTING TO THE COMPUTER

Cables used for connection (* = Cables are not supplied with this projector.)

- VGA CABLE (HDB 15 pin)
- CONTROL CABLE FOR PS/2 PORT
- CONTROL CABLE FOR SERIAL PORT, or ADB PORT *
- MAC ADAPTER (When connecting to Macintosh computer) *
- AUDIO CABLE (Mini Plug (stereo)) *



NOTE :

When connecting the cable, the power cords of both the projector and the external equipment should be disconnected from AC outlet. Turn the projector and peripheral equipment on before the computer is switched on.

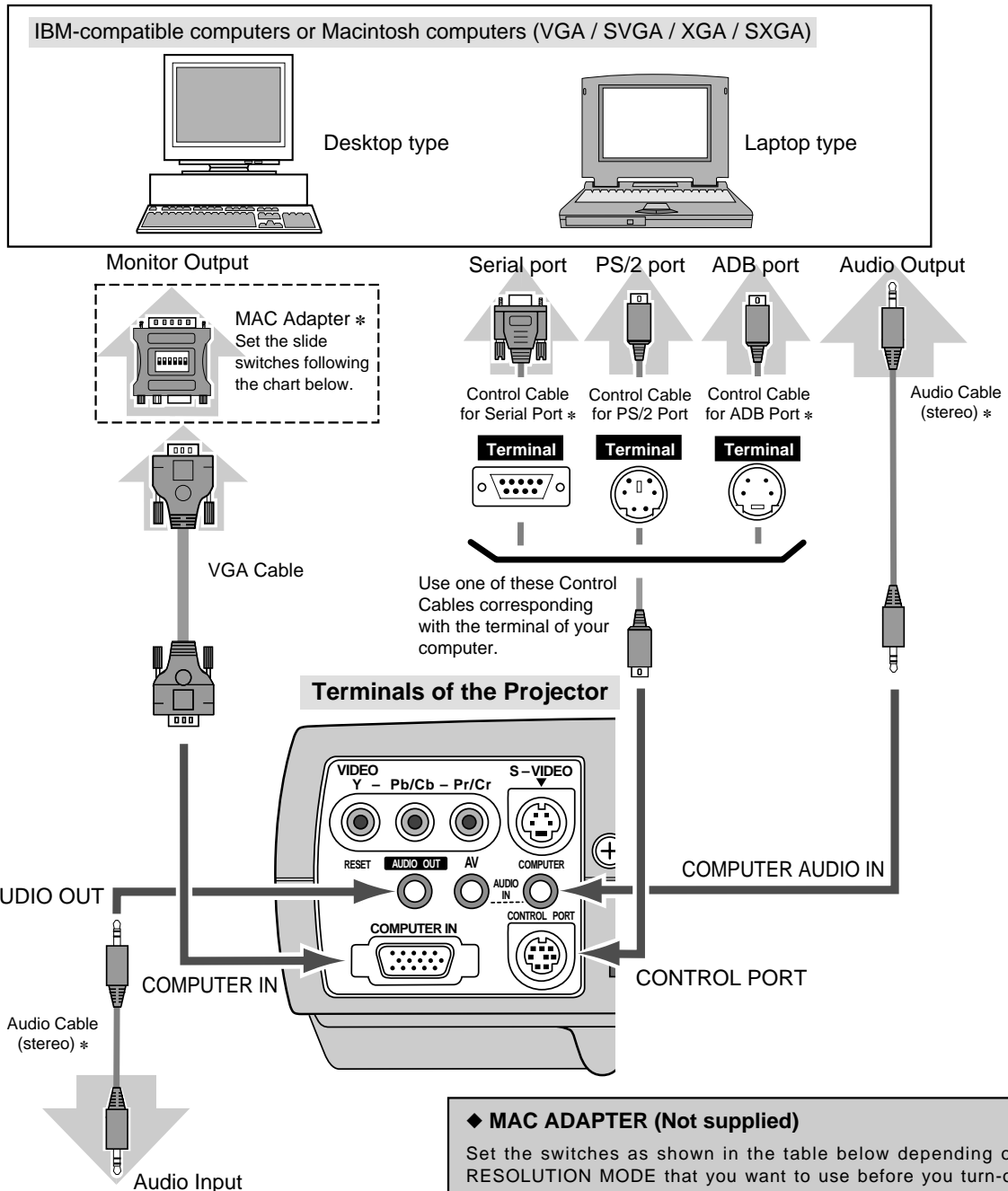

◆ MAC ADAPTER (Not supplied)

Set the switches as shown in the table below depending on the RESOLUTION MODE that you want to use before you turn-on the projector and computer.

	1	2	3	4	5	6
13" MODE (640 x 480)	ON	ON	OFF	OFF	OFF	OFF
16" MODE (832 x 624)	OFF	ON	OFF	ON	OFF	OFF
19" MODE (1024 x 768)	OFF	ON	ON	OFF	OFF	OFF
21" MODE (1152 x 870)	ON	ON	ON	ON	OFF	OFF

BEFORE OPERATION

OPERATION OF THE REMOTE CONTROL

Left Side

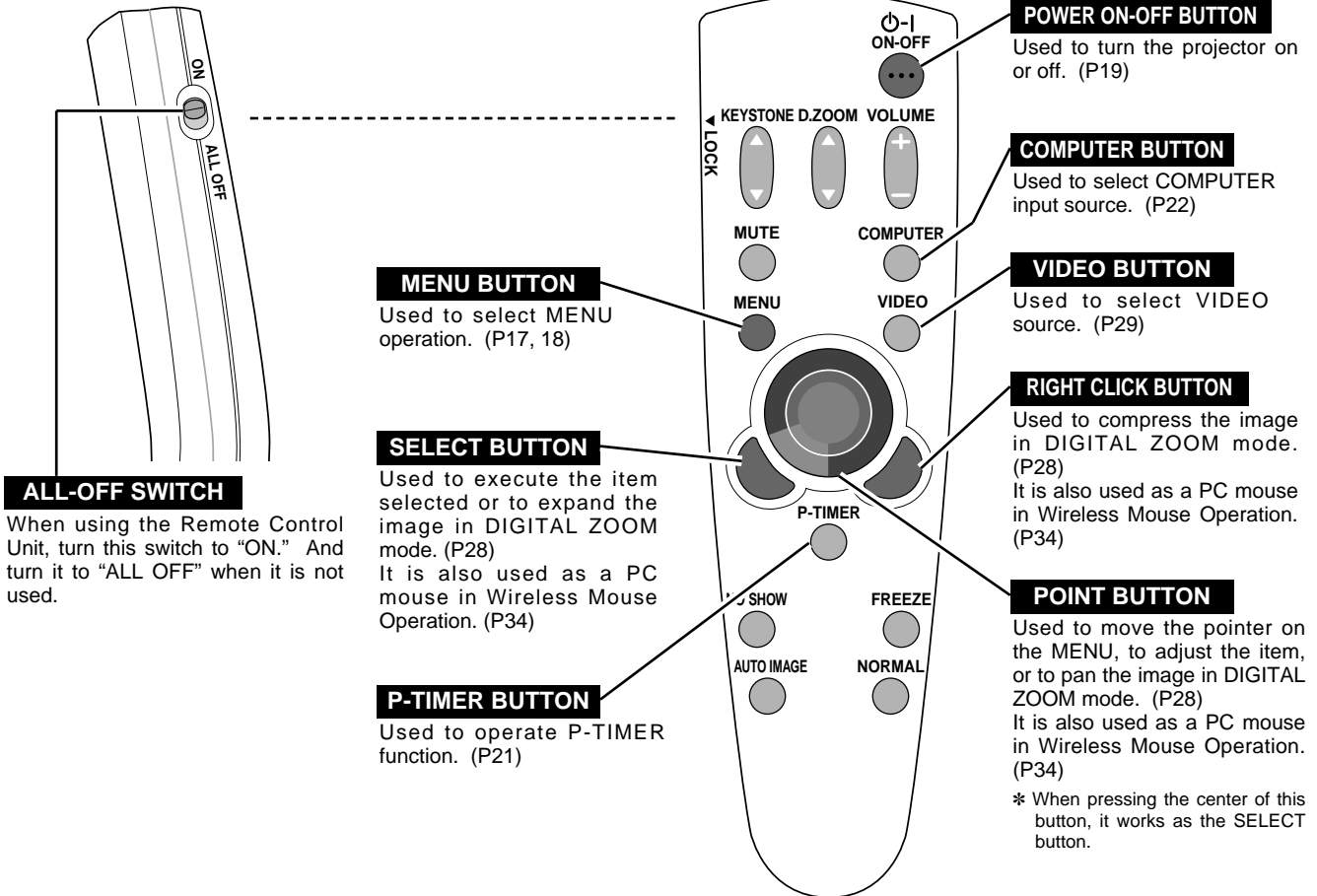

Operating Range

Point the remote control toward the projector (the Remote Receiver) whenever pressing the buttons. Maximum operating range for the remote control is about 16.4' (5m) and 60° in front of the projector.

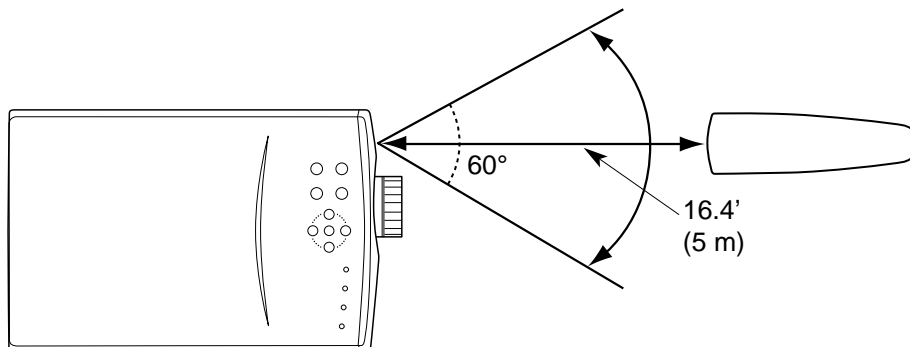

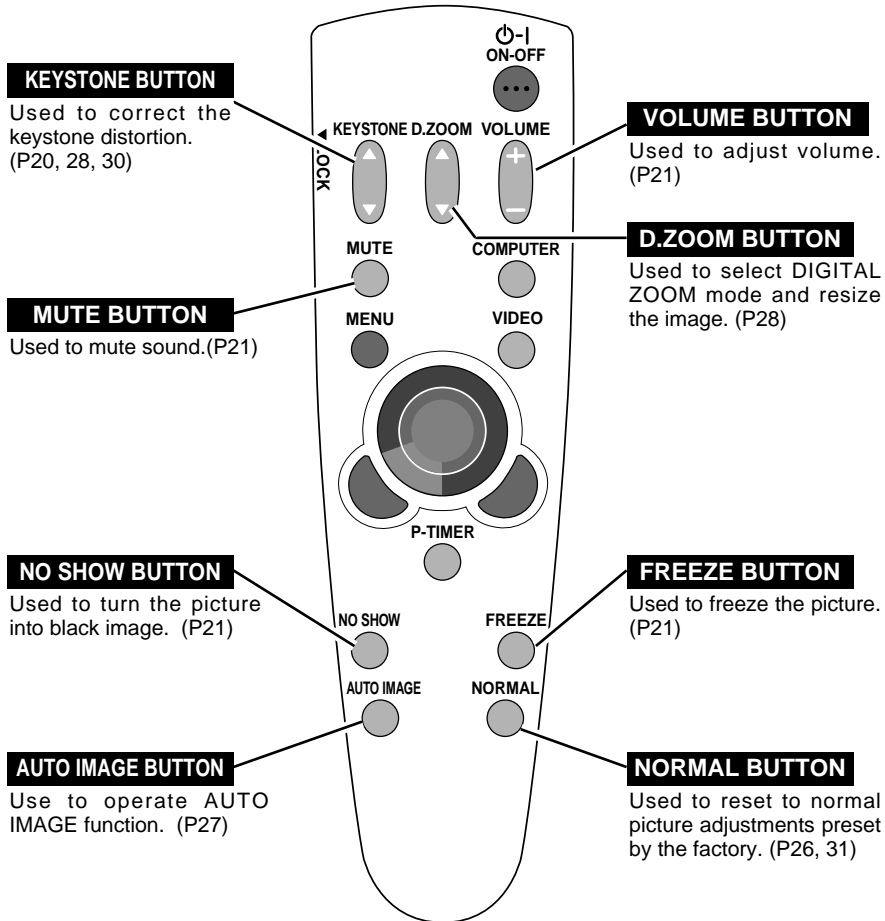

Remote Control Batteries Installation

1 Remove the battery compartment lid.

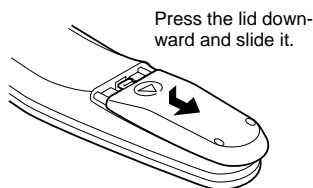

2 Slide the batteries into the compartment.

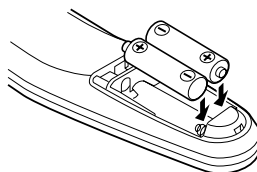

Two AA size batteries
For correct polarity (+ and -), be sure the battery terminals are in contact with the pins in the compartment.

3 Replace the compartment lid.

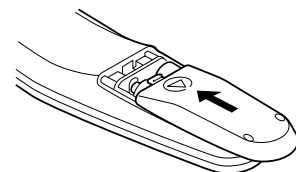

To insure safe operation, please observe the following precautions :

- Use (2) AA, UM3 or R06 type alkaline batteries.
- Replace two batteries at the same time.
- Do not use a new battery with a used battery.
- Avoid contact with water or liquid.
- Do not expose the Remote Control Unit to moisture, or heat.
- Do not drop the remote control unit.
- If batteries have leaked on the remote control, carefully wipe the case clean and load new batteries.

TOP CONTROLS AND INDICATORS

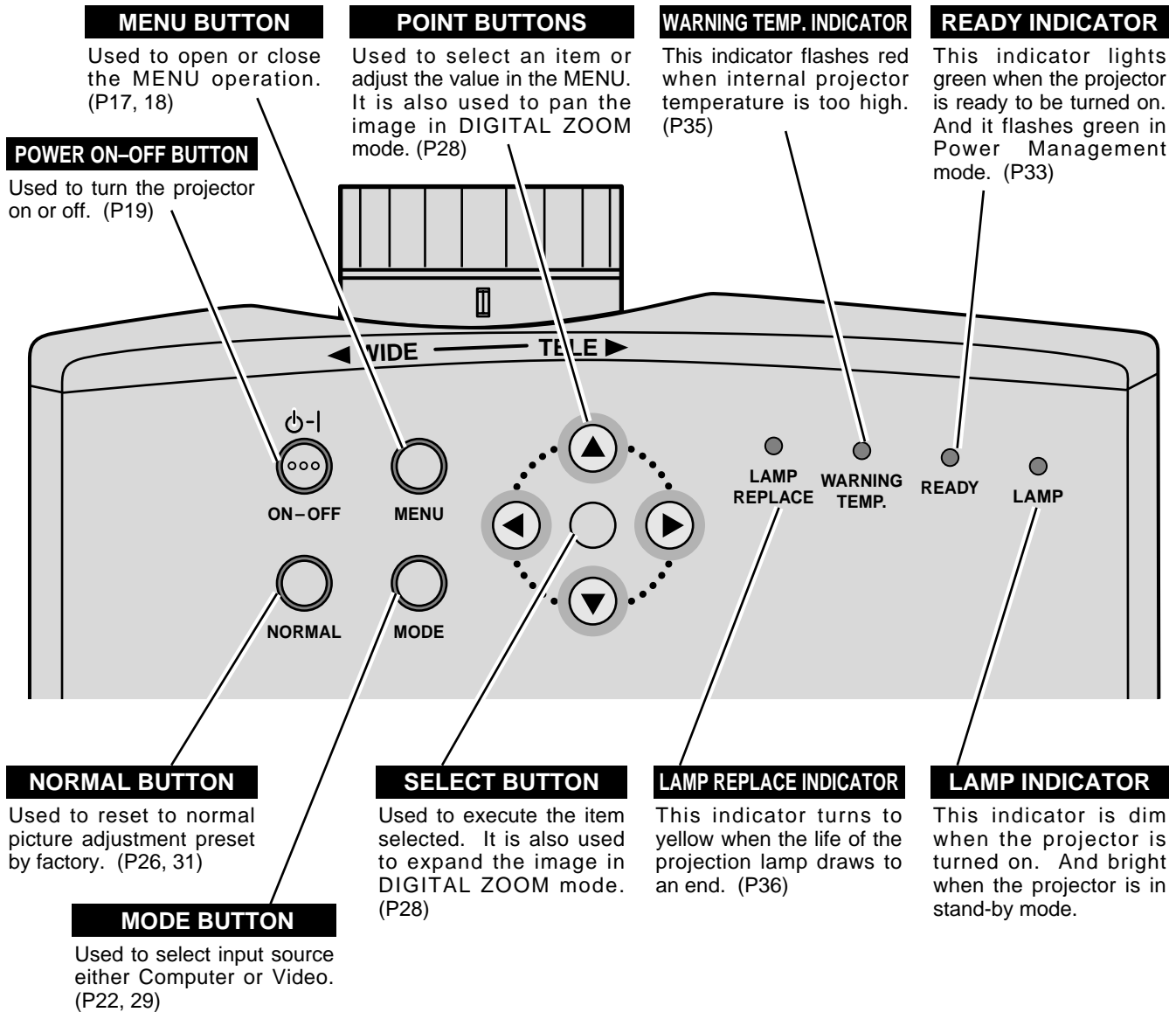

OPERATING ON-SCREEN MENU

HOW TO OPERATE ON-SCREEN MENU

You can control and adjust this projector through the ON-SCREEN MENU. Refer to the following pages to operate each adjustment in the ON-SCREEN MENU.

1 MOVING THE POINTER

Move the pointer (see the NOTE below) by pressing POINT button(s) on the TOP CONTROL or the REMOTE CONTROL.

2 SELECT THE ITEM

Select the item by pressing SELECT button.

NOTE : Pointer is the icon on the ON-SCREEN Menu to select the item. See the figures on the section "FLOW OF ON-SCREEN MENU" below.

WIRELESS REMOTE CONTROL

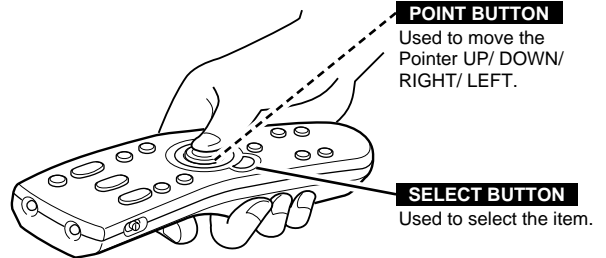

TOP CONTROL

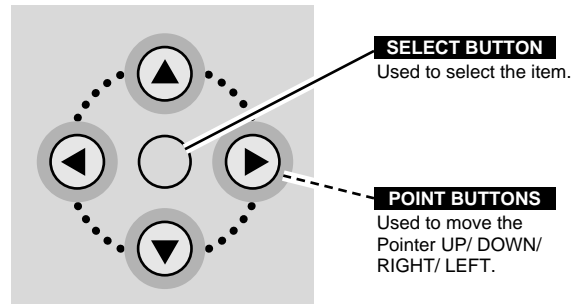

FLOW OF ON-SCREEN MENU

Display ON-SCREEN MENU

1 Press MENU button to display the ON-SCREEN MENU (MENU BAR). The red frame is the POINTER.

Select the Item

2 Move the POINTER (red frame) to the ITEM ICON that you want to select by pressing POINT RIGHT/ LEFT buttons.

3 Select the ITEM by pressing SELECT button. The dialog box of the ITEM appears.

Control and adjust through ON-SCREEN MENU

4 Move the POINTER downward by pressing POINT DOWN button. (The shape of the POINTER becomes an arrow.)

5 Move the POINTER to the ITEM that you want to adjust and adjust the ITEM by pressing SELECT button. Refer to the following pages for details of respective adjustments.

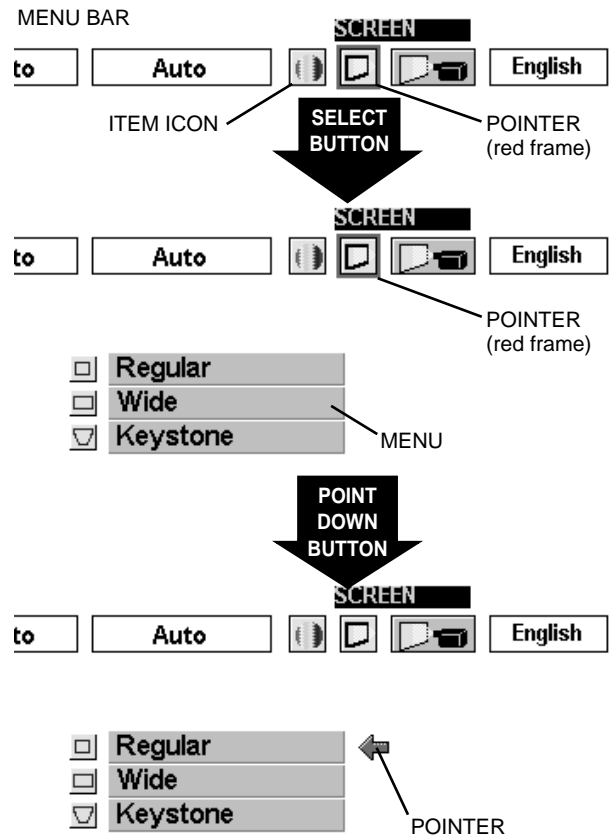

MENU BAR

MENU BAR IN COMPUTER MODE

Press MENU BUTTON while in Computer mode.

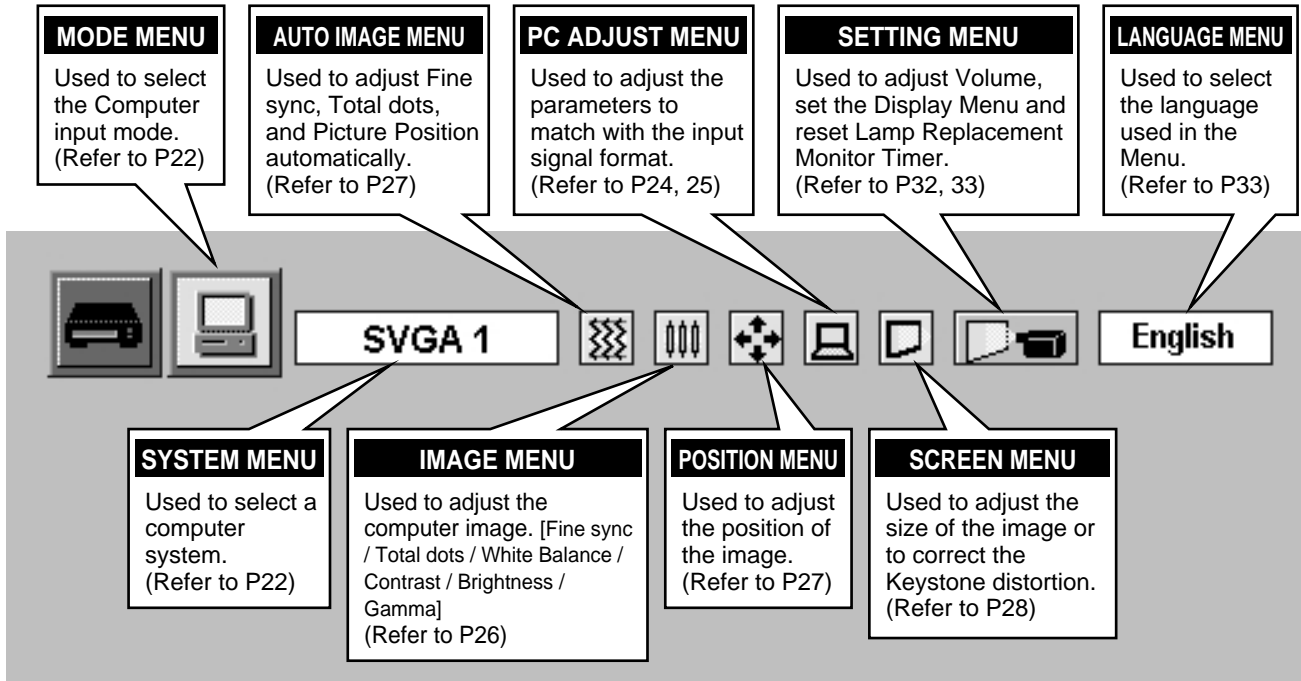

MENU BAR IN VIDEO MODE

Press MENU BUTTON while in Video mode.

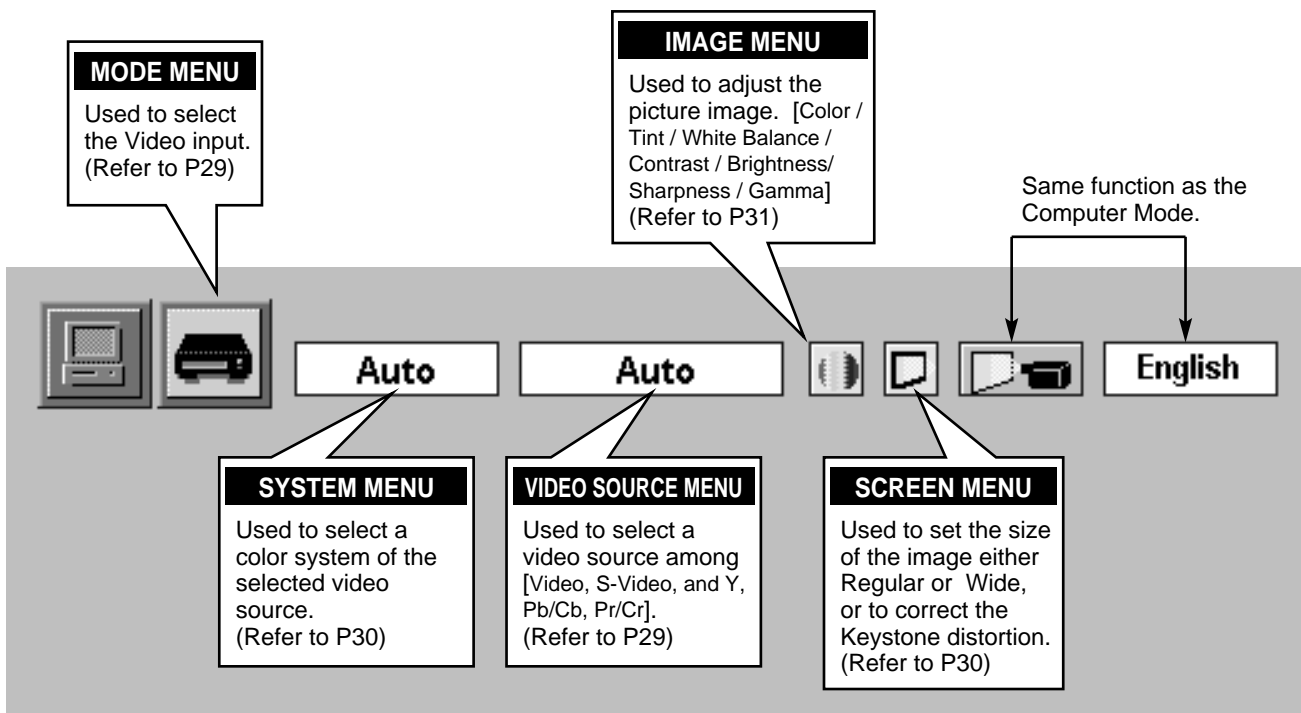

TURNING ON / OFF THE PROJECTOR

TURNING ON THE PROJECTOR

- 1 Complete the peripheral connections (with Computer, VCR, etc.) before turning on the projector. (Refer to "CONNECTING TO THE PROJECTOR" on Pages 11~13 for connecting that equipment.)
- 2 Connect the projector's AC Power Cord into a wall outlet. The LAMP indicator lights RED, and the READY indicator lights GREEN.
- 3 Press the power ON-OFF button on the Remote Control Unit or on the Top Control to ON. The LAMP indicator dims, and the Cooling Fans start to operate. The Preparation Display appears on the screen and the count-down starts. The signal from the source appears after 30 seconds.

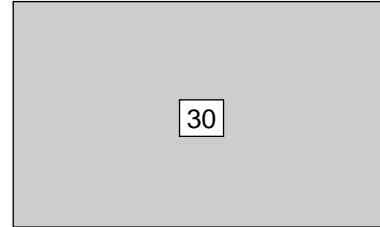

The Preparation Display disappears after 30 seconds.

TURNING OFF THE PROJECTOR

- 1 Press the power ON-OFF button on the Remote Control Unit or on the Top Control, and the message "Power off?" appears on the screen.
- 2 Press the power ON-OFF button again to turn off the projector. The LAMP indicator lights bright and the READY indicator turns off. The Cooling Fans operate for 90 seconds after the projector is turned off. (During this "Cooling Down" period, this appliance cannot be turned on.)
- 3 When the projector has cooled down, the READY indicator turns to green again and you can turn the projector on. After cooling down completely, disconnect the AC power cord.

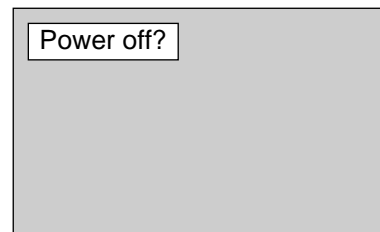

The message disappears after 4 seconds.



TO MAINTAIN THE LIFE OF THE LAMP, ONCE YOU TURN THE PROJECTOR ON, WAIT AT LEAST 5 MINUTES BEFORE TURNING IT OFF.

When the Power Management function is ON, the Projector detects the signal interruption and turns the Projection Lamp off automatically. Refer to "Power Management" on page 33.

When the TEMPERATURE WARNING indicator flashes red, the projector is automatically turned off. Wait at least 5 minutes before turning the projector on again.

When the TEMPERATURE WARNING indicator continues to flash, follow procedures below:

1. Press the power ON-OFF button to turn off the projector and disconnect the AC power cord from the AC outlet.
2. Check the air filters for dust accumulation.
3. Clean the Air Filter. (See "AIR FILTER CARE AND CLEANING" section on page 35.)
4. Press the power ON-OFF button to turn it on.

If the TEMPERATURE WARNING indicator should still continue to flash, contact the sales dealer where you purchased this projector or service center.

NOTE: The Cooling Fan may work for cooling while the projector is turned off. When the Cooling Fan is working, TEMPERATURE WARNING INDICATOR flashes red.

ADJUSTING THE IMAGE

ZOOM ADJUSTMENT

Turn the ZOOM RING to adjust the projected picture size. Turn the ring to "WIDE" direction to make the image larger, and turn to "TELE" direction to make the image smaller.

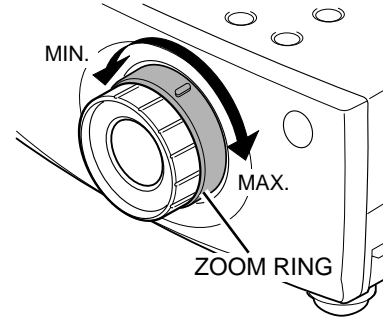

FOCUS ADJUSTMENT

Turn the FOCUS RING to adjust the projected picture focus.

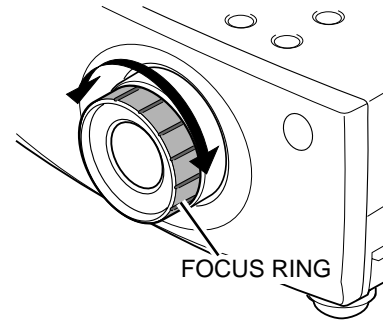

KEYSTONE ADJUSTMENT

If the picture has keystone distortion, correct image with KEYSTONE adjustment.

- 1 Press the KEYSTONE ▲/▼ button on the Remote Control Unit or select the Keystone on the SCREEN menu. (Refer to page 28, 30.) The message "Keystone" is displayed.
- 2 Correct the Keystone distortion by pressing the KEYSTONE ▲/▼ button or the POINT UP/DOWN button(s). Press the KEYSTONE ▲ button or the POINT UP button to reduce the upper part of the image, and press the KEYSTONE ▼ button or the POINT DOWN button to reduce the lower part.

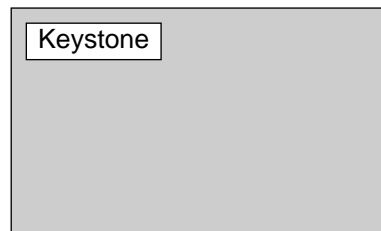

The message disappears after 4 seconds.

Reduce the upper width with the KEY STONE ▲ button or the POINT UP button.

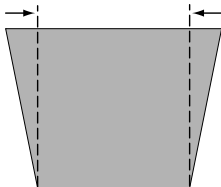

Reduce the lower width with the KEY STONE ▼ button or the POINT DOWN button.

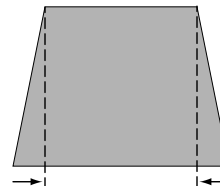

NO SHOW FUNCTION

Press the NO SHOW button on the Remote Control Unit to black out the image. This function is cancelled when the NO SHOW button is pressed again or any other function button is pressed.

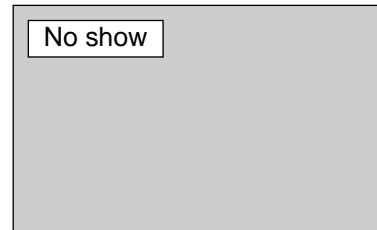

The message disappears after 4 seconds.

PICTURE FREEZE FUNCTION

Press the FREEZE button on the Remote Control Unit to freeze the picture on-screen. This function is cancelled when the FREEZE button is pressed again or any other function button is pressed.

P-TIMER FUNCTION

Press the P-TIMER button on the Remote Control unit. The timer display "00 : 00" appears on the screen and the timer starts to count the time (00 : 00 ~ 59 : 59).

To stop the P-TIMER, press the P-TIMER button. And then, press the P-TIMER button again to cancel the P-TIMER function.



SOUND ADJUSTMENT

SOUND VOLUME ADJUSTMENT

Press the VOLUME (+/-) button on the Remote Control Unit to adjust the volume. The Volume dialog box appears on the screen for a few seconds. The VOLUME (+) button increases the volume, and the VOLUME (-) button decreases the volume.

The sound volume can be adjusted through the ON-SCREEN MENU. (Refer to page 32.)

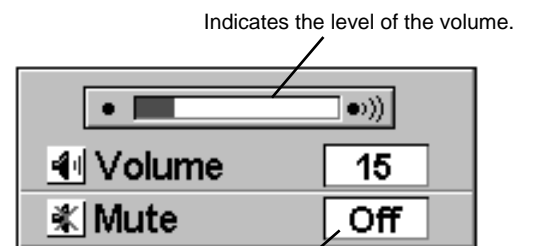

Press the MUTE button to turn the Mute function On or Off.

The display disappears after 4 seconds.

SOUND MUTE ADJUSTMENT

Press the MUTE button on the Remote Control Unit to mute the sound. To restore the sound to its previous level, press the MUTE button again or press the VOLUME (+/-) button.

The sound mute can be set through the ON-SCREEN MENU. (Refer to page 32.)

COMPUTER MODE

SELECTING COMPUTER MODE

DIRECT OPERATION

Select COMPUTER mode by pressing the MODE button on the Top Control or the COMPUTER button on the Remote Control Unit.

MENU OPERATION

Press the MENU button and the ON-SCREEN MENU will appear. Press the POINT LEFT/RIGHT buttons to select Computer  and press the SELECT button.

CURRENT MODE DISPLAY

When selecting the Computer Mode, the Current Mode display appears. It shows the information of the computer of the mode selected.

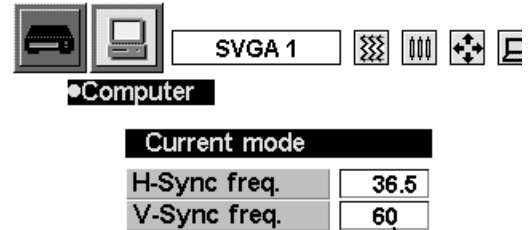
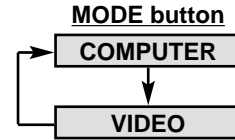

Providing the information of the computer detected by the projector.

SELECTING COMPUTER SYSTEM

AUTOMATIC MULTI-SCAN SYSTEM

This projector automatically tunes to most different types of computers based on VGA, SVGA, XGA or SXGA (refer to "COMPATIBLE COMPUTER SPECIFICATION" on page 23). When selecting Computer, this projector automatically tunes to the incoming signal and projects the proper image without any special settings. (Setting of the Computer System may be required when connecting some computers.)

Note : The projector may display one of the following messages.

Go to PC adj. The projector cannot discriminate or detect the input signal from the computer. Adjust and set the computer system manually. (Refer to page 24.)

No signal There is no signal input from the computer. Make sure the connection of the computer and the projector is set correctly. (Refer to TROUBLESHOOTING on page 37.)

SELECT COMPUTER SYSTEM MANUALLY

To set the Computer system manually, select the mode on the ON-SCREEN MENU.

- 1 Press the MENU button and the ON-SCREEN MENU will appear. Press the POINT LEFT/RIGHT buttons to select SYSTEM and press the SELECT button. Another dialog box COMPUTER SYSTEM Menu will appear.
- 2 Press the POINT DOWN button and a red-arrow icon will appear. Move the arrow to the system that you want to set, and then press SELECT button.

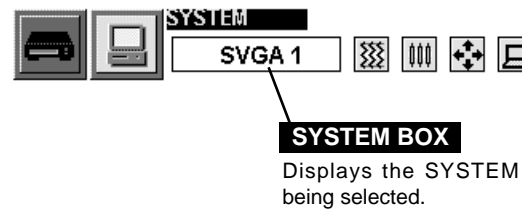

Displays the SYSTEM being selected.

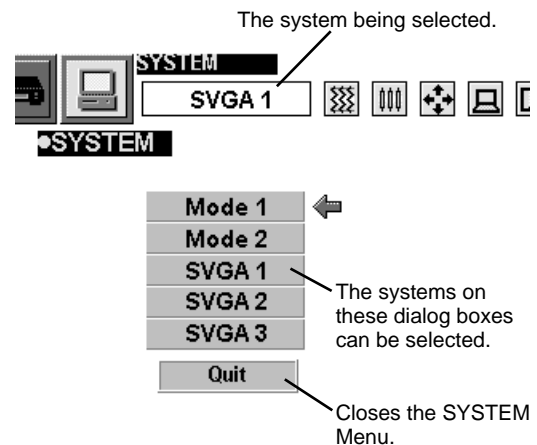

COMPATIBLE COMPUTER SPECIFICATIONS

Basically this projector can accept the signal from all computers with the V, H-Frequency below mentioned and less than 100 MHz of Dot Clock.

ON-SCREEN DISPLAY	RESOLUTION	H-Freq. (kHz)	V-Freq. (Hz)	ON-SCREEN DISPLAY	RESOLUTION	H-Freq. (kHz)	V-Freq. (Hz)
VGA 1	640 x 480	31.47	59.88	XGA 3	1024 x 768	60.023	75.03
VGA 2	720 x 400	31.47	70.09	XGA 4	1024 x 768	56.476	70.07
VGA 3	640 x 400	31.47	70.09	XGA 5	1024 x 768	60.31	74.92
VGA 4	640 x 480	37.86	74.38	XGA 6	1024 x 768	48.50	60.02
VGA 5	640 x 480	37.86	72.81	XGA 7	1024 x 768	44.00	54.58
VGA 6	640 x 480	37.50	75.00	XGA 8	1024 x 768	63.48	79.35
VGA 7	640 x 480	43.269	85.00	XGA 9	1024 x 768 (Interlace)	36.00	43.59
MAC LC13	640 x 480	34.97	66.60	XGA 10	1024 x 768	62.04	77.07
MAC 13	640 x 480	35.00	66.67	XGA 11	1024 x 768	61.00	75.70
RGB	—	15.734	30	XGA 12	1024 x 768 (Interlace)	35.522	43.48
RGB	—	15.625	25	XGA 13	1024 x 768	46.90	58.20
SVGA 1	800 x 600	35.156	56.25	XGA 14	1024 x 768	47.00	58.30
SVGA 2	800 x 600	37.88	60.32	XGA15	1024 x 768	58.03	72.00
SVGA 3	800 x 600	46.875	75.00	MAC 19	1024 x 768	60.24	75.08
SVGA 4	800 x 600	53.674	85.06	MAC 21	1152 x 870	68.68	75.06
SVGA 5	800 x 600	48.08	72.19	SXGA 1	1152 x 864	64.20	70.40
SVGA 6	800 x 600	37.90	61.03	SXGA 11	1152 x 900	61.20	65.20
SVGA 7	800 x 600	34.50	55.38	SXGA 13	1280 x 1024 (Interlace)	50.00	43.00
SVGA 8	800 x 600	38.00	60.51	SXGA 14	1280 x 1024 (Interlace)	50.00	47.00
SVGA 9	800 x 600	38.60	60.31	SXGA 17	1152 x 900	61.85	66.00
SVGA 10	800 x 600	32.70	51.09	SXGA 18	1280 x 1024 (Interlace)	46.43	43.35
SVGA 11	800 x 600	38.00	60.51	HDTV720p	—	45.00	60.00
MAC1 6	832 x 624	49.72	74.55	HDTV1035i	—	33.75	60.00
XGA 1	1024 x 768	48.36	60.00	HDTV1080i	—	33.75	60.00
XGA 2	1024 x 768	68.677	84.997				

NOTE : Specifications are subject to change without notice.

PC ADJUSTMENT

This Projector can automatically tune to the display signals from most personal computers currently distributed. However, some computers employ special signal formats which are different from the standard ones and may not be tuned by the Multi-Scan system of this projector. If this happens, the projector cannot reproduce a proper image and the image may be recognized as a flickering picture, a non-synchronized picture, a non-centered picture or a skewed picture.

This projector has a PC ADJUSTMENT function, to enable you to precisely adjust several parameters to match with those special signal formats. This projector has five independent memory areas to memorize those parameters manually adjusted. This enables you to recall the setting for a specific computer whenever you use it.

Note : This PC ADJUSTMENT function cannot be operated when "RGB," "HDTV1035i" or "HDTV1080i" is selected on the SYSTEM MENU (P22 and 23).

- 1 Press the MENU button and the ON-SCREEN MENU will appear. Press the POINT RIGHT/LEFT buttons to select PC ADJUST  and press the SELECT button. Another dialog box "Where to reserve" Menu will appear.
- 2 In this dialog box, you can store the parameter into the area from "Mode 1" to "Mode 5." When memorizing the new computer parameter, select the Mode with the message "Free" by pressing the POINT UP/DOWN buttons and the SELECT button. To change the parameters of the Mode previously set, select the Mode with "Stored."
- 3 When the Mode is selected, Parameter adjustment dialog box appears. Move the arrow to the item that you want to change by pressing the POINT UP/DOWN buttons, and adjust each item to match with your computer. To change the value, press either the POINT RIGHT / LEFT button.
Refer to the next page for adjusting each item.
- 4 Move the arrow to "Stored" and press the SELECT button. The parameter is memorized in the selected Mode.
- 5 To activate the Mode manually adjusted in this PC ADJUSTMENT Menu, select the Mode at the SYSTEM SELECT Menu. (Refer to page 22.)

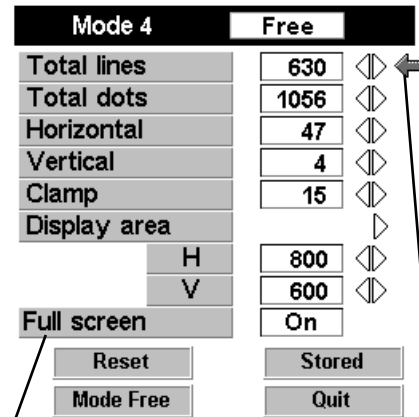
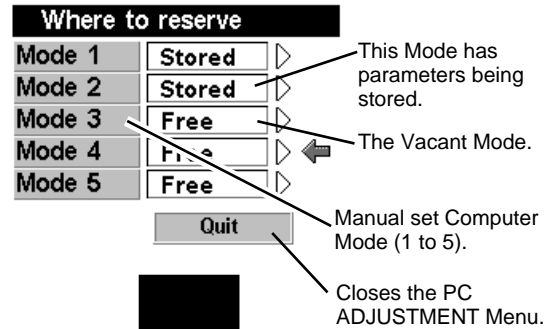

Total lines

The number of the total vertical lines. Adjust the number to match the image of your personal computer.

Total dots

The number of the total dots in one horizontal period. Adjust the number to match the image of your personal computer.

Horizontal / Vertical

Adjustment of the horizontal or vertical picture position. When the image is not centered on the screen, adjust each of those items.

Clamp

Adjustment of the clamp level. When the image has a dark bar(s), try this adjustment.

Display area

Adjustment of the area displayed with this projector. Select the resolution at the Display area dialog box, or adjust the number at the column of "H" or "V" to match the resolution of the image.

Full Screen

Set "On" to resize the image with 4 x 3 aspect ratio to fit the screen.

Each of the keys operates as follow.

- Reset** Recalls the parameter data that was previously adjusted.
- Mode free** Clears the parameter data previously set.
- Stored** Stores the parameters in the memory.
- Quit** Closes the PC ADJUST Menu.

The screenshot shows the PC ADJUST menu with the following settings:

Mode 4	Free
Total lines	630
Total dots	1056
Horizontal	47
Vertical	4
Clamp	15
Display area	
H	800
V	600
Full screen	On

Resolution list:

- 640x480
- 720x400
- 800x600
- 1024x768
- 1152x864
- 1280x1024

Buttons: Reset, Stored, Mode Free, Quit

PICTURE IMAGE ADJUSTMENTS

ADJUST PICTURE IMAGE MANUALLY

- 1 Press the MENU button and the ON-SCREEN MENU will appear. Press the POINT LEFT/RIGHT buttons to select IMAGE  and press the SELECT button. Another dialog box PICTURE IMAGE ADJUSTMENT Menu will appear.
- 2 Press the POINT DOWN button and a red-arrow icon will appear. Move the arrow to the item that you want to change by pressing the POINT UP/DOWN buttons. To change the value, press either the POINT RIGHT button or the POINT LEFT button.

Fine sync

Adjust the picture as necessary to eliminate flicker from the display. (From 0 to 255.)

Total dots

The number of the total dots in one horizontal period. Adjust the number to match your PC image.

White balance (Red / Green / Blue)

Move the arrow to the color that you want to adjust. Press POINT LEFT button to lighten the color and press POINT RIGHT button to deepen the color. (From 0 to 63.)

Contrast

Press POINT LEFT button to decrease contrast, and press POINT RIGHT button to increase contrast. (From 0 to 63.)

Brightness

Press POINT LEFT button to adjust the image darker, and press POINT RIGHT button to adjust brighter. (From 0 to 63.)

Gamma

Press either POINT LEFT button or POINT RIGHT button to obtain better balance of contrast. (From 0 to 16.)

Each of the keys operates as follow.

- Reset** Recalls the data previously adjusted.
- Stored** Stores the adjusted data in the memory.
- Quit** Closes the PICTURE IMAGE ADJUSTMENT Menu.

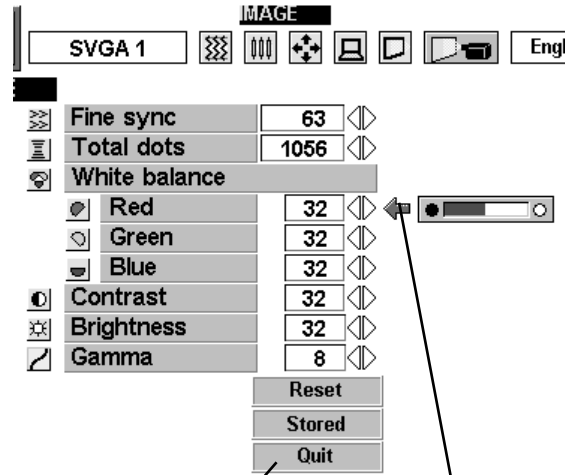

Closes the PICTURE IMAGE ADJUSTMENT Menu.

Move the arrow to the item and press POINT RIGHT / LEFT button.

NOTE : The Fine sync and the Total dots cannot be fully adjusted when "RGB," "HDTV1035i" or "HDTV1080i" is selected on the SYSTEM MENU (P22 and 23).

NORMAL FUNCTION

The normal picture level is preset on this projector at the factory and can be restored anytime you press the NORMAL button (located on the Top Control or on the Remote Control Unit). The "Normal" display will be displayed on the screen for a few seconds.

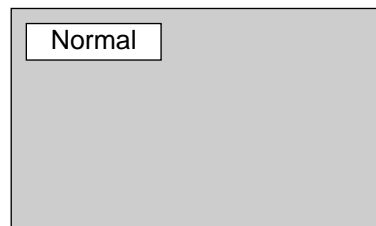

AUTO IMAGE FUNCTION

The Auto Image function is provided to automatically adjust Fine sync, Total dots, and Picture Position for most computers.

- 1 Press the MENU button and the ON-SCREEN MENU will appear. Press the POINT LEFT/RIGHT buttons to select AUTO IMAGE  and press the SELECT button. Another dialog box AUTO IMAGE Menu will appear.
- 2 Move the arrow to an item that you want to adjust by pressing the POINT UP/DOWN button. Change the setting On or Off by pressing the SELECT button.

Fine sync

Adjust the picture as necessary to eliminate flicker from the display. This item can be adjusted manually. (Refer to page 26.)

Total dots

The number of the total dots in one horizontal period. This item can be adjusted manually. (Refer to page 26.)

Position

Adjustment of the position of the image. This item can be adjusted manually. (Refer to page 27.)

- 3 Move the arrow to "Go!" and press the SELECT button to start the Auto Image function. This adjustment can be executed by pressing AUTO IMAGE button on the Remote Control Unit.

Stored Stores the On/Off setting of each item.

Go! Starts the Auto Image Function.

Quit Closes the AUTO IMAGE FUNCTION Menu.

NOTE : The Fine sync and the Total dots cannot be fully adjusted when "RGB," "HDTV1035i" or "HDTV1080i" is selected on the SYSTEM MENU (P22 and 23).

The Fine sync, Total dots, and Picture Position of some computers may not be fully adjusted with the Auto Image Function. In that case, manual adjustment is required to make fine image. (Refer to page 26 to adjust "Fine sync" or "Total dots" and page 27 to adjust Picture Position.)

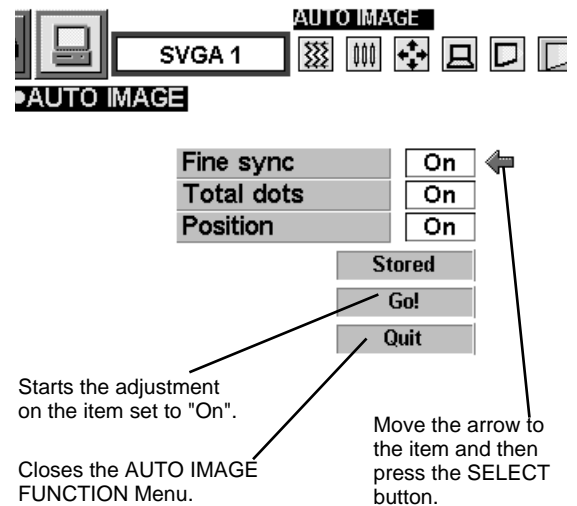

PICTURE POSITION ADJUSTMENT

The position of the image can be adjusted vertically and horizontally through PICTURE POSITION ADJUSTMENT.

- 1 Press the MENU button and the ON-SCREEN MENU will appear. Press the POINT LEFT/RIGHT buttons to select POSITION  and press the SELECT button. The PICTURE POSITION dialog box will appear.
- 2 Move the image by pressing the POINT UP / DOWN / RIGHT / LEFT buttons.
To cancel PICTURE POSITION ADJUSTMENT, press any button except POINT buttons. To return to the position previously set, press NORMAL button.

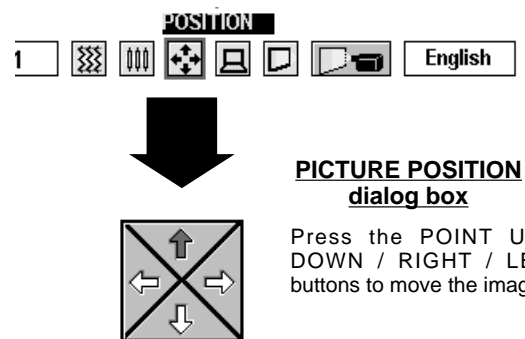

PICTURE SCREEN ADJUSTMENT

This projector has a picture screen resize function, which enables you to display the desirable image size.

- 1 Press the MENU button and the ON-SCREEN MENU will appear. Press the POINT LEFT/RIGHT buttons to select SCREEN  and press the SELECT button. Another dialog box PICTURE SCREEN Menu will appear.
- 2 Press the POINT DOWN button and a red-arrow icon will appear. Move the arrow to the function that you want to select and then press SELECT button.

True

To make the image into its original size select True in the dialog box. When the original image size is larger than the screen size (800 x 600), this projector enters Digital Zoom mode automatically.

Keystone

When the image is distorted vertically, select Keystone in the dialog box. The ON-SCREEN menu and SCREEN ADJUST menu disappears and the message "Keystone" is displayed. Correct the Keystone distortion by pressing the KEYSTONE ▲/▼ button or the POINT UP/DOWN button(s). Refer to KEYSTONE ADJUSTMENT on page 20.

Digital Zoom

To adjust the image size or pan the image, select Digital zoom in the dialog box. The ON-SCREEN menu and SCREEN ADJUST menu disappears and the message "D. Zoom" is displayed.

This projector also enters Digital Zoom mode by pressing the D.ZOOM ▲/▼ button on the Remote Control Unit. Refer to the following for operation.

Expand function

To expand the image size, press the D.ZOOM ▲ button or the SELECT button. The image is magnified by degrees.

Compress function

To compress the image size, press the D.ZOOM ▼ button or the RIGHT CLICK button. The size of image is reduced by degrees.

Panning function

To pan the image, press the POINT UP/DOWN/LEFT/RIGHT buttons. Panning function can work only when the image is larger than the screen size.

To cancel Digital Zoom mode, press any button except D.ZOOM ▲/▼, SELECT, RIGHT CLICK, or POINT button. To adjust the image to 800 x 600, press NORMAL button.

- This projector cannot display any resolution higher than 1280 X 1024. If your computer's screen resolution is higher than 1280 X 1024, reset the resolution to the lower before connecting the projector.
- The image data in other than SVGA (800 x 600) is modified to fit the screen size in the initial mode.
- The normal "Panning Operation" may not function properly if the computer system prepared with the "PC Adjust" is used.

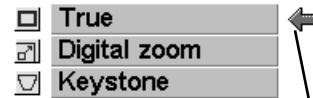
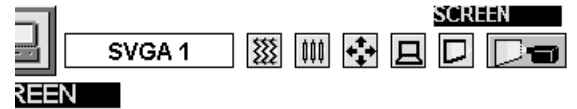

Move the arrow to the function and press the SELECT button.

NOTE : The True and the Digital Zoom cannot be operated when "RGB," "HDTV1035i" or "HDTV1080i" is selected on the SYSTEM MENU (P22 and 23).

VIDEO MODE

SELECTING VIDEO MODE

DIRECT OPERATION

Select VIDEO mode by pressing the MODE button on the Top Control or the VIDEO button on the Remote Control Unit.

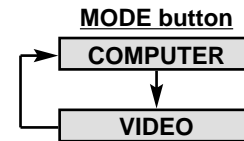

MENU OPERATION

Press the MENU button and the ON-SCREEN MENU will appear. Press the POINT LEFT/RIGHT buttons to select Video  and press the SELECT button.

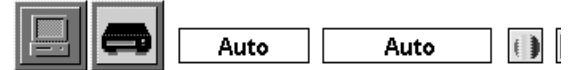

SELECTING VIDEO SOURCE

This projector automatically detects the signal from the VIDEO INPUT JACK(s) or the S-VIDEO INPUT JACK. When those jacks are connected at the same time, select the type of Video source in VIDEO SOURCE Menu.

- 1 Press the MENU button and the ON-SCREEN MENU will appear. Press the POINT LEFT/RIGHT buttons to select VIDEO SOURCE and press the SELECT button. Another dialog box VIDEO SOURCE Menu will appear.
- 2 Press the POINT DOWN button and a red-arrow icon will appear. Move the arrow to the source that you want to select, and then press the SELECT button.

Auto

The projector automatically detects the incoming Video source, and adjusts itself to optimize its performance.

- When both VIDEO jack and S-VIDEO jack are connected, the S-VIDEO jack has priority over the VIDEO jack.
- When both Y-Pb/Cb-Pr/Cr jacks and S-VIDEO jack are connected, the Y-Pb/Cb-Pr/Cr jacks have priority over the S-VIDEO jack.

Video / S-Video / Y, Pb/Cb, Pr/Cr

When the VIDEO INPUT JACK(s) and the S-VIDEO INPUT JACK are connected at the same time, or if the projector cannot choose the proper video source, it is necessary to select a specific video source among Video, S-Video and Y, Pb/Cb, Pr/Cr.

This box indicates the Video source being selected.

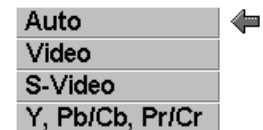

SELECTING COLOR SYSTEM

- 1 Press the MENU button and the ON-SCREEN MENU will appear. Press the POINT LEFT/RIGHT buttons to select SYSTEM and press the SELECT button. Another dialog box VIDEO SYSTEM Menu will appear.
- 2 Press the POINT DOWN button and a red-arrow icon will appear. Move the arrow to "Auto", and then press the SELECT button.

When the Video signal is from the VIDEO or the S-VIDEO JACK

Auto

The projector automatically detects the incoming Video system, and adjusts itself to optimize its performance. When the Video System is PAL-M or PAL-N, select the system manually.

PAL / SECAM / NTSC / NTSC.4.43 / PAL-M / PAL-N

If the projector cannot reproduce the proper video image, it is necessary to select a specific broadcast signal format among PAL, SECAM, NTSC, NTSC 4.43, PAL-M, and PAL-N.

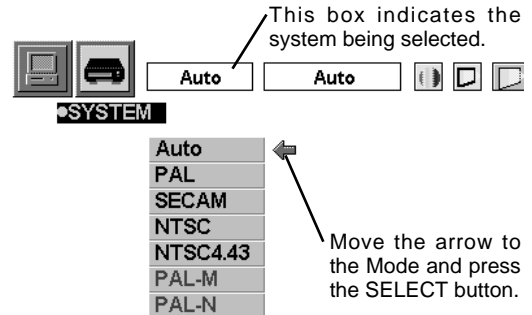

When the Video signal is from the Y, Pb/Cb, Pr/Cr JACKS

Auto

The projector automatically detects the incoming Video signal, and adjusts itself to optimize its performance.

COMPONENT VIDEO SIGNAL FORMAT

If the projector cannot reproduce the proper video image, it is necessary to select a specific component video signal format among 480i, 575i, 480p, 575p, 720p, 1035i and 1080i.

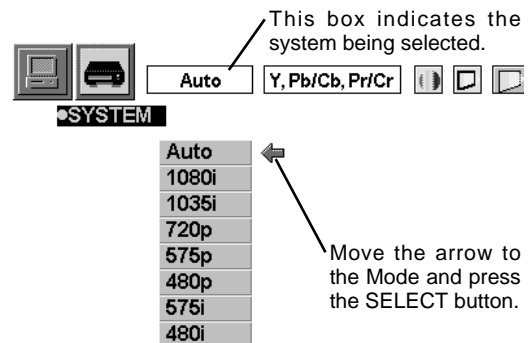

PICTURE SCREEN ADJUSTMENT

This projector has a picture screen resize function, which enables you to display the desirable image size.

- 1 Press the MENU button and the ON-SCREEN MENU will appear. Press the POINT LEFT/RIGHT buttons to select SCREEN and press the SELECT button. Another dialog box PICTURE SCREEN ADJUSTMENT DISPLAY will appear.
- 2 Press the POINT DOWN button and a red-arrow icon will appear. Move the arrow to the screen size that you want to set, and then press the SELECT button.

Regular

Normal Video Image size with 4 x 3 aspect ratio.

Wide

Resizes the image for wide screen size with 16 x 9 aspect ratio.

Keystone

When the image is distorted vertically, select Keystone in the dialog box. Correct the Keystone distortion by pressing KEYSTONE ▲/▼ button or POINT UP/DOWN button(s). Refer to KEYSTONE ADJUSTMENT on page 20.

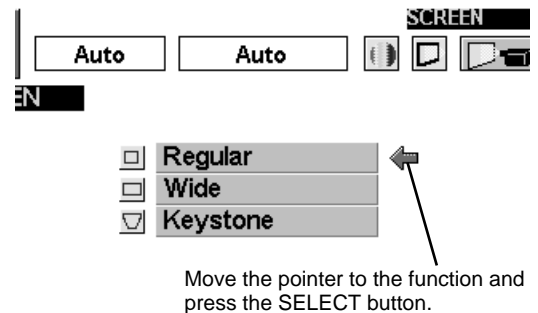

PICTURE IMAGE ADJUSTMENT

ADJUSTING THE PICTURE IMAGE

- 1 Press the MENU button and the ON-SCREEN MENU will appear. Press the POINT LEFT/RIGHT buttons to select IMAGE  and press the SELECT button. Another dialog box PICTURE IMAGE ADJUSTMENT Menu will appear.
- 2 Press the POINT DOWN button and a red-arrow icon will appear. Move the arrow to the item that you want to adjust by pressing the POINT UP/DOWN buttons. To change the value, press either the POINT RIGHT button or the POINT LEFT button.

Color

Press POINT LEFT button to lighten the image, and press POINT RIGHT button to deepen the image. (From 0 to 63.)

Tint

Press POINT LEFT button to increase purple, and press POINT RIGHT button to increase green. (From 0 to 63.)

White balance (Red / Green / Blue)

Move the arrow to the color that you want to adjust. Press POINT LEFT button to lighten the color, and press POINT RIGHT button to deepen the color. (From 0 to 63.)

Contrast

Press POINT LEFT button to decrease contrast, and press POINT RIGHT button to increase contrast. (From 0 to 63.)

Brightness

Press POINT LEFT button to darken the image, and press POINT RIGHT button to brighten the image. (From 0 to 63.)

Sharpness

Press POINT LEFT button to soften the image, and press POINT RIGHT button to sharpen the image. (From 0 to 15.)

Gamma

Press either POINT LEFT button or POINT RIGHT button to obtain better balance of contrast. (From 0 to 16.)

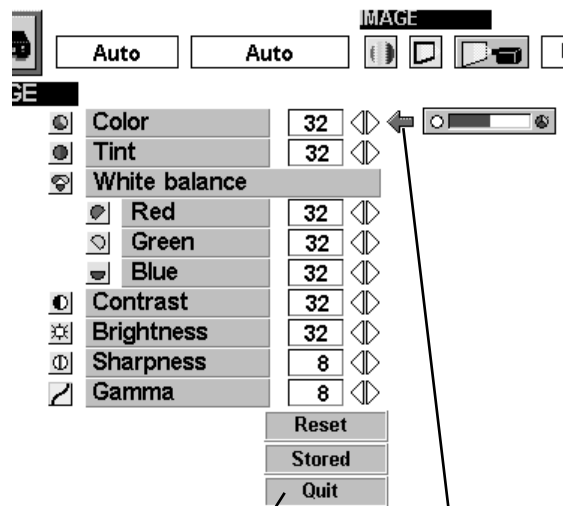

Closes the PICTURE IMAGE ADJUSTMENT Menu.

Move the arrow to the item and press POINT RIGHT / LEFT button.

Each of the keys operates as follow.

Reset Recalls the data previously adjusted.

Stored Stores the data in the memory.

Quit Closes the PICTURE IMAGE ADJUSTMENT Menu.

NORMAL FUNCTION

The normal picture level is preset on this projector at the factory and can be restored anytime you press the NORMAL button (located on the Top Control or on the Remote Control Unit). The "Normal" display will be displayed on the screen for a few seconds.

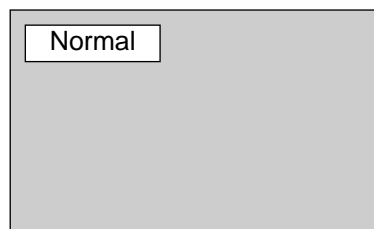

SETTING MENU

- 1 Press the MENU button and the ON-SCREEN MENU will appear. Press the POINT LEFT/RIGHT buttons to select SETTING  and press the SELECT button. Another dialog box SETTING Menu will appear.
- 2 Press the POINT DOWN button and a red-arrow icon will appear. Move the arrow to the item that you want to set, and then press the SELECT button to set it "On" or "Off" or press the POINT LEFT/RIGHT button to adjust the value.

Volume

Press POINT LEFT button to decrease volume, and press POINT RIGHT button to increase the volume. (From 0 to 63.)
The sound volume can be also adjusted by pressing the VOLUME (+/-) button on the remote control unit. (Refer to page 21)

Mute

Set "On" to mute the sound. To restore the sound, set "Off" or press the MUTE button or the VOLUME (+/-) button on the remote control unit.
The mute can be also set by pressing the MUTE button on the remote control unit. (Refer to page 21)

Blue back

When this function is "On," this projector will produce a blue image instead of the video noise on the screen when the input source is unplugged or turned off.

Display

This function decides whether to display the On-Screen Displays (except ON-SCREEN MENU).
Set "On1" to show all the On-Screen Displays.
Set "On2" to show the On-Screen Displays except the Preparation Display (Our Logo).
Set "Off" to set the On-Screen Displays below disappeared.

- Preparation Display (Our Logo and the Number-counting-down Display)
- Mode Display (Computer / Video)
- Volume/Mute Displays
- Normal Display
- No show Display
- Keystone Display
- True Display
- D.Zoom Display

Ceiling

When this function is "On," the top / bottom and the left / right reversed picture is provided to project the image from a ceiling mounted projector.

Rear

When this function is "On," the left / right reversed picture is provided to project the image to a rear projection screen.

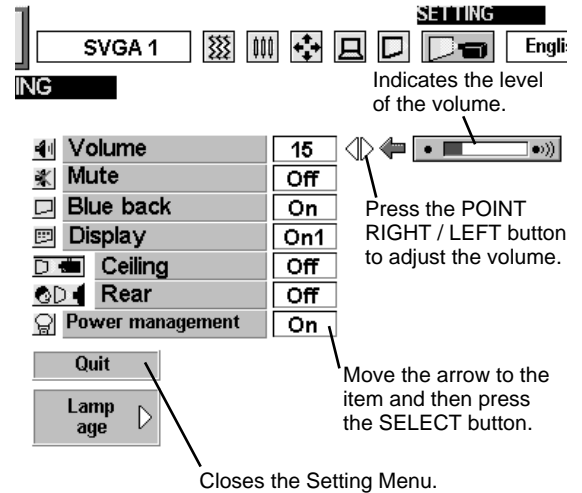

Ceiling function

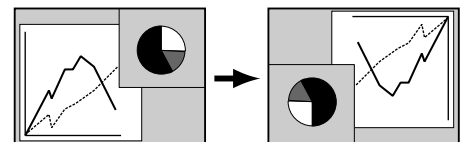

Rear function

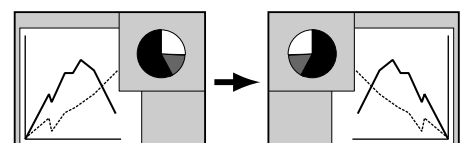

Power management

This function turns the Projection Lamp off when the projector detects signal interruption and the projector is not used for a certain period in order to reduce power consumption and maintain the Lamp-life. (This projector is shipped with this function ON.)

Power Management function operates to turn the Projection Lamp off when the input signal is interrupted and the projector is not operated over 5 minutes. This function operates as follows;

1. When the signal is interrupted, "No signal" and the counting down (5 minutes) display appears.
2. When the Projection Lamp turned off, the READY indicator turns off. The Cooling Fans operate for 90 seconds after the Projection Lamp is turned off. (During this "Cooling Down" period, the Lamp cannot be turned on.)
3. When the Lamp has cooled down, the READY indicator flashes and the Lamp can be turned on again (Power Management mode).

In this Power Management mode, the Projection Lamp is automatically turned on when the input signal connected or the projector is operated with any button on the Top Control or the Remote Control.



Time left until Lamp off.

Lamp age

The Lamp age function is designed to reset the lamp replacement monitor timer. When replacing the lamp, reset the lamp replacement monitor timer by using this function. (Refer to page 36.)

SELECTING LANGUAGE

The language used in the ON-SCREEN MENU is selectable from among English, German, French, Italian, Spanish and Japanese.

- 1 Press the MENU button and the ON-SCREEN MENU will appear. Press POINT LEFT/RIGHT buttons to select LANGUAGE and press the SELECT button. Another dialog box LANGUAGE Menu will appear.
- 2 Press the POINT DOWN button and a red-arrow icon will appear. Move the arrow to the language that you want to set, and then press the SELECT button.



Move the Pointer to the language that you want to set, and then press the SELECT button.

OPERATING WIRELESS MOUSE

The Wireless Remote Control Unit is not only able to operate the projector but also usable as a wireless mouse for most Personal Computers. The POINT buttons and the two CLICK buttons are used for the wireless mouse operation.

The wireless mouse is available only when PC mouse pointer is displayed on the screen. When the menu or the indicator of the projector is displayed on the screen instead of the PC mouse pointer, the wireless mouse cannot be used.

INSTALLATION

To use the Wireless Remote Control Unit as the Wireless Mouse for a Personal Computer, installation of the mouse driver (not supplied) is required. Make sure that the mouse driver is properly installed in your computer. And make sure that the mouse port of the computer connected to Control Port is activated.

- 1 Connect the mouse port of your computer to the Control Port of the projector with the Control Cable. (Refer to page 10 to 13 for connection.)
- 2 Turn the projector on first, and then turn on your computer. When the computer is switched on first, the Wireless Mouse may not work properly.

Note : When the computer has no mouse port, connect the Serial Port of the computer to Control Port of the projector with the Control Cable for Serial Port.

OPERATING WIRELESS MOUSE

When controlling the pointer of the computer, operate the Wireless Mouse with POINT button, SELECT button, and RIGHT CLICK button on the Wireless Remote Control Unit.

POINT button

Used to move the pointer. The pointer is moved corresponding with the direction you are pressing.

SELECT (LEFT CLICK) button

This button has the same function as the left button in a PC mouse.

RIGHT CLICK button

This button has the same function as the right button in a PC mouse. Pressing this button does not affect any operation when in Menu mode.

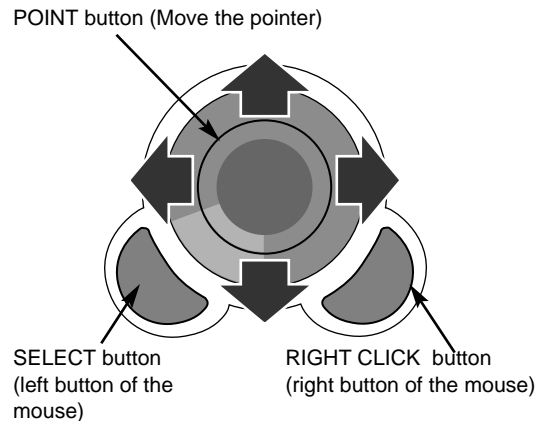

MAINTENANCE

TEMPERATURE WARNING INDICATOR

The TEMPERATURE WARNING Indicator flashes red when the internal temperature of the projector exceeds the normal temperature. The Indicator stops flashing when the temperature of the projector returns to normal. When the TEMPERATURE WARNING Indicator continues to flash, check the items listed below.

- 1 The Ventilation slots of the projector may be blocked. In such an event, reposition the projector so that the ventilation slots are not obstructed.
- 2 Air filters may be clogged with dust particles. Clean the air filters by following the section AIR FILTER CARE AND CLEANING below.
- 3 If the TEMPERATURE WARNING Indicator remains on after performing the above checks, the Cooling Fans or the Internal Circuits may be malfunctioning. Contact service personnel from an authorized dealer or service station.

AIR FILTER CARE AND CLEANING

The Removable Air Filters prevent dust from accumulating on the surface of the Projection Lens and the Projection Mirror. Should the Air Filters become clogged with dust particles, it will reduce the Cooling Fans' effectiveness and may result in internal heat build up and adversely affect the life of the projector. Clean the Air Filters following the steps below:

- 1 Turn the power off, and disconnect the AC power cord from the AC outlet.
- 2 Turn the projector upside down and remove two Air Filters (Large and Small) by pulling the latches upward.
- 3 Clean the Air Filters with brush or wash out the dust and particles.
- 4 Replace each Air Filter properly. Make sure that the Air Filters are fully inserted.



CAUTION

Do not operate the projector with the Air Filter removed. Dust may accumulate on the LCD Panel and the Mirror degrading picture quality.

Do not put small parts into the Air Intake Vents. It may result in malfunction of the projector.

The Air Filter is a small part. Ensure that children don't eat or swallow it.

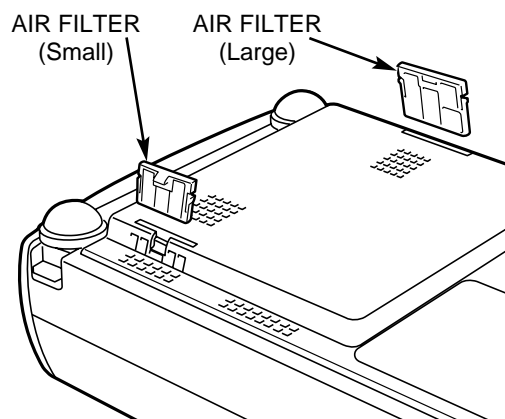

RECOMMENDATION

We recommend avoiding dusty/smoky environments when operating the projector. Usage in these environments may cause poor image quality.

When using under dusty or smoky conditions, dust may accumulate on the liquid crystal panel, lens, or optical elements inside it. This condition may degrade the quality of the projected image.

When the above symptoms are noticed, contact your authorized dealer or service station for proper cleaning.

CLEANING THE PROJECTION LENS

Follow these steps to clean the projection lens:

- 1 Apply a non-abrasive camera lens cleaner to a soft, dry cleaning cloth. Avoid using an excessive amount of cleaner. Abrasive cleaners, solvents or other harsh chemicals might scratch the lens.
- 2 Lightly wipe the cleaning cloth over the lens.
- 3 When the projector is not in use, replace the lens cover.

LAMP REPLACEMENT

When the life of the Lamp of this projector draws to an end, the LAMP REPLACEMENT indicator lights yellow. When the image becomes dark or the color of the image becomes unnatural, replacement of the Lamp is required.



CAUTION

- For continued safety, replace with a lamp assembly of the same type.
- Allow the projector to cool for at least 45 minutes before you open the lamp cover. The inside of the projector can become very hot.
- Do not drop the lamp assembly or touch the glass bulb! The glass can shatter and may cause injury.

Follow these steps to replace the lamp assembly.

- 1** Turn off the projector and disconnect the AC plug. Allow the projector to cool for at least 45 minutes.
- 2** Remove the screw with a screwdriver and remove the Lamp Cover.
- 3** Remove the two screws with a screwdriver and pull out the Lamp Assembly by grasping the handle.
- 4** Replace the Lamp Assembly with a new one and tighten the two screws. Make sure that the Lamp Assembly is set properly. Replace the Lamp Cover and tighten the screw.
- 5** Connect the AC Power Cord to the projector and turn the projector on.
- 6** Reset the Lamp Replacement Monitor Timer (refer to the section "Lamp Replacement Monitor Timer" below).

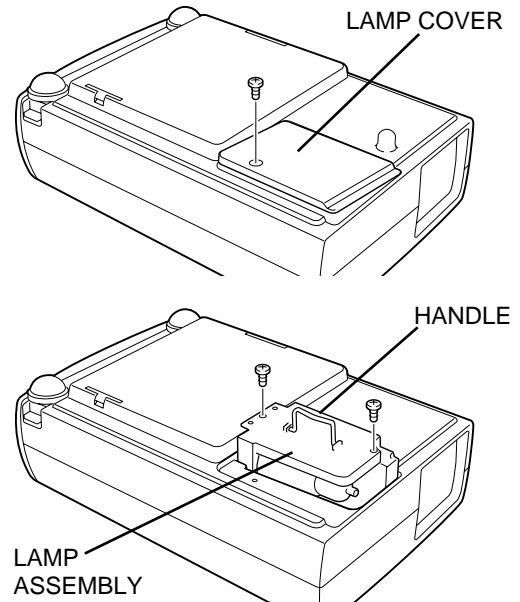

NOTE : Do not reset the LAMP REPLACEMENT MONITOR TIMER when the lamp is not replaced.

ORDER REPLACEMENT LAMP

Replacement Lamp can be ordered through your dealer. When ordering the Lamp, give the following information to the dealer.

- Model No. of your projector : PLC-SW10
- Replacement Lamp Type No. : POA-LMP23
(Service Parts No. 610 285 2912)

LAMP REPLACEMENT MONITOR TIMER

Be sure to reset the Lamp Replacement Monitor Timer when the Lamp Assembly is replaced. When the Lamp Replacement Monitor Timer is reset, the LAMP REPLACEMENT indicator stops lighting.

- 1** Turn the projector on, and press the MENU button and the ON-SCREEN MENU will appear. Press the POINT LEFT/RIGHT buttons to select SETTING and press the SELECT button (refer to the page 32, 33). Another dialog box SETTING MENU will appear.
- 2** Press the POINT DOWN button and a red-arrow icon will appear. Move the arrow to "Lamp age," and then press the SELECT button. The message "Lamp replace monitor Reset?" is displayed.
- 3** Select [Yes] to reset the Timer.

Do not reset the Lamp Replacement Monitor Timer, except after the lamp is replaced.

TROUBLESHOOTING

Before calling your dealer or service center for assistance, check the matters below once again.

1. Make sure you have connected the projector to your equipment as described in the section "CONNECTING THE PROJECTOR" on pages 11 ~ 13.
2. Check cable connection. Verify that all computer, video and power cords are properly connected.
3. Verify that all power is switched on.
4. If the projector still does not produce an image, re-start the computer.
5. If the image still does not appear, unplug the projector from the computer and check the computer monitor's display. The problem may be with your graphics controller rather than with the projector. (When you reconnect the projector, remember to turn the computer and monitor off before you power up the projector. Power the equipment back on in order of : Projector and computer.)
6. If the problem still exists, check the following chart.

Problem:	Try these Solutions
No power.	<ul style="list-style-type: none"> ● Plug the projector into the AC outlet. ● Be sure READY Indicator light is On. ● Wait 90 seconds after the projector is turned OFF before turning the projector back on. <p>NOTE : After pressing the power ON-OFF switch to OFF, make sure the projector works as follows:</p> <ol style="list-style-type: none"> 1. The LAMP indicator will light and the READY indicator will turn off. 2. After 90 seconds, the READY indicator will light green again and the projector may be turned on by pressing the power ON-OFF button. <ul style="list-style-type: none"> ● Check the TEMPERATURE WARNING indicator. If the indicator flashes red, the projector cannot be turned on. (See "TURNING ON/OFF THE PROJECTOR" section on page 19.) ● Check the Projection Lamp. (Refer to page 36.)
Image is out of focus.	<ul style="list-style-type: none"> ● Adjust the focus ● Make sure the projection screen is at least 4.6' (1.4m) from the projector. ● Check the projection lens to see if it needs cleaning. <p>NOTE : Moving the projector from a cool temperature location to a warm temperature location may result in moisture condensation on the lens. In such an event, leave the projector OFF and wait until condensation disappears.</p>
Picture is Left/Right reversed.	<ul style="list-style-type: none"> ● Check Ceiling / Rear feature. (See "SETTING" section on page 32.)
Picture is Top/Bottom reversed.	<ul style="list-style-type: none"> ● Check Ceiling feature. (See "SETTING" section on page 32.)
Some displays are not seen during the Operation.	<ul style="list-style-type: none"> ● Check Display feature.(See "SETTING" section on page 32.)
No image.	<ul style="list-style-type: none"> ● Check the connection between the computer or video equipment and the projector. ● When turning the projector on, it takes about 30 seconds to display the image. ● Check the system that you select is corresponding with the computer or the video equipment. ● Make sure the temperature is not out of the Operating Temperature (5°C ~ 35°C).
No sound.	<ul style="list-style-type: none"> ● Check audio cable connection from audio input source. ● Adjust the audio source. ● Press VOLUME (+) button. ● Press MUTE button.

Problem:	Try these Solution
Remote Control Unit does not work.	<ul style="list-style-type: none">● Check the batteries.● Check the ALL-OFF switch on the Remote Control Unit is set to "ON."● Make sure nothing is between the Remote Receiver and the Remote Control Unit.● Make sure you are not too far from the projector when using the Remote Control Unit. Maximum operating range is 16.4' (5m).
Wireless Mouse function does not work.	<ul style="list-style-type: none">● Check the cable connection between the projector and the computer.● Check the mouse setting on your computer.● Turn the projector on before you turn on the computer.

WARNING :
High voltages are used to operate this projector. Do not attempt to open the cabinet.

If the problem still persists after following all operating instructions, contact the sales dealer where you purchased the projector or the service center. Give the model number and explain the difficulty. We will advise you how to obtain service.



This symbol on the nameplate means the product is Listed by Underwriters Laboratories Inc. It is designed and manufactured to meet rigid U.L. safety standards against risk of fire, casualty and electrical hazards.

TECHNICAL SPECIFICATIONS

Projector Type	Multi-media Projector
Dimensions (W x H x D)	7.44" x 2.93" x 11.42" (189mm x 74.5mm x 290mm) (not including Adjustable Feet and Lens)
Net Weight	5.51 lbs (2.5 kg)
LCD Panel System	0.7" TFT Active Matrix type, 3 panels
Panel Resolution	800 x 600 dots
Number of Pixels	1,440,000 (800 x 600 x 3 panels)
Color System	PAL, SECAM, NTSC, NTSC4.43, PAL-M and PAL-N
High Definition TV Signals	480i, 480p, 575i, 575p, 720p, 1035i and 1080i
Scanning Frequency	H-sync. 15 ~ 80 KHz, V-sync. 50 ~ 100 Hz
Projection Image size (Diagonal)	Adjustable from 30" to 200"
Horizontal Resolution	500 TV lines
Projection Lens	F 2.0 ~ 2.3 lens with f 28 mm ~ 33.6 mm Manual zoom and focus
Throw Distance	4.6' ~ 26.3' (1.4 m ~ 8.0 m)
Projection Lamp	120 W
AV Input Jacks	RCA Type x 3 (Video/Y, Pb/Cb, Pr/Cr) and Mini DIN 4 pin x 1 (S-Video)
AV Audio Input Jack	Mini Jack (stereo)
Computer Input Jack	(VGA) HDB 15 Terminal x 1
Computer Audio Input Jack	Mini Jack (stereo)
Control Port Jack	Mini DIN 8 pin x 1
Audio Output Jack	Mini Jack (stereo)
Internal Audio Amp	1W RMS (Monaural)
Built-in Speaker	1 speaker, 1.57" x 1.18" (40mm x 30mm)
Feet Adjustment	0° to 7.6°
Voltage and Power Consumption	AC 100 ~ 120 V (2.2 A Max. Ampere), 50 / 60 Hz (The U.S.A and Canada) AC 200 ~ 240 V (1.1 A Max. Ampere), 50 / 60 Hz (Continental Europe and The U.K.)
Operating Temperature	41 °F ~ 95 °F (5 °C ~ 35 °C)
Storage Temperature	14 °F ~ 140 °F (-10 °C ~ 60 °C)
Remote Control Transmitter	Power Source : AA, UM3 or R06 Type x 2 Operating Range : 16.4' (5m) / ±30° Dimensions (W x H x D) : 2.2" x 1.3" x 7.6" (55mm x 34mm x 192mm) Net Weight : 0.35 lbs (160 g) (including batteries)
Accessories	Owner's Manual AC Power Cord Remote Control Transmitter and Batteries VGA Cable Control Cable for PS/2 port Carry Bag Lens Cover

- The specifications are subject to change without notice.

OPTIONAL PARTS

The parts listed below are optionally supplied. When ordering those parts, give the name and the Type No. of it to the sales dealer.

- Control Cable for Serial Port Type No. : POA-MCSRL
- Control Cable for ADB Port Type No. : POA-MCMAC
- MAC Adapter Type No. : POA-MACAP

