

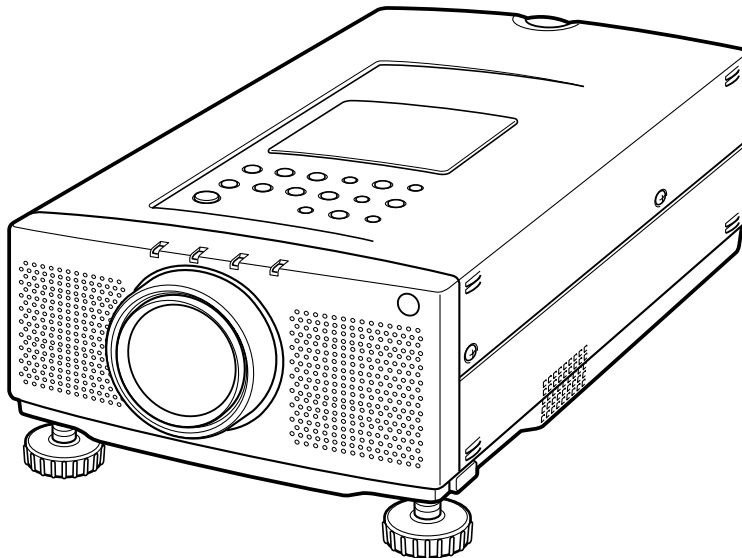

Multimedia Projector

**MODEL PLC-XP21E/XP18E
PLC-XP21/XP18**



OWNER'S INSTRUCTION MANUAL

TO THE OWNER

As the owner of a new Multi-media Projector, you are probably eager to try out your new projector. Before you do, we suggest that you spend a little time reading this manual to familiarize yourself with the operating procedures, so that you will receive maximum satisfaction from the many features included in your new projector.

This owner's manual will acquaint you with your projector's features. Reading it will help us too. Through the years, we have found that many service requests were not caused by problems with our projectors. They were caused by problems that could have been prevented, if the owner had followed the instructions in the manual.

You can often correct operating problems yourself. If your projector fails to work properly, see "TROUBLESHOOTING" section on pages 51 ~ 52 and try the solutions marked for each problem.

SAFETY PRECAUTIONS

WARNING:

TO REDUCE THE RISK OF FIRE OR ELECTRIC SHOCK, DO NOT EXPOSE THIS APPLIANCE TO RAIN OR MOISTURE.

This projector produces intense light from the projection lens. Do not stare directly into the lens as possible eye damage could result. Be especially careful that children do not stare directly into the beam.

The Remote Control Unit, supplied to this projector, emits the laser beam as the Laser Pointer function from the Laser Light Window while pressing the LASER button (for 1 minute). Do not look into the Laser Light Window or shine the laser beam on yourself or other people. Eye damage may result.

This projector should be set in the way indicated. If not, it may result in fire hazard.

If the Projector will not be used for an extended time, unplug the new Projector from the power outlet.

READ AND KEEP THIS OWNER'S MANUAL FOR LATER USE.

IMPORTANT:

For your protection in the event of theft or loss of this LCD projector, please record the Model Number and Serial Number located on the rear of unit and retain this information. Refer to these numbers whenever you call upon your authorized dealer regarding this product.

Model No : _____

Serial No : _____

Do not discard shipping carton and packing materials.

These items may be needed for storage or future servicing.

IMPORTANT SAFETY INSTRUCTIONS

All the safety and operating instructions should be read before the product is operated.

Read all of the instructions given here and retain them for later use. Unplug this projector from AC power supply before cleaning. Do not use liquid or aerosol cleaners. Use a damp cloth for cleaning.

Do not use attachments not recommended by the manufacturer as they may cause hazards.

Do not place this projector on an unstable cart, stand, or table. The projector may fall, causing serious injury to a child or adult, and serious damage to the projector. Use only with a cart or stand recommended by the manufacturer, or sold with the projector. Wall or shelf mounting should follow the manufacturer's instructions, and should use a mounting kit approved by the manufacturer.

Do not expose this unit to rain or use near water... for example, in a wet basement, near a swimming pool, etc...

Slots and openings in the back and bottom of the cabinet are provided for ventilation, to insure reliable operation of the equipment and to protect it from overheating.

The openings should never be covered with cloth or other material, and the bottom opening should not be blocked by placing the projector on a bed, sofa, rug, or other similar surface. This projector should never be placed near or over a radiator or heat register.

This projector should not be placed in a built-in installation such as a bookcase unless proper ventilation is provided.

This projector should be operated only from the type of power source indicated on the marking label. If you are not sure of the type of power supplied, consult your authorized dealer or local power company.

Do not overload wall outlets and extension cords as this can result in fire or electric shock. Do not allow anything to rest on the power cord. Do not locate this projector where the cord may be damaged by persons walking on it.

Never push objects of any kind into this projector through cabinet slots as they may touch dangerous voltage points or short out parts that could result in a fire or electric shock. Never spill liquid of any kind on the projector.

Do not attempt to service this projector yourself as opening or removing covers may expose you to dangerous voltage or other hazards. Refer all servicing to qualified service personnel.

Unplug this projector from wall outlet and refer servicing to qualified service personnel under the following conditions:

- When the power cord or plug is damaged or frayed.
- If liquid has been spilled into the projector.
- If the projector has been exposed to rain or water.
- If the projector does not operate normally by following the operating instructions. Adjust only those controls that are covered by the operating instructions as improper adjustment of other controls may result in damage and will often require extensive work by a qualified technician to restore the projector to normal operation.
- If the projector has been dropped or the cabinet has been damaged.
- When the projector exhibits a distinct change in performance-this indicates a need for service.

When replacement parts are required, be sure the service technician has used replacement parts specified by the manufacturer that have the same characteristics as the original part. Unauthorized substitutions may result in fire, electric shock, or injury to persons.

Upon completion of any service or repairs to this projector, ask the service technician to perform routine safety checks to determine that the projector is in safe operating condition.

Follow all warnings and instructions marked on the projectors.

For added protection to the projector during a lightning storm, or when it is left unattended and unused for long periods of time, unplug it from the wall outlet. This will prevent damage due to lightning and powerline surges.



An appliance and cart combination should be moved with care. Quick stops, excessive force, and uneven surfaces may cause the appliance and cart combination to overturn.

If the projector is to be built into a compartment or similarly enclosed, the minimum distances must be maintained.

Do not cover the ventilation slot on the projector.

Heat build-up can reduce the service life of your projector, and can also be dangerous.

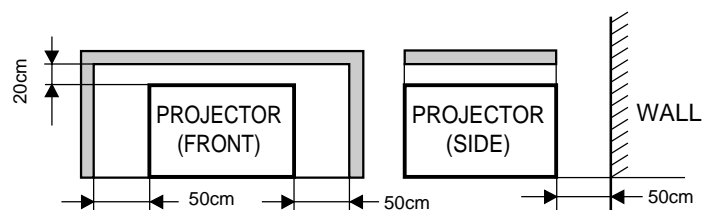

TABLE OF CONTENTS

	PAGE		PAGE
FEATURES AND DESIGN	5	MENU OPERATION	30-31
COMPATIBILITY	5	MODE SELECT	30
IMAGE RESOLUTION	5	SOUND ADJUSTMENT	31
AUTOMATIC MULTISCANNING SYSTEM	5	LANGUAGE ADJUSTMENT	31
MULTILANGUAGE MENU DISPLAY	5	VIDEO MODE	32-35
LASER POINTER FUNCTION	5	COLOUR SYSTEM SELECT	32
OTHER FEATURES	5	VIDEO SOURCE SELECT	33
UNPACKING THE PROJECTOR	5	PICTURE IMAGE ADJUSTMENT	34
TRADEMARKS	5	PICTURE SCREEN ADJUSTMENT	35
INSTALLATION	6-9	COMPUTER MODE	36-48
NAME OF EACH PART OF THE PROJECTOR	6	COMPUTER SYSTEM SELECT	36
SETTING-UP THE PROJECTOR	7	COMPATIBLE COMPUTER SPECIFICATIONS	37
MOVING THE PROJECTOR	8	AUTO IMAGE FUNCTION	38
POWER REQUIREMENTS	9	PICTURE IMAGE ADJUSTMENT	39
CONNECTING THE PROJECTOR	10-18	PICTURE POSITION ADJUSTMENT	40
TERMINAL OF THE PROJECTOR	10	PC ADJUSTMENT	41-44
CONNECTING THE COMPUTER	11-15	PICTURE SCREEN ADJUSTMENT	45
CONNECTING THE VIDEO EQUIPMENT	16-18	OTHER FUNCTION SETTING	46-48
BEFORE OPERATION	19-26	BLUE BACK	46-47
CONTROLS AND INDICATORS	19-20	DISPLAY	46-47
OPERATION OF THE REMOTE CONTROL	21-23	CEILING	46-47
CONTROL THE PROJECTOR	24-26	REAR	46-47
DIRECT OPERATION	24	SPLIT WIPE	46-47
MENU OPERATION	25-26	POWER MANAGEMENT	46-47
BASIC OPERATION	27-31	REMOTE CONTROL (Mode 1 or Mode 2)	46-47
TURNING ON/OFF THE PROJECTOR	27	LAMP AGE	48
DIRECT OPERATION	27-29	APPENDIX	49-53
MODE SELECT	27	MAINTENANCE	49-51
SOUND VOLUME ADJUSTMENT	28	TEMPERATURE WARNING INDICATOR	49
SOUND MUTE FUNCTION	28	AIR FILTER CARE AND CLEANING	49
ZOOM ADJUSTMENT	28	LAMP REPLACEMENT	50
FOCUS ADJUSTMENT	28	CLEANING THE LENS	51
DIGITAL ZOOM FUNCTION	28	TROUBLESHOOTING	51-52
KEystone FUNCTION	28	TECHNICAL SPECIFICATIONS	53
NO SHOW FUNCTION	29		
FREEZE PICTURE FUNCTION	29		
AUTO IMAGE FUNCTION	29		
NORMAL PICTURE FUNCTION	29		
P-TIMER FUNCTION	29		

FEATURES AND DESIGN

The projector is a multimedia projector that combines powerful and sophisticated features with easy-to-use, intuitive controls. Built-in multimedia features include audio, a palette of 16.77 million colours and active matrix liquid crystal display (LCD) technology. The projector is ideal for high-performance business, training and imaging applications that demand exceptional colour quality.

COMPATIBILITY

The projector is compatible with many different types of personal computers and video devices, including:

- IBM-compatible computers, including laptops, up to 1280 x 1024 resolution.
- Apple Macintosh and PowerBook computers up to 1280 x 1024 resolution.
- Various VCRs, video disc players, video cameras, DVD players, satellite TV tuners or other AV equipment using any of the worldwide video standards, including NTSC, NTSC4.43, PAL, PAL-M, PAL-N and SECAM.

IMAGE RESOLUTION

The resolution of the projector's projected image is 1024 x 768. The projector displays computer images just as they appear on your computer's monitor. Screen resolutions between 1024 x 768 and 1280 x 1024 are compressed to 1024 x 768. The projector cannot display screen resolutions above 1280 x 1024. If your computer's screen resolution is higher than 1280 x 1024, reset it to a lower resolution before you connect the projector.

AUTOMATIC MULTISCANNING SYSTEM

This projector can detect display signals from most personal computers currently distributed. It is free from complicated adjustments to project picture images from PC.

MULTILANGUAGE MENU DISPLAY

MENU DISPLAY is displayed with ; English, German, French, Italian, Spanish and Japanese.

LASER POINTER FUNCTION

The Remote Control Unit of this projector includes the Laser Pointer function providing the ability to point and highlight during presentations.

OTHER FEATURES

This projector has Motor Zoom/Focus, No Show, Picture Freeze, Keystone, Mute Functions.

UNPACKING THE PROJECTOR

The projector comes with the parts listed below. Check to find all the parts are included. If any parts are missing, contact an authorized dealer or service station.

- Owner's Manual.
- AC Power Cord.
- Remote Control Unit.
- Batteries for Remote Control Units.
- VGA Cable.
- Mouse Cable for PS/2 port.
- Mouse Cable for serial port.
- Mouse Cable for ADB port.
- VGA/MAC Adapter.
- Protective Dust Cover.
- Lens Cover.

TRADEMARKS

- Apple, Macintosh, and PowerBook are trademarks or registered trademarks of Apple Computer, Inc.
- IBM and PS/2 are trademarks or registered trademarks of International Business Machines, Inc.
- Windows is a trademarks or registered trademarks of Microsoft Corporation.
- Other trademarks are the property of their respective owners

INSTALLATION

NAME OF EACH PART OF THE PROJECTOR

FRONT OF THE PROJECTOR

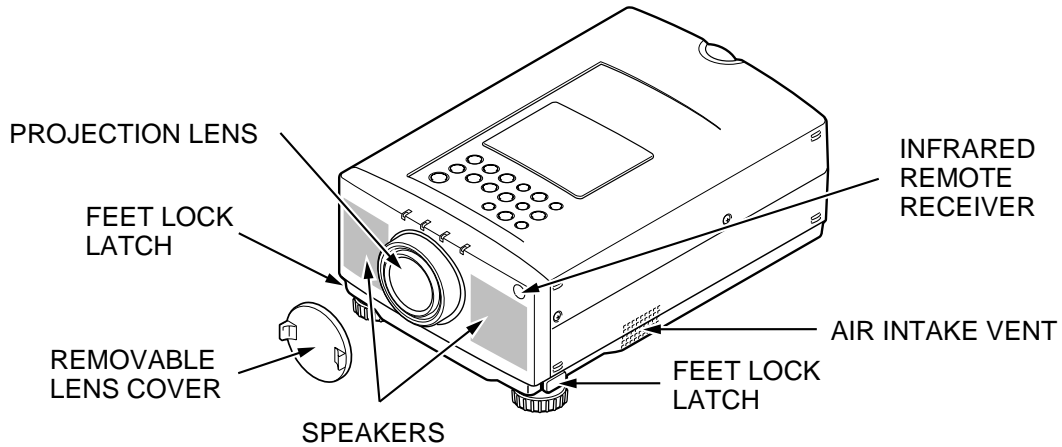

REAR OF THE PROJECTOR

EXHAUST VENT



CAUTION HOT AIR!

Air blown from the exhaust vent is hot.

Observe the following when handling your projector or choosing a location to install it.

- Keep heat-sensitive objects away from the exhaust port.
- If you set the projector on top of a metallic surface, the surface will become hot because of the hot air exhaust. Be careful when handling.
- Do not touch the cabinet near to the exhaust vent area, and especially screws and metallic parts. These parts will become hot while the projector is used.

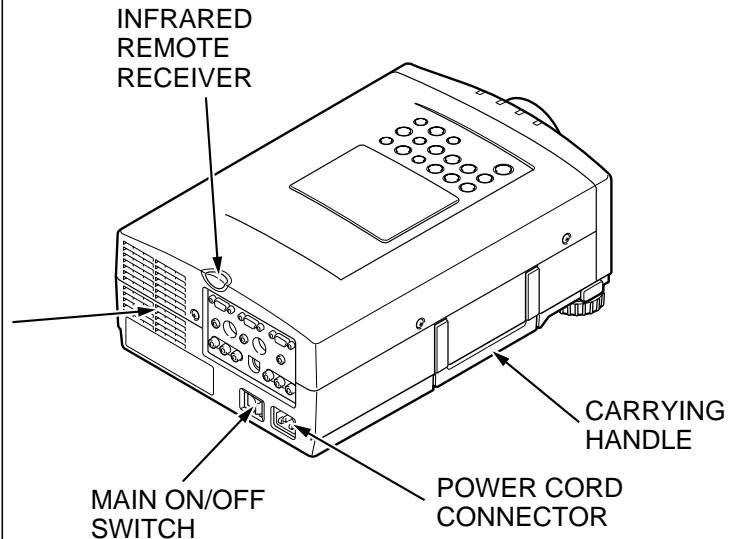

BOTTOM OF THE PROJECTOR

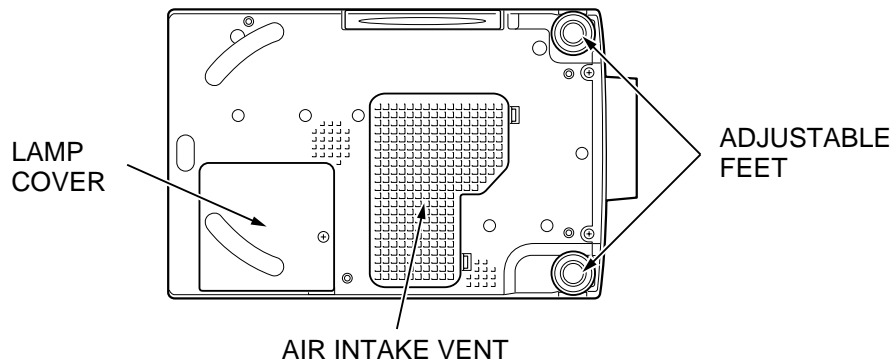

SETTING-UP THE PROJECTOR

POSITIONING:

- This projector is basically designed to project on a flat projection surface.
- This projector can be focused from 1.4 m ~ 14.4 m.
- Refer to the figure below as an example when positioning the projector to the screen.

ROOM LIGHT

The level of brightness in a room has a great influence on picture quality. It is recommended to limit ambient lighting in order to provide the best image.

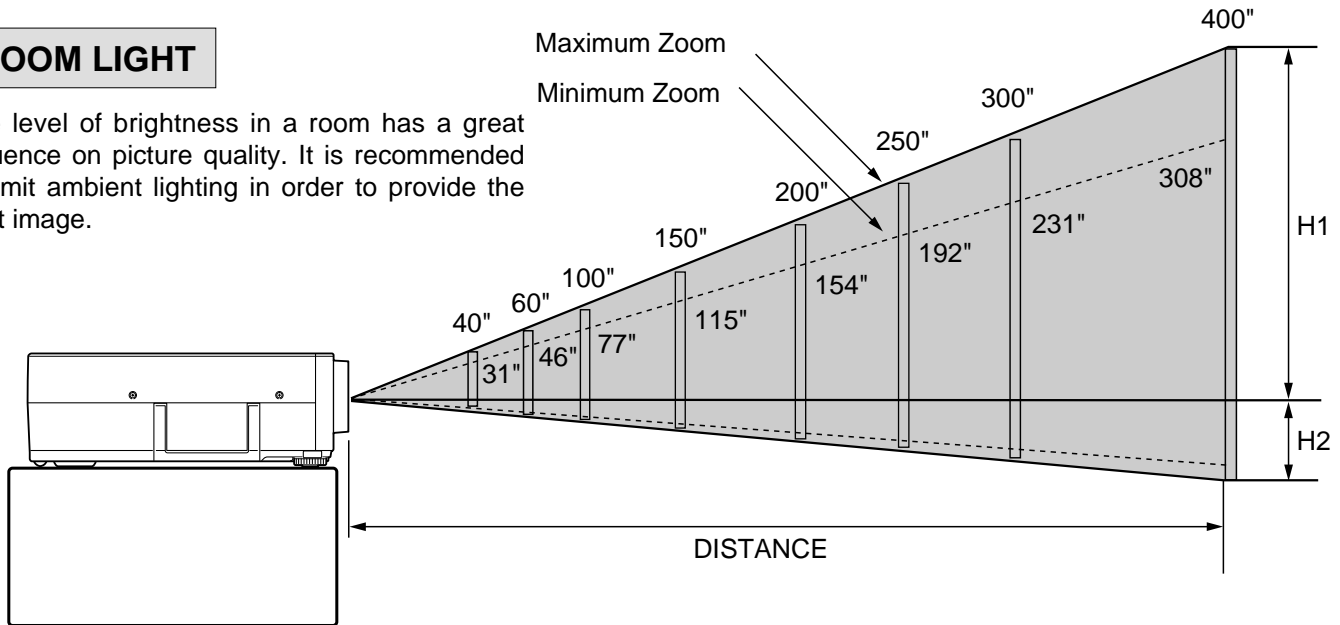

Screen Size	Max. Zoom	40"	60"	100"	150"	200"	250"	300"	400"
	Min. Zoom	31"	46"	77"	115"	154"	192"	231"	308"
Distance		1.4m	2.2m	3.6m	5.4m	7.2m	9.0m	10.8m	14.4m

Screen Size (W x H) mm	40"	60"	100"	150"	200"	250"	300"	400"
	813 x 610	1219 x 914	2032 x 1524	3048 x 2286	4064 x 3048	5080 x 3810	6096 x 4572	8128 x 6096
Height (H1)	581 mm	870 mm	1451 mm	2177 mm	2903 mm	3629 mm	4354 mm	5806 mm
Height (H2)	29 mm	44 mm	73 mm	109 mm	145 mm	181 mm	218 mm	290 mm

VENTILATION

This projector is equipped with cooling fan to protect it from overheating. Pay attention to the following to ensure proper ventilation and avoid a possible risk of fire and malfunction.



- Do not cover the vents with papers or other materials.
- Keep the rear grill at least 1 m away from any object.
- Make sure that there are no objects under the projector. An object under the projector may prevent the projector from taking the cooling air through the bottom vent.

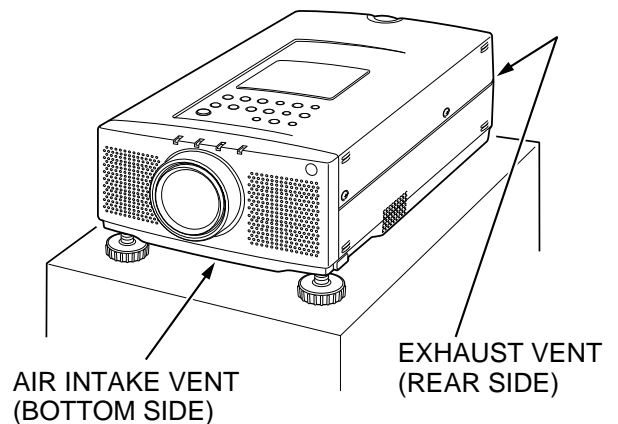

INSTALLATION

ADJUSTABLE FEET

Picture tilt and projection angle can be adjusted by rotating the ADJUSTABLE FEET. Projection angle can be adjusted 0 to 6°.

1. Lift the front of the projector and press the FEET LOCK LATCHES on both sides of the projector.
2. Release the FEET LOCK LATCHES to lock the ADJUSTABLE FEET and rotate the ADJUSTABLE FEET to fine tune the position and the tilt.
3. To shorten the ADJUSTABLE FEET, lift the front of the projector and press and undo the FEET LOCK LATCHES.

NOTE: The position and the keystone distortion of the image can also be adjusted using the KEYSTONE function. (See pages 28, 35 and 45).

FEET LOCK BUTTONS

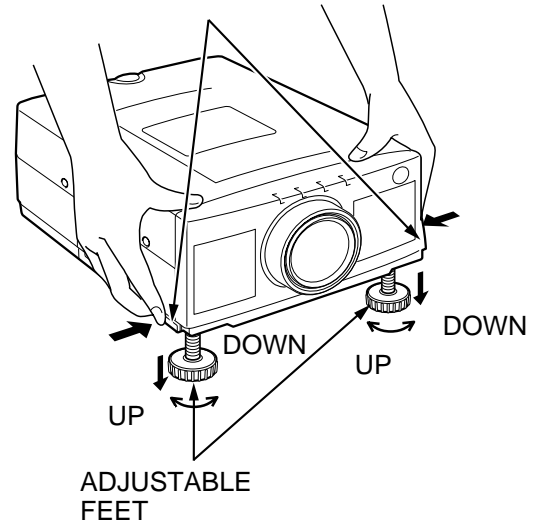

MOVING THE PROJECTOR



Use the carrying handle when moving the projector. Replace the lens cover and retract the adjustable feet when moving the projector to prevent damage to the projector.

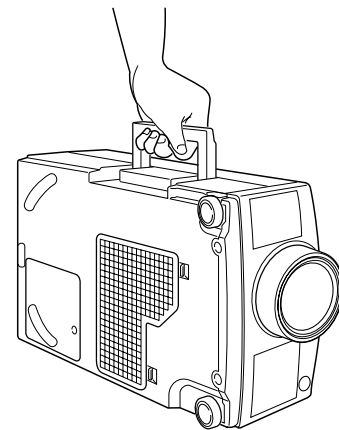

CAUTION IN CARRYING OR TRANSPORTING THE PROJECTOR

- Do not drop or bump the projector, otherwise damages or malfunctions may result.
- When transporting the projector, use a Sanyo recommended Carrying Case.
- Do not transport the projector by using a courier or transport service in an unsuitable transport case. This may cause damage to the projector. To transport the projector through a courier or transport service, use a Sanyo recommended Case.
- For a carrying or transportation cases, contact a Sanyo authorized dealer.

POWER REQUIREMENTS

MODEL PLC-XP21E/XP18E

Your projector uses nominal input voltages of 200-240 VAC. The projector automatically selects the correct input voltage. The projector is designed to work with single-phase power systems having a grounded neutral conductor. To reduce the risk of electrical shock, do not plug into any other type of power system. Consult your authorized dealer or service station if you are not sure what type of power is supplied to your building.

MODEL PLC-XP21/XP18

Your projector uses nominal input voltages of 110-120 VAC. The projector automatically selects the correct input voltage. The projector is designed to work with single-phase power systems having a grounded neutral conductor. To reduce the risk of electrical shock, do not plug into any other type of power system. Consult your authorized dealer or service station if you are not sure what type of power is supplied to your building.

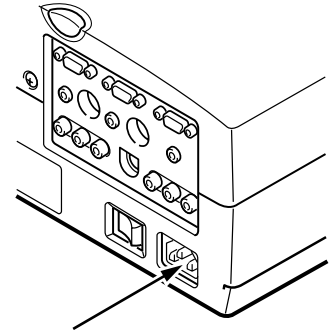

Connect the AC power supply cord (supplied) to the projector. The socket-outlet must be near this equipment and must be easily accessible.

CONNECTING THE PROJECTOR

TERMINAL OF THE PROJECTOR

REAR OF THE PROJECTOR

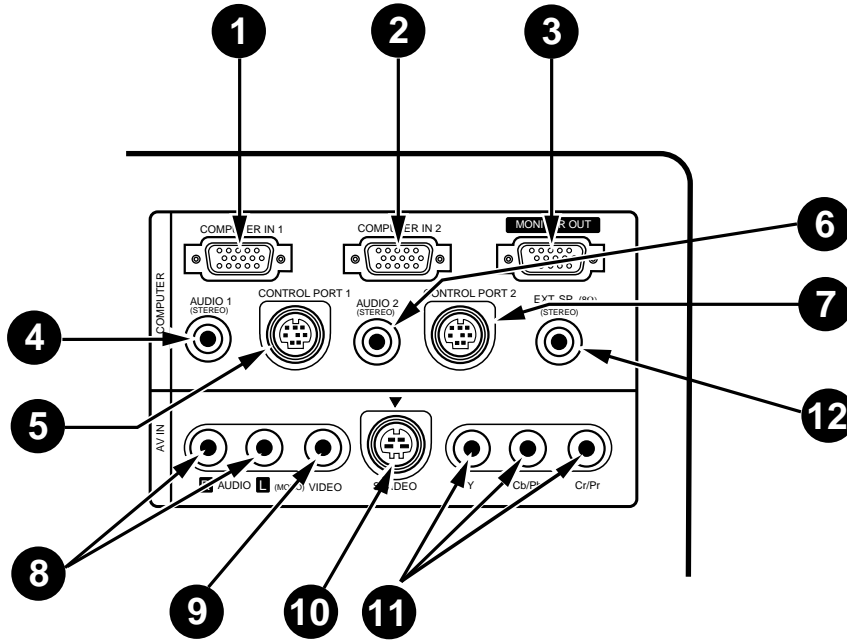

- 1 COMPUTER INPUT-1 TERMINAL**
Used to connect a computer to the projector.
- 2 COMPUTER INPUT-2 TERMINAL**
Used to connect a computer to the projector.
- 3 MONITOR OUTPUT TERMINAL**
Used to connect a monitor to the projector.
- 4 COMPUTER AUDIO INPUT-1 JACK**
mini stereo type
Used to connect a computer audio input to the projector.
- 5 CONTROL PORT-1 CONNECTOR**
Used to connect a mouse cable to the projector.
- 6 COMPUTER AUDIO INPUT-2 JACK**
mini stereo type
Used to connect a computer audio input to the projector.
- 7 CONTROL PORT-2 CONNECTOR**
Used to connect a mouse cable to the projector.
NOTE: Control port-2 connector can be also used as serial port (RS-232C).
- 8 AUDIO INPUT JACKS**
Used to connect an audio input to the projector.
- 9 VIDEO INPUT JACK**
Used to connect a video source to the projector.
- 10 S-VIDEO INPUT JACK**
Used to connect a S-VHS video source to the projector.
- 11 COMPONENT VIDEO INPUT JACKS**
Used to connect a component video source to the projector.
- 12 EXT. SP. JACK (3.5 mm mini stereo type)**
Used to connect an external speaker system.

CONNECTING THE COMPUTER

CONNECTING TO THE COMPUTER INPUT TERMINALS (1 and 2)

Personal computers can be connected to the HDB15-pin (VGA) terminal on the projector.

- Connect the computer to these terminals using the VGA cable and VGA/Macintosh adapter (provided).

CAUTION: For projectors, the VGA cable provided is designed to reduce RFI (Radio Frequency Interference) emissions. For regulatory compliance reasons, this cable must be used and must not be replaced by any other cable.

CONNECTING TO THE MONITOR OUTPUT TERMINAL

This terminal outputs the information of the selected computer source being viewed on the screen (Computer 1 or Computer 2). When video source is selected, this terminal outputs Computer 1 input information.

An external monitor can be connected to the HDB15-pin (VGA) terminal on the projector.

- Connect the monitor to this terminal using the VGA cable (not provided).

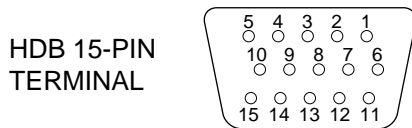

Pin No./Signal

- 1 Red input
- 2 Green input
- 3 Blue input
- 4 Sense 2
- 5 Ground (Horiz.sync.)
- 6 Ground (Red)
- 7 Ground (Green)
- 8 Ground (Blue)

Pin No./Signal

- 9 Non Connect
- 10 Ground (Vert. sync.)
- 11 Sense 0
- 12 Sense 1
- 13 Horiz. sync
- 14 Vert. sync
- 15 Reserved

CONNECTING TO THE COMPUTER AUDIO INPUT JACKS (1 and 2)

- Connect audio outputs from your computer to these jacks using the audio cable (not provided).

CONNECTING TO THE CONTROL PORT (DIN 8 PIN) CONNECTORS (1 and 2)

- If you wish to control the computer with projector's remote control unit, you must connect control port (PS/2, Serial or ADB port) on your computer to projector's control port with cable. (three type cables supplied; for PS/2 Port, Serial Port and ADB Port).

■ CONTROL PORT

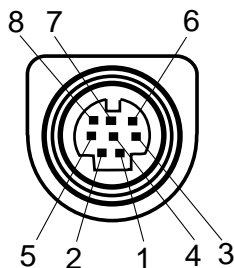

	PS/2 Port	Serial Port	ADB Port
1	————	RXD	————
2	CLK	————	ADB
3	DATA	————	————
4	GND	GND	GND
5	————	RTSCTS	————
6	————	TXD	————
7	GND	GND	————
8	————	GND	GND

NOTE: The RXD port (1 pin on the Serial Port) is provided on control port 2 connector only. If you control the projector by computer, you must connect control port 2 connector.

CONNECTING AN IBM-COMPATIBLE DESKTOP COMPUTER

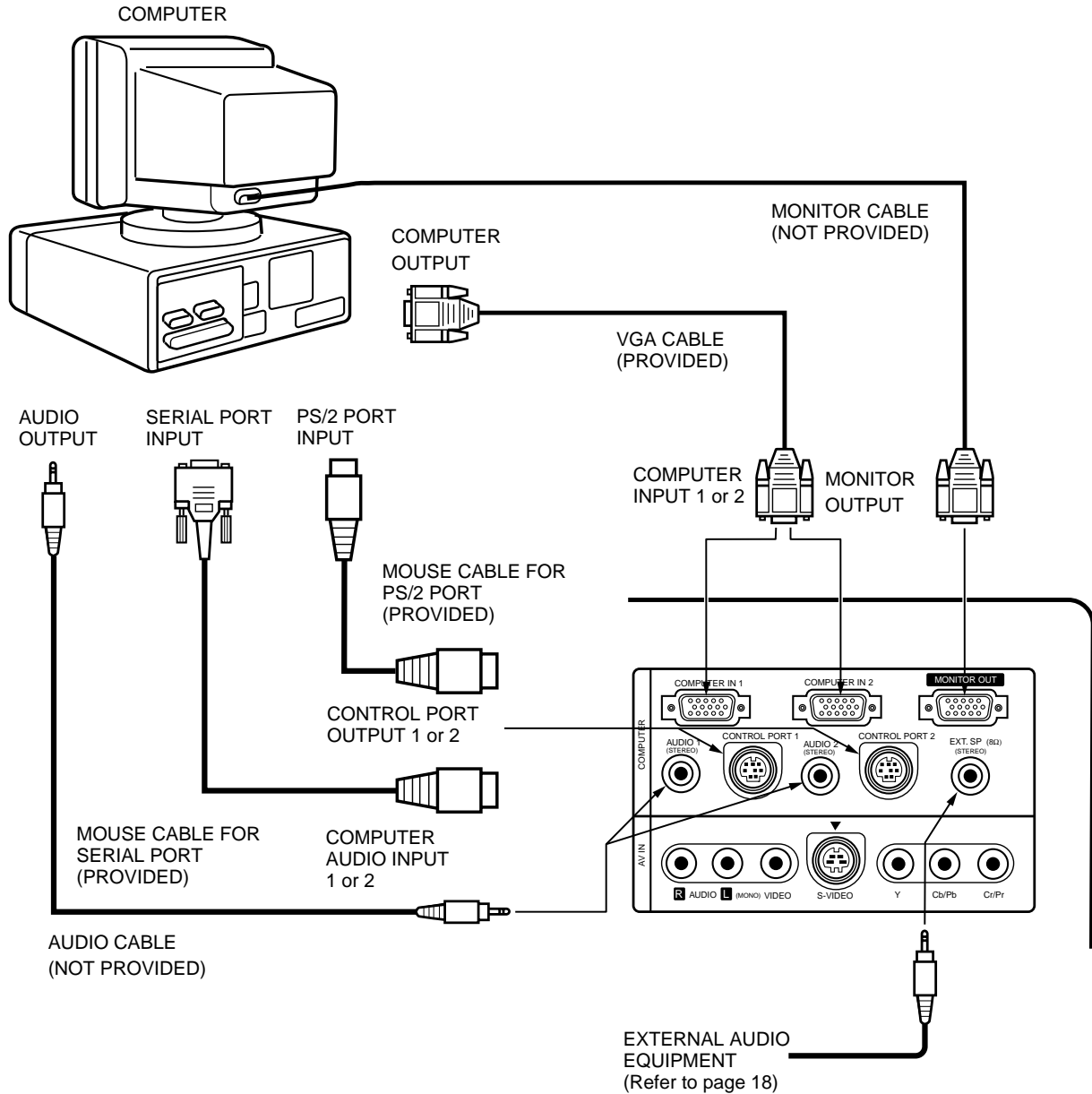

NOTE: When connecting the cable, the power cords of both the projector and the external equipment should be disconnected from AC outlet. Turn the projector and peripheral equipment on before the computer is switched on.

CONNECTING AN IBM-COMPATIBLE LAPTOP COMPUTER

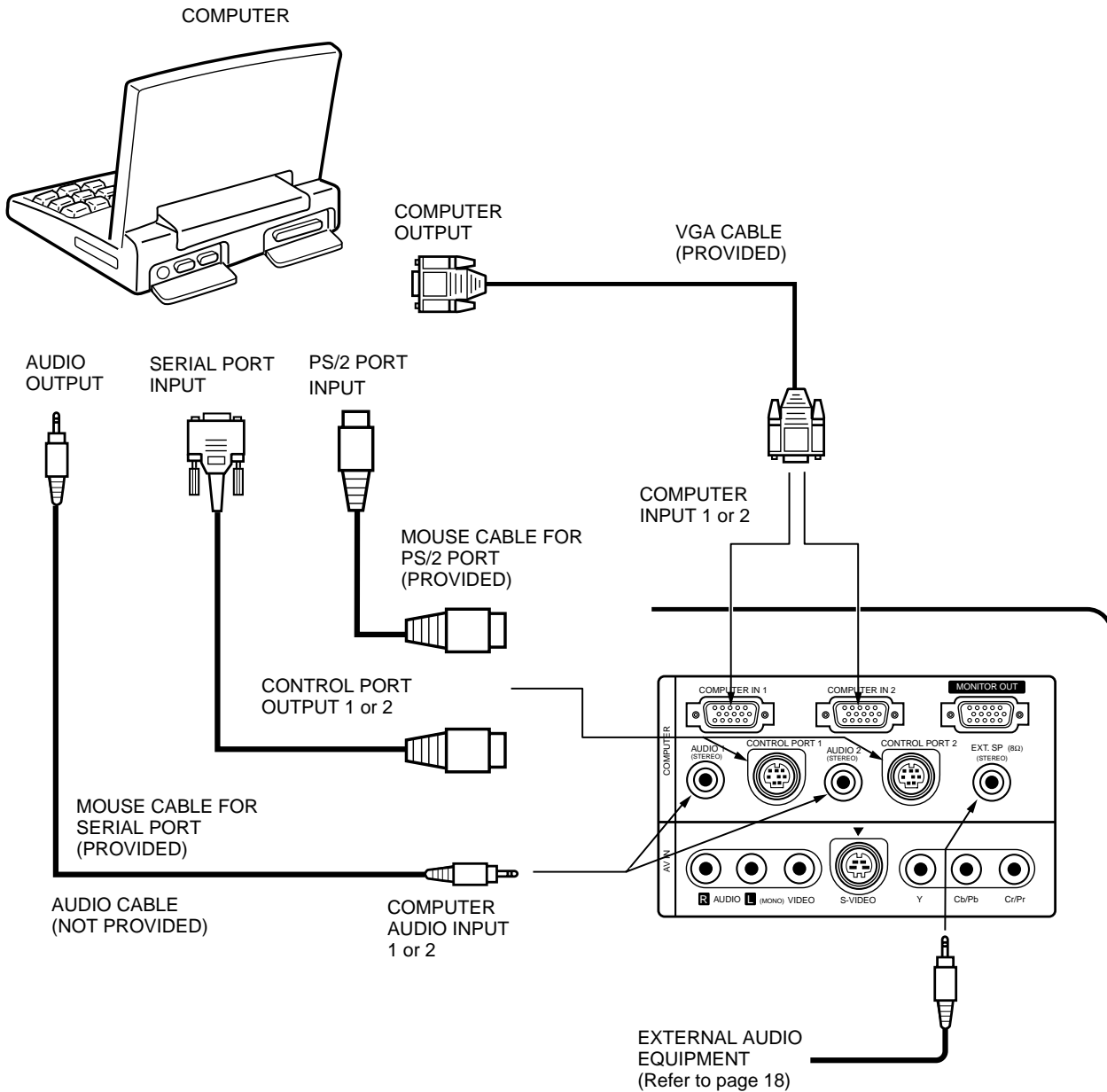

NOTE: When connecting the cable, the power cords of both the projector and the external equipment should be disconnected from AC outlet. Turn the projector and peripheral equipment on before the computer is switched on.

CONNECTING THE PROJECTOR

CONNECTING A MACINTOSH DESKTOP COMPUTER

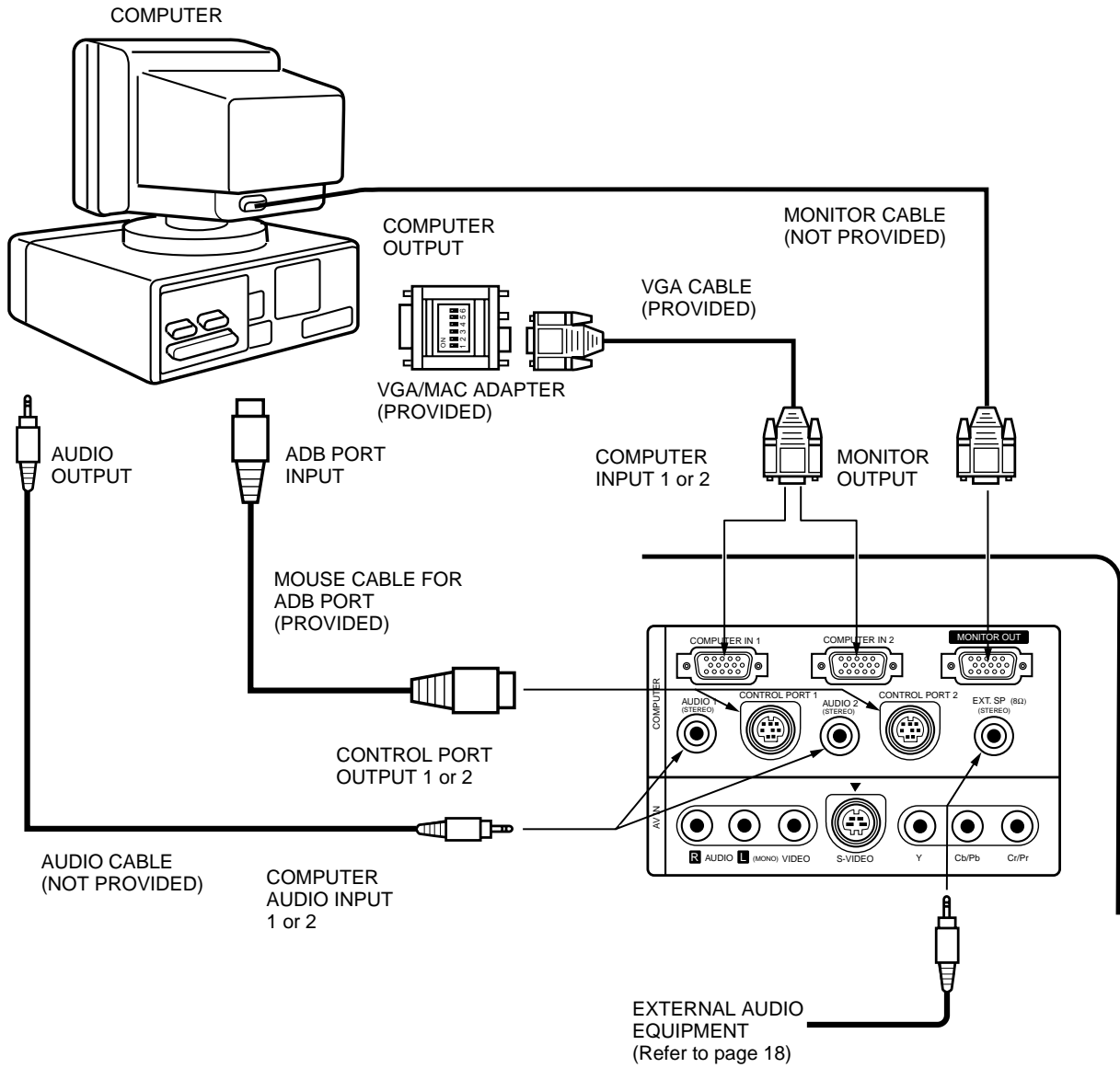

Set the dip switches as shown in the table below depending on the RESOLUTION MODE that you want to use before you turn on the projector and computer.

RESOLUTION MODE	SW1	SW2	SW3	SW4	SW5	SW6
13" MODE (640 x 480)	ON	ON	OFF	OFF	OFF	OFF
16" MODE (832 x 624)	OFF	ON	OFF	ON	OFF	OFF
19" MODE (1024 x 768)	OFF	ON	ON	OFF	OFF	OFF
21" MODE (1152 x 870)	ON	ON	ON	ON	OFF	OFF

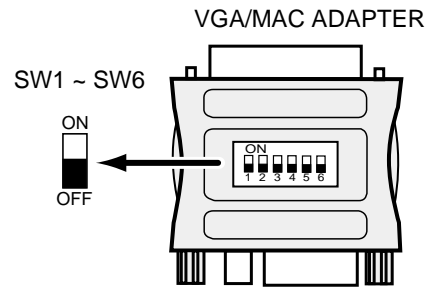

NOTE: When connecting the cable, the power cords of both the projector and the external equipment should be disconnected from AC outlet. Turn the projector and peripheral equipment on before the computer is switched on.

CONNECTING A MACINTOSH POWERBOOK COMPUTER

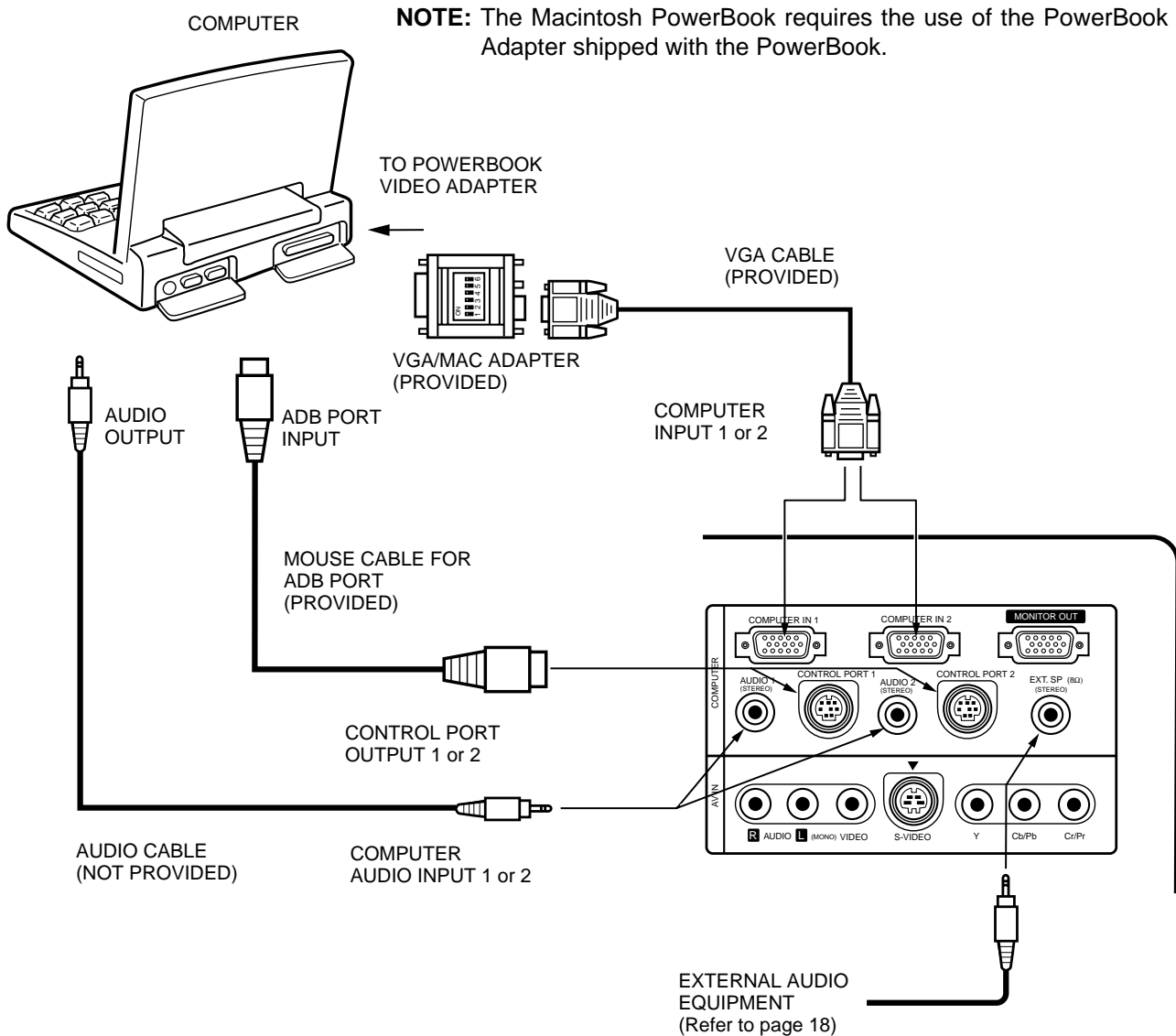

Set the dip switches as shown in the table below depending on the RESOLUTION MODE that you want to use before you turn on the projector and computer.

RESOLUTION MODE	SW1	SW2	SW3	SW4	SW5	SW6
13" MODE (640 x 480)	ON	ON	OFF	OFF	OFF	OFF
16" MODE (832 x 624)	OFF	ON	OFF	ON	OFF	OFF
19" MODE (1024 x 768)	OFF	ON	ON	OFF	OFF	OFF
21" MODE (1152 x 870)	ON	ON	ON	ON	OFF	OFF

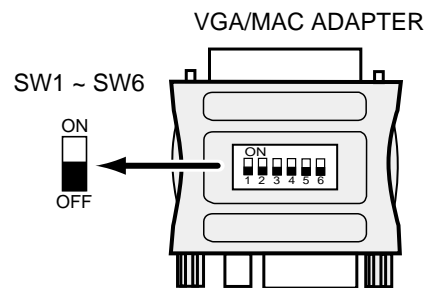

NOTE: When connecting the cable, the power cords of both the projector and the external equipment should be disconnected from AC outlet. Turn the projector and peripheral equipment on before the computer is switched on.

CONNECTING THE VIDEO EQUIPMENT

Connect to the video and audio outputs of a VCR, video disc player, DVD player, video camera, satellite TV tuner or other AV equipment.

CONNECTING TO THE VIDEO INPUT JACK

Connect the video output from the video equipment to this jack using the video cable.

CONNECTING S-VHS VIDEO INPUT JACK

Connect the S-VIDEO output from the video equipment to this jack using the S-video cable. The S-VIDEO jack has priority over the VIDEO (composite) jack.

CONNECTING TO THE COMPONENT VIDEO INPUT JACKS

Connect the component video outputs (Y, Cb/Pb, Cr/Pr) from the DVD player or other video equipment to these jacks using the video cable. The COMPONENT VIDEO jack has priority over the S-VIDEO and VIDEO (composite) jacks.

CONNECTING TO THE AUDIO INPUT JACKS

Connect the audio outputs from the video equipment to these jacks using the audio cable. When the audio output is monaural, connect it to the L (mono) jack.

CONNECTING THE VIDEO EQUIPMENT

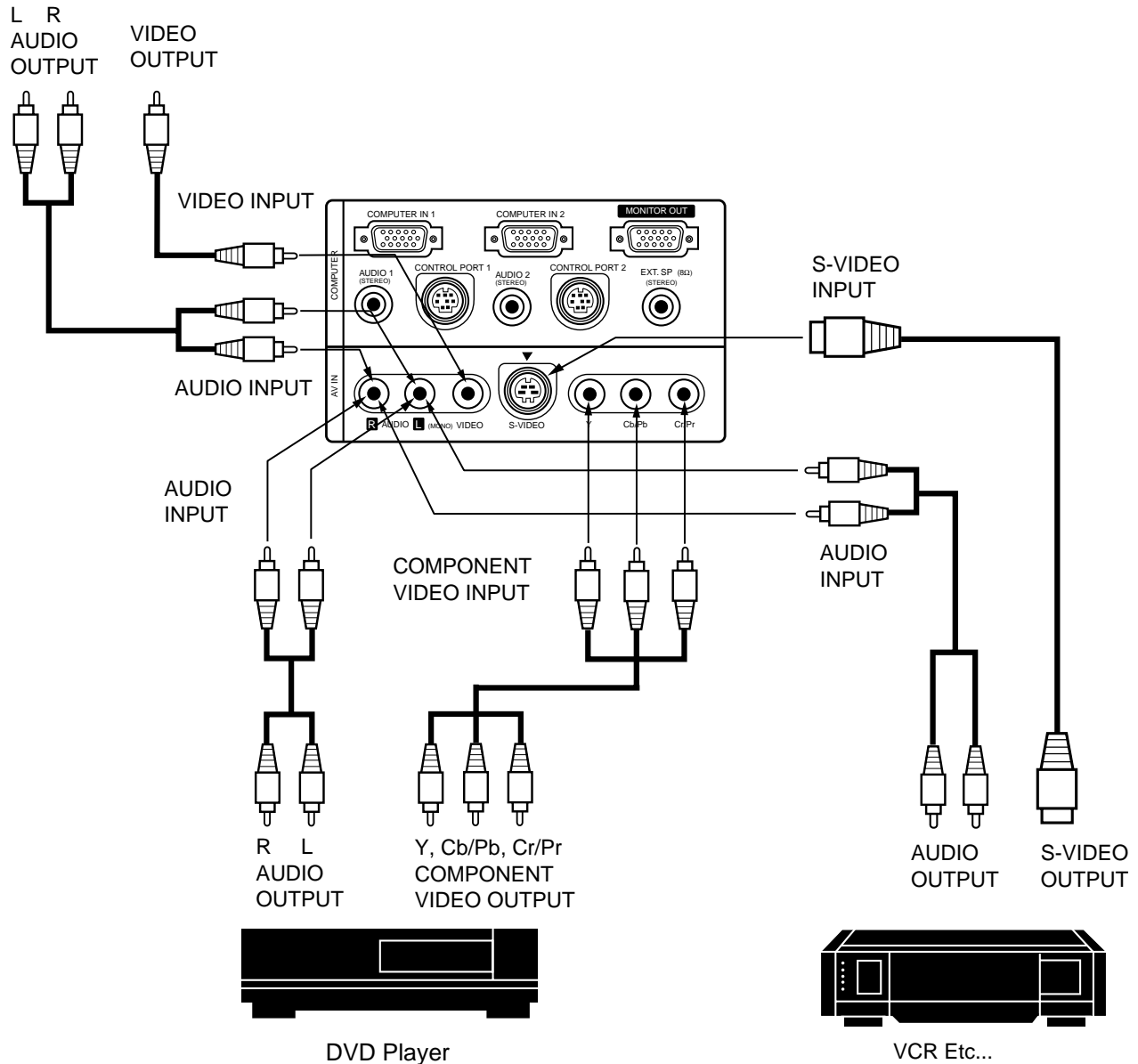
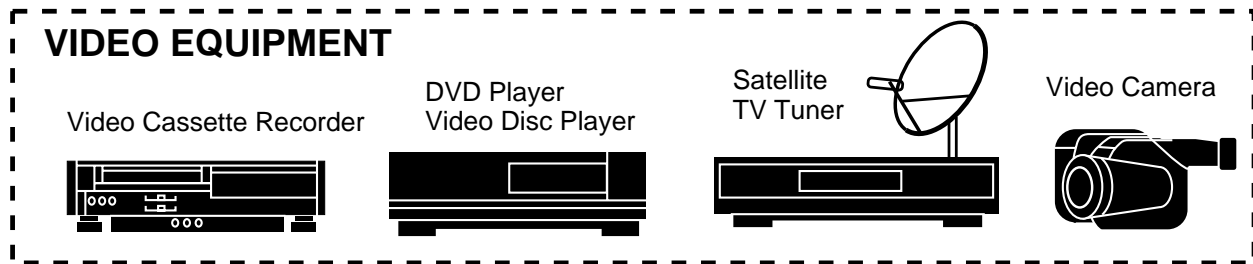

NOTE: When connecting the cable, the power cords of both the projector and the external equipment should be disconnected from AC outlet. Turn the projector on before the peripheral equipment is switched on.

CONNECTING THE PROJECTOR

CONNECTING TO THE EXT. SP. JACK (3.5 mm mini stereo type)

This jack outputs stereo speaker sound which viewing on screen. If you use external speaker system, connect stereo type external speaker jack. Internal speaker sound is disconnected when speaker jack is connected.

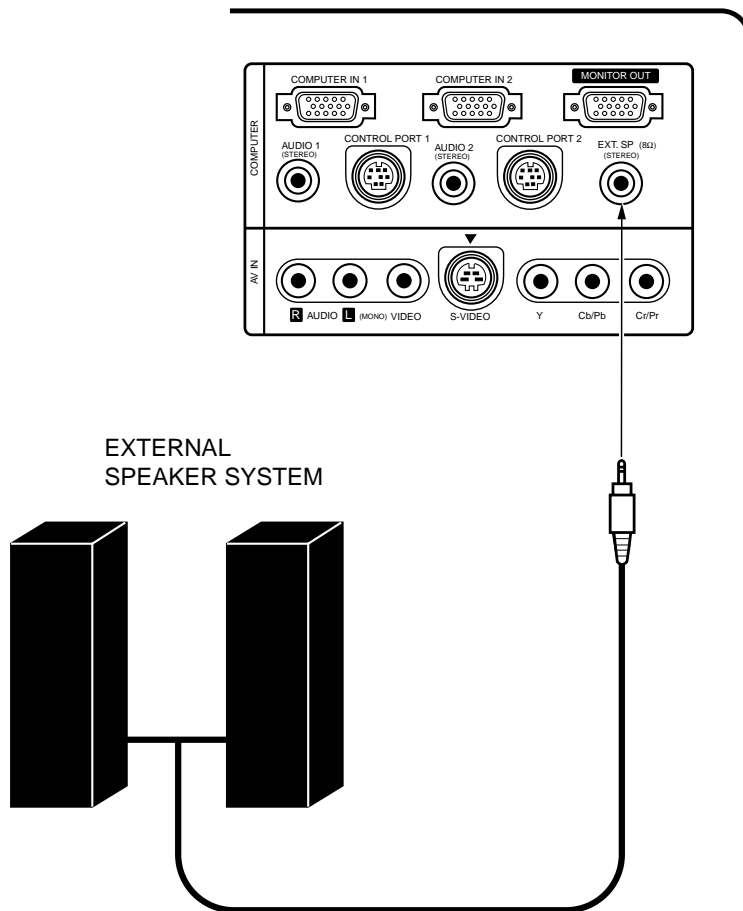

CONTROLS AND INDICATORS

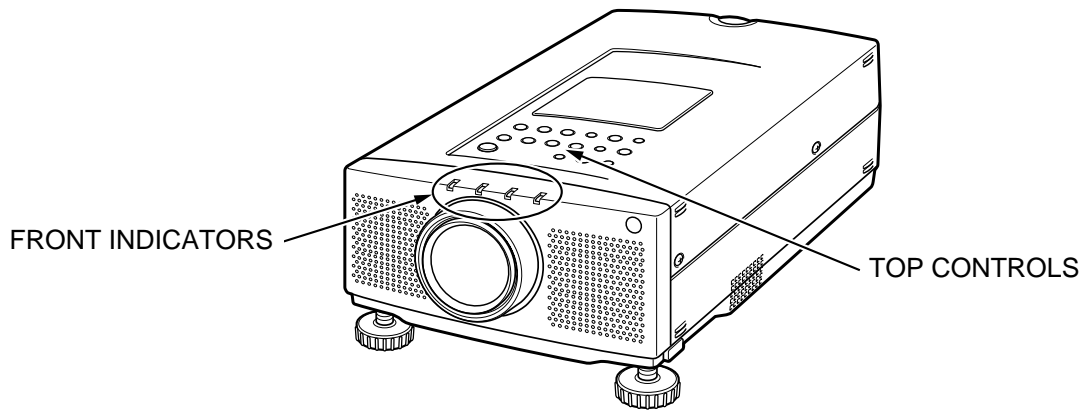

FRONT INDICATORS

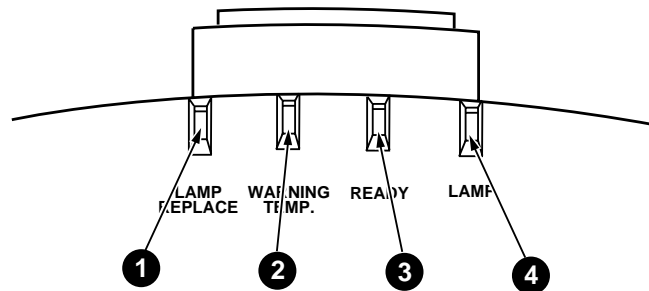

TOP CONTROLS

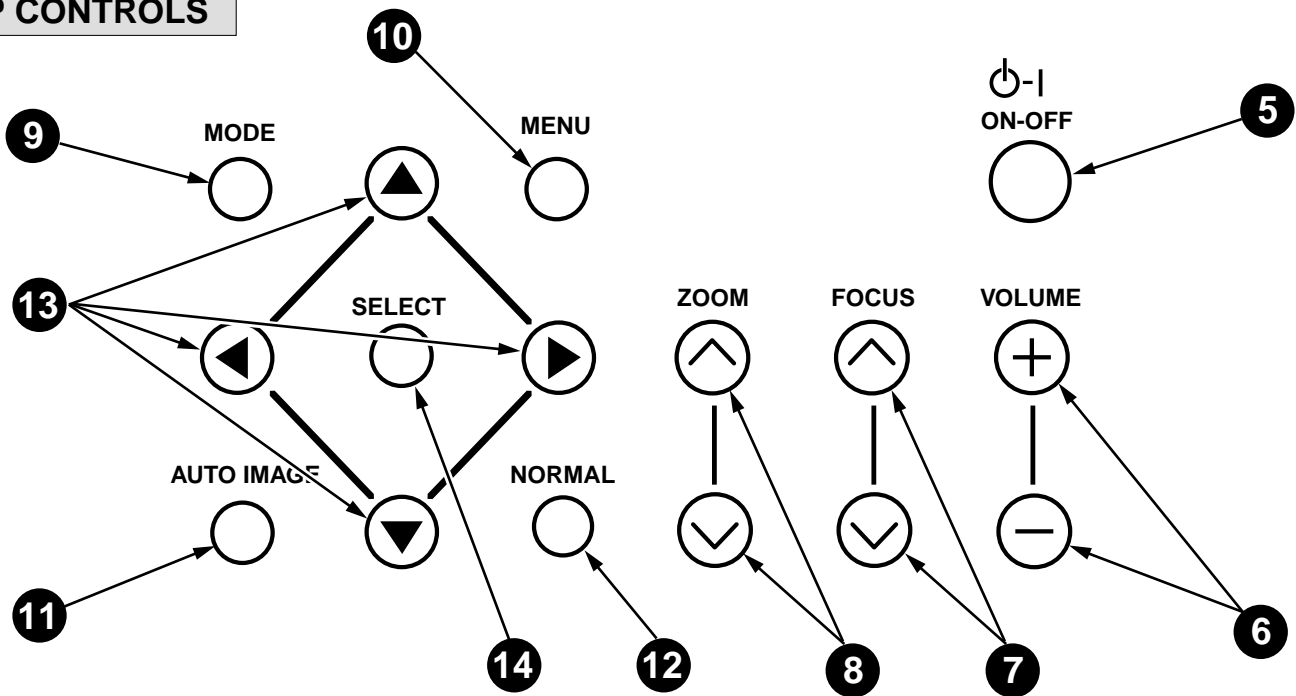

BEFORE OPERATION

- 1 LAMP REPLACEMENT INDICATOR**
Light is orange when the Lamp life draws to an end.
- 2 TEMPERATURE WARNING INDICATOR**
Flashes red when internal projector temperature is too high.
- 3 READY INDICATOR**
Light is green when projector lamp is ready to be turned on.
- 4 LAMP POWER INDICATOR**
Light is dim when the projector is on.
Light is brightened when the projector is in stand-by mode.
- 5 POWER ON/OFF BUTTON**
Used to turn the projector on or off.
- 6 VOLUME BUTTONS**
Used to adjust volume.
- 7 FOCUS BUTTONS**
Used to operate power focus system.
- 8 ZOOM BUTTONS**
Used to operate power zoom lens.
- 9 MODE BUTTON**
Used to select source.
(Computer 1, Computer 2 or Video).
- 10 MENU BUTTON**
This button will activate the MENU operation.
Use this button, the POINT UP/DOWN/LEFT/RIGHT buttons and the SELECT button to make adjustments to the projector's setting in MENU operation.
- 11 AUTO IMAGE BUTTON**
Used to operate the AUTO IMAGE function.
- 12 NORMAL BUTTON**
Use to reset to normal picture adjustment preset by factory.
- 13 POINT UP/DOWN/LEFT/RIGHT BUTTONS**
To select an item on the MENU that you want to adjust. To select an item, move the arrow by pressing these buttons (UP, DOWN, LEFT or RIGHT).
- 14 SELECT BUTTON**
This button has different functions depending on when used. This button is used to execute the item selected, to increase or decrease the values in certain items such as CONTRAST or BRIGHTNESS.

OPERATION OF THE REMOTE CONTROL

This remote control unit is not only able to operate the projector but also usable as a wireless mouse for a PC. One pointing pad and two click buttons are used for wireless mouse operation.

Wireless mouse is usable when PC mouse pointer is displayed on the screen. When the menu or indicator of the projector is displayed on the screen instead of the PC mouse pointer, the wireless mouse cannot be used.

NOTE: To use the unit as a PC wireless mouse, connect the projector to the PC with the attached cable. Signals from the projector are transmitted to the PC, enabling the remote control unit of the projector to be used as a PC wireless mouse. (Refer to "CONNECTING THE PROJECTOR" in pages 11 to 15 for the connection).

LASER POINTER button

This remote control emits a laser beam as the Laser Pointer from the Laser Light Window. When the LASER button is pressed, the laser light goes on. When the button is pressed more than 1 minute or the button is released, light goes off. Laser light is emitted with the RED light which tells the laser beam being emitted. The laser emitted is a class II laser; therefore, do not look into the Laser Light Window or shine the laser beam on yourself or other people. The three marks to the right are the caution labels for the laser beam.

CAUTION: Use of controls or adjustments or performance of procedures other than those specified herein may result in hazardous radiation exposure.

INFRARED
SIGNAL
WINDOW

LASER LIGHT WINDOW

AVOID EXPOSURE-LASER
RADIATION IS EMITTED
FROM THIS APERTURE
レーザー光の出口
ビームをのぞき込まないこと

CAUTION

LASER RADIATION-
DO NOT STARE INTO BEAM



MAX OUTPUT : 1mW
WAVE LENGTH : 650±20nm
CLASS II LASER PRODUCT

This product is complied with 21 CFR
part 1040.10

LASER RADIATION
DO NOT STARE INTO BEAM
CLASS 2 LASER PRODUCT
LASER-STRAHLUNG
NICHT IN DEN STRAHL BLICKEN
LASR KLASSE 2
レーザー放射 クラス2 レーザ製品
ビームをのぞき込まないこと
IEC60825-1, Am.1 1997
MAX OUTPUT (最大出力) : 1mW
WAVE LENGTH (波長) : 650±20nm

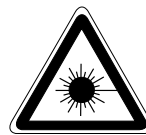

FRONT

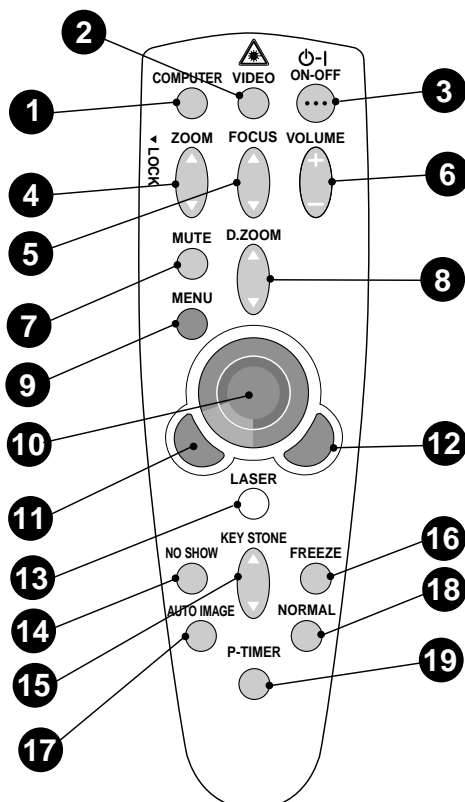

LASER POINTER
button

SIDE

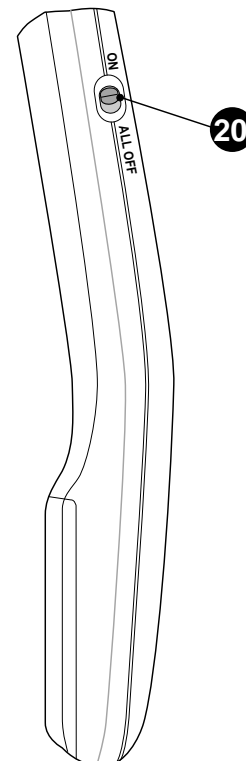

BEFORE OPERATION

- 1 COMPUTER SELECT BUTTON**
Used to select computer mode. (Computer 1 or Computer 2 Input)
- 2 VIDEO SELECT BUTTON**
Used to select video mode.
- 3 POWER ON/OFF BUTTON**
Used to turn the projector on or off.
- 4 ZOOM BUTTONS**
Used to operate power zoom lens.
- 5 FOCUS BUTTONS**
Used to operate power focus system.
- 6 VOLUME BUTTONS**
Used to adjust volume.
- 7 SOUND MUTE BUTTON**
Used to mute sound.
- 8 DIGITAL ZOOM BUTTONS**
Used to operate digital zoom function.
- 9 MENU BUTTON**
This button will activate the MENU operation. Use this button, the POINT UP/DOWN/LEFT/RIGHT button and the SELECT button to make adjustments to the projector's setting in MENU operation.
- 10 POINTING PAD (POINT UP/DOWN/LEFT/RIGHT BUTTON)**
When in use as a remote for the projector
To select an item on the MENU that you want to adjust. To select an item, move the arrow by pressing the pad upward, downward, leftward or rightward. When pressing the center of this button, it works as the SELECT button.
When in use as a wireless mouse
Used to move the pointer. The pointer is moved according to the direction you are pressing.
- 11 SELECT BUTTON**
When in use as a remote for the projector.
This button has different functions depending on when used. This button is used to execute the item selected, to increase or decrease the values in certain items such as CONTRAST or BRIGHTNESS.
When in use as a wireless mouse
This button has the same function as the left button in a PC mouse.
- 12 FRONT CLICK BUTTON**
When in use as a remote for the projector
Used to compress the image in D.ZOOM mode.
When in use as a wireless mouse
This button has the same function as the right button in a PC mouse.
- 13 LASER BUTTON**
Used to operate laser pointer function. The laser beam is emitted while pressing this button within 1 minute. When using the laser pointer for more than 1 minute, release the button and press it again.
- 14 NO SHOW BUTTON**
Used to change the screen into black image.
- 15 KEYSTONE BUTTONS**
Used to revise the keystone distortion.
- 16 FREEZE BUTTON**
Used this button to freeze on-screen image.
- 17 AUTO IMAGE BUTTON**
Used to operate the AUTO IMAGE function.
- 18 NORMAL BUTTON**
Used to reset to normal picture adjustment preset by factory.
- 19 P-TIMER BUTTON**
Used to operate the P-TIMER function.
- 20 ALL-OFF SWITCH**
Turn this switch to "ALL OFF" when the Remote Control is not used for extended period.

Remote Control Battery Installation

1 Remove the battery compartment lid.

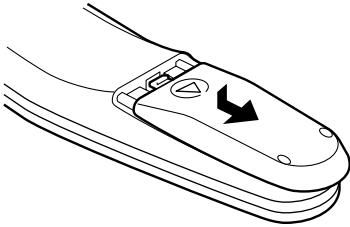

2 Slide the batteries into the compartment.

Note : For correct polarity (+ and - terminal), be sure the battery terminals are in contact with the pins in the compartment.

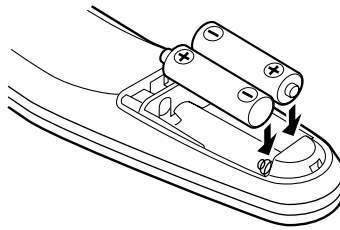

3 Replace the compartment lid.

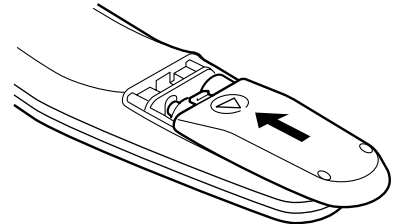

Using the Remote Control Unit

Point the remote control toward the projector (Receiver window) when pressing the buttons. Maximum operating range for the remote control is about 5 m and 60° front and rear of the projector.

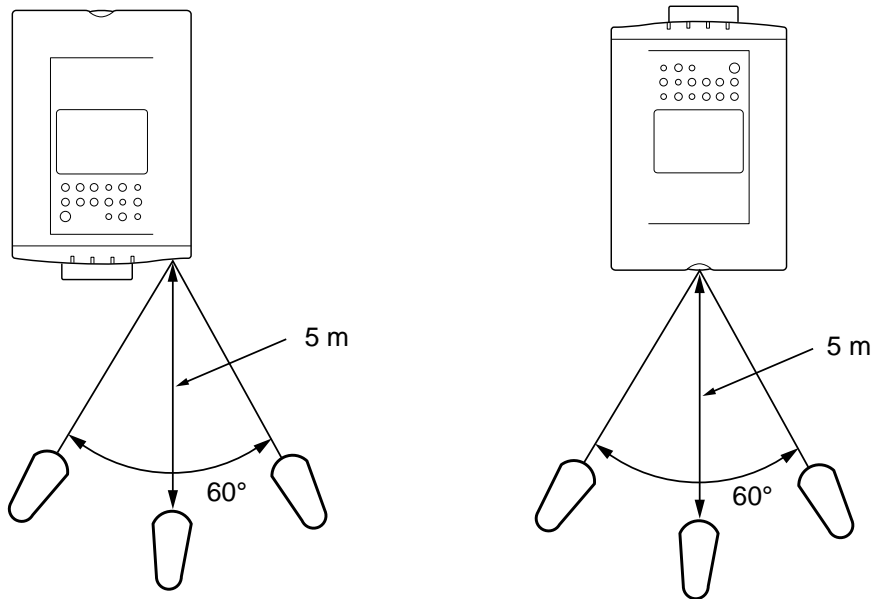

To insure safe operation, please observe the following precautions:

- Use (2) AA, UM3 or R06 type alkaline batteries.
- Change two batteries at the same time.
- Do not use a new battery with a used battery.
- Avoid contact with water.
- Do not drop the remote control unit.
- If batteries have leaked on the remote control, carefully wipe the case clean and load new batteries.

CONTROL THE PROJECTOR

The projector has two types of operation: DIRECT OPERATION and MENU OPERATION.

DIRECT OPERATION allows you to operate the projector by using one button without showing the MENU.

In MENU OPERATION mode, you display menus where you can adjust the projector's settings. Follow the instruction for each control.

DIRECT OPERATION

ADJUST ITEM	TOP CONTROL OF THE PROJECTOR	REMOTE CONTROL
LAMP POWER ON/OFF	POWER ON-OFF	POWER ON-OFF
MODE SELECT	MODE	COMPUTER VIDEO
SOUND VOLUME	VOLUME (+) and (-)	VOLUME (+) and (-)
SOUND MUTE	_____	MUTE
ZOOM	ZOOM (▲) and (▼)	ZOOM (▲) and (▼)
FOCUS	FOCUS (▲) and (▼)	FOCUS (▲) and (▼)
DIGITAL ZOOM	_____	D. ZOOM (▲) and (▼)
KEystone	_____	KEYSTONE (▲) and (▼)
NO SHOW	_____	NO SHOW
FREEZE PICTURE	_____	FREEZE
AUTO IMAGE	AUTO IMAGE	AUTO IMAGE
NORMAL PICTURE	NORMAL	NORMAL
P-TIMER	_____	P-TIMER

MENU OPERATION

ADJUST ITEM	TOP CONTROL OF THE PROJECTOR	REMOTE CONTROL
MODE SELECT	MENU POINT LEFT/RIGHT SELECT POINT UP/DOWN SELECT	MENU POINT LEFT/RIGHT SELECT POINT UP/DOWN SELECT

1. COMPUTER/VIDEO MODE

ADJUST ITEM	TOP CONTROL OF THE PROJECTOR	REMOTE CONTROL
SOUND SOUND VOLUME SOUND MUTE	MENU POINT LEFT/RIGHT SELECT POINT UP/DOWN SELECT	MENU POINT LEFT/RIGHT SELECT POINT UP/DOWN SELECT
LANGUAGE		
SETTING BLUE BACK DISPLAY CEILING REAR SPLIT WIPE POWER MANAGEMENT REMOTE CONTROL LAMP AGE	MENU POINT LEFT/RIGHT SELECT POINT UP/DOWN SELECT	MENU POINT LEFT/RIGHT SELECT POINT UP/DOWN SELECT

2. VIDEO MODE

ADJUST ITEM	TOP CONTROL OF THE PROJECTOR	REMOTE CONTROL
COLOUR SYSTEM	MENU POINT LEFT/RIGHT SELECT	MENU POINT LEFT/RIGHT SELECT
VIDEO SOURCE	POINT UP/DOWN SELECT	POINT UP/DOWN SELECT
PICTURE IMAGE COLOUR TINT WHITE BALANCE CONTRAST BRIGHTNESS SHARPNESS PROGRESSIVE	MENU POINT LEFT/RIGHT SELECT POINT UP/DOWN SELECT	MENU POINT LEFT/RIGHT SELECT POINT UP/DOWN SELECT
PICTURE SCREEN WIDE REGULAR KEystone		

3. COMPUTER MODE

ADJUST ITEM	TOP CONTROL OF THE PROJECTOR	REMOTE CONTROL
COMPUTER SYSTEM	MENU POINT LEFT/RIGHT SELECT POINT UP/DOWN SELECT	MENU POINT LEFT/RIGHT SELECT POINT UP/DOWN SELECT
AUTO IMAGE FINE SYNC TOTAL DOTS POSITION	MENU POINT LEFT/RIGHT SELECT POINT UP/DOWN SELECT	MENU POINT LEFT/RIGHT SELECT POINT UP/DOWN SELECT
PICTURE IMAGE FINE SYNC TOTAL DOTS WHITE BALANCE CONTRAST BRIGHTNESS	MENU POINT LEFT/RIGHT SELECT POINT UP/DOWN SELECT	MENU POINT LEFT/RIGHT SELECT POINT UP/DOWN SELECT
PICTURE POSITION	MENU POINT LEFT/RIGHT SELECT POINT LEFT/RIGHT/UP/DOWN SELECT	MENU POINT LEFT/RIGHT SELECT POINT LEFT/RIGHT/UP/DOWN SELECT
PC ADJUSTMENT	MENU POINT LEFT/RIGHT SELECT POINT UP/DOWN SELECT	MENU POINT LEFT/RIGHT SELECT POINT UP/DOWN SELECT
PICTURE SCREEN TRUE DIGITAL ZOOM KEystone	MENU POINT LEFT/RIGHT SELECT POINT UP/DOWN SELECT POINT LEFT/RIGHT/UP/DOWN	MENU POINT LEFT/RIGHT SELECT POINT UP/DOWN SELECT SELECT FRONT CLICK POINT LEFT/RIGHT/UP/DOWN

NOTES :

1. If you switch to DIRECT operation by pressing a DIRECT operation button while in MENU mode, the menus will disappear and the MENU operation will end.
2. You can use the REMOTE CONTROL UNIT or the TOP CONTROL OF THE PROJECTOR to operate the MENU operation.

BASIC OPERATION

TURNING ON/OFF THE PROJECTOR

TO TURN ON THE PROJECTOR

Connect the projector to a source (Computer, VCR, Video Camera, Video Disc Player, etc.) using the appropriate terminals on the rear of the projector. (See "CONNECTING THE PROJECTOR" section on pages 11-18).

Connect the projector's AC power cord into a wall outlet and turn the MAIN ON/OFF switch (located on the rear of the projector) to the ON position. The LAMP POWER indicator will light RED, the READY indicator will light GREEN.

Press the POWER ON/OFF button on the remote control unit or on the projector to ON. The LAMP POWER indicator light will dim and the cooling fans will operate. The wait display appears on the screen and the count-down starts (30-29-28-...1). The signal from the source appears after 30 seconds.

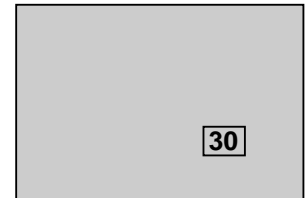

CAUTION:

TO MAINTAIN THE LIFE OF THE LAMP, ONCE YOU HAVE TURNED IT ON, WAIT AT LEAST 5 MINUTES BEFORE TURNING IT OFF.

NOTE: TEMPERATURE WARNING INDICATOR flashes red, the projector will automatically turn off. Wait at least 5 minutes before turning the projector on.

If the TEMPERATURE WARNING INDICATOR continued to flash, follow the procedures below:

- (1). Press POWER ON/OFF button to OFF.
- (2). Check the air filter for dust accumulation.
- (3). Remove dust with vacuum cleaner. (See "AIR FILTER CARE AND CLEANING" section on page 49).
- (4). Press POWER ON/OFF button to ON.

If the TEMPERATURE WARNING INDICATOR still continues to flash, call your authorized dealer or service station.

TO TURN OFF THE PROJECTOR

Press the POWER ON/OFF button on the remote control unit or on the projector. The "Power off ?" appears on the screen. Press again the POWER ON/OFF button to turn OFF the projector. The LAMP POWER indicator will light bright and READY indicator will turn off. After approximate 1 minute, the READY indicator will light green again and the projector may be turned on by pressing the POWER ON/OFF button. The cooling fans will operate for approximate 2 minutes after the projector is turned off. To power down completely, turn the MAIN ON/OFF switch (located on the rear of the projector) to the OFF position.

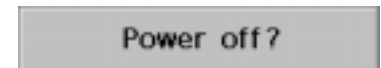

DIRECT OPERATION

MODE SELECT

Press the MODE button on the projector or the COMPUTER and VIDEO button on the remote control unit to select Computer 1, Computer 2, Video Input. The "Computer 1", "Computer 2" or "Video" display will appear on the screen for a few seconds.

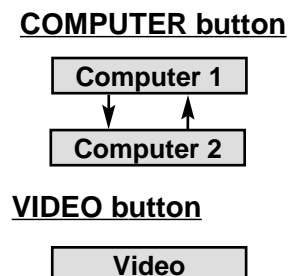
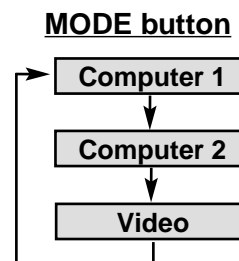

SOUND VOLUME ADJUSTMENT

Press the VOLUME buttons on the remote control unit or on the projector to adjust the volume. The volume display will be displayed on the screen for a few seconds. Pressing volume (+) will increase volume and increase the number on the screen. Pressing volume (-) will decrease volume and decrease the number on the screen.

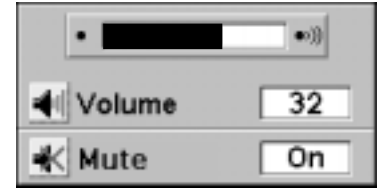

SOUND MUTE FUNCTION

Pressing the MUTE button on the remote control unit will mute audio. Press the MUTE button again to restore audio to its previous level. The mute display will be displayed on the screen for a few seconds.

ZOOM ADJUSTMENT

Press the ZOOM (▲) or (▼) button on the remote control unit or on the projector to obtain your desired picture size. For a larger picture, press (▲) and for a smaller picture, press (▼).

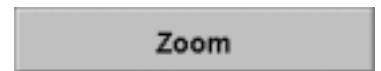

FOCUS ADJUSTMENT

Press the FOCUS (▲) or (▼) button on the remote control unit or on the projector for a sharper, crisper picture.

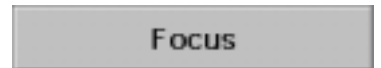

DIGITAL ZOOM FUNCTION

Press the D. ZOOM (▲) or (▼) button on the remote control unit. The "D. Zoom" and the magnifying-glass icon is displayed to indicate Digital zoom mode. Digital zoom mode can be adjust the image size or pan the image.

To expand the image size, press D. ZOOM (▲). The image is magnified by degrees (Expand function).

To compress the image size, press D. ZOOM (▼) button. The size of image is reduced by degrees (Compress function).

To pan the image, press POINT UP/DOWN/LEFT/RIGHT (POINTING PAD) button. The image move to the direction indicated (Panning function).

See page 45 for more detail.

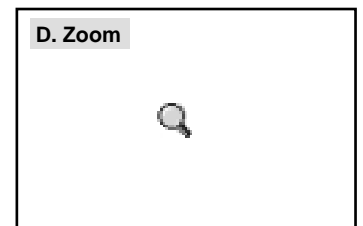

KEYSTONE FUNCTION

If the picture have keystone distortion, correct screen with KEYSTONE adjustment. Press the KEYSTONE (▲) or (▼) button on the remote control unit or select the Keystone on the SCREEN menu. (See pages 35 and 45). The "Keystone" is displayed to indicate Keystone mode.

Press the KEYSTONE (▲) button or the POINT UP button to reduce the upper part of the image, and the KEYSTONE (▼) button or the POINT DOWN button to reduce the lower part.

Press the NORMAL button in keystone mode, the image changed to the original image (not correct keystone distortion).

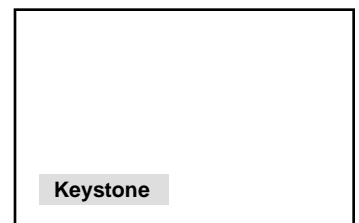

The message disappears after 4 seconds.

Reduce the upper width with the KEYSTONE (▲) button or the POINT UP button.

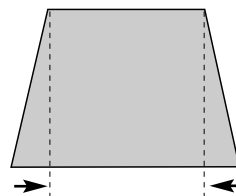
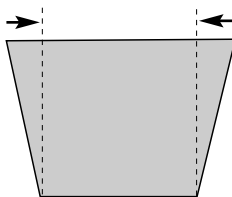

Reduce the lower width with the KEYSTONE (▼) button or the POINT DOWN button.

NO SHOW FUNCTION

Press the NO SHOW button on the remote control unit. The screen will change into black image and the "NO SHOW" is displayed on the screen for a few seconds. This function is cancelled when the NO SHOW button is pressed again or any other function button is pressed.

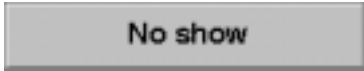

No show

FREEZE PICTURE FUNCTION

Press the FREEZE button on the remote control unit to freeze the picture on screen. This function is cancelled when the FREEZE button is pressed again or any other button is pressed.

NOTE: Your computer or video equipment is not affected by this function, and will continue to run.

AUTO IMAGE FUNCTION

Press the AUTO IMAGE button on the remote control unit or on the projector. The item(s) indicated "ON" in the AUTO IMAGE FUNCTION are adjusted automatically.

If all the items in AUTO IMAGE FUNCTION are "OFF", AUTO IMAGE SETTING display appears. If you wish to operate the AUTO IMAGE FUNCTION, perform the steps 3 - 9 of "AUTO IMAGE FUNCTION" section on page 38.

NORMAL PICTURE FUNCTION

The normal picture image level is factory preset on the projector and can be restored anytime by pressing the NORMAL button on the remote control unit or on the projector. The "Normal" display will be displayed on the screen for a few seconds.





Normal

P-TIMER FUNCTION

Press the P-TIMER button on the remote control unit. The timer display "00:00" appears on the screen and the timer starts to count the time (00:00 to 59:59).

Press again the P-TIMER button to stop the timer. Then press the P-TIMER button to cancel the P-TIMER function.



 00:01

MENU OPERATION

In MENU OPERATION mode, you display menus where you can adjust the projector's settings. You can use the TOP CONTROL OF THE PROJECTOR or the REMOTE CONTROL UNIT.

TOP CONTROL OF THE PROJECTOR

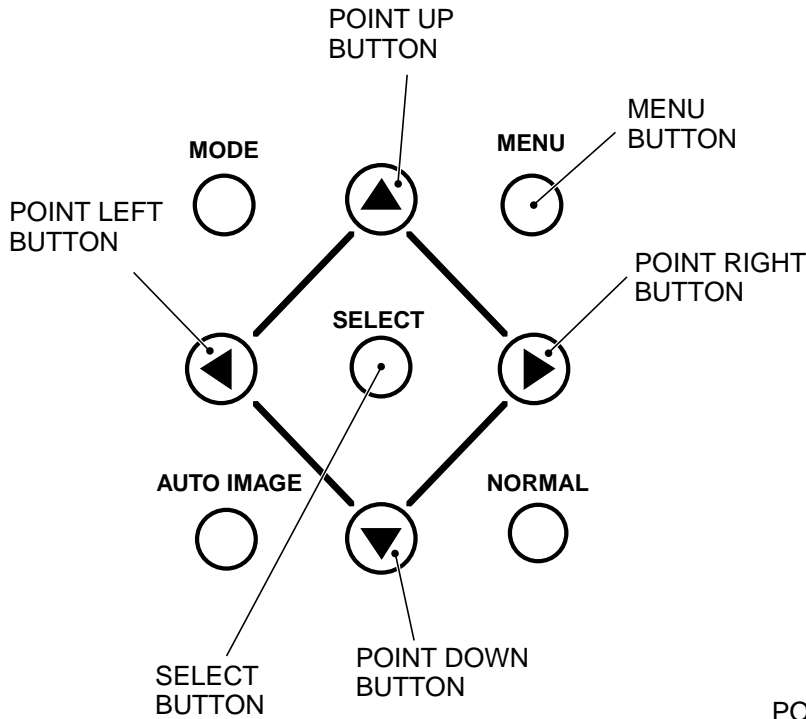

REMOTE CONTROL UNIT

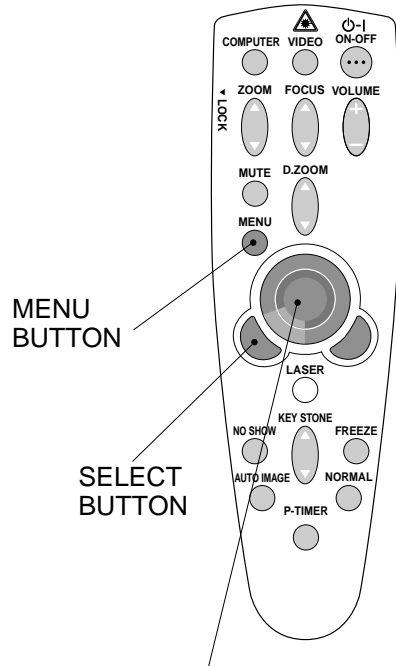

POINT (UP/DOWN/LEFT/RIGHT) BUTTON
Pressing the button upward, downward, leftward or rightward.

MODE SELECT

You can select a mode from MAIN MENU display among computer 1, computer 2 and video.

1. Press the MENU BUTTON and the MAIN MENU DISPLAY dialog box will appear.
2. Press the POINT LEFT/RIGHT BUTTON(s) to select Computer or Video and press the SELECT BUTTON. Another dialog box MODE DISPLAY will appear.
3. Press the POINT DOWN BUTTON and a red arrow will appear.
4. Move the arrow to the mode you want (computer 1, computer 2 or video) to use by pressing the POINT UP/DOWN BUTTON(s) and then press the SELECT BUTTON.

MAIN MENU DISPLAY



MODE DISPLAY

MAIN MENU DISPLAY



SOUND ADJUSTMENT

You can adjust the sound volume and sound mute ON/OFF switch in the MENU display.

1. Press the MENU BUTTON and the MAIN MENU DISPLAY dialog box will appear.
2. Press the POINT LEFT/RIGHT BUTTON(s) to select SOUND and press the SELECT BUTTON. Another dialog box SOUND ADJUST DISPLAY will appear.
3. Press the POINT DOWN BUTTON and a red arrow will appear.
4. Move the arrow to an item that you want to adjust by pressing the POINT UP/DOWN BUTTON(s).
5. To increase the sound volume, point the arrow to ▲ and then press the SELECT BUTTON. To decrease the sound volume, point the arrow to ▼ and then press the SELECT BUTTON.
6. To mute the sound, point the arrow to Mute and then press the SELECT BUTTON. The display is changed On and mute the sound.
7. To quit the MENU, point to Quit and then press the SELECT BUTTON.

MAIN MENU DISPLAY



LANGUAGE ADJUSTMENT

A language in the MENU display can be selected among English, German, French, Italian, Spanish and Japanese.

1. Press the MENU BUTTON and the MAIN MENU DISPLAY dialog box will appear.
2. Press the POINT LEFT/RIGHT BUTTON(s) to select LANGUAGE and press the SELECT BUTTON. Another dialog box LANGUAGE SETTING DISPLAY will appear.
3. Press the POINT DOWN BUTTON and a red arrow will appear.
4. Move the arrow to the language you want to use by pressing the POINT UP/DOWN BUTTON(s) and then press the SELECT BUTTON.

MAIN MENU DISPLAY



VIDEO MODE

COLOUR SYSTEM SELECT

This projector is compatible with the six major broadcast video standards: PAL, SECAM, NTSC, NTSC 4.43, PAL-M and PAL-N (COLOUR SYSTEMs). When the colour system is set to "Auto position", this projector can detect one of 4 systems (PAL, SECAM, NTSC or NTSC 4.43) automatically. However, if the video signal is not strong enough to detect the video format, the projector may not reproduce the proper video image. In case this happens, this projector allows you to choose a specific broadcast signal format.

1. Connect the video equipment to the PROJECTOR and turn the projector on first.
2. Set MODE SELECT to "VIDEO MODE".
3. Press the MENU BUTTON and the MAIN MENU DISPLAY dialog box will appear.
4. Press the POINT LEFT/RIGHT BUTTON(s) to select SYSTEM and press the SELECT BUTTON. Another dialog box COLOUR SYSTEM DISPLAY will appear. The current COLOUR SYSTEM is displayed in the system window.
5. Press the POINT DOWN BUTTON and a red arrow will appear.
6. To change the current COLOUR SYSTEM, press the POINT UP/DOWN BUTTON(s) to move the arrow to a desirable system and then press the SELECT BUTTON.

MAIN MENU DISPLAY



VIDEO SOURCE SELECT

This projector is compatible with 4 types video source input: Composite Video, S-Video, Component Video (Y, Cb, Cr) and Component Video (Y, Pb, Pr).

When the video source is set to "Auto" position this projector can detect one of 3 types Composite Video, S-Video and Component Video (Y, Cb,Cr) automatically. However, if the input video source is Component Video (Y, Pb, Pr), the projector may not detect the video source.

1. Connect the video equipment to the PROJECTOR and turn the projector on first.
2. Set MODE SELECT to "VIDEO MODE".
3. Press the MENU BUTTON and the MAIN MENU DISPLAY dialog box will appear.
4. Press the POINT LEFT/RIGHT BUTTON(s) to select VIDEO SOURCE and press the SELECT BUTTON. Another dialog box VIDEO SOURCE DISPLAY will appear. The current VIDEO SOURCE is displayed in the window.
5. Press the POINT DOWN BUTTON and a red arrow will appear.
6. To change the current VIDEO SOURCE, press the POINT UP/DOWN BUTTON(s) to move the arrow to a desirable video source and then press the SELECT BUTTON.

MAIN MENU DISPLAY



COMPONENT VIDEO SYSTEM SELECT

When you select the "Y, Pb, Pr" by video source select. You must select the component video system (1080i-60, 1080i-50, 1035i, 720p, 575p, 480p).

1. Press the POINT LEFT/RIGHT BUTTON(s) to select SYSTEM and press the SELECT BUTTON. Another dialog box COMPONENT VIDEO SYSTEM DISPLAY will appear. The current SYSTEM is displayed in the system window.
2. Press the POINT DOWN BUTTON and a red arrow will appear.
3. To change the current SYSTEM, press the POINT UP/DOWN BUTTON(s) to move the arrow to a desirable system and then press the SELECT BUTTON.

MAIN MENU DISPLAY

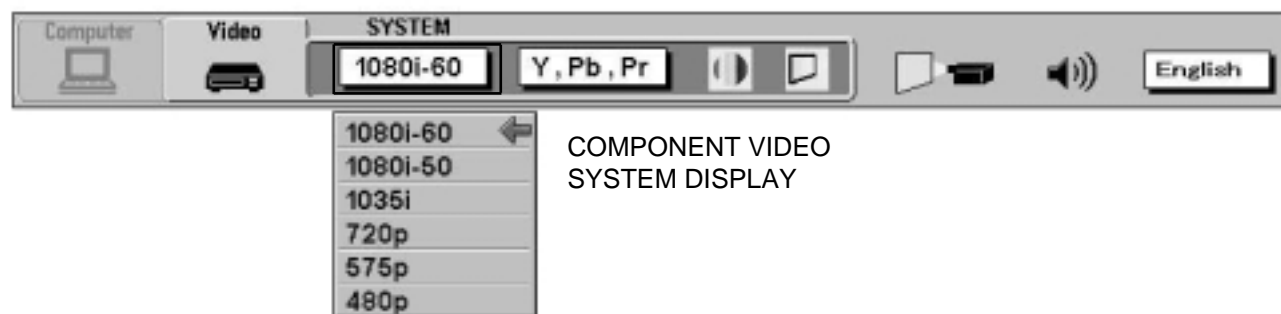

PICTURE IMAGE ADJUSTMENT

Picture adjustments have been preset at the factory. If you want to change the setting, operate the projector as follows.

1. Press MENU BUTTON and the MAIN MENU DISPLAY dialog box will appear.
2. Press the POINT LEFT/RIGHT BUTTON(s) to select IMAGE and press the SELECT BUTTON. Another dialog box IMAGE ADJUST DISPLAY will appear. This shows the current picture settings.
3. In this dialog box, you can adjust the settings by increasing or decreasing the levels shown as numbers. The items and the range of the levels that you can adjust are summarized in the table below.
4. Press the POINT DOWN BUTTON and a red arrow will appear.
5. Move the arrow to an item that you want to adjust by pressing the POINT UP/DOWN BUTTON(s).
6. To increase the level, point the arrow to ▲ and then press the SELECT BUTTON. To decrease the level, point the arrow to ▼ and then press the SELECT BUTTON.
7. You may want to store the settings in the memory so that you can recall them later. To store the settings, move the arrow to Stored and then press the SELECT BUTTON. When you have stored the settings, "OK ?" is displayed for confirmation.
8. Move the arrow to Yes and then press the SELECT BUTTON. The stored settings are memorized even if the MAIN ON/OFF is switched off.
9. To quit the MENU, move the arrow to Quit and then press the SELECT BUTTON.
10. If you do not want to store the settings, move the arrow to Quit and then press the SELECT BUTTON. The settings changed remains effective until the MAIN ON/OFF switch is turned off.
11. To recall the settings from the memory that you have stored, move the arrow to Reset and then press the SELECT BUTTON. When you have reset the settings, "OK ?" is displayed for confirmation. Move the arrow to Yes and then press the SELECT BUTTON. You can adjust the settings again if needed.

NOTE : "TINT" will be skipped in the PAL, SECAM, PAL-M and PAL-N mode.

MAIN MENU DISPLAY



IMAGE ADJUST DISPLAY



PROGRESSIVE

Set "On" to provide progressive scan mode.

NOTE: The Progressive cannot be operated when "Y, Pb, Pr" is selected on the VIDEO SOURCE SELECT menu. (See page 33)

Press the SELECT button to set the function "On" or "Off".

TABLE OF PICTURE IMAGE ADJUSTMENT

COLOUR	DECREASES	0	←→	63	INCREASES
TINT	MORE PURPLE	0	←→	63	MORE GREEN
WHITE BALANCE (R/G/B)	DECREASES	0	←→	63	INCREASES
CONTRAST	LIGHTER	0	←→	63	DEEPER
BRIGHTNESS	DARKER	0	←→	63	BRIGHTER
SHARPNESS	SOFTER	0	←→	31	SHARPER

PICTURE SCREEN ADJUSTMENT

This projector has a picture screen resize function, which enables you to display the image in desirable size.

WIDE function

This projector is able to project not only a normal video image (with 4 x 3 aspect ratio), but also a wider video image by compressing 4 x 3 image. This feature enable you to enjoy watching pictures like cinema images. You can switch either to WIDE or to REGULAR screen mode.

1. Press the MENU BUTTON and the MAIN MENU DISPLAY dialog box will appear.
2. Press the POINT LEFT/RIGHT BUTTON(s) to select SCREEN and press the SELECT BUTTON.
Another dialog box SCREEN ADJUST DISPLAY will appear.
3. Press the POINT DOWN BUTTON and a red arrow will appear.
4. To switch to "Wide" mode, move the arrow to Wide by pressing the POINT UP/DOWN BUTTON(s) and then press the SELECT BUTTON.
5. To switch to "Regular" mode, move the arrow to Regular by pressing the POINT UP/DOWN BUTTON(s) and then press the SELECT BUTTON.
6. When the image is distorted vertically, move the arrow to Keystone by pressing POINT UP/DOWN BUTTON(s) and then press SELECT BUTTON. The "Keystone" is displayed to indicate Keystone mode.
7. Press the POINT UP BUTTON to reduce the upper part of the image, and the POINT DOWN BUTTON to reduce the lower part. (See "KEystone FUNCTION" section on page 28).
8. Press the NORMAL BUTTON in keystone mode, the image changed to original image (not correct keystone distortion).

NOTE: The "WIDE" function cannot be operated when "Y, Pb, Pr" (except 480p) is selected on the VIDEO SOURCE SELECT menu. (See page 33).

MAIN MENU DISPLAY



COMPUTER MODE

COMPUTER SYSTEM SELECT

This projector is adjustable to different types of computer display signals based on VGA, SVGA, XGA or SXGA (See "COMPATIBLE COMPUTER SPECIFICATIONS" on the next page). If you set MODE SELECT to "COMPUTER", the projector will automatically process the incoming signal and projects the proper image without any special setting. Although this will work in most cases, you may be required to manually set the projector for some computer signals. If the computer image is not reproduced properly, try the following procedure and switch to the computer display mode that you want to use.

1. Connect the COMPUTER to the PROJECTOR and turn the projector on first.
2. Set MODE SELECT to "COMPUTER MODE (1 or 2)". This shows the current display mode initially detected by the projector in the system window. And "Current mode" display appears.

NOTE : 1. If the projector cannot discriminate or detect the input signal from the computer, the "Go PC adj." display appears.

NOTE : 2. If no input signal from the computer, the "No signal" display appears.

3. Press the MENU BUTTON and the MAIN MENU DISPLAY dialog box will appear.
4. Press the POINT LEFT/RIGHT BUTTON(S) to select SYSTEM and press the SELECT BUTTON. Another dialog box COMPUTER SYSTEM DISPLAY will appear.
5. Press the POINT DOWN BUTTON and a red arrow will appear.
6. If you want to change the current display mode, move the arrow by pressing the POINT UP/DOWN BUTTON(S) to select one of the modes.
7. Press the SELECT BUTTON to change the display mode.
8. To quit the MENU, move the arrow to Quit and then press the SELECT BUTTON.

MAIN MENU DISPLAY



COMPUTER SYSTEM DISPLAY

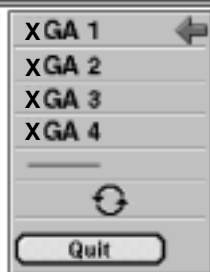

CURRENT MODE DISPLAY

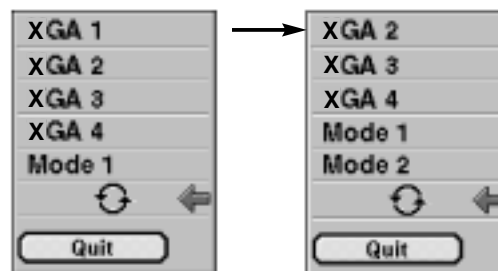
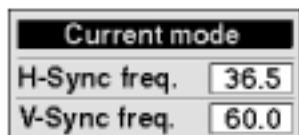

When the mark (⊙) is displayed as BLACK, computer system mode will be available on the next page. Move an arrow to the mark (⊙) and press the SELECT BUTTON to show computer system mode described on the next page.

PC ADJUSTMENT

This is a special function that may be used when a computer image is not reproduced properly. (See pages 41 ~ 44 for more detail.)

COMPATIBLE COMPUTER SPECIFICATIONS

ON-SCREEN DISPLAY	RESOLUTION	H-Freq. (kHz)	V-Freq. (Hz)
VGA1	640 x 480	31.47	59.88
VGA2	720 x 400	31.47	70.09
VGA3	640 x 400	31.47	70.09
VGA4	640 x 480	37.86	74.38
VGA5	640 x 480	37.86	72.81
VGA6	640 x 480	37.50	75.00
VGA7	640 x 480	43.269	85.00
Mac LC13	640 x 480	34.97	66.60
Mac13	640 x 480	35.00	66.67
RGB	—————	15.625	50.00 (Interlace)
RGB	—————	15.734	60.00 (Interlace)
SVGA1	800 x 600	35.156	56.25
SVGA2	800 x 600	37.88	60.32
SVGA3	800 x 600	46.875	75.00
SVGA4	800 x 600	53.674	85.06
SVGA5	800 x 600	48.08	72.19
SVGA6	800 x 600	37.90	61.03
SVGA7	800 x 600	34.50	55.38
SVGA8	800 x 600	38.00	60.51
SVGA9	800 x 600	38.60	60.31
SVGA10	800 x 600	32.70	51.09
SVGA11	800 x 600	38.00	60.51
Mac16	832 x 624	49.72	74.55
XGA1	1024 x 768	48.36	60.00
XGA2	1024 x 768	68.677	84.997
XGA3	1024 x 768	60.023	75.03
XGA4	1024 x 768	56.47	70.07
XGA5	1024 x 768	60.31	74.92
XGA6	1024 x 768	48.50	60.02
XGA7	1024 x 768	44.00	54.58
XGA8	1024 x 768	63.48	79.35
XGA9	1024 x 768	36.00	87.17 (Interlace)
XGA10	1024 x 768	62.04	77.07
XGA11	1024 x 768	61.00	75.70

ON-SCREEN DISPLAY	RESOLUTION	H-Freq. (kHz)	V-Freq. (Hz)
XGA12	1024 x 768	35.522	86.96 (Interlace)
XGA13	1024 x 768	46.90	58.20
XGA14	1024 x 768	47.00	58.30
XGA15	1024 x 768	58.03	72.00
Mac19	1024 x 768	60.24	75.08
SXGA1	1152 x 864	64.20	70.40
SXGA2	1280 x 1024	62.50	58.60
SXGA3	1280 x 1024	63.90	60.00
SXGA4	1280 x 1024	63.34	59.98
SXGA5	1280 x 1024	63.74	60.01
SXGA6	1280 x 1024	71.69	67.19
SXGA7	1280 x 1024	81.13	76.107
SXGA8	1280 x 1024	63.98	60.02
SXGA9	1280 x 1024	79.976	75.025
SXGA10	1280 x 960	60.00	60.00
SXGA11	1152 x 900	61.20	65.20
SXGA12	1152 x 900	71.40	75.60
SXGA13	1280 x 1024	50.00	86.00 (Interlace)
SXGA14	1280 x 1024	50.00	94.00 (Interlace)
SXGA15	1280 x 1024	63.37	60.01
SXGA16	1280 x 1024	76.97	72.00
SXGA17	1152 x 900	61.85	66.00
SXGA18	1280 x 1024	46.43	86.70 (Interlace)
SXGA19	1280 x 1024	63.79	60.18
SXGA20	1280 x 1024	91.146	85.024
Mac21	1152 x 870	68.68	75.06
Mac	1280 x 960	75.00	75.08
Mac	1280 x 1024	80.00	75.08
HDTV720p	—————	45.00	60.00
HDTV1035i	—————	33.75	60.00 (Interlace)
HDTV1080i	—————	33.75	60.00 (Interlace)

Specifications are subject to change without notice.

NOTE: Basically this projector can accept the signal from all computers with the above mentioned V, H-Frequency and less than 165 MHz of Dot Clock.

AUTO IMAGE FUNCTION

The Auto image function is provided to automatically adjust Fine sync., Total dots and Screen position for most computers.

NOTE: This AUTO IMAGE function cannot be operated when "RGB", "HDTV720p", "HDTV1035i" or "HDTV1080i" is selected on the COMPUTER SYSTEM SELECT menu. (See pages 36 ~ 37).

1. Press the MENU BUTTON and the MAIN MENU DISPLAY dialog box will appear.
2. Press the POINT LEFT/RIGHT BUTTON(s) to select AUTO IMAGE and press the SELECT BUTTON. Another dialog box AUTO IMAGE SETTING DISPLAY will appear.
3. Press the POINT DOWN BUTTON and a red arrow will appear.
4. Move the arrow to an item(s) you want to adjust by pressing the POINT UP/DOWN BUTTON(s).
5. Change the setting "On" , press the SELECT BUTTON.
6. Move the arrow by pressing the POINT UP/DOWN BUTTON(s) to select "Go!" and then press the SELECT BUTTON. The auto image function is started now. It will take about 10 seconds.
7. To store the settings, move the arrow to Stored and then press the SELECT BUTTON. When you have stored the settings, "OK?" is displayed for confirmation.
8. Move the arrow to "Yes" and then press the SELECT BUTTON. The stored settings are memorized even if the MAIN ON/OFF is switched off.
9. To quit the MENU, point to Quit and then press the SELECT BUTTON.
10. This setting is temporarily effective until you turn off the projector or change the input signal.

NOTE: The fine sync., total dots and screen position of some computers may not be fully adjusted with the "Auto Image Function." In that case, use the "Picture Image" and/or "Picture Position" adjustments (see pages 39 ~ 40) to make fine-adjust them after the "Auto Image Function" is executed.

MAIN MENU DISPLAY

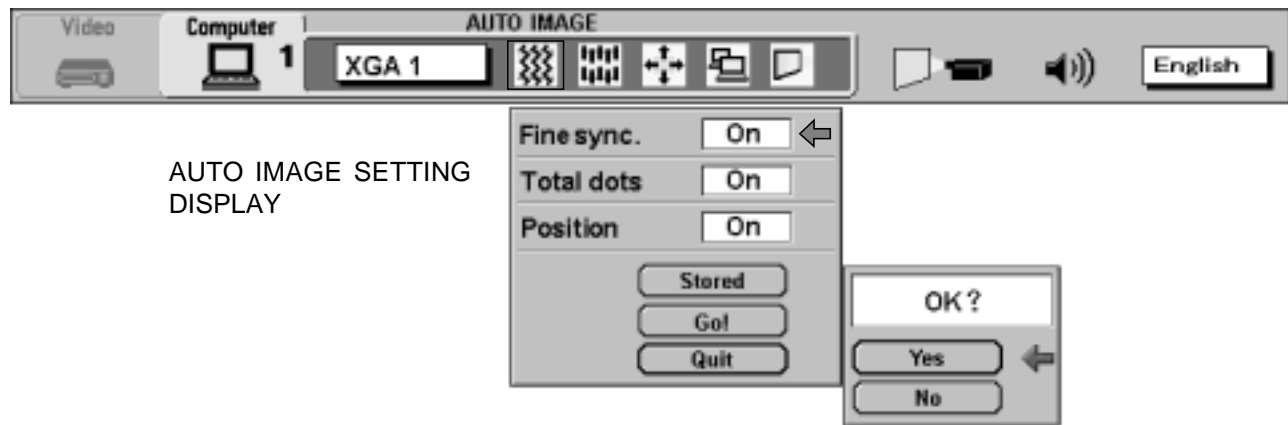

PICTURE IMAGE ADJUSTMENT

Picture adjustments have been preset at the factory. If you want to change the setting, operate the projector as follows.

1. Press the MENU BUTTON and the MAIN MENU DISPLAY dialog box will appear.
2. Press the POINT LEFT/RIGHT BUTTON(s) to select IMAGE and press the SELECT BUTTON. Another dialog box IMAGE ADJUST DISPLAY will appear. This shows the current picture settings.
3. In this dialog box, you can adjust the settings by increasing or decreasing the levels shown as numbers. The items and the range of the levels that you can adjust are summarized in the table below.
4. Press the POINT DOWN BUTTON and a red arrow will appear.
5. Move the arrow to an item that you want to adjust by pressing the POINT UP/DOWN BUTTON(s).
6. To increase the level, point the arrow to ▲ and then press the SELECT BUTTON. To decrease the level, point the arrow to ▼ and then press the SELECT BUTTON.
7. You may want to store the settings in the memory so that you can recall them later. To store the settings, move the arrow to Stored and then press the SELECT BUTTON. When you have stored the settings, "OK ?" is displayed for confirmation.
8. Move the arrow to Yes and then press the SELECT BUTTON. The stored settings are memorized even if the MAIN ON/OFF is switched off.
9. To quit the MENU, move the arrow to Quit and then press the SELECT BUTTON.
10. If you do not want to store the settings, move the arrow to Quit and then press the SELECT BUTTON. The settings changed remains effective until the MAIN ON/OFF switch is turned off.
11. To recall the settings from the memory that you have stored, move the arrow to Reset and then press the SELECT BUTTON. When you have reset the settings, "OK ?" is displayed for confirmation. Move the arrow to Yes and then press the SELECT BUTTON. You can adjust the settings again if needed.

NOTE: The "Fine sync." and "Total dots" cannot be fully adjusted when "RGB", "HDTV1035i" or "HDTV1080i" is selected on the COMPUTER SYSTEM SELECT menu. (See pages 36 ~ 37).

MAIN MENU DISPLAY

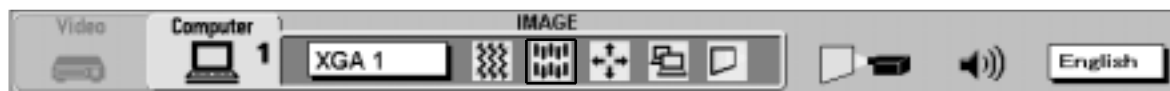

IMAGE ADJUST
DISPLAY

NOTE:

The projector may not reproduce a proper image for some SXGA signals.

Since SXGA (1280 x 1024) image is converted to 960 x 768 image by partial scan, some lines and dots of the image do not appear.

Some video noise of flicker on this compressed SXGA image cannot be eliminated even though you try to make a Fine sync adjustment.

TABLE OF PICTURE IMAGE ADJUSTMENT

FINE SYNC	Adjust the picture as necessary to eliminate flicker from the display.	0 ↔ 127
TOTAL DOTS	The number of the total dots in one horizontal period. Adjust the number to match your PC image.	
WHITE BALANCE (R/G/B)	DECREASE	0 ↔ 63 INCREASE
CONTRAST	LIGHTER	0 ↔ 63 DEEPER
BRIGHTNESS	DARKER	0 ↔ 63 BRIGHTER

PICTURE POSITION ADJUSTMENT

1. Press the MENU BUTTON and the MAIN MENU DISPLAY dialog box will appear.
2. Press the POINT LEFT/RIGHT BUTTON(s) to select POSITION and press the SELECT BUTTON. Another dialog box POSITION SETTING DISPLAY will appear.
3. Press the POINT DOWN BUTTON and a red arrow will appear.
4. Move the arrow to a desirable direction (← , → , ↑ or ↓) by pressing the POINT LEFT/RIGHT/UP/DOWN BUTTON(s) and press the SELECT BUTTON to a desirable picture position.
5. You may want to store the settings to the memory so that you can recall them later. To store the settings, move the arrow to Stored and then press the SELECT BUTTON. When you have stored the settings, "OK ?" is displayed for confirmation.
6. Move the arrow to Yes and then press the SELECT BUTTON. The stored settings are memorized even if the MAIN ON/OFF is switched off.
7. To quit the MENU, move the arrow to Quit and then press the SELECT BUTTON.
8. If you do not want to store the settings, move the arrow to Quit and then press the SELECT BUTTON. The settings changed remains effective until the MAIN ON/OFF switch is turned off.
9. To recall the settings from the memory that you have stored, move the arrow to Reset and then press the SELECT BUTTON. When you have reset the settings, "OK ?" is displayed for confirmation. Move the arrow to Yes and then press the SELECT BUTTON. You can adjust the settings again if needed.

MAIN MENU DISPLAY

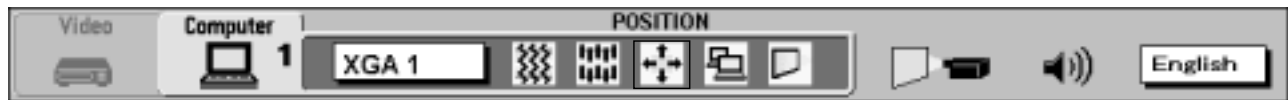

POSITION SETTING DISPLAY

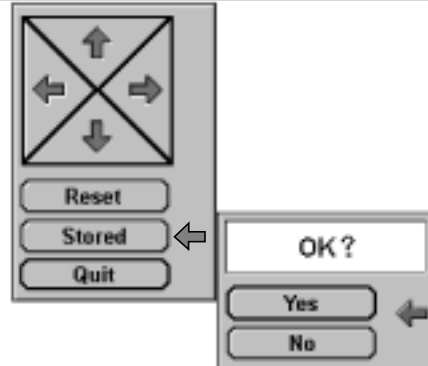

PC ADJUSTMENT

This projector can automatically detect display signals from most personal computers currently distributed. However, some computers employ a special signal format which is different from the standard one and the projector cannot detect it. If this happens, the projector cannot reproduce a proper image. And a flickering picture, a non-synchronized picture, a non-centered picture or a skewed picture may be projected instead.

For those non-standard formats, this projector is provided with PC ADJUST, enabling you to precisely adjust several parameters to match with the input signal format. The projector has eight independent memory areas where you can store the parameter you have set. This enables you to recall the setting for a specific computer when you need it.

NOTE: This PC ADJUSTMENT function cannot be operated when "RGB", "HDTV1035i" or "HDTV1080i" is selected on the COMPUTER SYSTEM SELECT menu. (See pages 36 ~ 37).

1. Press the MENU BUTTON and the MAIN MENU DISPLAY dialog box will appear.
2. Press the POINT LEFT/RIGHT BUTTON(s) to select PC ADJUST and press the SELECT BUTTON. Another dialog box "Where to reserve" will appear.
3. In this dialog box, you will select one of the memory areas from among "Mode 1" to "Mode 8". If parameters have been previously set and stored in the memory, the status "Stored" will appear on the corresponding row. If not, "Free" will appear.
4. Press the POINT DOWN BUTTON and a red arrow will appear.
5. Move the arrow to one of the "Modes" (Free position) where you want to store the parameters by pressing the POINT UP/DOWN BUTTON(s). Press the SELECT BUTTON to select it.

NOTE : If "Stored" appears in all Modes, no new PC parameter data can be stored. In this case, clear the PC parameter data using Mode free Function. (See page 44).

Continued to the next page.

MAIN MENU DISPLAY

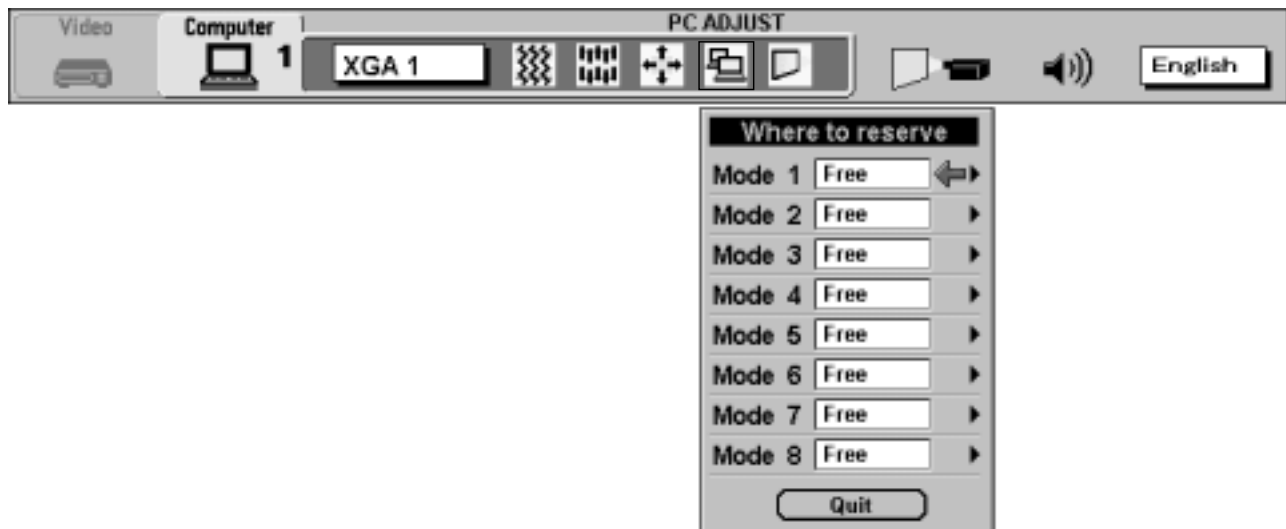

COMPUTER MODE

6. Another dialog box "PC ADJUSTMENT DISPLAY 1" will appear and the parameter data for the Mode you have selected is shown in this dialog box.
7. The parameters will be filled with the data determined by the projector according to the present signal input.
8. The function of the parameters and their values are summarized in the table as below.
9. Move the arrow to an item that you want to adjust by pressing the POINT UP/DOWN BUTTON(S).
10. To increase the level, point the arrow to ▲ and then press the SELECT BUTTON. To decrease the level, point the arrow to ▼ and then press the SELECT BUTTON.
11. If you want to store the settings in the memory, move the arrow to Stored and press the SELECT BUTTON. When you have stored the settings, "OK ?" is displayed for confirmation. Move the arrow to Yes and then press the SELECT BUTTON.
12. To recall the parameter data before setting, move the arrow to Reset and then press the SELECT BUTTON. When you have reset the settings, "OK ?" is displayed for confirmation. Move the arrow to Yes and then press the SELECT BUTTON. You can adjust the settings again if needed.
13. To quit the MENU, move the arrow to Quit and then press the SELECT BUTTON.
14. If you quit the MENU without storing the settings in the memory, the parameter data you changed will not be kept.
15. The stored settings are memorized even if the MAIN ON/OFF is switched off.
16. Adjust the data such as a "Clamp", "Fine sync", "Display area", "Horiz. scale" and "Vert. scale" if needed, move the arrow by pressing the POINT UP/DOWN BUTTON(S) to select (▼). Press the SELECT BUTTON.

Continued to the next page.

MAIN MENU DISPLAY

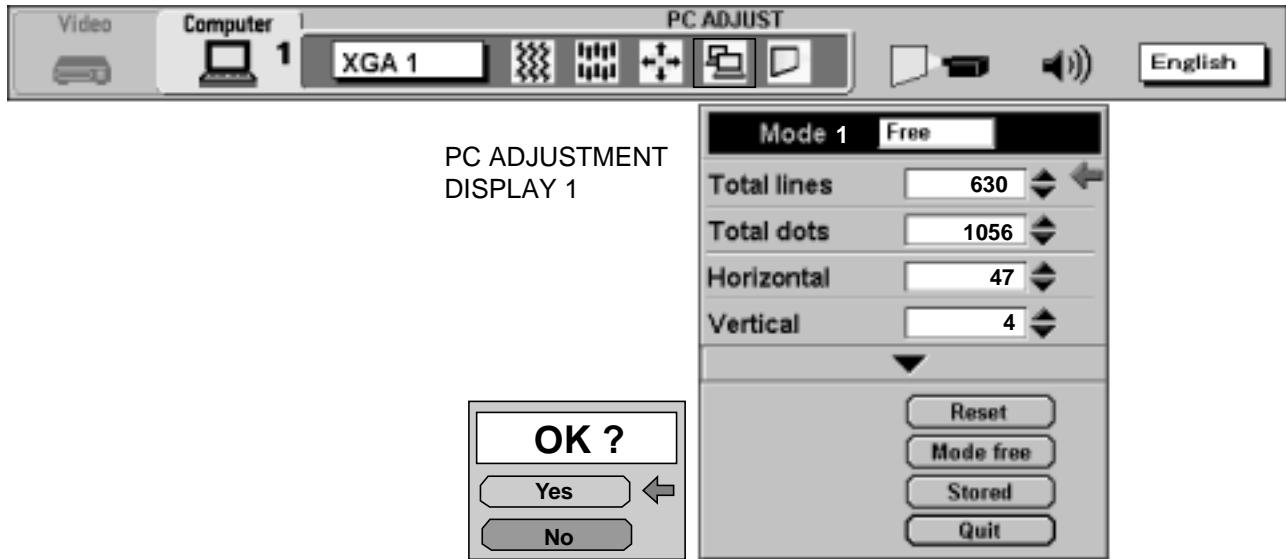

ITEM	FUNCTION
TOTAL LINES	The number of the total vertical lines. Adjust the number to match your PC image.
TOTAL DOTS	The number of the total dots in one horizontal period. Adjust the number to match your PC image.
HORIZONTAL	Adjustment of the horizontal picture position. When the image is not centered on the screen, adjust this.
VERTICAL	Adjustment of the vertical picture position. When the image is not centered on the screen, adjust this.

17. Another dialog box "PC ADJUSTMENT DISPLAY 2" will appear and the parameter data for the Mode you have selected is shown in this dialog box.
18. Move the arrow to an item that you want to adjust by pressing the POINT UP/DOWN BUTTON(s).
19. To increase the level, point the arrow to ▲ and then press the SELECT BUTTON. To decrease the level, point the arrow to ▼ and then press the SELECT BUTTON.
20. If you want to store the settings in the memory, move the arrow to Stored and press the SELECT BUTTON. When you have stored the settings, "OK ?" is displayed for confirmation. Move the arrow to Yes and then press the SELECT BUTTON.
21. To recall the parameter data before setting, move the arrow to Reset and then press the SELECT BUTTON. When you have reset the settings, "OK ?" is displayed for confirmation. Move the arrow to Yes and then press the SELECT BUTTON. You can adjust the settings again if needed.
22. To quit the MENU, move the arrow to Quit and then press the SELECT BUTTON.
23. If you quit the MENU without storing the settings in the memory, the parameter data you changed will not be kept.
24. The stored settings are memorized even if the MAIN ON/OFF is switched off.

MAIN MENU DISPLAY

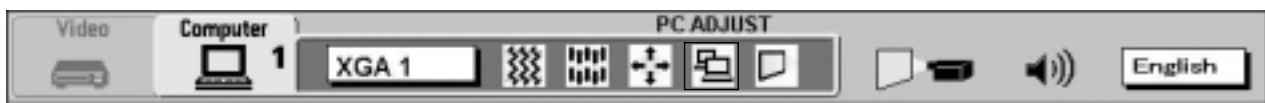

NOTE: The "Display area", "Horiz. scale" and " Vert. scale" cannot be adjusted when "HDTV1035i" or "HDTV1080i" is selected on the COMPUTER SYSTEM SELECT menu. (See pages 36 ~ 37).

1. To adjust the display area, move the arrow by pressing the POINT UP/DOWN BUTTON(s) to select (▶) and press the SELECT BUTTON.
2. Another dialog box "DISPLAY AREA DISPLAY" will appear.
3. Move the arrow to an item that you want to select display area by pressing the POINT UP/DOWN BUTTON(s) and press the SELECT BUTTON. Selected mode data will be displayed in H, V box.
4. To close dialog, move the arrow to "Quit" and press the SELECT BUTTON.

ITEM	FUNCTION
CLAMP	Adjustment of the clamp level. When the image has a dark bar, try this adjustment.
FINE SYNC	Adjust the picture as necessary to eliminate flicker from the display.
DISPLAY AREA	Adjustment the display area to match your PC.
HORIZ. SCALE	Expanding or compressing level for the horizontal direction.
VERT. SCALE	Expanding or compressing level for the vertical direction.

COMPUTER MODE

MODE FREE

The Mode free function is provided to confirm or clear the parameter data produced by PC ADJUST.

1. Press the MENU BUTTON and the MAIN MENU DISPLAY dialog box will appear.
2. Press the POINT LEFT/RIGHT BUTTON(s) to select PC ADJUST and press the SELECT BUTTON. Another dialog box "Where to reserve" will appear.
3. Press the POINT DOWN BUTTON and a red arrow will appear.
4. Move the arrow to one of the "Modes" (Stored position) that you want to confirm by pressing the POINT UP/DOWN BUTTON(s). Press the SELECT BUTTON. Another dialog box "PC ADJUSTMENT DISPLAY" will appear.
5. To quit the MENU, point to Quit and then press the SELECT BUTTON.
6. To modify the parameter data, perform the steps 9 ~ 24 of PC ADJUSTMENT SECTION.
7. To clear the parameter data, move the arrow by pressing the POINT UP/DOWN BUTTON(s) to select Mode free. Press the SELECT BUTTON. "OK?" is displayed for confirmation.
8. Move the arrow to Yes and then press the SELECT BUTTON to clear the parameter data.
9. To quit the MENU, move the arrow to Quit and then press the SELECT BUTTON.

MAIN MENU DISPLAY

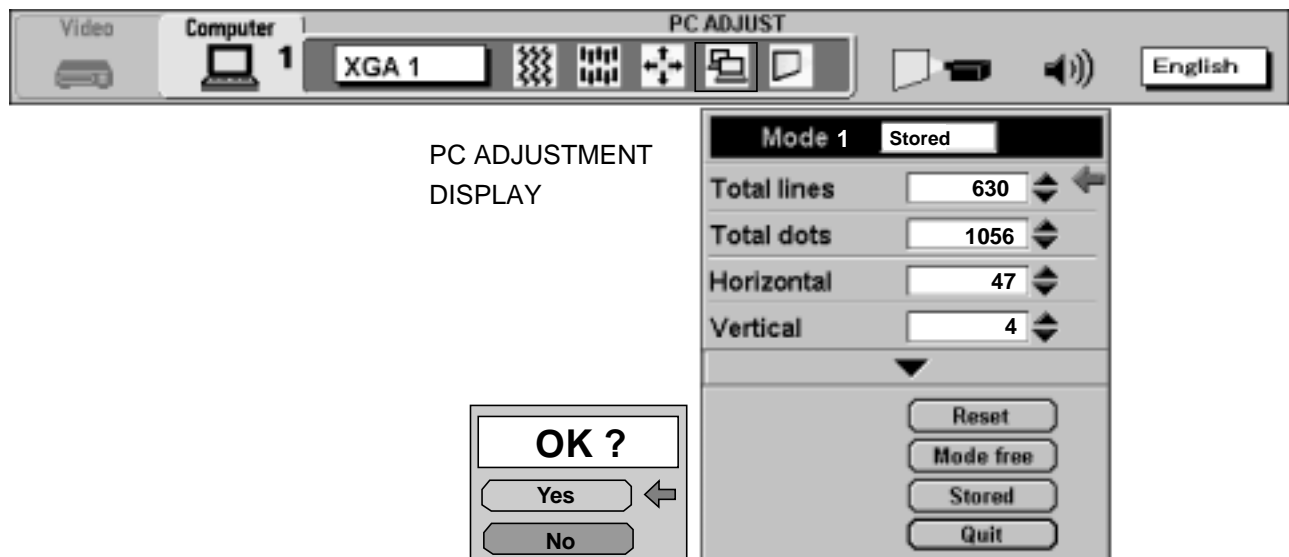
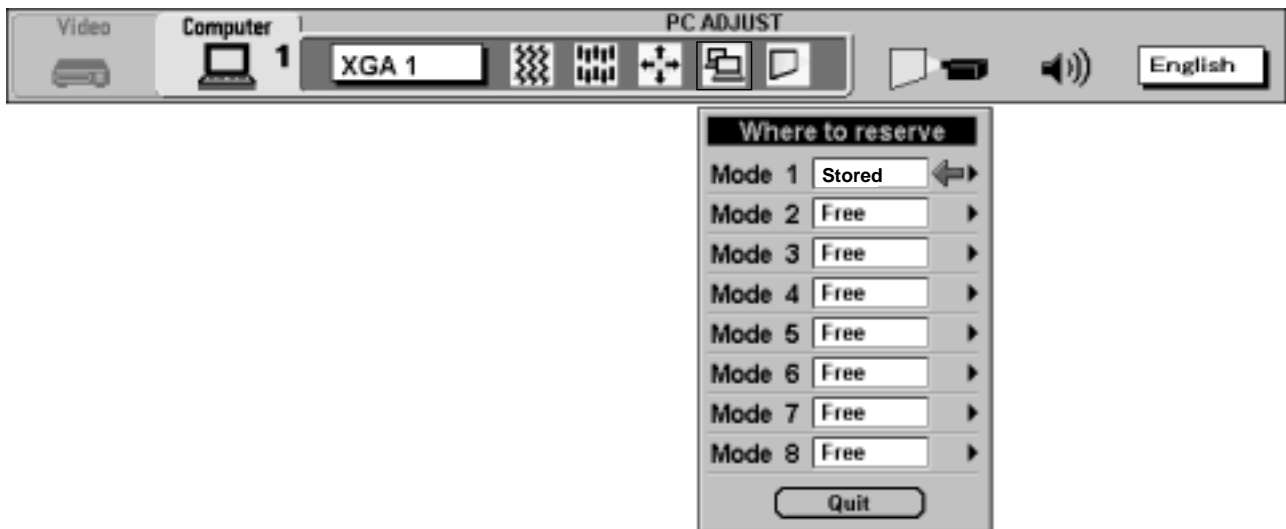

PICTURE SCREEN ADJUSTMENT

This projector has a picture screen resize function, which enables you to display the image in desirable size.

1. Press MENU BUTTON and MAIN MENU DISPLAY dialog box will appear.
2. Press POINT LEFT/RIGHT BUTTON(s) to select SCREEN and press the SELECT BUTTON. Another dialog box SCREEN ADJUST DISPLAY will appear.
3. Press POINT DOWN BUTTON and a red arrow will appear.
4. Move the arrow to the function that you want to adjust.

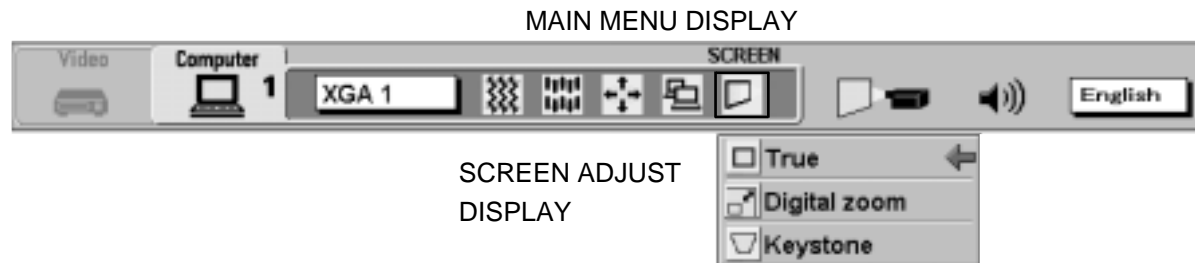

True

1. To turn the image size to true size (1280 x 1024 in SXGA, 1024 x 768 in XGA, 800 x 600 in SVGA and 640 x 480 in VGA), move the arrow to True by pressing POINT UP/DOWN BUTTON(s) and then press SELECT BUTTON. The image size is turned to the true size. The "True" is displayed to indicate True mode (except for XGA input).
2. When the input image data resolution is more than the screen size (1024 x 768), the image can be panned by pressing the POINT UP/DOWN/LEFT/RIGHT (POINTING PAD) BUTTON(s).

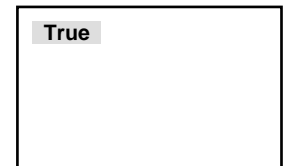

Digital zoom

1. To adjust the image size or pan the image, move the arrow to Digital zoom by pressing POINT UP/DOWN BUTTON(s) and then press SELECT BUTTON. MAIN MENU DISPLAY and SCREEN ADJUST DISPLAY will disappear and "D. Zoom" and the magnifying-glass icon is displayed.
2. Move the magnifying-glass icon by pressing the POINT UP/DOWN/LEFT/RIGHT (POINTING PAD) BUTTON(s).
3. To expand the image, press the D.ZOOM (▲) button or the SELECT button on the remote control unit. The image is magnified by degrees (Expand function).
4. To compress the image size, press the D.ZOOM (▼) button or the FRONT CLICK button on the remote control unit. The size of image is reduced by degrees (Compress function).
5. To pan the image, press POINT UP/DOWN/LEFT/RIGHT (POINTING PAD) BUTTON(s) and move the magnifying-glass icon.

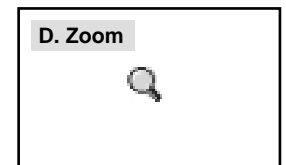

NOTE:

1. To cancel the True and Digital Zoom mode, press other buttons (Except NORMAL BUTTON).
 2. Press the NORMAL BUTTON in True and Digital Zoom mode, the image size changed to the screen size (1024 x 768).
 3. The "True" and "Digital zoom" cannot be operated when "RGB", "HDTV1035i" or "HDTV1080i" is selected on the COMPUTER SYSTEM SELECT menu. (See pages 36 ~ 37).
- This projector cannot display in the resolution more than 1280 x 1024. If your computer's screen resolution is higher than 1280 x 1024, reset the resolution to the lower.
 - The image data of VGA (640 x 480), SVGA (800 x 600), or SXGA (1280 x 1024) is modified to fit the screen size in the initial mode.
 - The maximum size in expand mode is 7 times as large as the original screen size.
 - The minimum size in compress mode is the screen size (1024 x 768) in XGA or SXGA mode, 800 x 600 in SVGA mode or 640 x 480 in VGA mode.
 - Panning function can work only when the image is expanded.
 - The normal "Panning Operation" may not function properly if the computer system prepared with the "PC Adjust" is used.

Keystone

1. When the image is distorted vertically, move the arrow to Keystone by pressing POINT UP/DOWN BUTTON(s) and then press SELECT BUTTON. The "Keystone" is displayed to indicate Keystone mode.
2. Press the POINT UP BUTTON to reduce the upper part of the image, and the POINT DOWN BUTTON to reduce the lower part. (See "KEYSTONE FUNCTION" section on page 28).
3. Press the NORMAL BUTTON in keystone mode, the image changed to original image (not correct keystone distortion).

OTHER FUNCTION SETTING

This projector has other functions settings: Blue back, Display, Ceiling, Rear, Split wipe, Power management, Remote control and Lamp age.

See the next page menus figure and settings.

BLUE BACK (On or Off)

When this function is in the "On" position, the projector will project a blue image without video noise on the screen when the video source is unplugged or turned off.

DISPLAY (On 1, On 2 or Off)

When this function is in the "On 1" position, on-screen displays always appears when adjustments are made. Although these on-screen displays are very helpful, these may spoil the view if adjustments are made during presentations. To avoid this, you can keep back certain displays by switching the function "On 2" and "Off". The followings are the displays that you can hide.

"On 2" position

- Wait Display (Start up Logo)

"Off" position

- | | | |
|---|----------------------|-------------------|
| ● Wait Display (Start up Logo and count-down timer) | ● Mode Display | ● Volume Display |
| ● Mute Display | ● Zoom/Focus Display | ● True Display |
| ● D.Zoom Display | ● Keystone Display | ● No show Display |
| ● Normal Display | | |

CEILING (On or Off)

When this function is in the "On" position, the top/bottom and the left/right picture reverse capability lets you project from a ceiling-mounted projector.

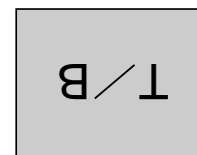
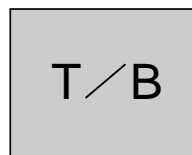

REAR (On or Off)

When this function is in the "On" position, the left/right picture reverse capability lets you project onto a rear projection screen.

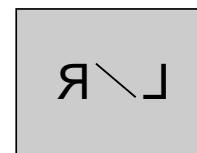
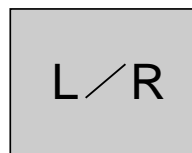

SPLIT WIPE (On or Off)

Turn SPLIT WIPE function On in the SETTING menu. The picture will change into the next one by sliding black image side ways when the input source is changed.

Change the input source by MODE button. The picture is replaced by black image from side ways to the center, and the next one appears from the center to side ways like drawing the black curtains.

POWER MANAGEMENT (On or Off)

This function turns the Projection Lamp off when the projector detects signal interruption and the projector is not used for a certain period in order to reduce power consumption and maintain the Lamp-life. (This projector is shipped with this function ON.) Power Management function operates to turn the Projection Lamp off when the input signal is interrupted and the projector is not operated over 5 minutes. This function operates as follows:

1. When the signal is interrupted, "No signal" and the counting down (5 minutes) display appears.
2. After 5 minutes, the Projection Lamp turned off and the READY indicator turns off. After 1 minutes, the READY indicator flashes and the Lamp can be turned on again (Power Management mode). In this Power Management mode, the Projection Lamp is automatically turned on when the input signal connected or the projector is operated with any button on the Top Control or the Remote Control.

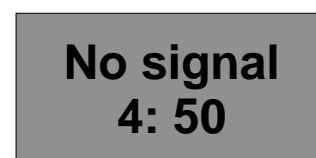

↑
Time left until Lamp off.

REMOTE CONTROL CODE CHANGE (Mode 1 or Mode 2)

This projector can be operated with two different code, one is factory-set normal code (MODE 1) and the other one is extended code (MODE 2).

This is used to prevent the remote control operation mixture (jam) when two projector and several remote control video equipments are system-up and used together.

When you change the code MODE 2, you must change both projector and Remote Control Unit.

To change Projector code:

Set REMOTE CONTROL in SETTING menu (below figure) to "MODE 2".

To change Remote Control Unit code:

Press both "MENU" and "NORMAL" button on the Remote Control Unit for over 10 seconds.

After code changed, make sure the Remote Control operation is functioning properly. To go back to normal code (MODE 1), take same operation above.

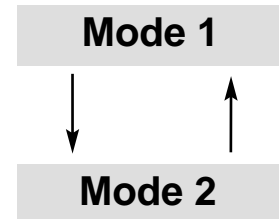

Setting the Blue back, Display, Ceiling, Rear, Split wipe, Power management and Remote control

1. Press the MENU BUTTON and the MAIN MENU DISPLAY dialog box will appear.
2. Press the POINT LEFT/RIGHT BUTTON(s) to select SETTING and press the SELECT BUTTON. Another dialog box SETTING DISPLAY will appear.
3. Press the POINT DOWN BUTTON and a red arrow will appear.
4. Move the arrow to an item you want to set by pressing the POINT UP/DOWN BUTTON(s).
5. If you want to change the setting, press the SELECT BUTTON.
6. To quit the MENU, point to Quit and then press the SELECT BUTTON.
7. The settings are memorized even if the MAIN ON/OFF is switched off.

MAIN MENU DISPLAY

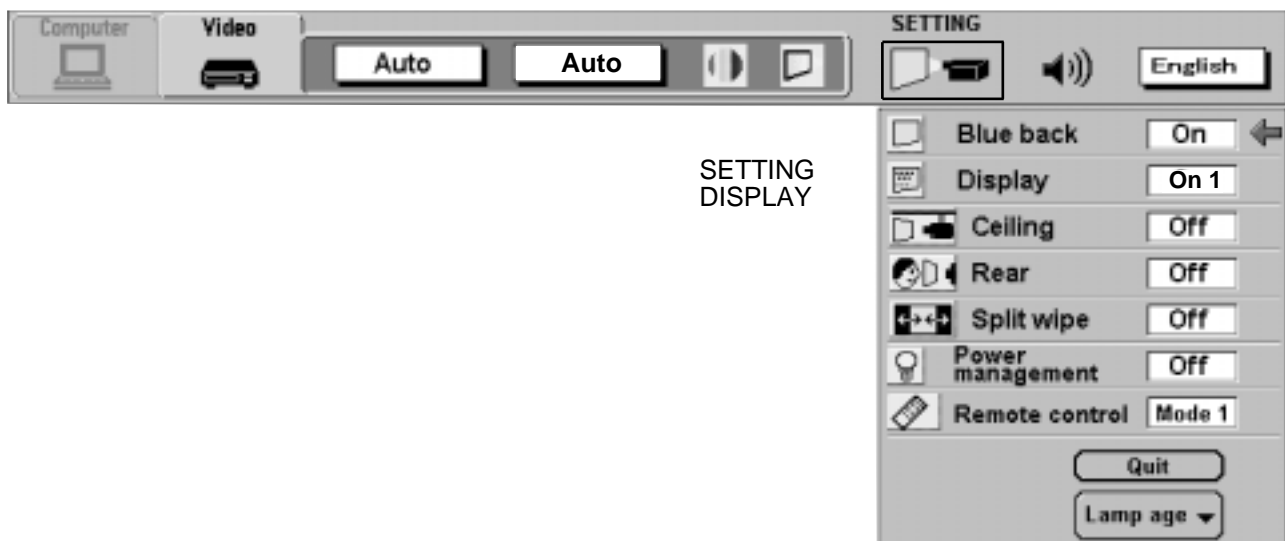

LAMP AGE

The Lamp age function is designed to reset the lamp replacement monitor timer. When replacing the lamp, reset the lamp replacement monitor timer by using this function.

NOTE: Do not reset the LAMP REPLACEMENT MONITOR TIMER, except after the lamp is replaced.

1. Press the MENU BUTTON and the MAIN MENU DISPLAY dialog box will appear.
2. Press the POINT LEFT/RIGHT BUTTON(s) to select SETTING and press the SELECT BUTTON.
Another dialog box SETTING DISPLAY will appear.
3. Press the POINT DOWN BUTTON and a red arrow will appear.
4. Move the arrow by pressing the POINT UP/DOWN BUTTON(s) to select Lamp age and then press the SELECT BUTTON. When you reset the lamp replace monitor, "lamp replace monitor reset?" is displayed for confirmation.
5. Move the arrow to Yes and then press the SELECT BUTTON, "OK?" is displayed for confirmation.
Move the arrow to Yes and then press the SELECT BUTTON, the lamp replace monitor is reset.
6. Move the arrow to No and then press the SELECT BUTTON. The lamp replace monitor is not reset.
7. To quit the MENU, move the arrow to Quit and then press the SELECT BUTTON.

MAIN MENU DISPLAY

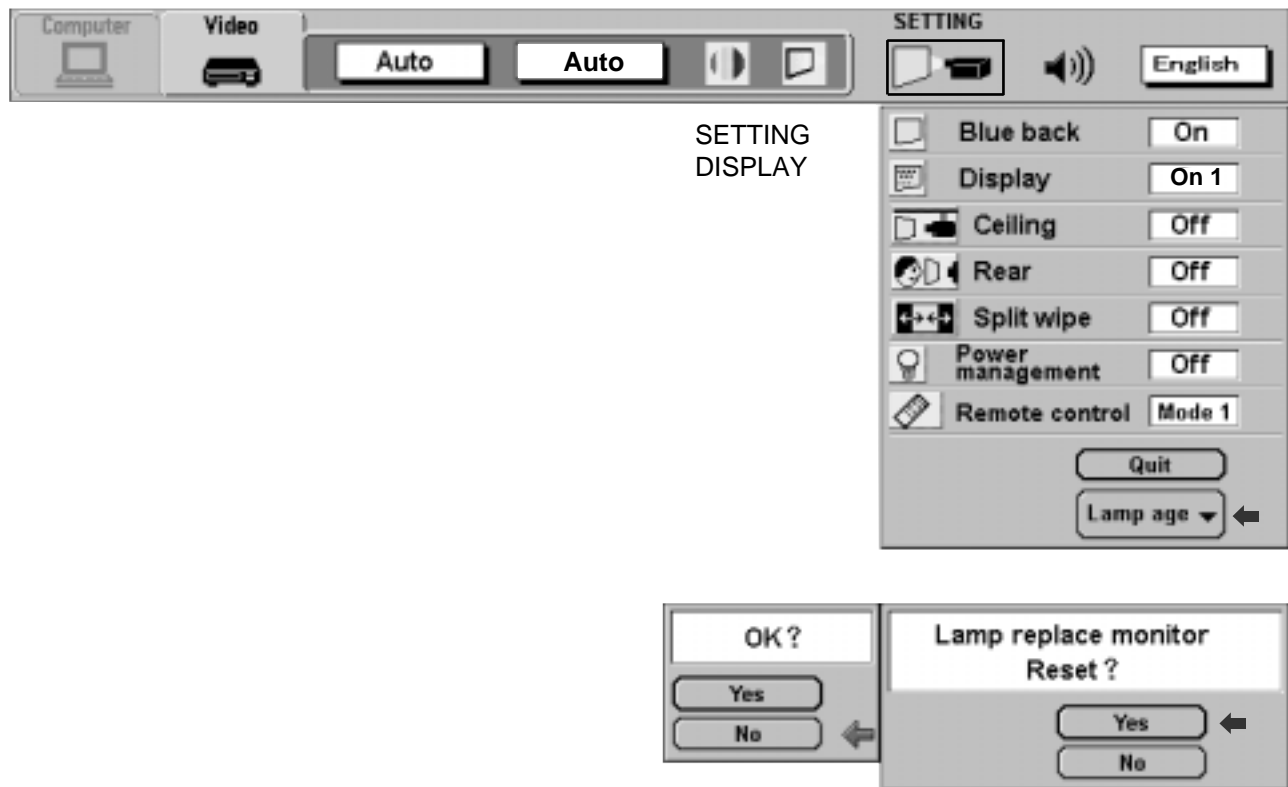

APPENDIX

MAINTENANCE

TEMPERATURE WARNING INDICATOR

The TEMPERATURE WARNING INDICATOR flashes red when the internal temperature of the projector exceeds the normal temperature.

Possible causes for the temperature warning may be:

1. Ventilation slots of the projector are blocked. In such an event, reposition the projector so that ventilation slots are not obstructed.
2. Air filter is clogged with dust particles. Remove dust from the air filter by following instructions in the Air Filter Care and Cleaning section below.
3. If temperature warning indicator remains on after performing the checks listed above, cooling fan/internal circuits may be malfunctioning. Request service from an authorized dealer or service station.

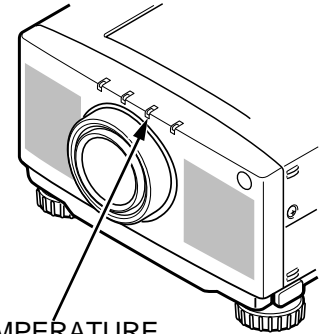

TEMPERATURE
WARNING
INDICATOR

AIR FILTER CARE AND CLEANING

The removable air filter prevents dust from accumulating on the surface of the projection lens and projection mirror. Should the air filter become clogged with dust particles, it will reduce the cooling fan's effectiveness and may result in internal heat build up and reduce the life of the projector.

To clean the air filter, follow the cleaning procedures below:

1. Turn the POWER ON/OFF button OFF.
2. Remove the air filter cover.
3. Remove the air filter from the filter cover.
4. Clean the air filter with a vacuum cleaner.
5. Replace the air filter. Make sure that air filter cover is fully inserted.

AIR FILTER
COVER

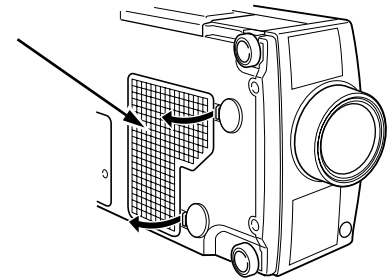

AIR FILTER

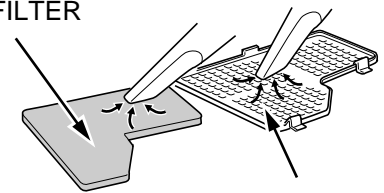

AIR FILTER
COVER



Do not clean with water. Doing so may damage the air filter.
Do not operate the projector with air filter removed.

RECOMMENDATION

TO ENJOY PICTURE IMAGE, USE THE PROJECTOR IN THE CLEAN ENVIRONMENT. USAGE IN THE CLEAN ENVIRONMENT IS RECOMMENDED.

When used under the dusty or smoky conditions, dust may accumulate on the liquid crystal panel and lens inside it, and may resultantly be projected on the screen together with the picture.

When the above symptoms are noticed contact the place where your authorized dealer or service station for the cleaning.

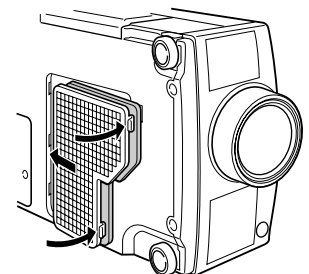

LAMP REPLACEMENT

If the lamp fails to come on and the lamp monitor on the projector light is orange, you must replace the lamp.



- For continued safety, replace with a lamp assembly of the same type.
- Allow the projector to cool for at least 45 minutes before you open the lamp cover. The inside of the projector can become very hot.
- Do not drop the lamp module or touch the glass bulb ! The glass can shatter and cause injury.

Follow these steps to replace the lamp assembly.

1. Turn off the projector and allow the projector to cool thoroughly.
2. Disconnect the AC cord from the projector.
3. Remove screw with a screwdriver and remove the lamp cover.
4. Remove 2 screws with a screwdriver and pull out the lamp assembly by grasping the handle.
5. Replace the lamp assembly.
6. Tighten 3 screws to secure the lamp cover and the lamp assembly.
7. Connect the detachable AC cord to the projector.
8. Reset the lamp replacement monitor timer.
(See "LAMP AGE" section on page 48.)

NOTE: Do not reset the LAMP REPLACEMENT MONITOR TIMER, except after the lamp is replaced.

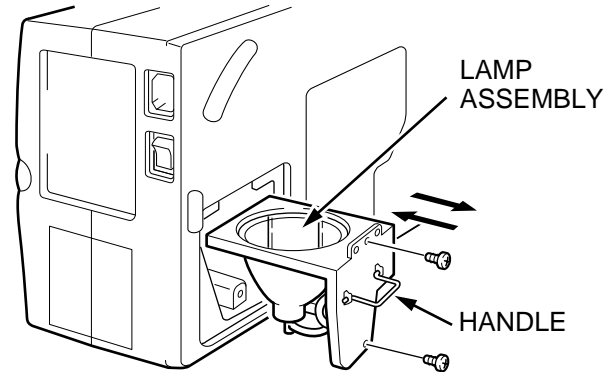
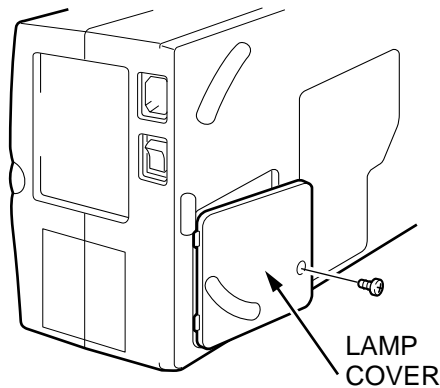
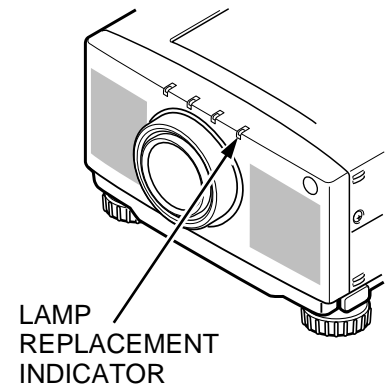

ORDER REPLACEMENT LAMP

Replacement Lamp can be ordered through your dealer. When ordering the Lamp, give the following information to the dealer.

- Model No. of your projector : PLC-XP21E/XP21/XP18E/XP18
- Replacement Lamp Type No. : POA-LMP24
(Service Parts No. 610 282 2755)

CLEANING THE LENS

Follow these steps to clean the projection lens:

1. Apply a non-abrasive camera lens cleaner to a soft, dry cleaning cloth.
Avoid using an excessive amount of cleaner.
Abrasive cleaners, solvents or other harsh chemicals might scratch the lens.
2. Lightly wipe the cleaning cloth over the lens.
3. When you are not using the projector, replace the lens cover.

TROUBLESHOOTING

Before calling your dealer or service station for assistance, check the items below once again.

1. Make sure you have connected the projector to your equipment as described in section "CONNECTING THE PROJECTOR" on pages 11 ~ 18.
2. Check cable connections. Verify that all computer, video and power cords are properly connected.
3. Verify that power is switched on.
4. If the projector still does not display an image, re-start the computer.
5. If the image still does not display, unplug the projector from the computer and check the computer monitor's display.
The problem may be with your graphics controller rather than with the projector. (When you reconnect the projector, remember to turn the computer and monitor off before you power up the projector. Power the equipment back up in order of: Projector and computer)
6. If the problem still exists, check the following chart.

Problem:	Try these Solutions:
No power.	<ul style="list-style-type: none"> ● Plug the projector into an AC outlet. ● Turn the MAIN ON/OFF switch to ON. ● Press the POWER ON/OFF switch to ON. ● Be sure the READY INDICATOR light is ON. ● Wait approximate 1 minute after the projector is turned OFF before turning the projector back on. <p>NOTE: After pressing the POWER ON/OFF button to OFF. The projector functions as indicated.</p> <ol style="list-style-type: none"> 1. The LAMP POWER indicator will light and the READY indicator will turn off. 2. After approximate 1 minute, the READY indicator will light green again and the projector may be turned on by pressing the POWER ON/OFF button. <ul style="list-style-type: none"> ● Check temperature warning indicator. If the indicator flashes red, the projector cannot be turned on. (See "BASIC OPERATION" section on page 27). ● Check the projection lamp. ● Replace the lamp cover. (Check the interlock switch inside of the lamp cover.)
Image is out of focus.	<ul style="list-style-type: none"> ● Adjust the focus. ● Make sure the projection screen is at least 1.4 m from the projector. ● Check the projection lens to see if it needs cleaning. <p>NOTE: Moving the projector from a cool temperature location to a warm temperature location may result in moisture condensation on the lens. In such an event, leave the projector OFF and wait until condensation disappears.</p>

Problem:	Try these Solutions:
Picture is L/R Reversed.	Check Ceiling/Rear feature. (See "OTHER FUNCTION SETTING" section on pages 46 ~ 47).
Picture is T/B inverted.	Check Ceiling feature. (See "OTHER FUNCTION SETTING" section on pages 46 ~ 47).
Some displays are not seen during the operation.	Check Display feature. (See "OTHER FUNCTION SETTING" section on pages 46 ~ 47).
No sound.	<ul style="list-style-type: none"> ● Check audio cable connection from audio input source. ● Adjust audio source. ● Press the VOLUME (+) button. ● Press the MUTE button.
Remote control unit does not work.	<ul style="list-style-type: none"> ● Check the batteries. ● Make sure nothing is blocking between the remote control sensor and remote control unit. ● Make sure you are not too far from the projector when using the remote control unit. (Maximum operate range 5 m). ● Check the ALL-OFF switch on the Remote Control Unit is set to "ON". ● Check the transmitted signal mode from the remote control unit. (See "OTHER FUNCTION SETTING" section on pages 46 ~ 47).
Wireless mouse function does not work.	<ul style="list-style-type: none"> ● Check the cable connection between the projector and the computer. ● Check the mouse setting on your computer. ● Turn on the projector before you turn on the computer.

TECHNICAL SPECIFICATIONS

Projector Type	Multi-media Projector
Dimensions (W x H x D)	272 mm x 145.5 mm x 412.5 mm
Net Weight	6.9 kg
LCD Panel System	1.3" TFT Active Matrix type x 3 panels
Number of Pixels	2,359,296 {786,432 (1,024 x 768) x 3}
Colour System	6 colour system (PAL, SECAM, NTSC, NTSC4.43, PAL-M and PAL-N)
Scanning Frequency	H-sync. 15 ~ 100 KHz, V-sync. 50 ~ 100 Hz
Projection Image Size (Diagonal)	Adjustable from 31" to 400"
Horizontal Resolution	800 TV lines
Projection Lens	F1.8 ~ 2.1 lens with f=48.4 mm ~ 62.8 mm Motor zoom and focus
Throw Distance	1.4 m ~ 14.4 m
Projection Lamp	200 watt type
AV Input Jacks	PHONO Type 3 x 2 sets (Video, Audio R and L), (Y, Cb/Pb, Cr/Pr) and DIN 4 pin (S-Video) x 1
Computer Input Jacks	(VGA) HDB 15 Terminal x 2, DIN 8 pin (Control port) x 2
Computer Output Jack	(VGA) HDB 15 Terminal
Computer Audio Input Jacks	Mini Stereo Type x 2
Other Jack	EXT. Speaker Jack (Stereo) x 1
Built-in Speaker	INT. SP. Stereo (R and L), 2 watt RMS (T.H.D.10%)
Image Elevation Adjustment	Up to 6 °
Voltage	200 ~ 240 V AC, 50/60 Hz (Model PLC-XP21E/XP18E) 110 ~ 120 V AC, 50/60 Hz (Model PLC-XP21/XP18)
Power Consumption	1.8 A (Max. Ampere) Model PLC-XP21E/XP18E 3.6 A (Max. Ampere) Model PLC-XP21/XP18
Operating Temperature	5°C ~ 35°C (41°F ~ 95°F)
Storage Temperature	-10°C ~ 60°C (14°F ~ 140°F)
Remote Control Transmitters	Wireless Remote Control with Laser Beam (Class II Laser) Max. Output 1mW/Wave Length 650 ± 20nm, batteries (2) AA, UM3 or R06 type.

Printed in Japan
Part No. 610 287 2767 (1AA6P1P2377-- PF6AF)



SANYO Electric Co., Ltd