

SANYO

INSTRUCTION MANUAL

C29ZK80

Colour Television

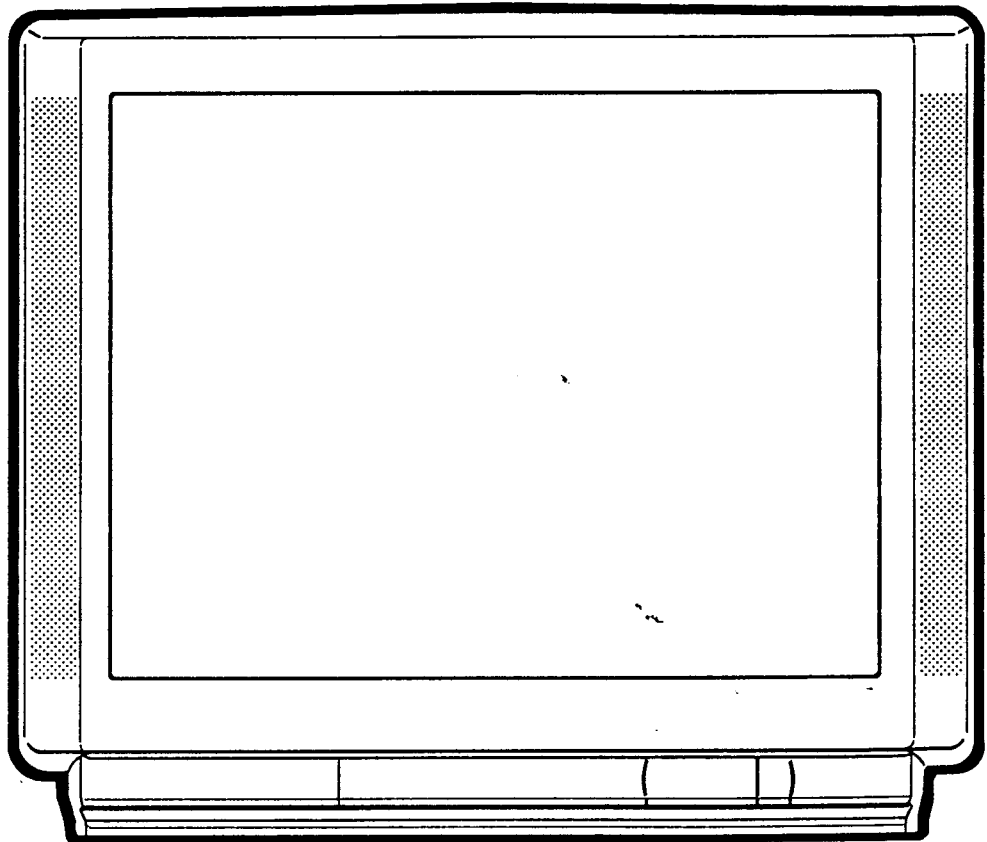

Remote Control
Video Multi Terminal (PAL/NTSC/NTSC4.43)
Blue Back Function on AV mode

Contents

Electric Mains.....	2
Battery installation of the Remote Control Transmitter.....	2
Warnings and Cautions	3
Controls / Remote Control Transmitter.....	5
General Operation	
Power ON/OFF, Programme Selection(Direct Selection)...	6
Programme Selection(Programme UP and Down).....	7
Volume Control, Recall, Alternate.....	7
Sound Mute, OFF Timer, Memory, Normalization.....	8
Picture Adjustments.....	9
Tuning of the Channels	
Automatic Tuning, Channel Copy.....	10
Semi-Auto Tuning, Manual Tuning.....	11
Setting Restricted Programmes.....	12
Maximum volume level setting and suppression of channel tuning.....	13
Connecting other Equipment	
Connecting to the AV Input Jacks.....	14
Connecting to the AV Output Jacks.....	14
To record a TV broadcast while watching the playback from a VCR.....	15
AV Connection to the Aerial Socket.....	15
Aerial Connection.....	16
Specifications.....	16

Electric Mains

The receiver designed to operate on an A.C. mains supply of 220 – 240 Volts, 50Hz.

Battery Installation of the Remote Control Transmitter

- 1 Remove the battery cover by sliding.
- 2 Install two "AA" 1.5 volt batteries so that the "+" and "-" marks on the batteries match the "+" and "-" marks inside the unit.
- 3 Close the battery cover.

Note: Replace the batteries when the TV set is showing the following symptoms:

Operation is unsteady or erratic, sometimes the TV set does not work with transmitter.

Discharged batteries may leak and damage the unit.

The normal life of batteries should be from nine to ten months.

Warnings and Cautions

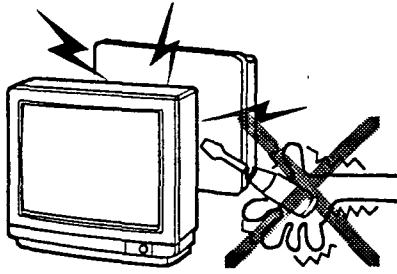

Warning

High voltages are used in the operation of this television receiver. Do not remove the cabinet back from your set. Refer servicing to qualified service personnel.

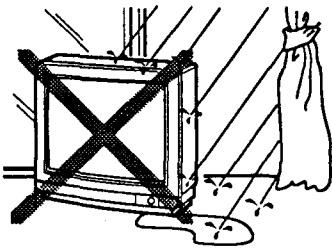

Warning

To prevent fire or electrical shock hazard, do not expose the television receiver to rain or moisture.

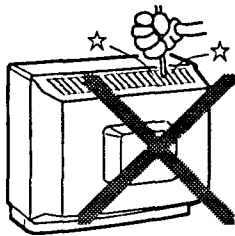

Warning

Do not drop or push objects into the television cabinet slots or openings. Never spill any kind of liquid on the television receiver.

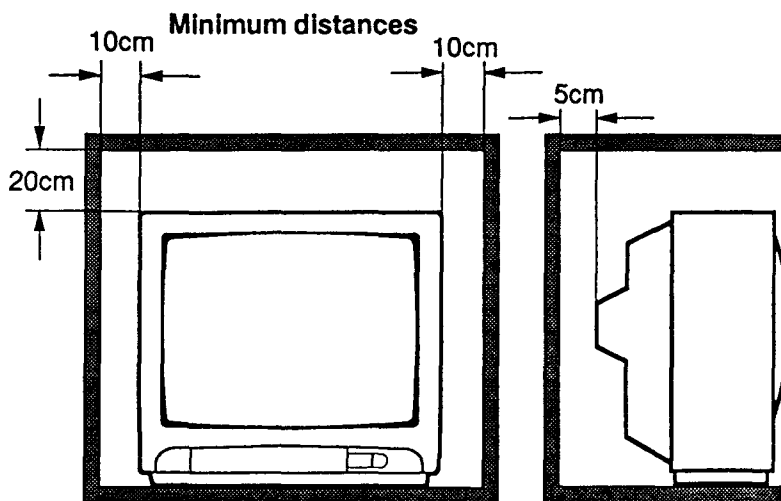

Caution

If the television is to be built into a compartment or similarly enclosed, the minimum distances must be maintained. Heat build-up can reduce the service life of your television, and can also be dangerous.

Warnings and Cautions

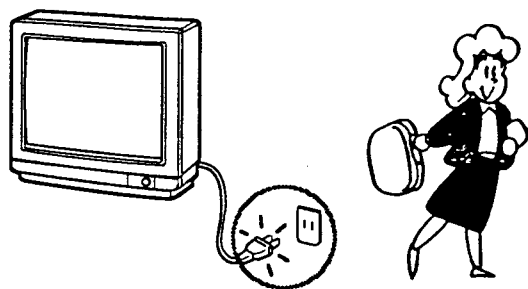

Caution

When the television receiver is not used for an extended period of time, it is advisable to disconnect the AC power cord from the AC outlet.

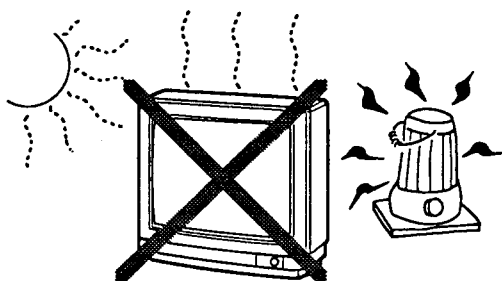

Caution

Avoid exposing the television receiver to direct sunlight and other source of heat.
Do not stand the television receiver directly on other products which give off heat. E.g. video cassette players, audio amplifiers.

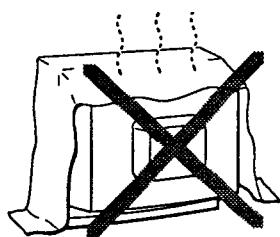

Caution

Do not block the ventilation holes in the back cover.
Adequate ventilation is essential to prevent failure of electrical components.

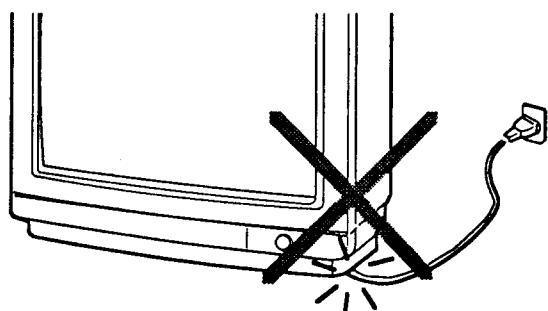

Caution

Do not squash power supply cord under the television receiver.

Controls

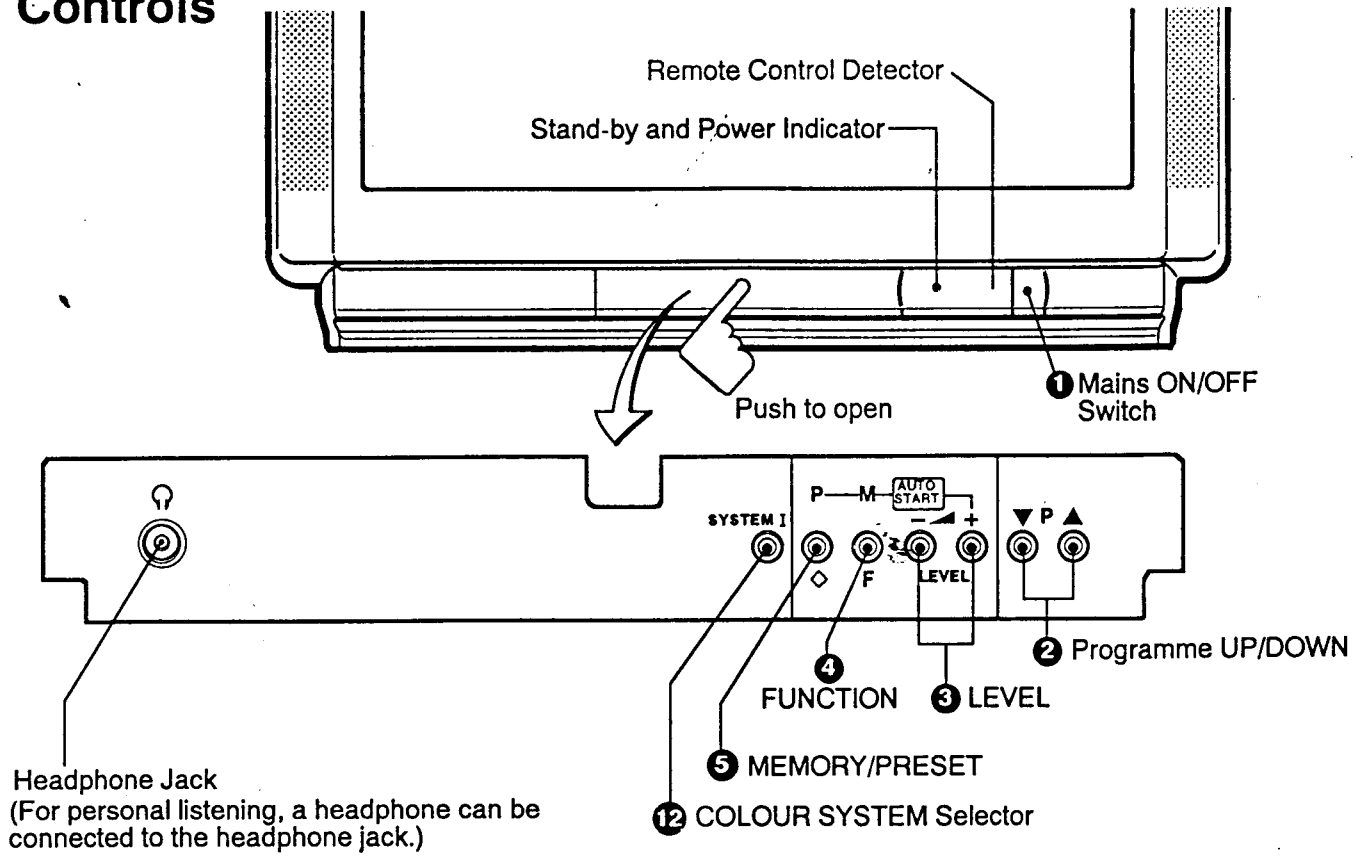

Remote Control Transmitter

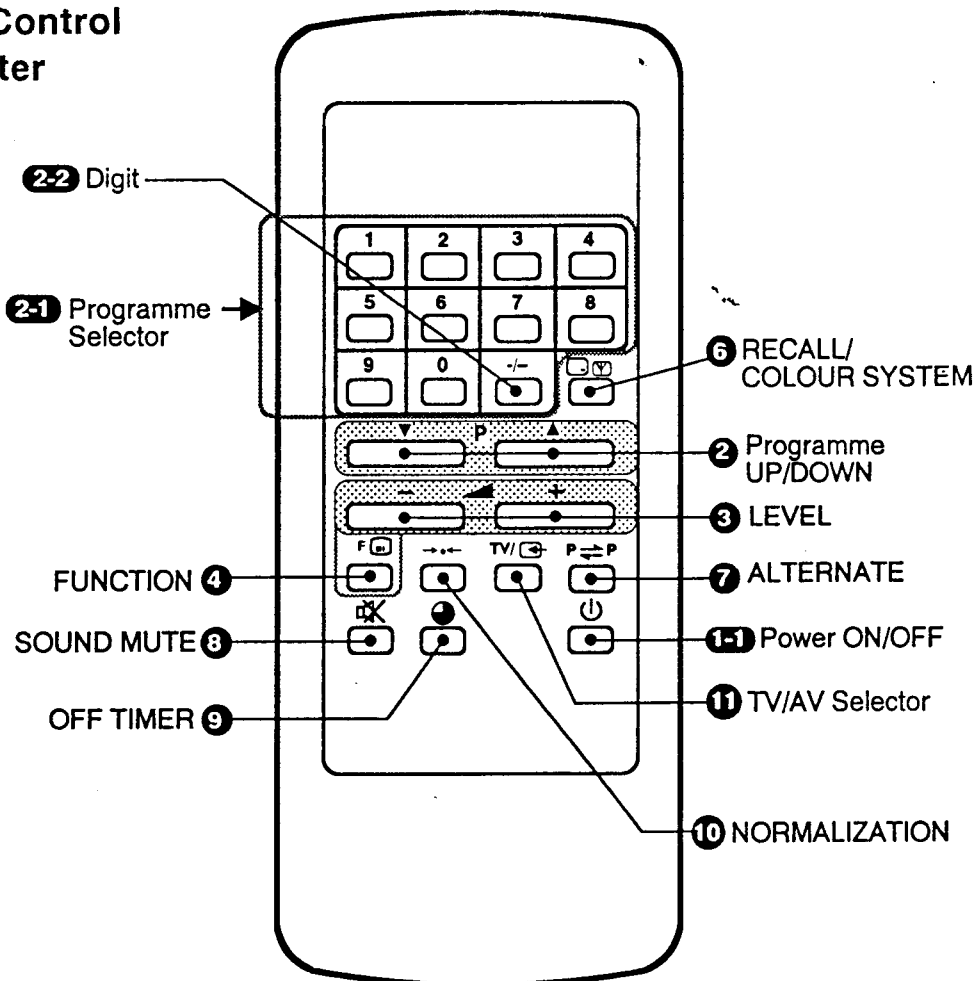

General Operation

POWER ON/OFF

To switch the TV on or off;

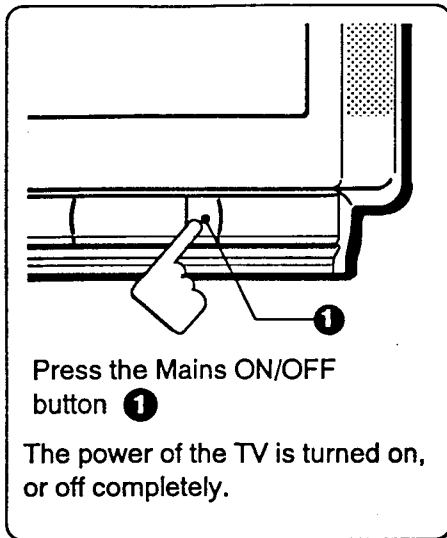

To set the TV into standby mode;

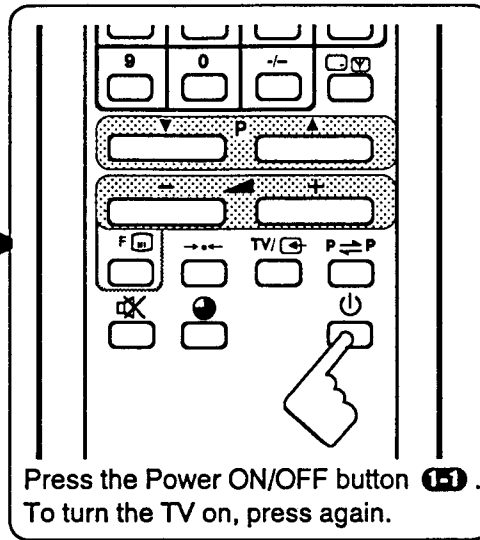

To turn on the TV from standby mode;

Press

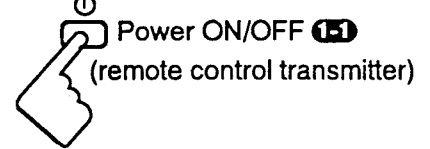

or

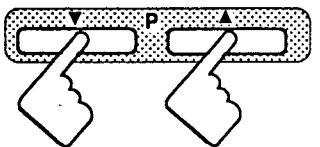

Programme UP/DOWN **2**
(remote control transmitter)

or 1 to 9, 0 Key

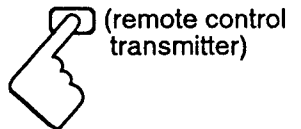

or

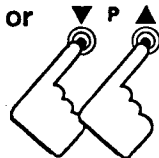

Programme UP/DOWN **2**
(TV set)

Important !

Be sure to set the Mains ON/OFF switch **1** to the off position, if the power failure occurs while viewing.

AUTO SHUT OFF

This TV set incorporates the AUTO SHUT OFF function. Even if the TV is left on after you have gone to sleep, the TV set changes to the standby mode within 10 minutes after all broadcasts have ended.

Remaining time

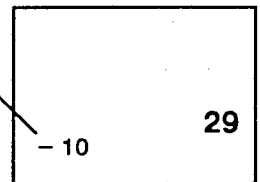

PROGRAMME SELECTION (Direct Selection)

To select a programme directly

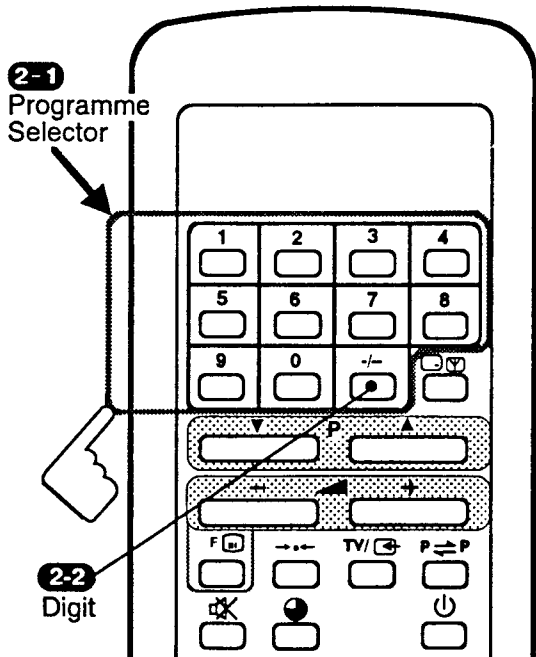

For example

To select programme 8

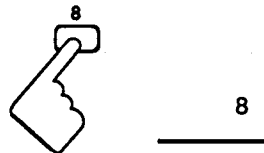

To select programme 10

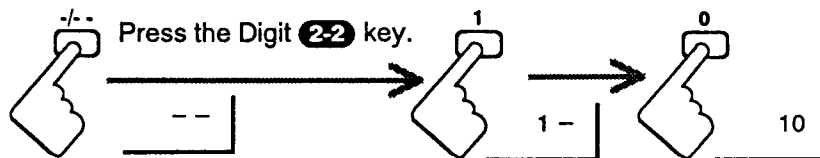

To select programme 27

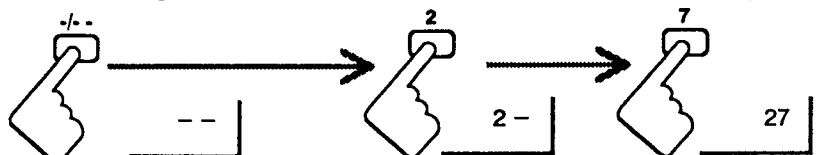

General Operation

Programme Selection (Programme UP and Down)

To select a channel

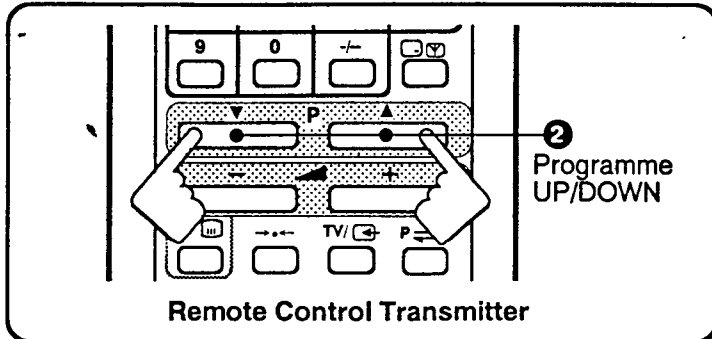

or

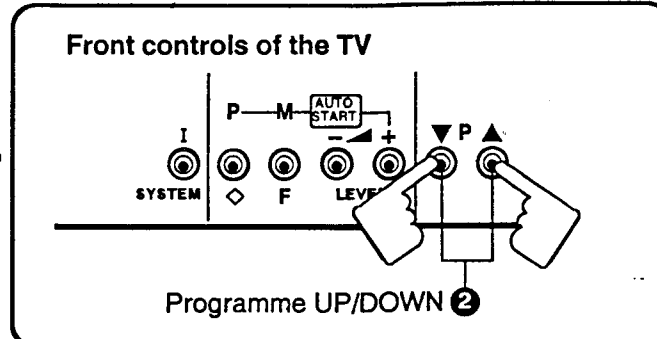

Volume Control

To adjust the sound volume

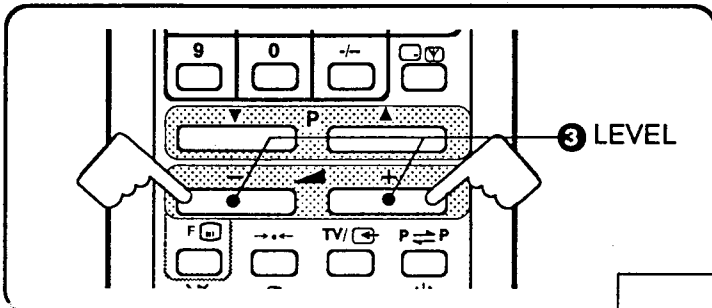

or

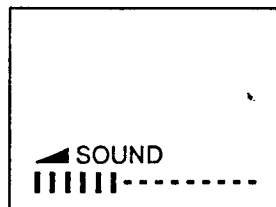
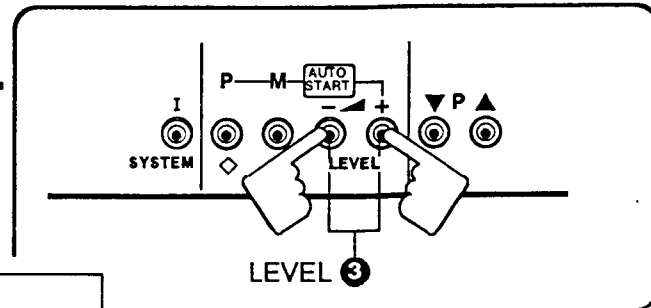

RECALL

To display the on screen indications, press the RECALL / COLOUR SYSTEM button.

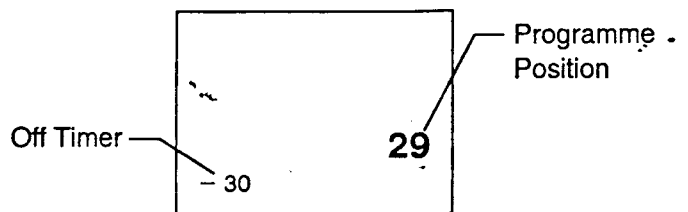
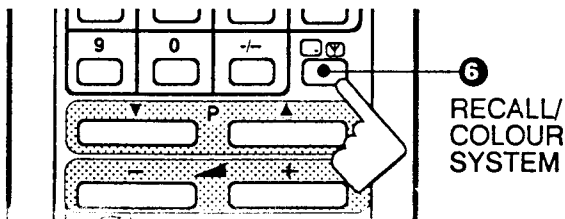

Screen display disappears after about 5 seconds.

ALTERNATE

Press the ALTERNATE 7 key, and the programme position will alternately select the previous position and the present position.

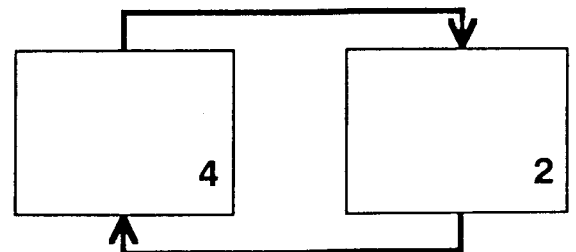
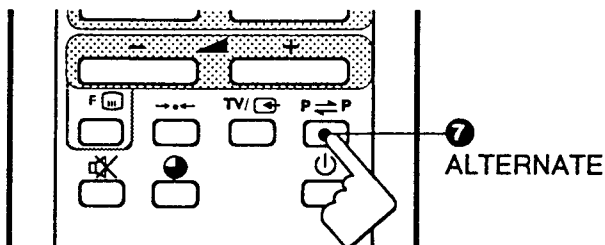

For example, now you are watching programme position "4" but you watched programme position "2" previously. If you press the ALTERNATE key, programme position "2" immediately appears.

General Operation

SOUND MUTE

Should you wish to mute the sound (e.g. While talking on the telephone), press the SOUND MUTE **8** key.

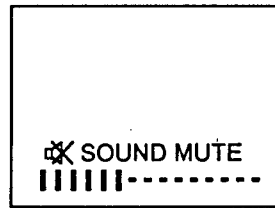
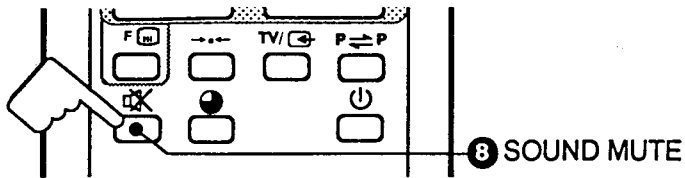

To switch the sound back on, press the SOUND MUTE key again.

OFF TIMER

The TV set will be turned off after about 30, 60, 90 or 120 minutes.

Press the OFF TIMER **9** key.

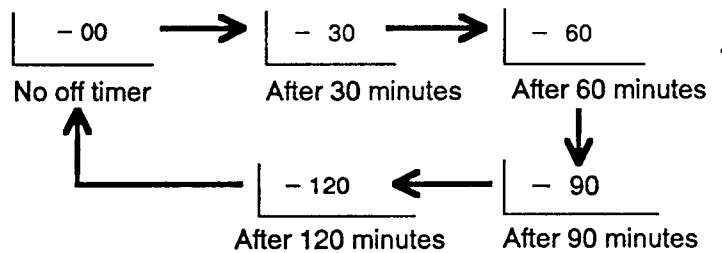
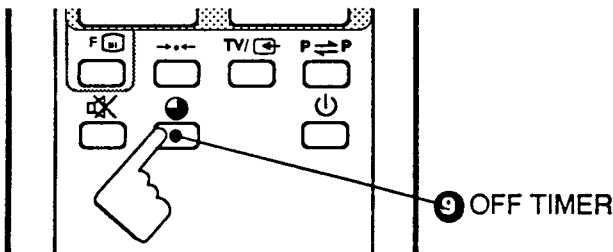

Just one minute before switching off the TV, " - 01 " and channel number will be displayed on the screen.



To cancel the OFF TIMER

Press the OFF TIMER key until " - 00 " appears.

MEMORY

This function lets you store the settings (for colour, brightness, contrast, tint, sharpness, sound volume) in the memory for both picture and sound, and these setting levels can be recalled by pressing the NORMALIZATION **10** key of the remote control transmitter.

To store the picture and sound settings

(1) Set the picture and sound to the desired levels. etc.

(2) Press the MEMORY/PRESET **5** button while the control function display is still visible on the screen.



NOTE: The control settings will not be saved if the MEMORY button is pressed after the control function display has left the screen.

NORMALIZATION

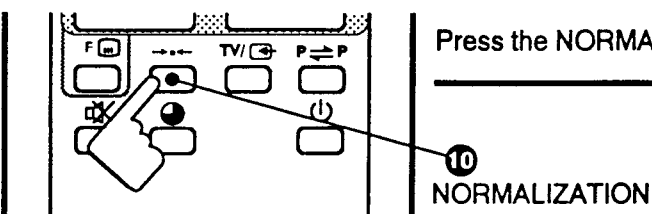

Press the NORMALIZATION **10** key.

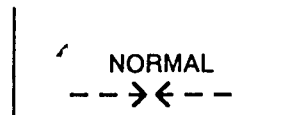

The colour, brightness, contrast, tint, sharpness and sound volume settings which you stored using the MEMORY button are recalled.

General Operation

PICTURE ADJUSTMENTS

(1) Select the adjustment item using the FUNCTION **4** key.

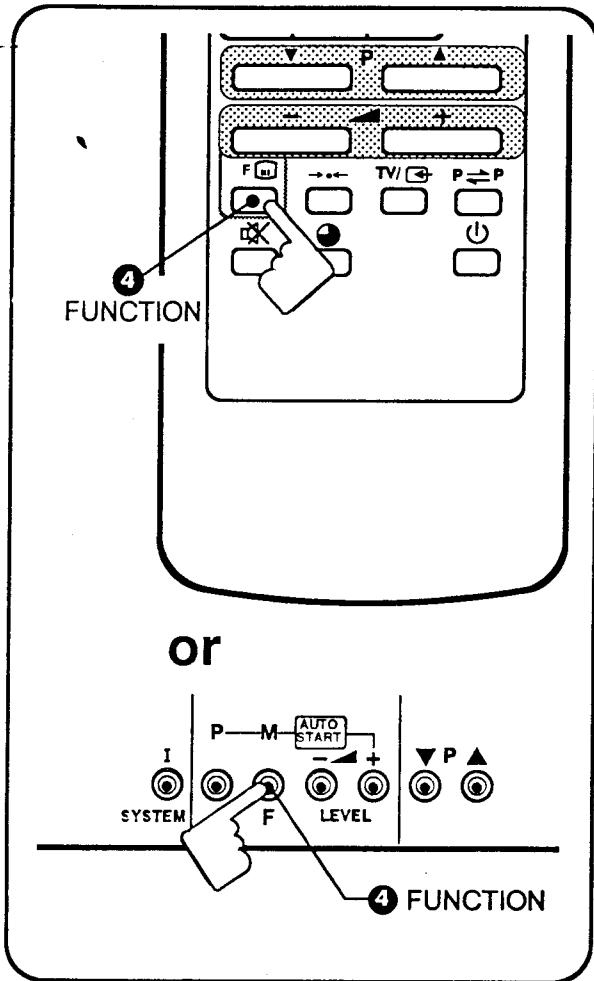

(2) Adjust using the LEVEL **3** + and - key.

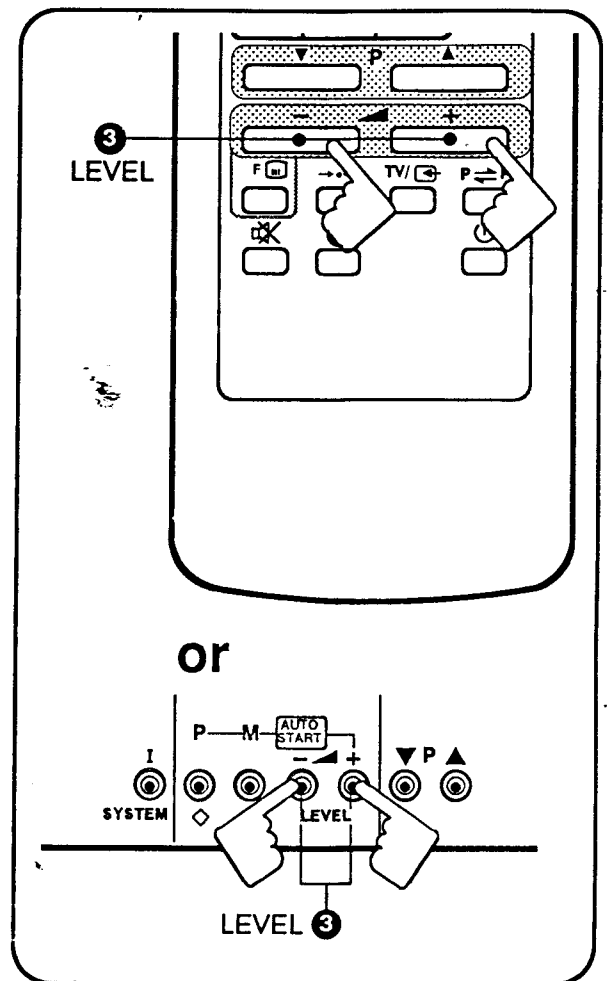

Each time the FUNCTION key is pressed, function choice will change as follows:

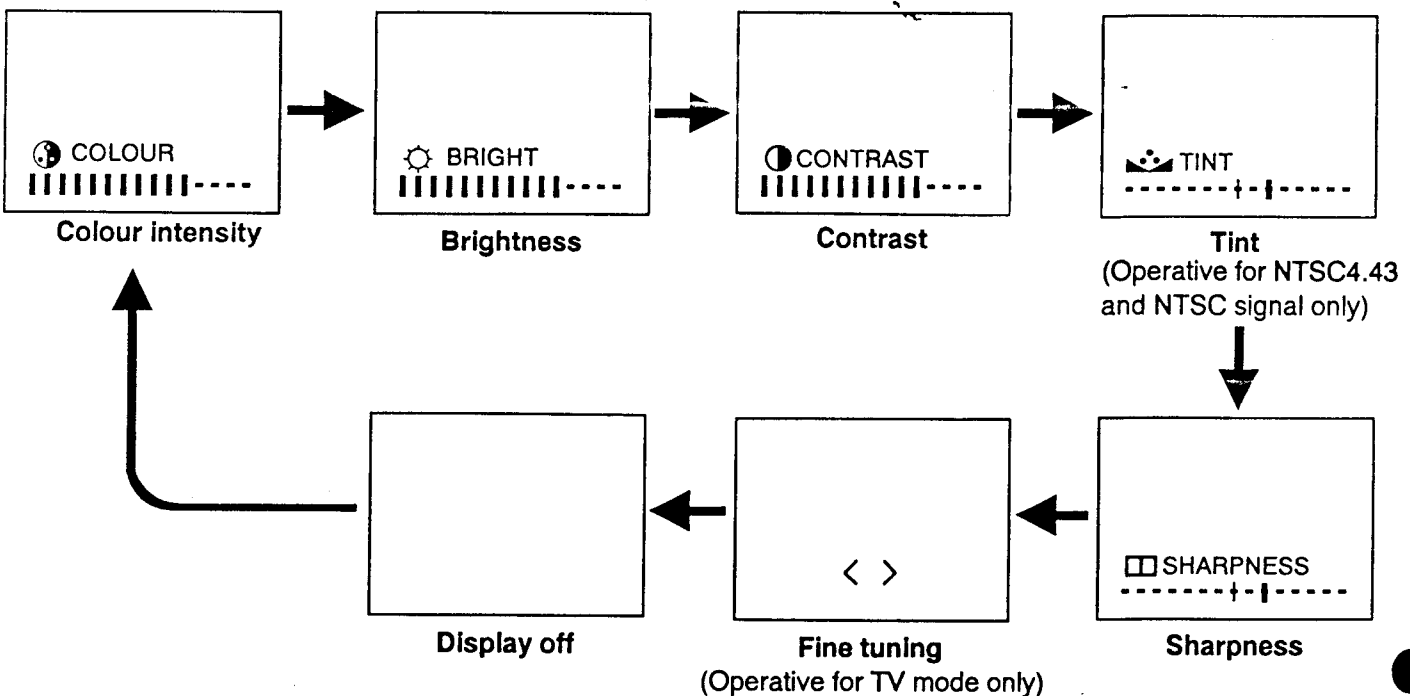

Tuning of the Channels

Up to 30 broadcast stations in your reception area can be stored in the electronic memory.

There are three ways of tuning as follows;

Automatic Tuning (the basic way)

All receivable channels are automatically tuned in and memorized in consecutive programme positions.

Semi-Auto Tuning

Use to preset a receivable channel in any desired programme position, e.g. the position with the same number as the channel.

Manual Tuning

Manually tune a channel if it cannot be automatically tuned, such as when the signal is poor.

Automatic Tuning

(1) Press the MEMORY/PRESET button ⑤.

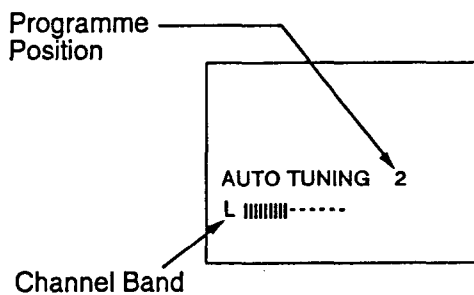
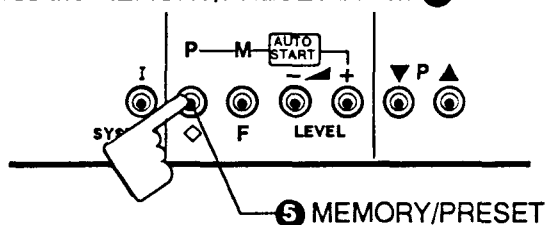

(2) Press the LEVEL (+) ③ button.

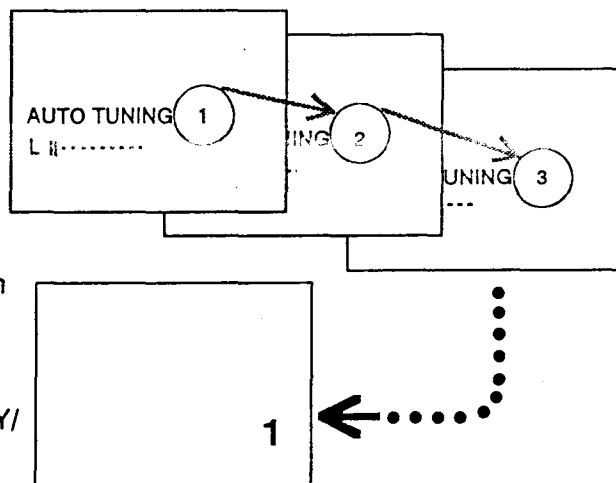
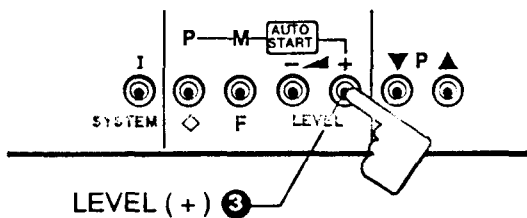

The channels are preset in consecutive positions beginning from the programme position "1".

After all available channels have been preset, the unit returns to the position "1".

Note: To cancel automatic tuning midway, press the MEMORY/PRESET ⑤ or Power ON/OFF ①-② button.

Channel Copy

Example: To copy the TV channel in the programme position 2 into the programme position 6

(1) Select programme position 2 using Programme selector ②-①.



(2) Press the MEMORY/PRESET button ⑤ 3 times.

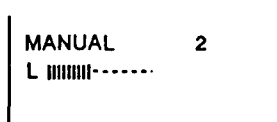

(3) Select programme position 6 using Programme UP/DOWN ② button of the TV set.

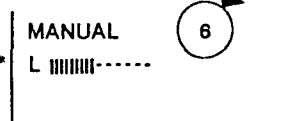

(4) Press FUNCTION button ④.

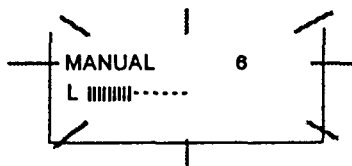

(5) Press the MEMORY/PRESET button ⑤.



Tuning of the Channels

Semi-Auto Tuning & Manual Tuning

Example: To preset a channel in programme position 6

Semi-Auto Tuning

Manual Tuning

(1) Select programme position 6 using Programme selector **2-1**.

6

(2) Press the MEMORY/PRESET button **5** twice.

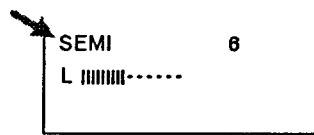

(2) Press the MEMORY/PRESET button **5** 3 times.

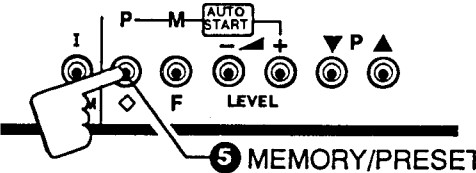
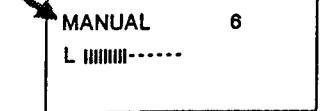

(3) Press the LEVEL(+) or (-) **3** button.

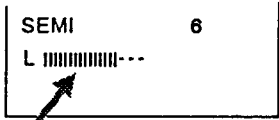

When a station is found, searching stops automatically.

(5) Press and hold the LEVEL(+) or (-) **3** button until the desired station appears.

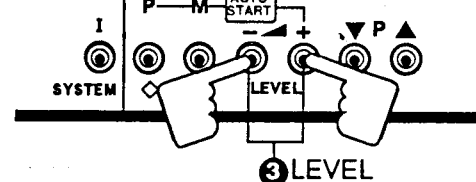
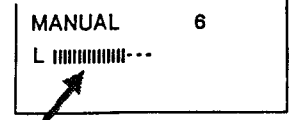

(4) Press FUNCTION button **4**.

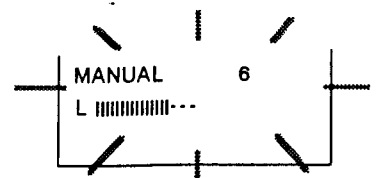
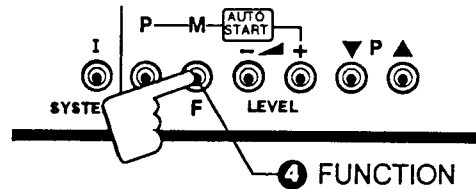
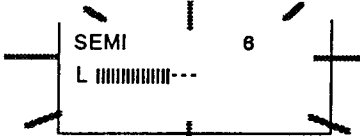

(5) Press the MEMORY/PRESET button **5** twice.

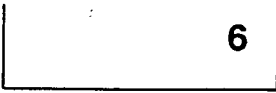

This completes the presetting.

(7) Press the MEMORY/PRESET button **5**.

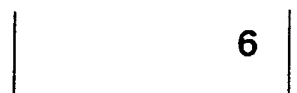

This completes the presetting.

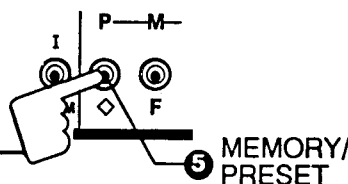

Repeat steps 1 to 5 for other desired channels.

Setting Restricted Programmes

To restrict programme positions that you do not want others to watch. Any positions can be restricted.

How to Set Restrictions

For example, to restrict programme position "15".

- 1 Select programme position "15".

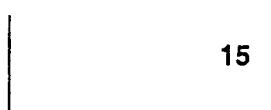

- 2 Press and hold the RECALL/COLOUR SYSTEM **6** button for more than 2 seconds.

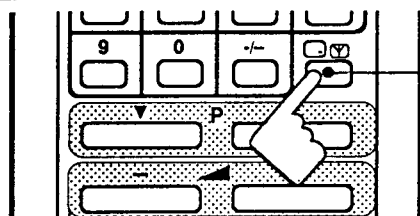

6
RECALL/
COLOUR
SYSTEM

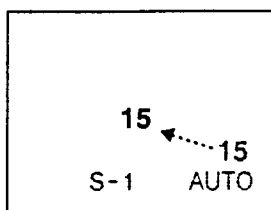

The programme number "15" will move to the center of the screen.

- 3 Press the FUNCTION **4** button.

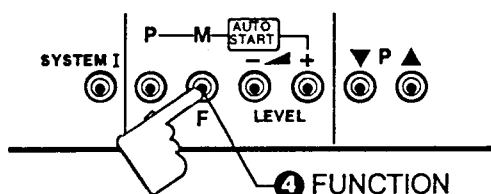

4 FUNCTION



The picture will disappear, and "X 15" will be displayed on the screen.

The restricted setting is now completed.

Watching a TV programme that has been restricted

To watch a TV programme that has been restricted.

- 1 Select the restricted position (position "15").

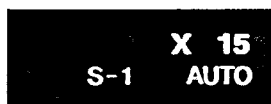

- 2 Press and hold the RECALL/COLOUR SYSTEM **6** button for more than 2 seconds.

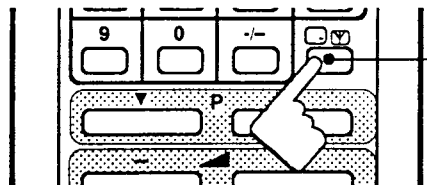

6

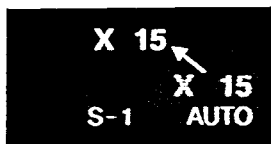

The programme number and "X" will move to the center of the screen, and the picture will appear.

- 3 Press the RECALL/COLOUR SYSTEM **6** button for watching a TV programme.

Note: The position "15" is still in the restricted position.

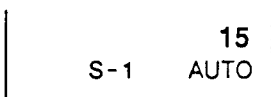

Cancelling of the Restriction

To cancel the restriction

- 1 Select the restricted position.

- 2 Press and hold the RECALL/COLOUR SYSTEM **6** button for more than 2 seconds. The programme number and "X" will move to center of the screen, and the picture will appear.

- 3 Press the FUNCTION **4** button for cancelling the restricted position. The "X 15" will disappear.

12 The cancelling of the restriction is complete.

Maximum volume level setting and suppression of channel tuning

It is possible to set the maximum sound volume at your preference and suppresses the channel tuning function so that even if the MEMORY/PRESET button is pressed, the channel tuning mode (preset mode) will remain inactive.

Setting procedure

- 1 Set the desirable volume level using the LEVEL **3** button.

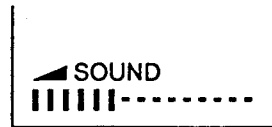
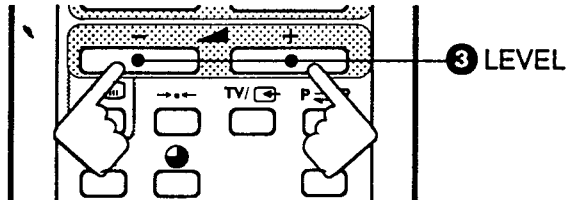

The volume level set in this procedure will be memorized as the maximum volume level.

- 2 Press and hold the FUNCTION **4** button on the front control panel of the TV set, then press the RECALL/COLOUR SYSTEM **6** button on the remote control transmitter.

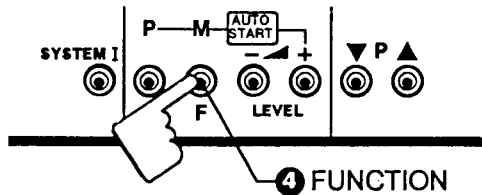

etc.

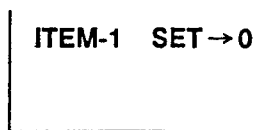
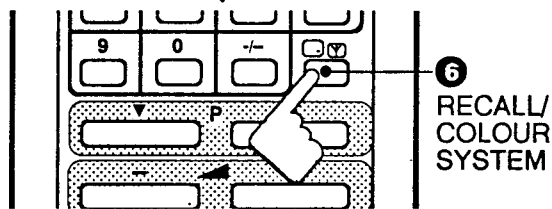

- 3 Select "1", by pressing LEVEL (+ or -) **3** button.

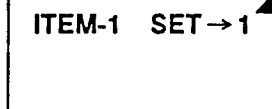

- 4 Press the RECALL/COLOUR SYSTEM **6** button to return to the normal TV mode.

Cancelling procedure

- 1 Press and hold the FUNCTION **4** button on the front control panel of the TV set, then press the RECALL/COLOUR SYSTEM **6** button on the remote control transmitter.

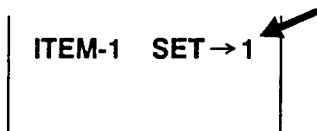

- 2 Select "0", by pressing LEVEL (+ or -) **3** button.

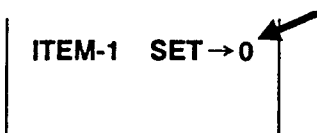

- 3 Press the RECALL/COLOUR SYSTEM **6** button to return to the normal TV mode.

Connecting other Equipment

Connecting to the AV Input Jacks

Connect the video and audio outputs of a VCR, video disc player, etc. to the input jacks of this TV set. Tapes and discs can be played back.

AV Terminal (Rear of the Set)

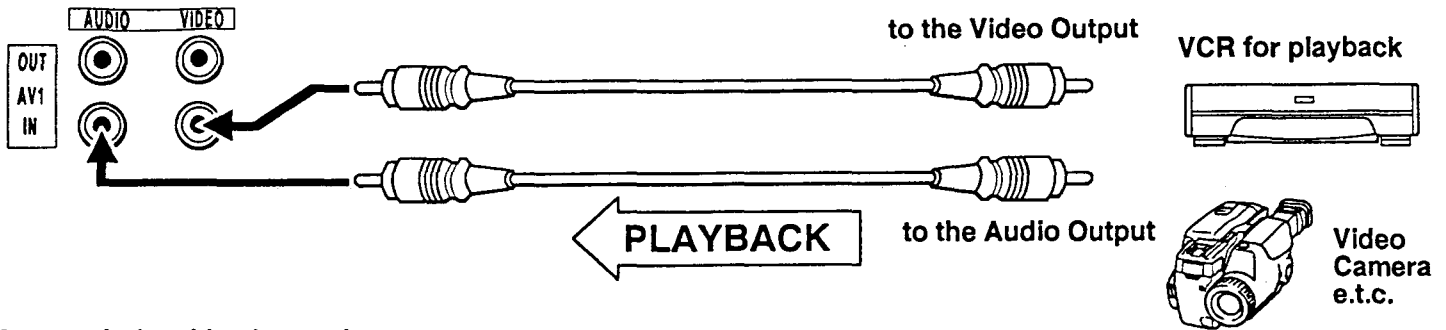

To watch the video input picture

(1) Press the TV/AV Selector **11**.

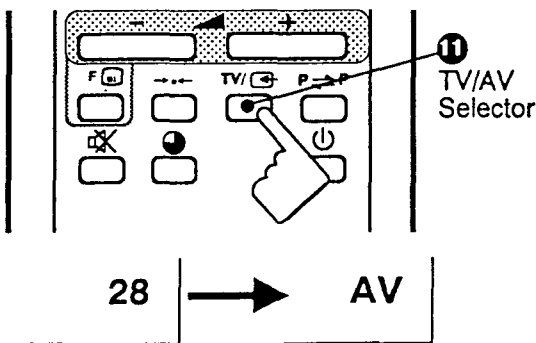

(2) Set the VCR to playback mode.

If necessary, select the colour system to match the appropriate AV equipment. Each time the COLOUR SYSTEM **6** or **12** button is pressed, colour system changes as follows;

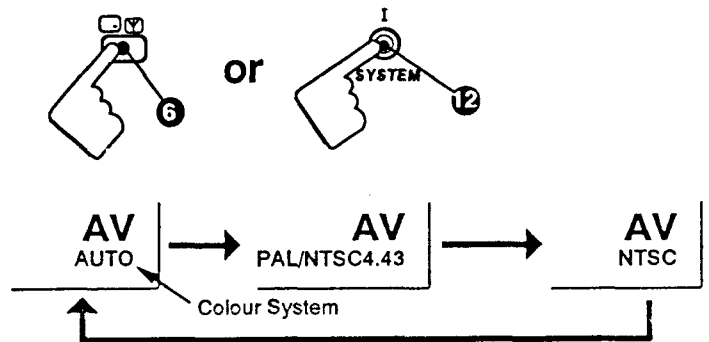

Colour system setting for AV mode is automatically stored in the memory.

To return to the TV mode;

Press the TV/AV Selector again.

Note: Pressing either of the Programme UP/DOWN buttons on the remote control or the TV will return the TV to TV mode.

You can select a TV programme while watching a playback from a VCR

For example:

- To select the programme position "9" while watching a playback from external VCR, press "9" button of the remote control. The TV set return to the TV mode and programme "9" will be selected.
- To select the programme position "26", press "--/--" button, "2" then "6" button. The TV set return to the TV mode and programme "26" will be selected.

Connecting to the AV Output Jacks

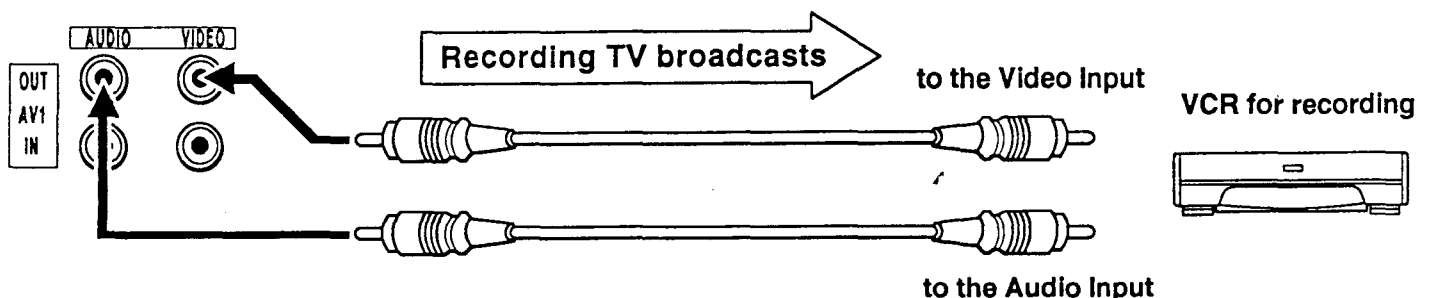

Connecting other Equipment

To record a TV broadcast while watching the playback from a VCR

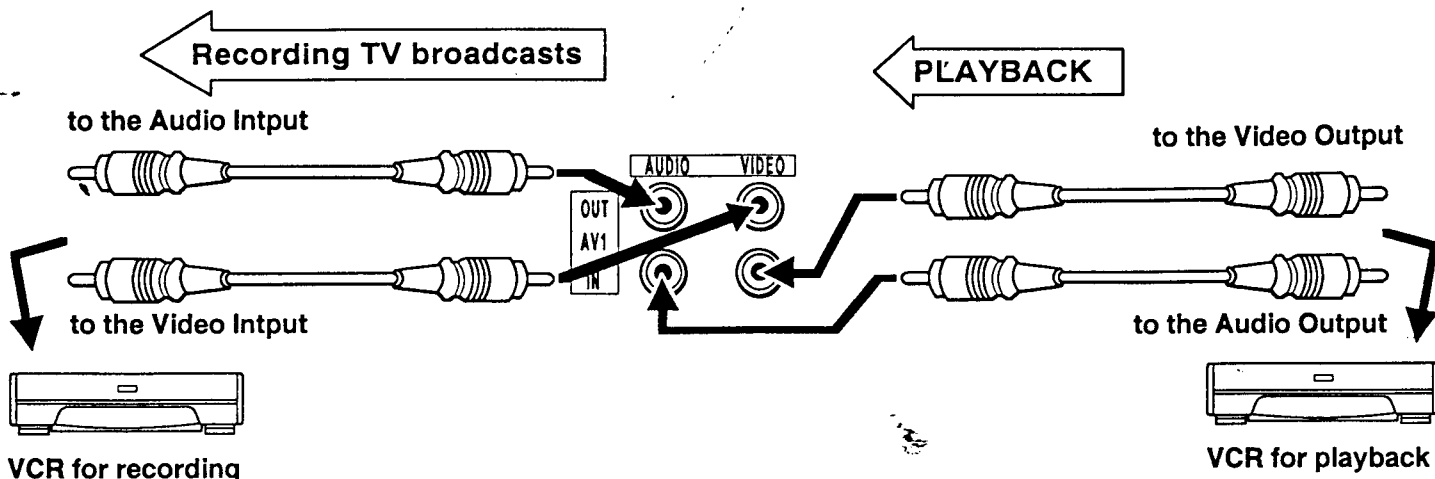

Example: To record a TV broadcast of the programme position "7" while watching the playback from a VCR,

- (1) Select the programme position "7".



- (2) Set the TV receiver to the AV mode to watch the playback from a VCR.



- (3) Set the VCR for recording to the recording mode.

AV Connection to the Aerial Socket

The AV apparatus can also be connected to the aerial socket of your TV receiver.

Presetting to watch the video input

- (1) Play back the VCR.
- (2) Tune a channel in programme position 0 (See Semi-auto tuning & Manual tuning on page 11).

Watching the video input

Select programme position 0.

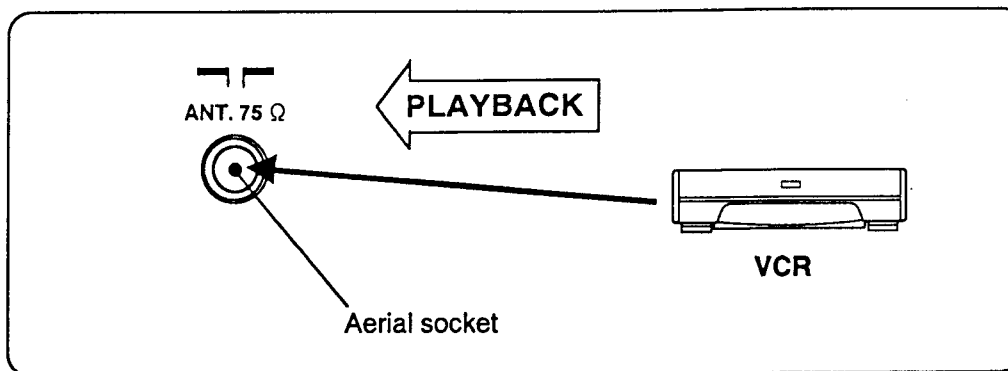
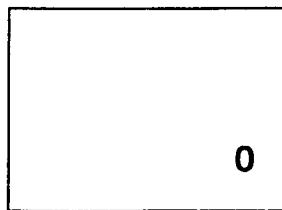

For further details concerning this connection and adjustment, refer to the operating instructions for the AV equipment.

Aerial Connection

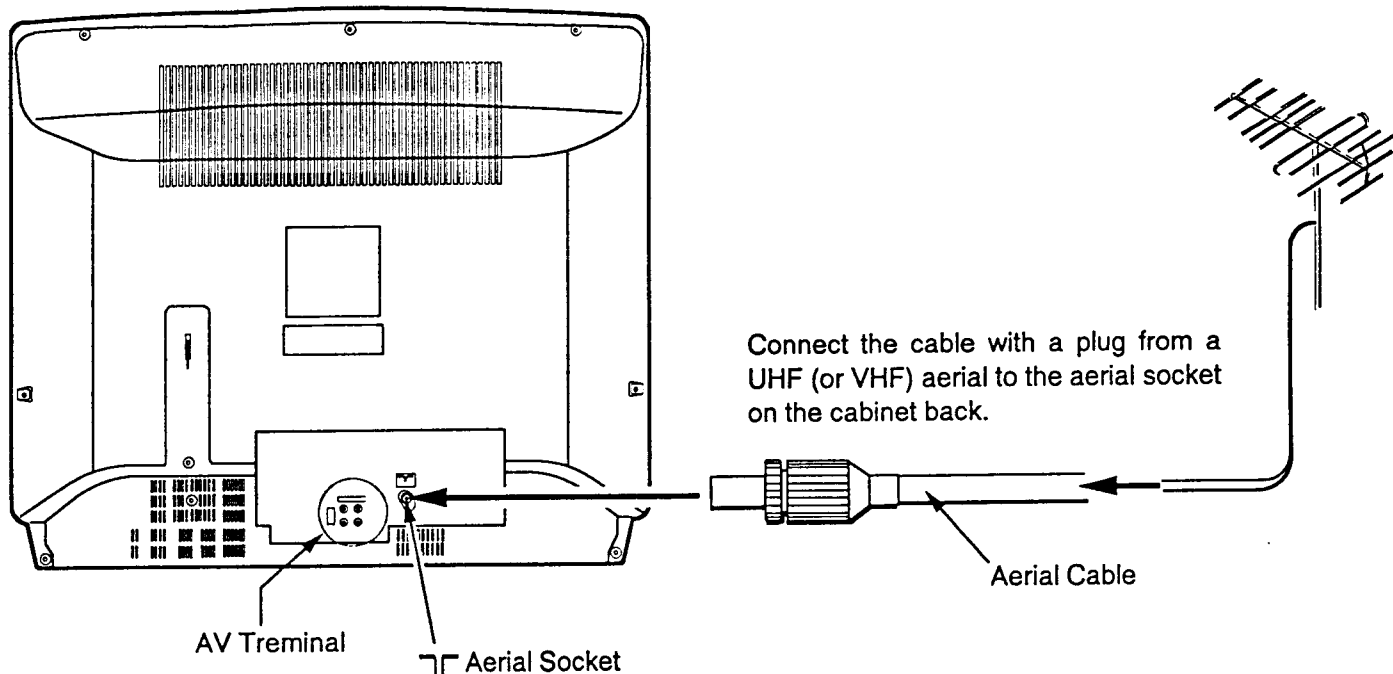

For all aerial circuit problems please consult your local dealer.

Specifications

Power Source AC 220-240 Volts, 50Hz.

Receiving System PAL-B/G
(AV Input: PAL/NTSC/NTSC4.43)

Channel Coverage VHF: 1-11
UHF: 21-69

Aerial Input Impedance 75 Ω

Speakers 6cm \times 12cm \times 2 speakers

Audio Output (Music) 5.0 W

Ext. Terminals AV Inputs:
Video input(Phono jack) x 1 (1.0Vp-p, Impedance 75 Ω)
Audio input(Phono jack) x 1 (436mVrms, Impedance more than 40K Ω)
AV Outputs:
Video output(Phono jack) x 1 (1.0Vp-p, Impedance 75 Ω)
Audio output(Phono jack) x 1 (436mVrms, Impedance less than 600 Ω)
Headphone jack(Mini jack) x 1

Dimensions 700(W) \times 601.5(H) \times 495(D)mm

Weight approx. 39.1Kg

Specifications subject to change without notice.

SANYO

SANYO ELECTRIC Co., Ltd

Part No. 1AA6P1P0927-- E8DK (AA1-A)