

SANYO

INSTRUCTION MANUAL

CDP-4100CR

Compact Disc Player

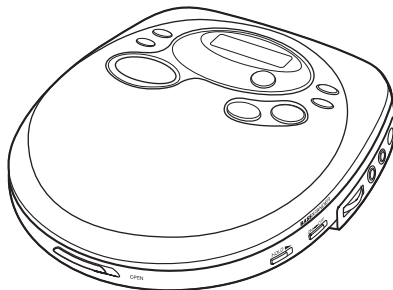

PRECAUTIONS

CAUTION

USE OF CONTROLS OR ADJUSTMENT OR PERFORMANCE OF PROCEDURES OTHER THAN THOSE SPECIFIED HEREIN MAY RESULT IN HAZARDOUS RADIATION EXPOSURE.

THIS COMPACT DISC PLAYER SHOULD NOT BE ADJUSTED OR REPAIRED BY ANYONE EXCEPT QUALIFIED SERVICE PERSONNEL.

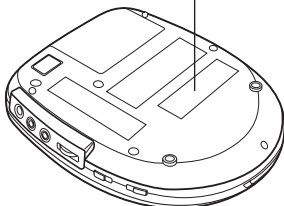
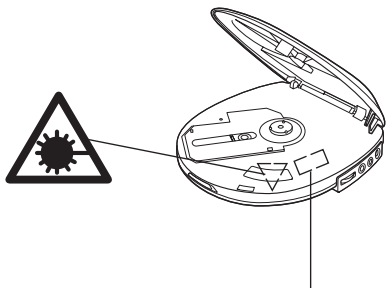

CAUTION – INVISIBLE LASER RADIATION WHEN OPEN AND INTERLOCKS DEFEATED. AVOID EXPOSURE TO BEAM.

ADVARSEL – USYNLIG LASER STRÅLING VED ÅBNING, NÅR SIKKERHEDSAFBRYDERE ER UDE AF FUNKTION, UNDGÅ UDSÆTTELSE FOR STRÅLING.

VARNING – OSYNLIG LASER STRÅLNING NÅR DENNA DEL ÄR ÖPPNAD OCH SPÄRR ÄR URKOPPLAD. STRÅLEN ÄR FARLIG.

VORSICHT – UNSICHTBARE LASERSTRAHLUNG TRITT AUS, WENN DECKEL GEÖFFNET UND WENN SICHERHEITSVERRIEGELUNG ÜBERBRÜCKT IST. NICHT, DEM STRAHL AUSSETZEN.

VARO – AVATTAESSA JA SUOJALUKITUS OHITETTAESSA OLET ALTTIINA NÄKYMÄTTÖMÄLLE LASERSÄTEILYLLE. ÄLÄ KATSO SÄTEESEEN.

- High volume levels can create potentially dangerous situations by drowning out surrounding sounds. Use caution when driving while operating the unit, and obey all applicable laws. Do not play your headset at a high volume level. Hearing experts advise against continuous extended play. If you experience a ringing in your ears, reduce the volume or discontinue use.
- Do not use while bicycling, running or operating a motorized vehicle.
- The rating label is located on the bottom of the unit.
- The apparatus shall not be exposed to dripping or splashing.
- Do not use where there are extremes of temperature (below 5°C or exceeding 35°C).
- Sudden changes in the ambient temperature may cause condensation to form on the optical lens inside the unit. If this happens, take out the disc, leave the unit for about 1 hour, and then proceed to operate.
- Do not insert pins, etc., inside the unit.

This unit is equipped with a safety device which automatically turns the laser beam off when the disc compartment is opened. If a pin or other metal object should get inside the unit, however, this safety device may be deactivated.

CONTROLS

1. Disc compartment
2. Play/Pause button (PLAY/PAUSE)
3. Stop button (STOP)
4. Play mode button (P-MODE)
5. Programme button (PROG)
6. Display
7. Anti rolling shock button (ANTI SHOCK/ROLL)
8. Skip/Search buttons (SKIP/SEARCH)
9. Battery compartment (bottom)
10. External DC socket (DC 6V)
11. Line output socket (LINE OUT)
12. Headphones socket (PHONES)
13. Volume control (VOLUME)
14. Bass expander switch (BASSXPANDER)
15. Hold switch (HOLD)
16. Open switch (OPEN)

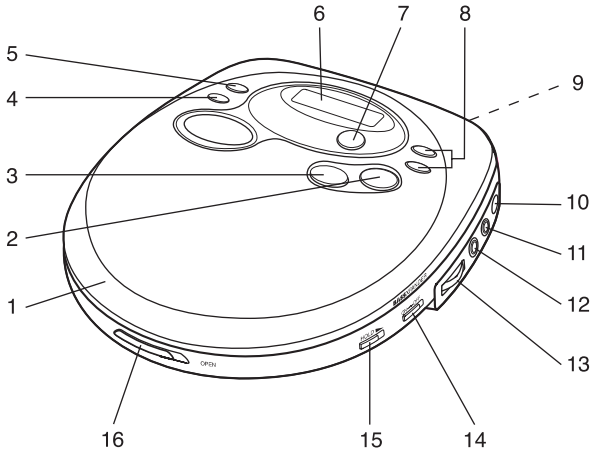

The buttons on the remote control function in the same way as the corresponding buttons on the unit.

1. Skip/Search buttons (SKIP)
2. Volume Control (VOLUME)
3. Play/Pause button (PLAY/PAUSE)
4. Stop button (STOP)

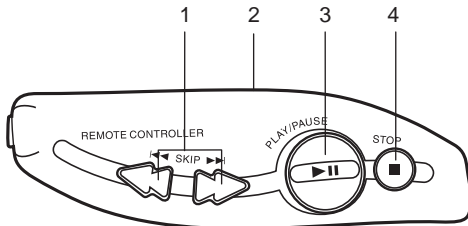

POWER SUPPLY

AC adaptor

Plug one end of the AC adaptor into the DC 6V socket, then plug the other end into an AC outlet.

- Use only the supplied AC adaptor
- If the AC adaptor is connected. The power supply automatically switches to the AC power source and the installed batteries are disconnected.

Rechargeable battery

1. Install the rechargeable nickel-cadmium battery (SANYO NBP-50A) as shown below. Observe proper polarity.

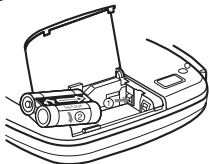
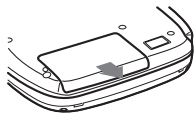

2. Connect the AC adaptor. The battery is fully charged approximately 10 hours after the AC adaptor is connected.

- Do not charge continuously for 24 hours or more.

CONTAIN NICKEL-CADMIMUM BATTERY. MUST BE RECYCLED OR DISPOSED OF PROPERLY.

Alkaline batteries

Install two “AA” batteries (not supplied) as shown below. Observe proper polarity.

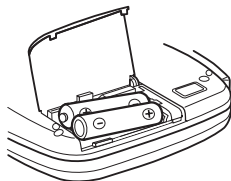

Battery recharging or replacement

If the rechargeable battery or alkaline batteries are weak and discharged, “” blinks on the display, then the power automatically turns off. If this occurs, recharge the rechargeable battery or replace the alkaline batteries.

- Dispose of all used batteries safely and in accordance with all applicable laws.

Note:

When you are not going to use the unit for one month or more, take the batteries out of the battery compartment.

CIGARETTE LIGHTER ADAPTOR

The supplied cigarette lighter adaptor is designed for use with vehicles that have a 12V, negative ground electrical system. Most vehicles have this type of electrical system, but if you are unsure about the type your vehicle has, contact the vehicle dealer.

Plug one end of the cigarette lighter adaptor into the DC 6V socket, then plug the other end into the cigarette lighter socket.

Caution:

- Use this unit only with the supplied cigarette lighter adaptor.
- Be sure to clean the cigarette lighter socket before use.
- After use, disconnect the cigarette lighter adaptor.

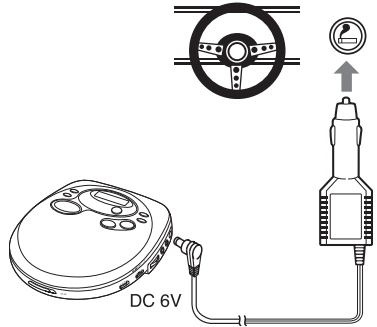

BEFORE OPERATION

Anti rolling shock function

In the previous anti-shock function, when skips occurred while available memory runs out, then the sound would suffer some interruption.

The new anti rolling shock function is designed to prevent skipping to the greatest extent possible instead of supplementing the skipped portion of the sound. This is achieved by expanding the memory capacity, and in addition full attention has been given also to increasing the unit's signal reading capability. Moreover, consideration has been given to eliminating the basic causes of skipping, both from the standpoint of horizontal shock and vertical shock. Use this function when listening during walk or playing in a car.

When the PLAY/PAUSE button is pressed first time, the anti rolling shock function turns on automatically. "ANTI" appears on the display. The "ANTI" changes to "ANTI" when the buffer memory is full of next 45 seconds music data.



Note:

- Press the ANTI SHOCK/ROLL button to turn the anti rolling shock function off. "ANTI" disappears. Press the button again to turn it on.
- Sound may skip or mute for a few seconds when you press the ANTI SHOCK/ROLL button during play.
- Playing may stop when the unit gets strong shock even when the anti rolling shock function is on.

Bass expander system

Set the BASSXPANDER switch to ON to enhance the bass sound.

Auto power on function

The power turns on automatically when PLAY/PAUSE button is pressed.

Auto power off function

The power turns off automatically after about 1 minute when all tracks on a disc have been played or when the STOP button is pressed once to stop play.

Hold function

The HOLD switch disables the buttons from operating to prevent play from starting or stopping due to accidental operation. For normal use, leave the switch in the off position.

To prevent battery drain:

Set the HOLD switch to the on position when carrying the unit in a bag. The PLAY/PAUSE button will not function even if the button is pressed accidentally.

“00 00 00^{HOLD}” appears briefly on the display.

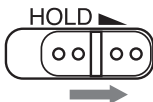

To prevent play from being interrupted:

Set the HOLD switch to the on position after starting play. “HOLD” appears.

If the operating buttons do not function when pressed ...

1. Check whether the HOLD switch is on or not.
2. Remove the batteries and/or disconnect the AC adaptor from the unit. Wait a few seconds, then reinstall the batteries or reconnect the AC adaptor.
3. If the buttons still do not function, insert new batteries or charge the rechargeable battery.

HANDLING COMPACT DISCS

Use compact discs bearing the symbol shown below. In addition to conventional 12 cm CDs, this unit can be used to play 8 cm CDs without an adaptor.



- Do not expose the disc to direct sunlight, high humidity or high temperatures for extended periods of time.
- Discs should be returned to their cases after use.
- Do not apply paper or write anything on the disc surface.
- Handle the disc by its edge. Do not touch the playing surface (glossy side).
- Fingerprints and dust should be carefully wiped off the playing surface of the disc with a soft cloth. Wipe in a straight motion from the center to the outside of the disc.
- Never use chemicals such as record cleaning sprays, antistatic sprays or fluids, benzene or thinner to clean compact discs.

The unit will not play a disc that has been inserted upside down, or discs which do not conform to the Compact Disc standard.

PLAYING A DISC

- Be sure to reduce the volume before connecting or disconnecting the headphones.

BASIC CD PLAY

1. Connect the remote control and headphones, then plug the cord from the remote control into the PHONES socket.

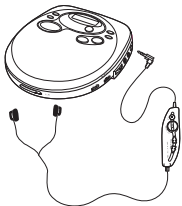

2. Slide the OPEN switch right to open the disc compartment lid.

3. Hold the disc with the labeled side up and press it onto the pivot until it “clicks” into place.

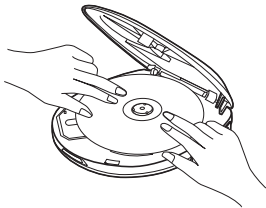

WARNING!

Do not insert your fingers into the opened panel. You may damage the unit or cause personal injury.
Do not allow young children to operate the unit unattended.

To remove the disc
Remove the disc while pressing the pivot.

4. Close the disc compartment lid.

5. Press the PLAY/PAUSE button to begin play.



Track number

Elapsed playing time

- The track number and elapsed playing time for the current track are displayed.
6. Adjust the VOLUME control as desired.
 7. To stop play temporarily, press the PLAY/PAUSE button. The display blinks. Press the PLAY/PAUSE button again to resume.
 8. To stop play, press the STOP button once. The total number of tracks and total playing time appear.
- To turn the power off, press the STOP button once again.

Skip play

To skip to track 6 while track 3 is playing, press the ►► SKIP/SEARCH button repeatedly until "06" appears on the display. To skip back to track 3 while track 6 is playing, press the ◄◄ SKIP/SEARCH button repeatedly until "03" appears.

Search (forward/reverse)

If the ►► or ◄◄ SKIP/SEARCH button is pressed during play, the player will search at high speed in the forward or reverse direction while the button is being pressed. When the button is released, normal play will continue.

PROGRAMMED PLAY

Up to 24 tracks on a disc can be programmed for play in any order.

1. Press the PROG button during stop.



2. Press the ►► or ◀◀ SKIP/SEARCH button to select a track.

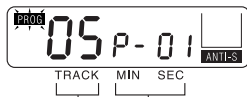

Track number

Programme number

3. Press the PROG button.



4. Repeat steps 2 and 3 to programme tracks.
5. To check the programme contents after all tracks have been programmed, press the PROG button repeatedly. The programmed track numbers sequentially appear on the display.
 - The check will not operate if 24 tracks have been programmed.
6. Press the PLAY/PAUSE button to start programmed play.



- To cancel programmed play, press the STOP button twice.

VARIOUS PLAYING MODE

Press the P-MODE button repeatedly during stop to select a various play mode available. Each time the button is pressed, the mode changes as shown below:

Repeat one (⏮ 1) → Repeat all (⏮ ALL) → Introscan (INTRO) → Random play (RAND) → Released

- During programmed play mode, "RAND" (random play) can not be selected.

Once the desired play mode is displayed, press the PLAY/PAUSE button to begin play in that mode.

REPEAT PLAY

You can play tracks repeatedly in normal or programmed play modes.

Single track repeat

Press the P-MODE button once during play "⏮ 1" appears on the display.

All tracks repeat

Press the P-MODE button twice during play. "⏮ ALL" appears.

- To cancel repeat play, press the P-MODE button repeatedly until "⏮ 1" or "⏮ ALL" is disappeared.

INTROSCAN

1. Press the P-MODE button three times during stop. "INTRO" appears.
2. Press the PLAY/PAUSE button. The first 10 seconds of each track on a disc are played from the first track.
3. When the desired track is playing, press the P-MODE button twice. Normal play continues.

RANDOM PLAY

1. Press the P-MODE button four times during stop. "RAND" appears.
 2. Press the PLAY/PAUSE button. All tracks on the disc are played in random order.
- To cancel random play, press the P-MODE button once.

CAR CASSETTE ADAPTOR

Before use

Check the cassette tape insert slot of your car stereo. If necessary, change the direction of the cord on the cassette shaped pack of the adaptor.

- There may be some car stereo types with which this car cassette adaptor will not work properly.

To change the cord direction

1. Gently pull the cord out of the slot on the back as shown.

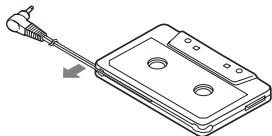

2. Change the cord exit location (back or either side of the pack). Push the cord back into the slot.

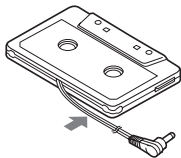

Using in a car

1. Plug the cord into the LINE OUT socket.
2. Insert the pack with "THIS SIDE UP/HAUT" side up into tape slot of the car stereo.

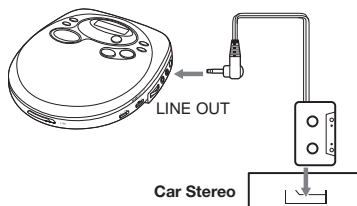

or

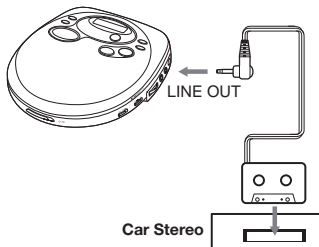

USING THE LINE OUT SOCKET

To record from the CD player

Connect the patch cable (not supplied) from the LINE OUT socket on the unit to the LINE INPUT socket on a cassette recorder.

To hear through a pair of speakers

Connect the patch cable (not supplied) from the LINE OUT socket on the unit to the AUX or CD INPUT sockets on a stereo system.

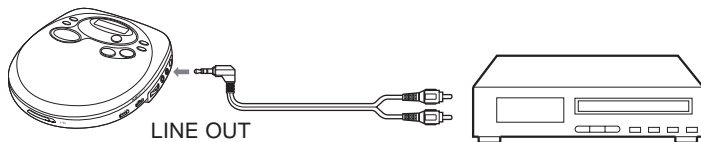

CLEANING

Cleaning the pickup lens

Dust on the pickup lens can lead to erratic operation and interruption of the sound during play.

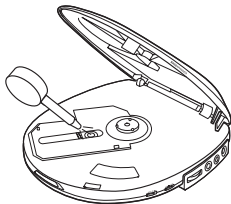

- To clean the pickup lens, open the disc compartment lid. Blow the dust off of the lens using a camera lens blower (available at most camera stores).
- Do not touch the surface of the lens.

Cleaning the cabinet

Use a soft cloth moistened with plain lukewarm water and wrung dry. Never use benzol, benzene or other strong chemical cleaners.

SPECIFICATIONS

Channels:	2 channels
S/N ratio:	60 dB
Wow and flutter:	undetectable
Sampling frequency:	44.1 kHz
Pickup light source:	Semiconductor laser
Pickup wave length:	790 nm
Laser output:	0.5 mW (continuous wave max.)
Terminal impedance:	PHONES: 16 - 32 ohms LINE OUT: 47 kohms
Power source:	DC: 6V (AC adaptor or Cigarette lighter adaptor) DC: 3V (Ni-Cd battery NBP-50A or AA x 2)
Dimensions:	133 x 34 x 142 mm (W x H x D)
Weight:	Approx. 220g without batteries

Specifications subject to change without notice.

1AD6P1P1251--
(AU)

SANYO

SANYO Electric Co., Ltd.
Printed in China