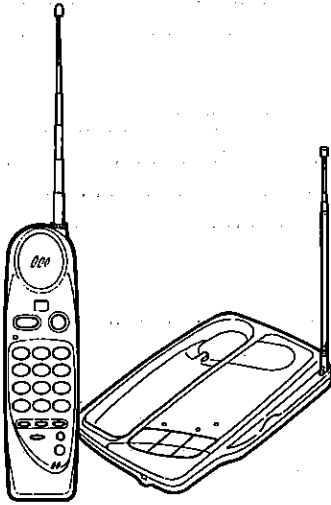

# SANYO

## INSTRUCTION MANUAL

## CLT-5780AUS

### Cordless Telephone

**CAUTION**

THIS CORDLESS TELEPHONE IS INTENDED FOR USE IN AUSTRALIA ONLY.  
SALE OR USE IN OTHER COUNTRIES MAY VIOLATE LOCAL LAWS.

**IMPORTANT  
HANDSET BATTERY PACK**

Charge the handset battery pack for a full 12 hours before using your cordless phone for the first time.

# TABLE OF CONTENTS

<b>INTRODUCTION</b> .....	2
<b>ACCESSORIES</b> .....	2
<b>NAMES OF CONTROLS</b>	
HANDSET .....	3
BASE STATION .....	5
<b>PREPARATION</b>	
AC CONNECTION & PHONE LINE CONNECTION .....	7
FLASH/EARTH SETTING SWITCH .....	8
WALL MOUNTING .....	9
INSTALLING THE BATTERY PACK .....	10
CHARGING THE BATTERY PACK .....	11
INITIAL SETUP .....	12
BEFORE MAKING A CALL .....	13
<b>GENERAL OPERATION</b>	
5-CHANNEL ACCESS .....	14
RECEIVING LEVEL CONTROL .....	14
<b>BASIC USE</b>	
ANSWERING AN INCOMING CALL .....	15
PLACING A CALL .....	16
AUTODIAL .....	17
REDIAL .....	18
<b>ADVANCED USE</b>	
INSTANT TONE .....	19
FLASH BUTTON .....	19
INTERCOM	
From Handset to Base station .....	20
From Base station to Handset .....	20
How to use for room monitoring .....	21
HOLD BUTTON .....	21
TRANSFERRING A CALL .....	22
<b>MAINTENANCE</b> .....	23
<b>TROUBLESHOOTING</b> .....	23
<b>MALFUNCTIONS</b> .....	24

# INTRODUCTION

Your SANYO cordless telephone operates on the same principle as a two-way radio. The location of the base station determines the range of reception. In most homes, maximum range is obtained by locating the base station at the highest point in the house.

Once installed on a Touch-Tone or pulse dialing phone line, the telephone operates like any other, but without the limitations of a cord.

This cordless telephone consists of an electronic base station with a built-in charger, and a compact push-button handset.

The base station operates from a 240 volt AC electrical outlet. Connect the base station to a telephone line by simply plugging it into a standard telephone jack. The handset is powered by a heavy-duty rechargeable battery pack.

This SANYO cordless telephone is Hearing-Aid compatible.

## Notice:

This cordless telephone uses radio communication between the handset and the base station and may not ensure privacy of communication.

Other devices, including other cordless telephones, may interfere with the operation of this cordless telephone or cause noise during operation.

Cordless telephones must not cause interference to any licensed radio service.

# ACCESSORIES

Antenna



Telephone Cord



Number Memory Index Sheet

SPEED DIAL	
M1	
M2	
M3	
M4	
M5	
M6	
M7	
M8	
M9	
M0	

  

SPEED DIAL	
M1	
M2	
M3	
M4	
M5	
M6	
M7	
M8	
M9	
M0	

AC Adaptor  
(Model No. KR0522)

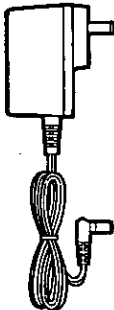

Battery Pack

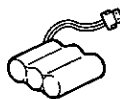

Wall Mount Hanger

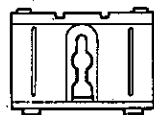

# NAMES OF CONTROLS

## HANDSET

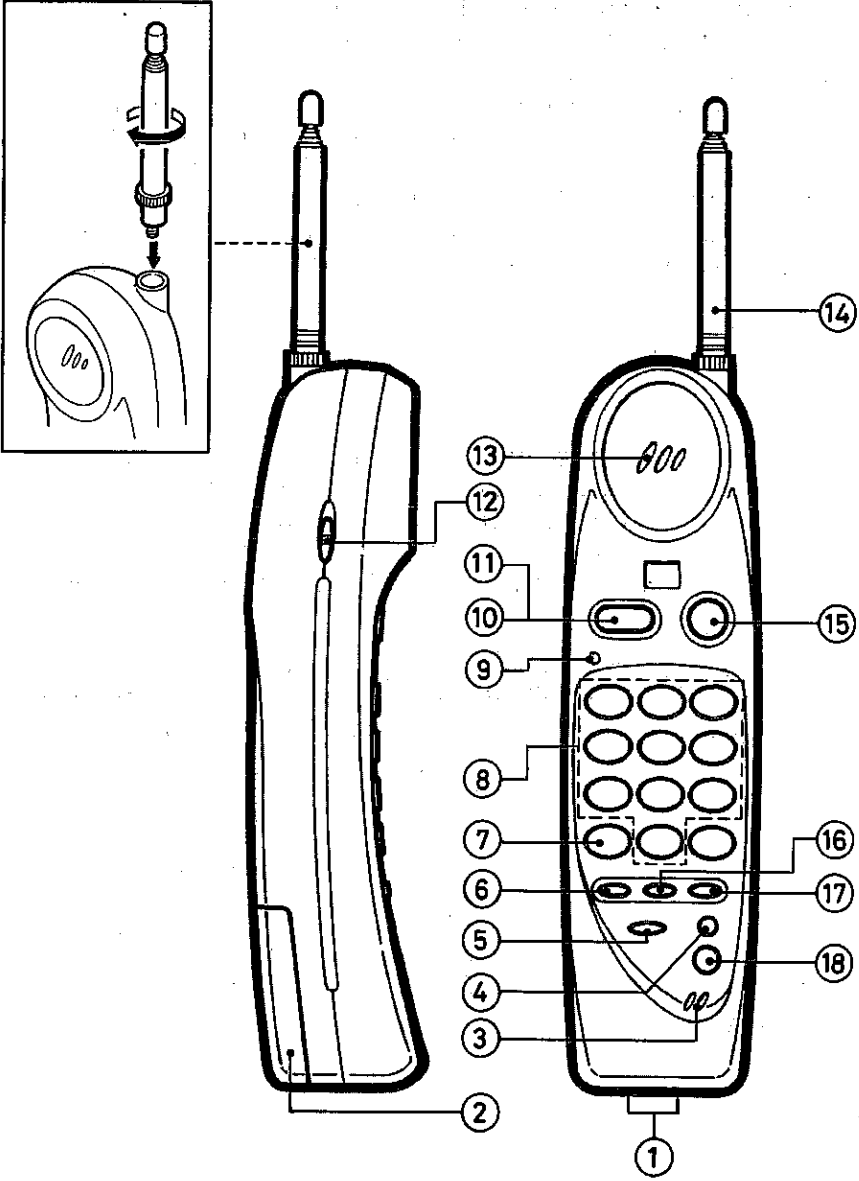

## HANDSET

- ① **Contact Points**  
For battery pack charging.
- ② **Battery compartment**
- ③ **Microphone**
- ④ **HOLD Button**  
Press to temporarily place a call on hold without disconnecting the other party.
- ⑤ **INT (intercom) Button**  
Press to begin an intercom conversation with the base station.
- ⑥ **FLASH Button**  
Works like a temporary hook switch.  
Also used to access EASY CALL services offered by TELECOM etc (call waiting, for example).
- ⑦ **TONE/\* Button**  
Press to change the dialing mode temporarily from pulse to tone.
- ⑧ **Dialing Buttons**  
Use just like the buttons on a standard Touch-Tone phone.
- ⑨ **BATT LOW indicator**  
Lights when the battery pack needs recharging.  
(If the battery pack is completely exhausted, this indicator does not light.)
- ⑩ **TALK (/VOLUME) Button**  
Press to receive an incoming call or to place an outgoing call.  
Also used to change the receiving level (normal or loud) from the handset speaker.
- ⑪ **TALK indicator**  
Lights when the handset is in talk mode..
- ⑫ **RINGER Switch**  
Turns the ring on and off.  
This switch must be set to the "on" position in order to hear a ring when an incoming call is received.  
If the ringer disturbs you, set to the "off" position. The ring will be muted.
- ⑬ **Earpiece**
- ⑭ **Antenna**
- ⑮ **END Button**  
Press to hang up and place the telephone in the standby mode.
- ⑯ **MEMORY Button**  
Press to store phone numbers in memory or to recall a stored phone number.
- ⑰ **REDIAL/P (pause) Button**  
Press to redial the last number dialed.  
If you press any other dialing button before pressing this button, it functions as a pause button.
- ⑱ **SCAN Button**  
Press to change the channel if you hear noise or interference during a call.

# NAMES OF CONTROLS

## BASE STATION

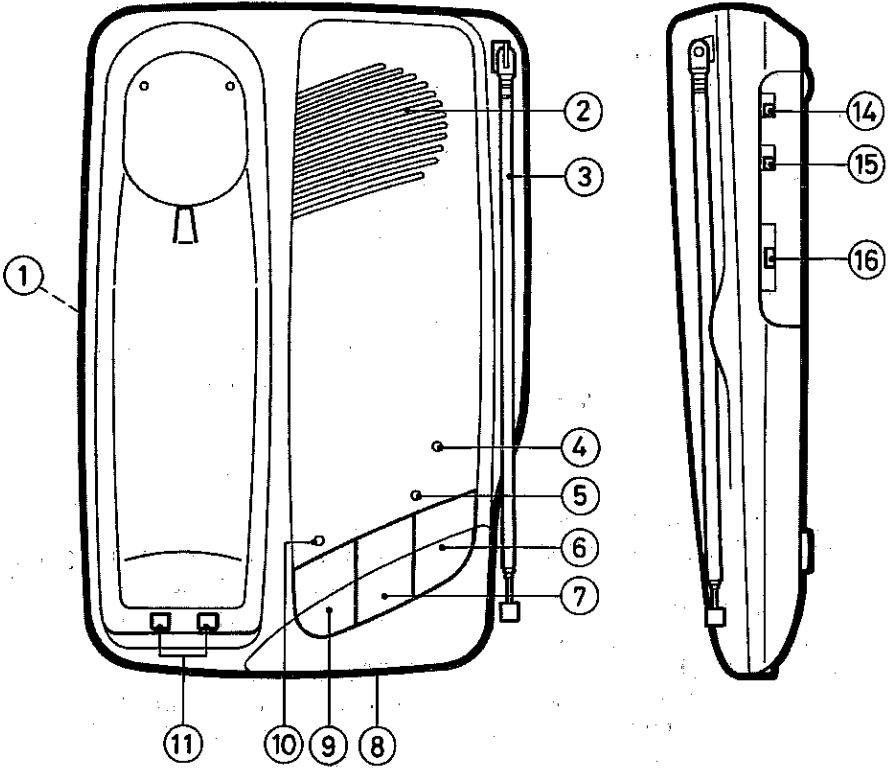
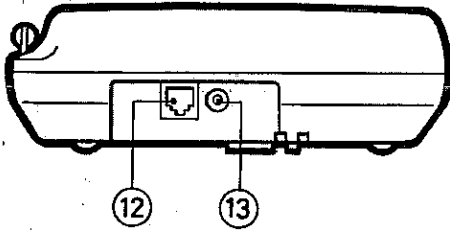

## BASE STATION

- ① **FLASH/EARTH** Setting Switch  
Located on the bottom side of unit. As shown in page 8.
- ② **Speaker**
- ③ **Antenna**  
For optimum performance, extend fully in a vertical position.
- ④ **IN USE/CHARGE** Indicator  
Lights when the handset is in talk mode.  
Also lights when the handset battery pack is being recharged in the base station cradle.
- ⑤ **SPEAKER** Indicator  
Lights when the speakerphone is used.
- ⑥ **SPEAKER** Button  
Press to turn the speakerphone on and off.
- ⑦ **HOLD** Button  
Press to temporarily place a call on hold without disconnecting the other party.
- ⑧ **Microphone**
- ⑨ **PAGE/INT** (intercom) Button  
Press to begin an intercom conversation with the handset.  
Also used to reset the security code.
- ⑩ **PAGE/INT** Indicator  
Lights when the intercom is in use.
- ⑪ **Contact Points**  
For battery pack charging.
- ⑫ **Modular Telephone Jack (TEL LINE)**
- ⑬ **AC Adaptor Jack (AC ADAPTOR/DC 9V)**
- ⑭ **TONE/PULSE** Select Switch
- ⑮ **RINGER** Switch  
Turns the base station ring on and off.  
This switch must be set to the **ON** position in order to hear a ring when an incoming call is received. If the ringer disturbs you, set to the **OFF** position. The ring will be muted.
- ⑯ **VOLUME** Control  
Adjusts the sound level from the speaker.

# PREPARATION

## AC CONNECTION & PHONE LINE CONNECTION

1. Insert the small plug on the end of the AC adaptor cord into the AC ADAPTOR jack on the back of the base station.
2. Plug the AC adaptor into an AC wall outlet.
3. Plug the telephone line cord.

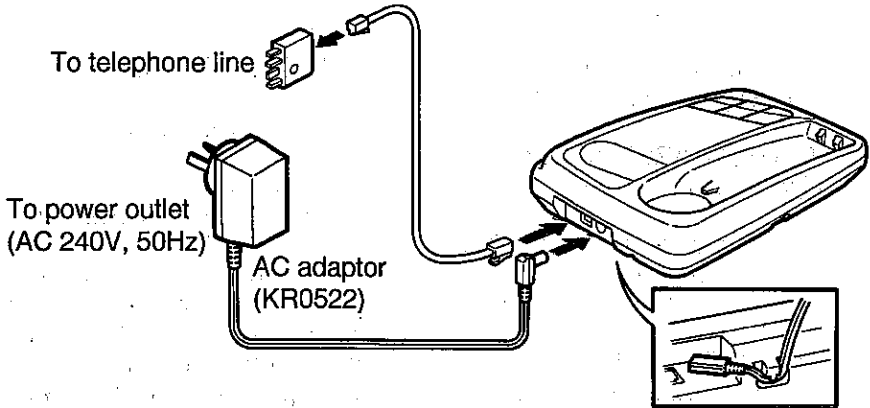

### NOTE:

**USE ONLY SANYO AC ADAPTOR MODEL NO. KR0522 (APPROVAL NO. Q92103).**

If the plug of your Telecom telephone cannot be readily removed, you will have to remove the screw securing it. To do this proceed as follows:

1. Loosen screw "A" sufficiently to remove the socket cover.
2. Remove screw "B" and withdraw the plug.
3. Replace screw "B". Ensure that it screws completely into the socket recess. (If the screw is too long, increase the hole depth or replace the screw with one 5 mm shorter.)
4. Replace socket cover and tighten screw "A".

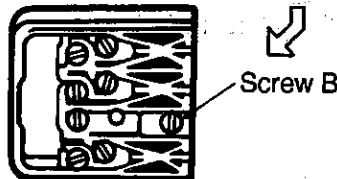
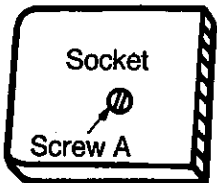
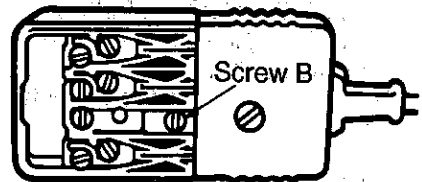
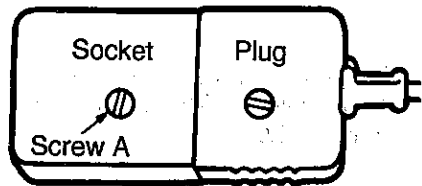



## Ringer Equivalence Number: 0.2

## Party Line or Pay Phone

If you have a party line or a pay phone, telephone companies do not allow the installation of cordless telephones, because they will not work correctly with these systems.

### FLASH/EARTH SETTING SWITCH

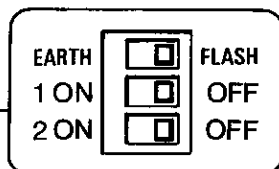

You can set the FLASH TIME (90 - 600 msec) depending on your PBX phone system.

### FLASH function

1. Set the FLASH/EARTH switch to the FLASH position.
2. Select "ON" or "OFF" in accordance with required FLASH TIME.

#### NOTE:

- There are four choices available, 90, 250, 400 and 600 msec.
- The timing of FLASH signal is preset to "90 msec".
- Please use a pointed end such as a pen.

	<table border="1"> <tr> <td>EARTH</td> <td><input type="checkbox"/></td> <td>FLASH</td> </tr> <tr> <td>1 ON</td> <td><input type="checkbox"/></td> <td>OFF</td> </tr> <tr> <td>2 ON</td> <td><input type="checkbox"/></td> <td>OFF</td> </tr> </table>	EARTH	<input type="checkbox"/>	FLASH	1 ON	<input type="checkbox"/>	OFF	2 ON	<input type="checkbox"/>	OFF	<table border="1"> <tr> <td>EARTH</td> <td><input type="checkbox"/></td> <td>FLASH</td> </tr> <tr> <td>1 ON</td> <td><input type="checkbox"/></td> <td>OFF</td> </tr> <tr> <td>2 ON</td> <td><input type="checkbox"/></td> <td>OFF</td> </tr> </table>	EARTH	<input type="checkbox"/>	FLASH	1 ON	<input type="checkbox"/>	OFF	2 ON	<input type="checkbox"/>	OFF	<table border="1"> <tr> <td>EARTH</td> <td><input type="checkbox"/></td> <td>FLASH</td> </tr> <tr> <td>1 ON</td> <td><input type="checkbox"/></td> <td>OFF</td> </tr> <tr> <td>2 ON</td> <td><input type="checkbox"/></td> <td>OFF</td> </tr> </table>	EARTH	<input type="checkbox"/>	FLASH	1 ON	<input type="checkbox"/>	OFF	2 ON	<input type="checkbox"/>	OFF	<table border="1"> <tr> <td>EARTH</td> <td><input type="checkbox"/></td> <td>FLASH</td> </tr> <tr> <td>1 ON</td> <td><input type="checkbox"/></td> <td>OFF</td> </tr> <tr> <td>2 ON</td> <td><input type="checkbox"/></td> <td>OFF</td> </tr> </table>	EARTH	<input type="checkbox"/>	FLASH	1 ON	<input type="checkbox"/>	OFF	2 ON	<input type="checkbox"/>	OFF
EARTH	<input type="checkbox"/>	FLASH																																						
1 ON	<input type="checkbox"/>	OFF																																						
2 ON	<input type="checkbox"/>	OFF																																						
EARTH	<input type="checkbox"/>	FLASH																																						
1 ON	<input type="checkbox"/>	OFF																																						
2 ON	<input type="checkbox"/>	OFF																																						
EARTH	<input type="checkbox"/>	FLASH																																						
1 ON	<input type="checkbox"/>	OFF																																						
2 ON	<input type="checkbox"/>	OFF																																						
EARTH	<input type="checkbox"/>	FLASH																																						
1 ON	<input type="checkbox"/>	OFF																																						
2 ON	<input type="checkbox"/>	OFF																																						
<b>FLASH TIME</b>	90 msec	250 msec	400 msec	600 msec																																				

### EARTH function

1. Set the FLASH/EARTH switch to the EARTH position.
  - The other switches has nothing to do with the length of EARTH TIME.

	<table border="1"> <tr> <td>EARTH</td> <td><input type="checkbox"/></td> <td>FLASH</td> </tr> <tr> <td>1 ON</td> <td><input type="checkbox"/></td> <td>OFF</td> </tr> <tr> <td>2 ON</td> <td><input type="checkbox"/></td> <td>OFF</td> </tr> </table>	EARTH	<input type="checkbox"/>	FLASH	1 ON	<input type="checkbox"/>	OFF	2 ON	<input type="checkbox"/>	OFF	NOT USE
EARTH	<input type="checkbox"/>	FLASH									
1 ON	<input type="checkbox"/>	OFF									
2 ON	<input type="checkbox"/>	OFF									
<b>EARTH TIME</b>	400 msec										

#### NOTE:

For further details, consult with your telephone company or operating instructions of your PBX.

## WALL MOUNTING

### To mount the base station on a wall

1. Insert the hooks of the wall mount hanger in the holes in the back of the base station.

Then push them in the direction of arrow ② as shown.

2. Connect the cord.
3. Mount the base station on the wall.

Wall mount hanger

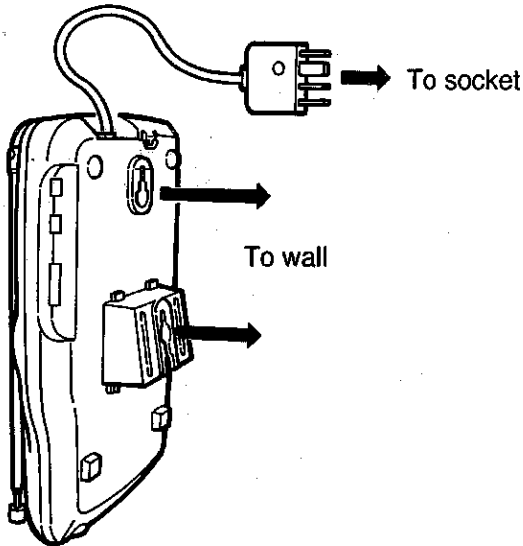
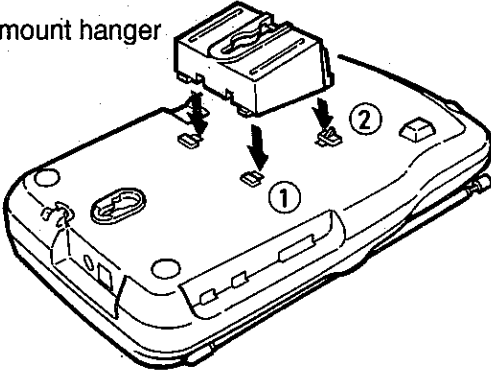

## INSTALLING THE BATTERY PACK

1. Remove the battery compartment lid.

2. Plug the battery pack cord into the connector inside the battery compartment. Place the battery pack in the battery compartment.

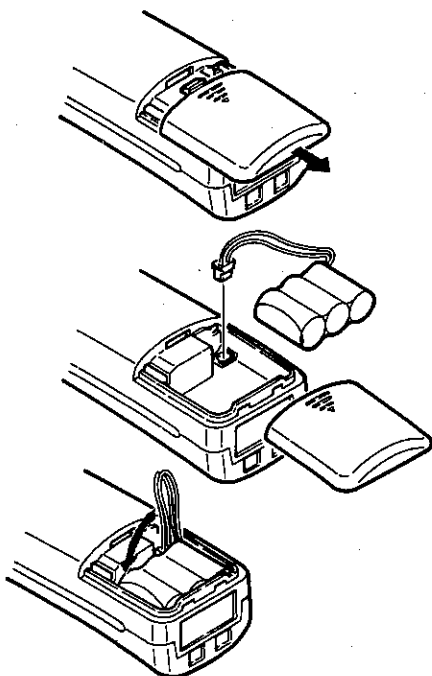

3. Replace the lid by sliding it up over the pack until it is firmly in place.

### NOTES:

- When you replace the battery pack, press END before step 1 above.
- If the battery pack is replaced, the security code and any stored phone numbers for AUTODIAL will be cleared and must be reset.

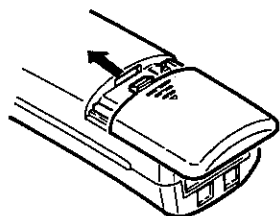

Replacement battery pack part number: **SANYO 3N-270AA**

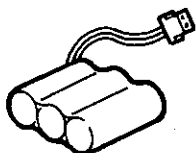

3N-270AA

### NOTE:

When batteries are discharged, they must be disposed of in a safe manner that complies with all applicable laws.

## CHARGING THE BATTERY PACK

### IMPORTANT:

Charge the handset before using the cordless phone for the first time. Do not attempt to use the phone before charging the battery pack for a full 12 hours.

1. Place the handset on the base station and charge it for a full 12 hours.
2. Remove the handset from the base station.
3. Press TALK and make certain the BATT LOW indicator does not light. (The BATT LOW indicator lights when the handset needs recharging.) From then on, recharge the battery pack by placing the handset in the base station cradle when the BATT LOW indicator lights.

If the battery pack fails, replacement battery packs are available from any authorized SANYO service center.

(Replacement battery pack: SANYO 3N-270AA)

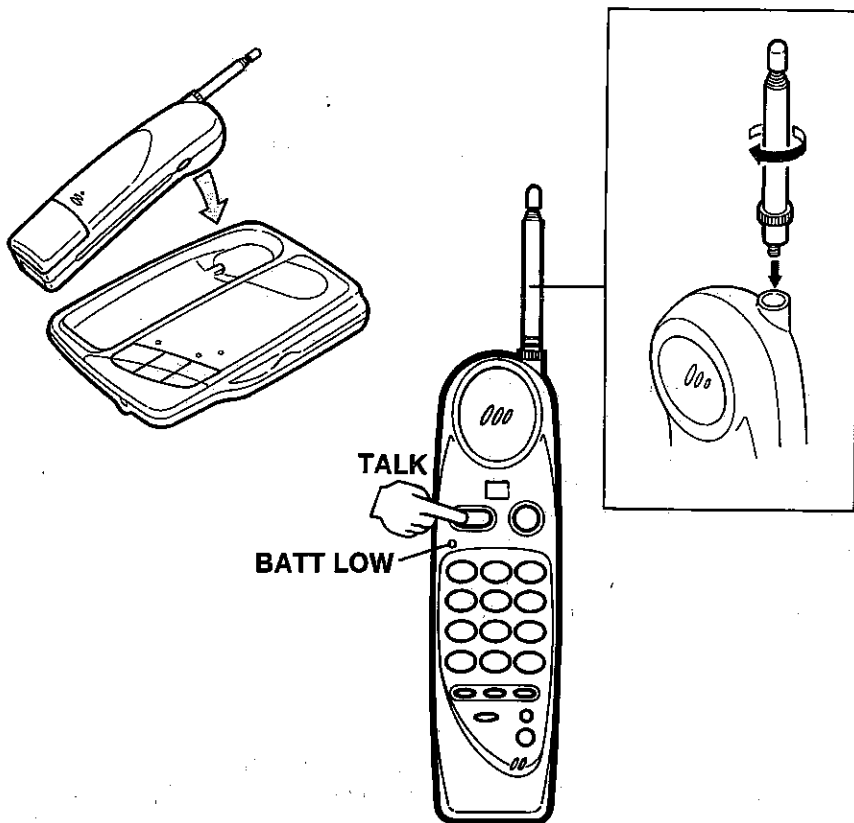

# INITIAL SETUP

## DIALING SYSTEM

Set the TONE/PULSE switch on the base station to the dialing system used in your area (tone or pulse).

If you do not know which system is in use, ask your phone company.

## SECURITY CODE

This cordless telephone has a digital security system with 10,000,000 possible codes. This system helps prevent the unauthorized use of your telephone line by another cordless telephone.

If at some time you hear a high-pitched tone in the handset instead of a dial tone, reset the security code as follows.

### How to reset your security code

1. Place the handset in the base station cradle.
2. Press PAGE on the base station (within 3 seconds).

A beep sounds. The security code is now set.

### NOTES:

- To change your security code at any time, simply repeat the above steps. A new security code is automatically set each time.
- If the security code cannot be set properly, disconnect the AC adaptor from the unit, then re-connect it.

### IMPORTANT:

The security code must be reset under following situations.

- If there is a power failure
- If the AC adaptor is disconnected
- If the handset battery pack is replaced
- If the handset battery pack is exhausted

If these happen, the security code has been cleared, and calls cannot be made until the code is reset.

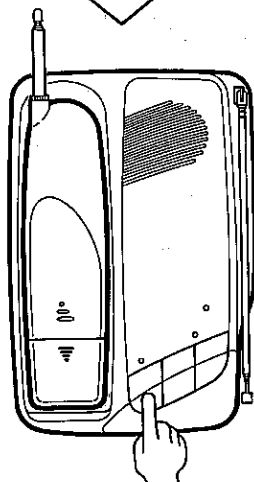
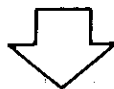
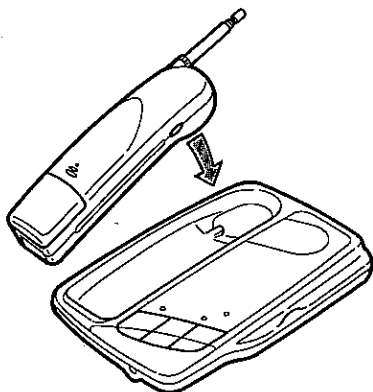
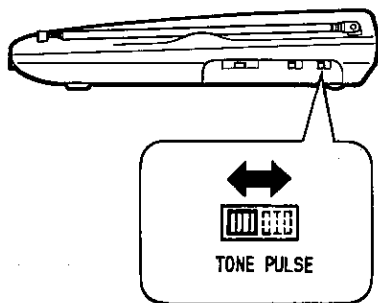

PAGE

## BEFORE MAKING A CALL

1. Extend the antenna of the base station full-length.
2. Take the handset to the location where you want to use it.
3. Extend the antenna of the handset full-length.
4. Press TALK, making certain that you get a dial tone and that the TALK indicator lights.
5. Press END to return the handset to standby mode.

### NOTE:

If the phone does not work properly, check the system connections and the operating range. (If the BATT LOW indicator is lit, charge the handset.)

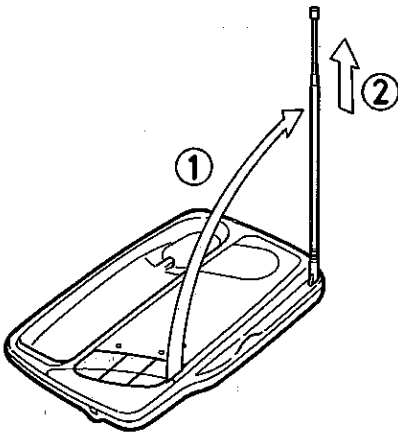

## GENERAL OPERATION

### 5-CHANNEL ACCESS

This cordless telephone is capable of operating on 5 different channels. If you experience interference during a call, simply select a different channel by pressing SCAN.

#### NOTE:

When there is excessive signal noise or interference, pressing SCAN may not improve signal quality. If conversation becomes impossible, follow the instructions below.

1. Place the handset in the base station cradle.
2. Lift the handset and press END.
3. Press SCAN.
4. Place the handset in the base station cradle.
5. Press PAGE/INT on the base station (within 3 seconds).

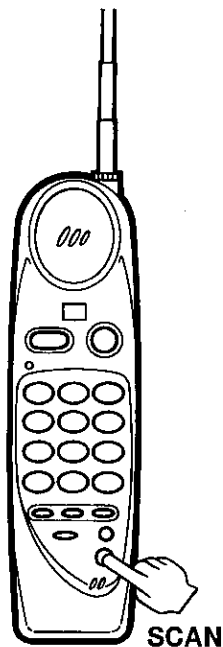

### RECEIVING LEVEL CONTROL

If it is difficult to hear the caller's voice while talking, press TALK to increase the volume from the handset speaker.

#### NOTES:

- To return the volume to normal, press TALK again.
- The next call will return to the normal level, even if the last call ends in the high level setting.
- This function does not operate during intercom conversation.



## BASIC USE

### ANSWERING AN INCOMING CALL

#### Using the Handset

When a call comes in, the dialing buttons on the handset flash.

1. Press TALK (or pick up the handset from the base station).
2. Talk.
3. Press END to hang up (or return the handset to the base station.)

#### NOTES:

- If the RINGER switch is set to the "off" position, no ring is heard when an incoming call is received.
- The cordless handset may ring slightly after the base station.
- If the handset is too far away from the base station, pressing END may not hang up a call. If this happens, come closer to the base station and then press END, or simply return to the base station and place the handset in the base station cradle.

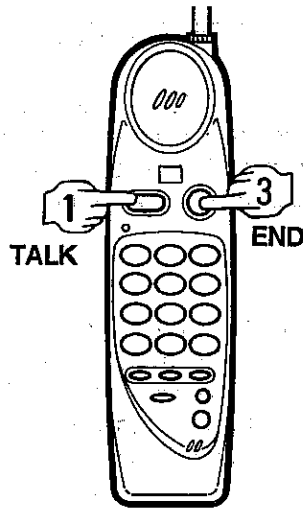

#### Using the Base station (speaker phone)

1. Press SPEAKER.  
The SPEAKER indicator lights.
2. Talk into the microphone.  
The caller's voice is heard from the speaker.
3. Press SPEAKER again to hang up.

#### NOTES:

- If the RINGER switch is set to the OFF position, no ring is heard when an incoming call is received.
- You can answer an incoming call with or without the handset in the cradle.

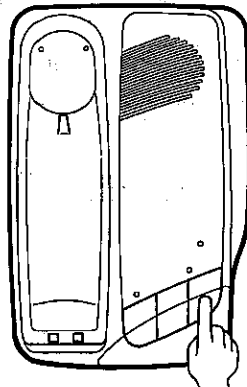

**SPEAKER**

#### Auto Standby

After finishing a call, you can hang up by simply returning the handset to the base station cradle. The handset automatically switches from talk mode to standby mode. This feature lets you use the handset like a regular corded telephone (without pressing END). To answer the next call, simply pick up the handset and talk.

#### NOTE:

When you remove the handset from the base station cradle, the phone automatically enters talk mode. (This means that if someone tries to call you the line will be busy.) To return to standby mode, press END.



## PLACING A CALL

1. Press TALK (or pick up the handset from the base station).  
The TALK indicator lights, and the dialing buttons light for approximately 10 seconds.
  - The dialing buttons light for another 10 seconds after any button (except HOLD, INT and END) on the handset is pressed.
2. Dial the number you want to call.  
If you make an error in dialing the number, press END, then press TALK to get a dial tone.
3. Press END to hang up (or return the handset to the base station).

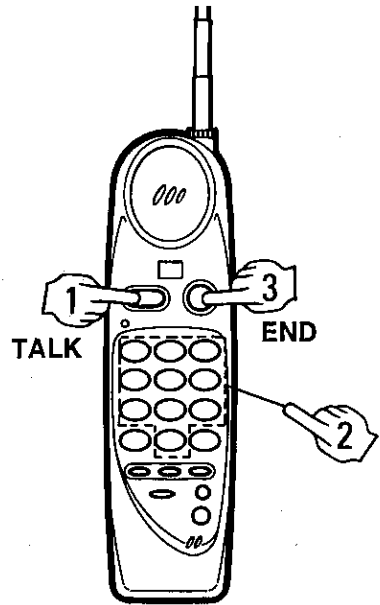

# AUTODIAL

## To store numbers

You can store up to 10 frequently called phone numbers in your cordless telephone's memory. Stored phone numbers can include pauses where necessary. (See below.)

1. Press END.
2. Press MEMORY.
  - The TALK indicator flashes, and the dialing buttons light for approximately 10 seconds.
  - The dialing buttons light for another 10 seconds after any button on the handset is pressed.
3. Dial the phone number you want to store.
4. Press MEMORY.
5. Press a number button to designate an index number ("0" - "9").
  - An audible tone sounds and the dialing buttons go off. The phone number is now stored in your cordless telephone's memory.
6. Write the stored phone number on the number memory index sheet.
7. Repeat steps 2 - 6 to store other numbers or to change previously stored numbers.

## NOTES:

- To insert a 2-second pause between two digits in a stored number (after "9" to get an outside line in a PBX system, for example), press REDIAL/P after the first digit.
- Phone numbers up to 16 digits in length can be stored. (A pause counts as one digit.)

## To call a number stored in the memory

1. Press TALK.
2. Press MEMORY.
3. Press the assigned index number ("0" - "9").

The autodial memory will be cleared if:

- The handset battery pack is replaced.
- The handset battery pack is exhausted.

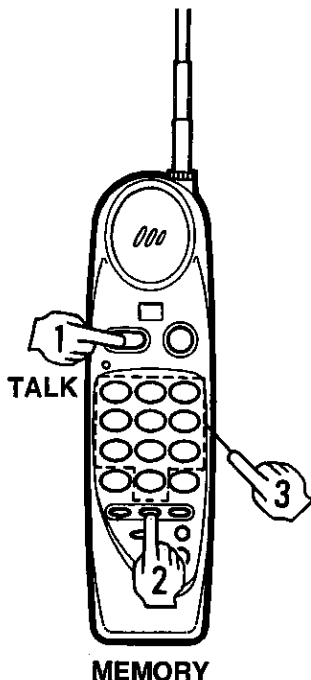
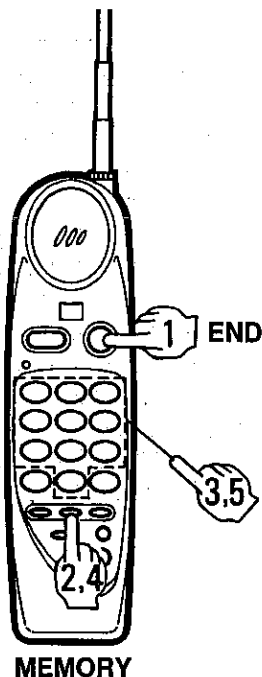

## REDIAL

You can automatically redial the last number called. Simply press REDIAL/P. The last number dialed is automatically redialed. (A number of up to 32 digits can be redialed.)

### NOTE:

To redial after hearing a busy signal, press END, then TALK, then REDIAL/P.

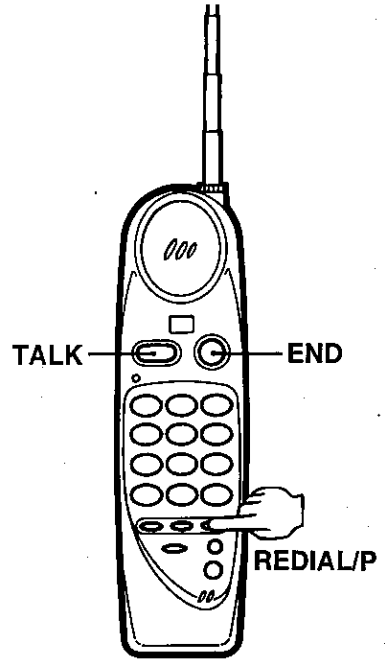

### INSTANT TONE

If your home is equipped with pulse dialing and your phone is set to pulse mode, you can change to Touch-Tone dialing temporarily. This allows you to access special services available to Touch Tone lines (electronic banking systems and remote-control answering machines, for example).

1. Dial the number you want to call.
2. When your call is answered, press “\*”.

The telephone stays in tone mode until the call ends. Then it returns automatically to pulse mode.

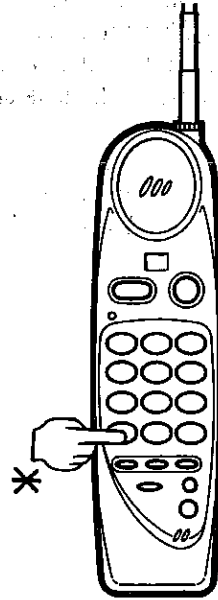

### FLASH BUTTON

You can use the FLASH button to access special services offered by your phone company (EASY CALL and PBX, for example).

If you subscribe to EASY CALL...

1. If a call comes in when you are already on the phone, an audible tone sounds.
2. Follow the instructions supplied by the phone company for the service for example : FLASH “...”

You can talk to the second caller.

3. Press FLASH “...” again.

The second caller is placed on hold, and you can talk to the first caller.

#### NOTE:

The FLASH button may also be used to get a new dial tone without pressing END or replacing the handset in the base station cradle. However, if your telephone line has special service features (like call waiting), the FLASH button may not operate in this way.

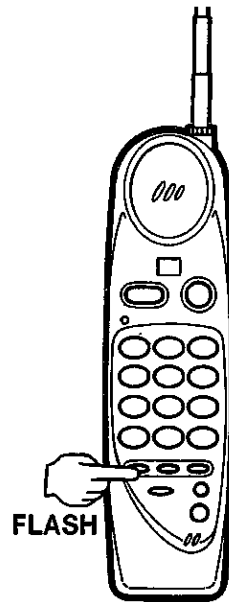

# INTERCOM

## From Handset to Base station (Auto Intercom)

1. Handset: Press END.
2. Handset: Press INT to page the base station.  
Base station automatically switches to intercom mode.
3. Handset/Base station: Begin intercom conversation.
4. Handset: Press END to turn off the intercom.

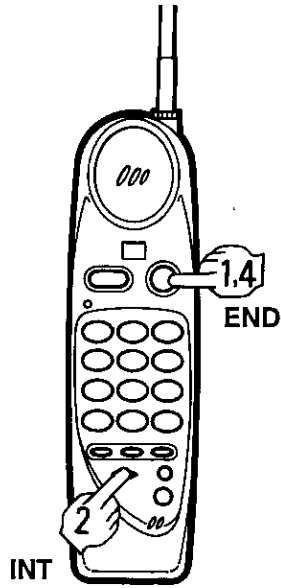

## From Base station to Handset

When the handset is paged by the base station, the dialing buttons on the handset will flash during paging.

1. Base station: Press PAGE/INT to page the handset.
2. Handset: Press TALK and begin intercom conversation.
3. Handset: Press END to turn off the intercom.

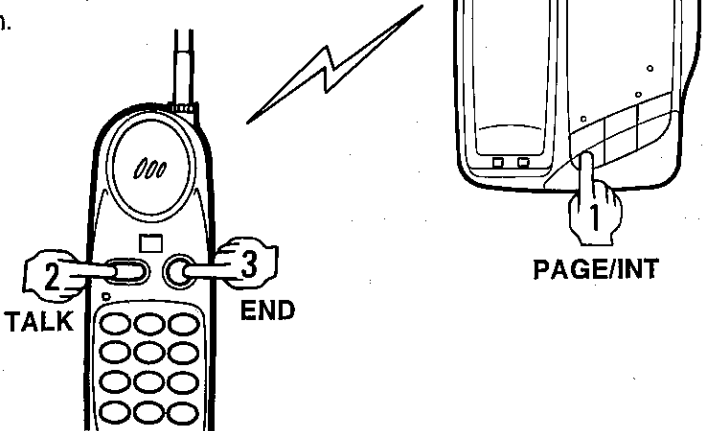

### How to use for room monitoring

The handset user can monitor the ambient sound of the room where the base station is located.

1. Press END.
  2. Press INT to begin monitoring.
  3. Press END to end monitoring.
- To improve the clarity of the monitor sound, cover the handset microphone with your hand.

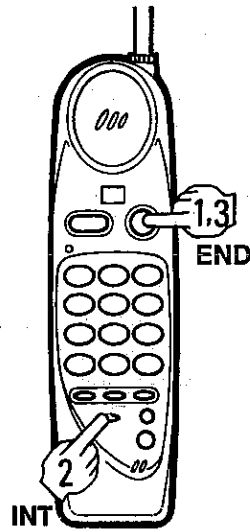

### HOLD BUTTON

You can use the HOLD button to place a call on hold.

#### When using the Handset

1. Press HOLD to place a call on hold.  
The TALK indicator flashes.
2. Press TALK to return to the call.  
The TALK indicator lights.

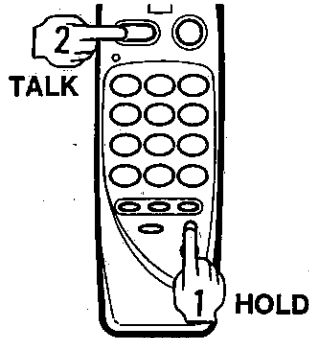

#### When using the Base station

1. Press HOLD to place a call on hold.  
The SPEAKER indicator flashes.
2. Press SPEAKER to return to the call.  
The SPEAKER indicator lights.

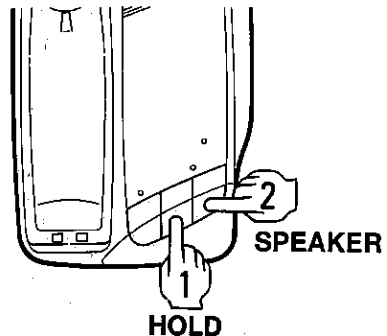

## TRANSFERRING A CALL

A call can be transferred between the handset and the base station.

### From Handset to Base station

1. Handset: Press INT to alert the base station.  
The call is put on hold.  
Speak to the base station user.
2. Base station : Press SPEAKER and talk to the caller using the speakerphone.
3. Handset: Press END to hang up.  
(If the base station does not answer, press TALK to talk to the caller again.)

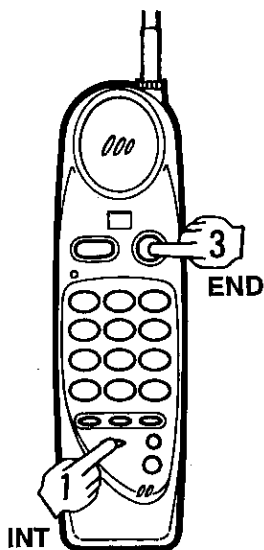

### From Base station to Handset

1. Base station: Press PAGE/INT to alert the handset user.
2. Handset: Press TALK to answer the base station, then press TALK to talk to the caller.
3. Base station: (If the handset does not answer, press SPEAKER to talk to the caller again.)

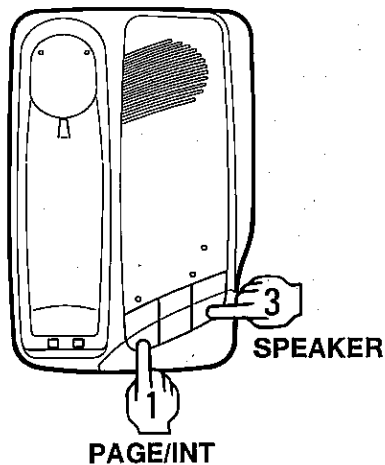

## MAINTENANCE

### CLEANING THE CONTACT POINTS

To ensure that the handset battery pack charges properly, clean the contact points on the handset and the base station once a month by wiping them with a soft cloth.

### CAUTION

During a lightning storm, or when the unit will not be in use for an extended period, you should disconnect it from the telephone line and unplug it from the AC outlet.

## TROUBLESHOOTING

The phone does not work:

- AC adaptor may not be plugged into wall outlet.
- Battery pack may need recharging (if BATT LOW indicator lights in talk mode).
- Security code may not be set properly.
- Handset may be too far from base station.

The communication range becomes shorter:

- Handset may need recharging.

Incoming calls do not ring on the handset:

- Handset may be too far from base station.
- RINGER switch may be set to OFF position.



## MALFUNCTIONS

Although it is very unusual for the base station to malfunction, if it does occur, disconnect it from the telephone line until proper repairs are completed.

The cordless telephone uses radio frequencies for transmission and reception, and is subject to certain operating conditions. The following conditions are normal and could affect the operation of your system.

### 1. NOISE

Electrical pulse noise is present in most homes at one time or another. This is most intense during electrical storms. Certain kinds of electrical equipment such as light dimmers, fluorescent bulbs, motors, fans, etc., also generate these noise pulses. Because radio frequency transmissions are susceptible to these pulses, on occasion you may hear them in your handset. Generally they are a minor annoyance and should not be interpreted as a defect in your system.

### 2. RANGE

Because radio frequencies are used, the location of the base station can affect the operation range. Try several locations in your home or business and pick the one that gives you the clearest signal to the handset. Turning around while holding the handset may help you find the best position.

### 3. INTERFERENCE

Electronic circuits activate a relay to connect the cordless telephone to your telephone line. These electronic circuits operate in the radio frequency spectrum. While several protection circuits are used to prevent unwanted signals, there may be periods when these unwanted signals enter the base station. You may hear clicks or hear the relay activate while you are not using the cordless handset. If this starts occurring frequently, it can be minimized or eliminated by lowering the height of your base station antenna, or relocating the base station. Check for interference before selecting your final base station location by plugging it in and monitoring it for clicks.

Two cordless systems should not be operated too close to each other because of interference. This interference can be reduced by lowering your base station antenna, thereby reducing its range, or by changing the security code settings.



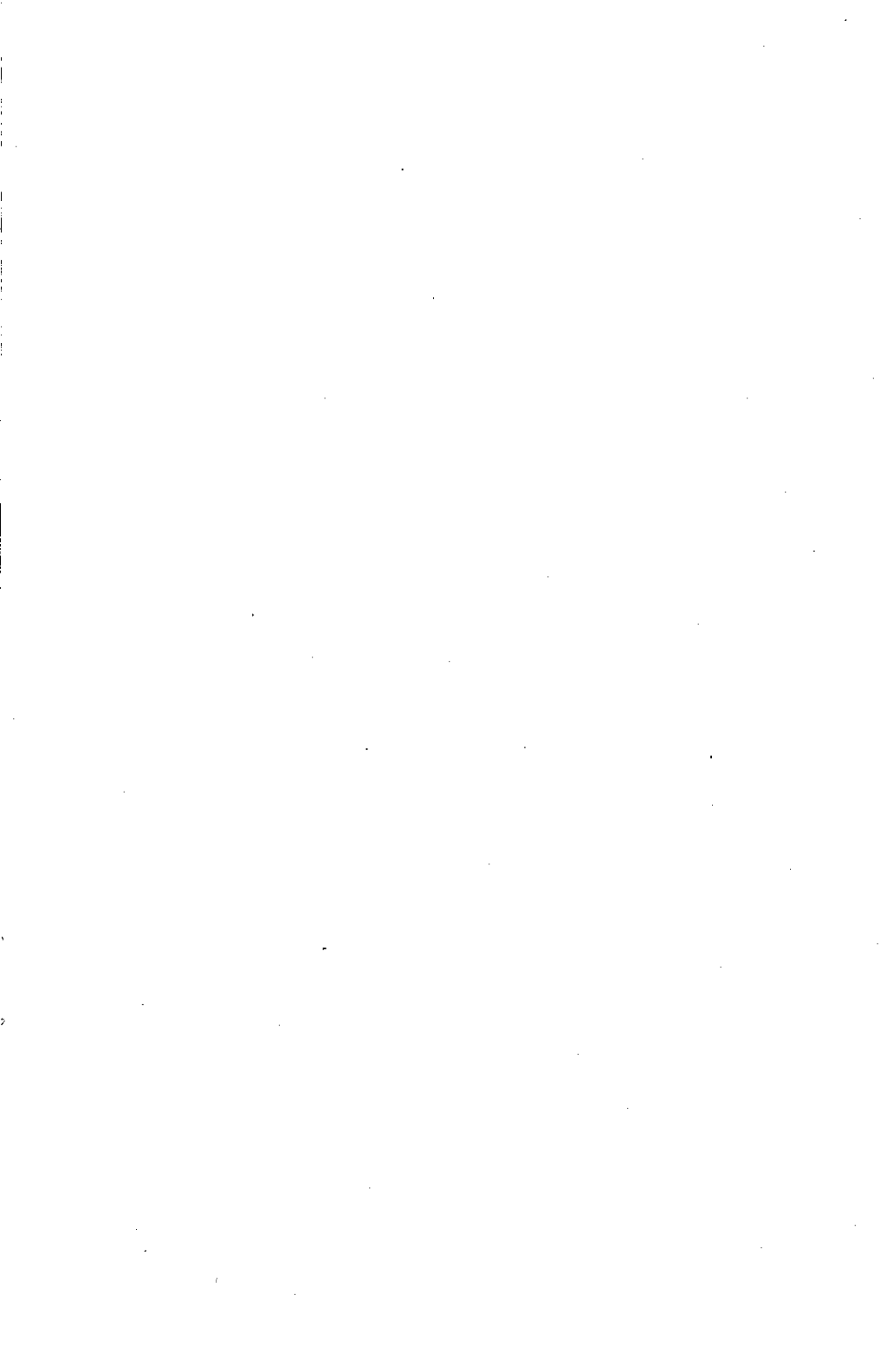

1AD6P10A32904  
(AU)

**SANYO**

---

**SANYO Electric Co., Ltd.**  
Printed in Hong Kong