

SANYO

INSTRUCTION MANUAL

CLT-9650

Cordless telephone

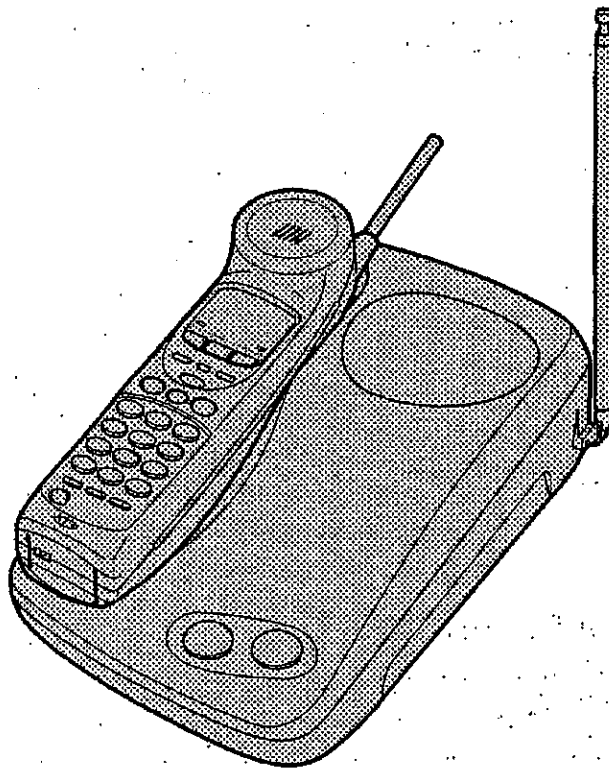

Congratulations

Your SANYO COMPANDER PLUS cordless telephone is a fine-quality home communications product. It is carefully designed and produced by a world leader of consumer and industrial electronics equipment. With proper maintenance and care, it will provide you with years of enjoyment and convenience.

Table of contents

SETTING UP

UNPACKING	2
NAMES OF CONTROLS	3
INSTALLATION	7
Location	
Connections	
CHARGING THE HANDSET BATTERY	9

BASIC USE

PLACING A CALL	10
ANSWERING A CALL	11
USING THE SPEAKERPHONE	12

ADVANCED USE

HOLD	13
MUTE	13
REDIAL	14
AUTO DIAL	15
SPEED DIAL	16
INTERCOM	18
TRANSFERRING A CALL	19
FLASH BUTTON	20
TEMPORARY TONE DIALING	20
CALL WAITING	21

GENERAL

REPLACING HANDSET BATTERY	22
WALL MOUNTING	23
TROUBLESHOOTING	24
SECURITY CODE	25
TECHNICAL INFORMATION	26

Read this information carefully before installing and operating your cordless telephone.

Unpacking

Check to make sure you have all the items that come with the telephone.

Handset with rechargeable battery



Telephone cord with 4-prong jack

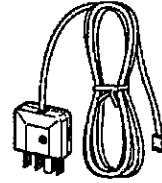

Base station

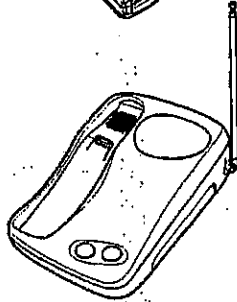

Speed dial directory sheet



AC adaptor

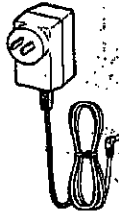

Wall mount bracket



DESCRIPTION

Cordless telephones operate on the same principle as a two-way radio. The location of the base station determines the range of operation. In most homes, maximum range is obtained by locating the base station at the highest point in the house.

The base station operates from a 240 volt AC electrical outlet. Connect the base station to a telephone line by simply plugging it into a standard telephone jack. The handset is powered by a heavy-duty rechargeable battery.

CAUTION

Charge the handset before using the cordless phone for the first time. Do not attempt to use the phone before charging the battery pack for a full 10 hours.

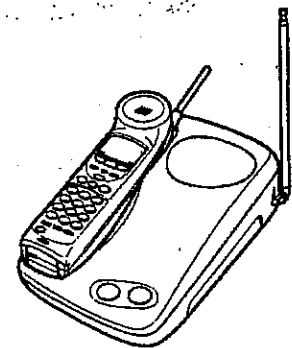

Names of controls

BASE STATION

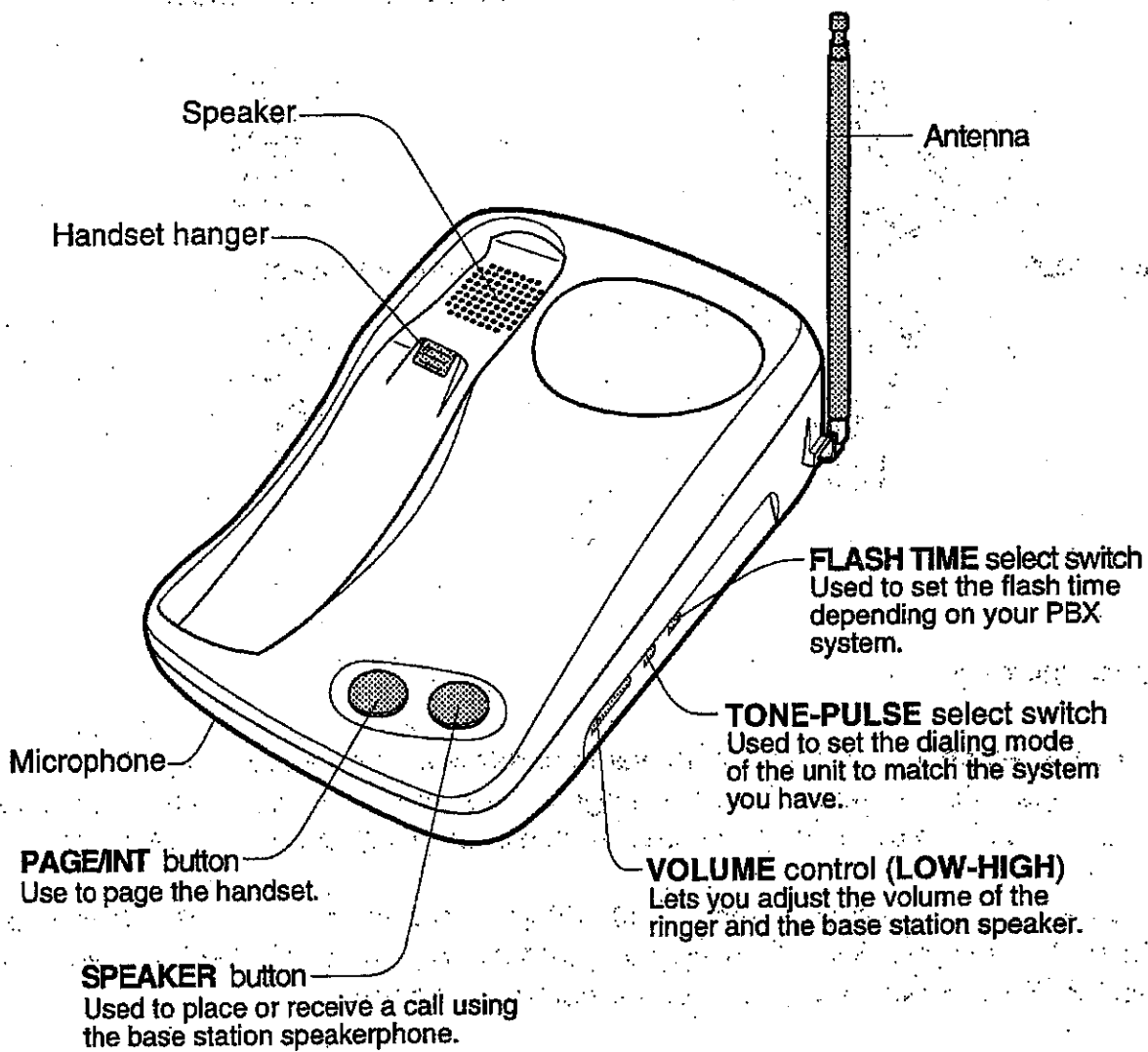

Names of controls

BASE STATION

TEL indicator

Flashes when a call is coming in, the handset is paging or a call is on hold.
Lights when the base station is in use.

INTERCOM indicator
Lights when the intercom feature is being used.

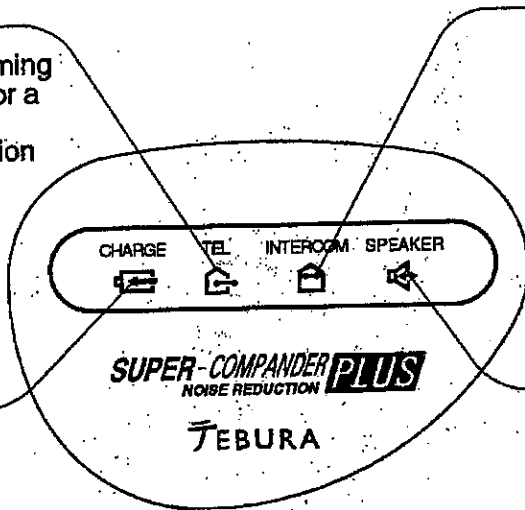

CHARGE indicator
Lights when the handset is being charged.

SPEAKER indicator
Lights when the base station speakerphone is in use.

Names of controls

HANDSET

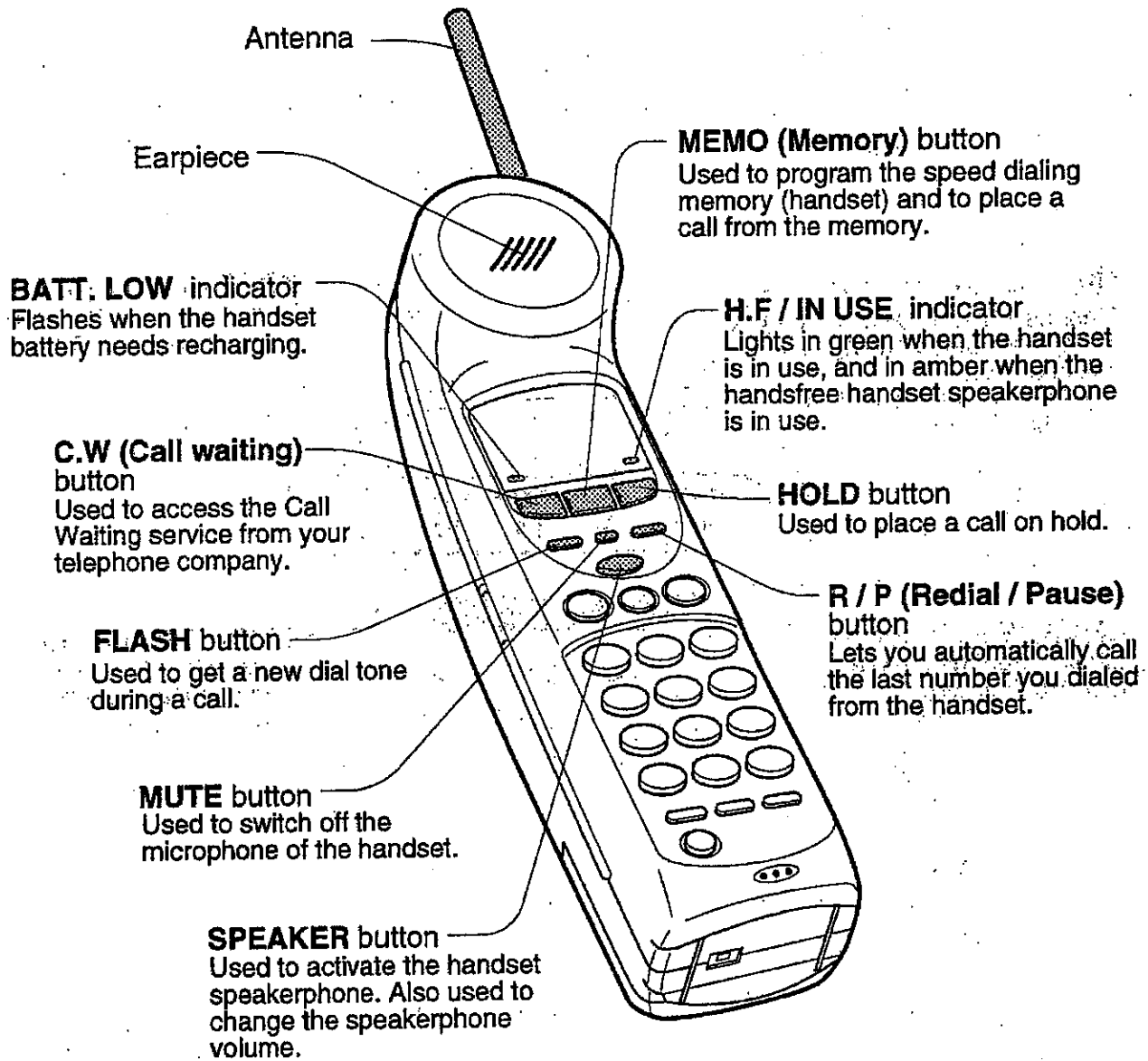

Names of controls

HANDSET

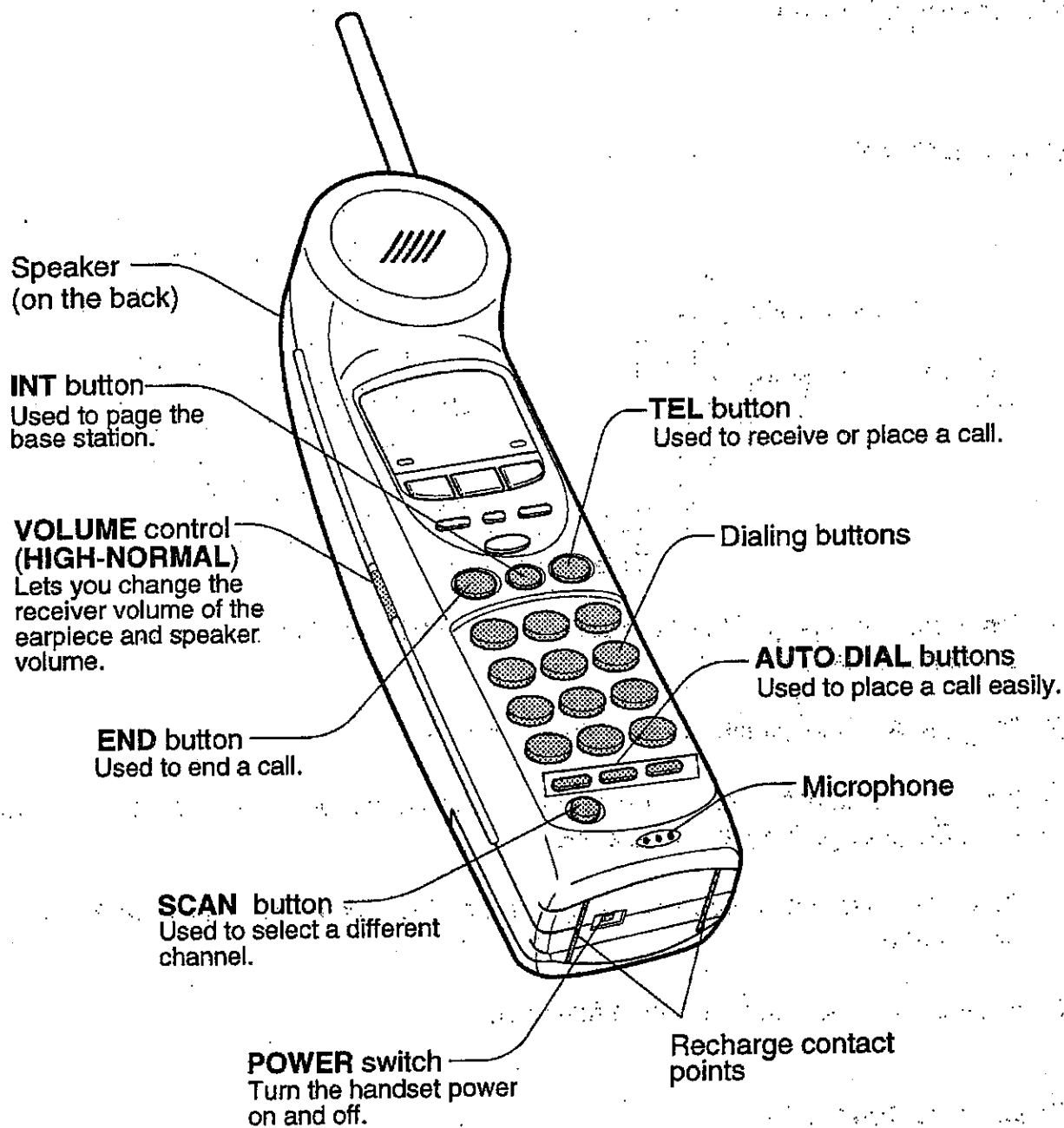

Installation

LOCATION

Avoid places near electrical equipment such as refrigerators, computers, TVs or fluorescent lamps. These may cause interference or reduce the operating range of the cordless telephone.

CONNECTIONS

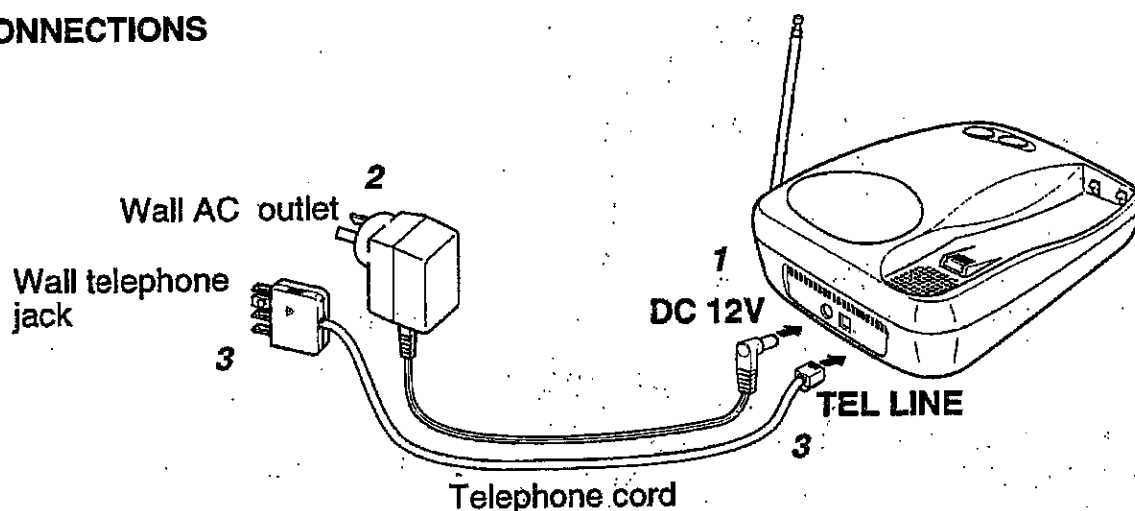

- 1** Insert the small plug of the AC adaptor into the **DC 12V** jack provided on the back of the base station.
- 2** Plug the AC adaptor into an AC 240V wall outlet.
- 3** Insert one plug of the telephone cord into a wall telephone jack and the other into the **TEL LINE** jack on the base station.
- 4** Store the telephone cord by winding it around the cord holder on the back of the base station.
- 5** Extend the base station antenna full-length.

Direct Wire Connection

If your current phone is wired directly into the wall, have the phone company install a wall phone jack.

Party Line or Pay Phone

If you have a party line or a pay phone, telephone companies do not allow the installation of cordless telephones, because they will not work correctly with these systems.

Installation

DIALING SYSTEM

Set the **TONE-PULSE** switch on the base station to the dialing system used in your home (touch-tone or pulse). If you do not know which system is in use, ask your telephone company.

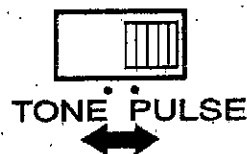

Charging the handset battery

IMPORTANT

Charge the handset before using the cordless phone for the first time.
Do not attempt to use the handset before charging it for a full 10 hours.

- 1 Place the handset on the base station and charge it for 10 hours.

Bidirectional handset

The handset can be placed with the keypad facing up or down.

- 2 Remove the handset from the base station.

- 3 Set the **POWER** switch to **ON**.

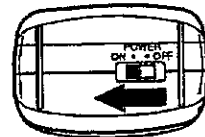

The **BATT. LOW** indicator will flash when the handset needs recharging. Simply place the handset in the base station cradle and charge it for 10 hours. It is not necessary to turn the **POWER** switch off after initial charging.

Note

- The handset battery can be recharged and reused many times.
- Repeated recharging for a shorter period may reduce the battery time.
- If the handset battery fails (the **BATT. LOW** indicator flashes) even after being charged for 10 hours, replace it with a new Sanyo cordless telephone battery, type **3N-270AA** (See page 22).

Placing a call

USING THE HANDSET

Make sure the handset **POWER** switch is **ON**.

- 1 Listen for a dial tone by lifting the handset from the base station, or by pressing **TEL**.
The green **H.F. / IN USE** indicator lights.

- 2 Dial the number.

- 3 Press **END** to hang up.
(or return the handset to the base station.)

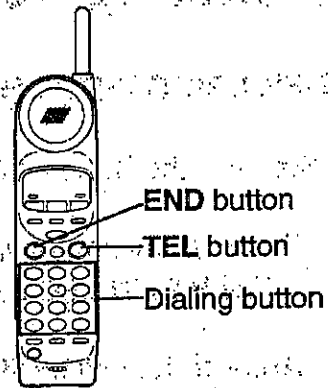

To adjust the volume

Use the **VOLUME** control (**HIGH-NORMAL**) on the side of the handset.

OUT-OF-RANGE ALARM

A warning beep sounds if you take the handset too far away from the base station while it is in use. You must return to operating area within 30 seconds to prevent the telephone from hanging up automatically.

MULTICHANNEL ACCESS

This cordless telephone lets you select a channel from 5 frequencies available to transmit signals between the base station and handset. If you notice interference during a call, simply select a different channel by pressing the **SCAN** button on the handset.

Answering a call

ANSWERING WITH THE HANDSET

Make sure the handset **POWER** switch is **ON**.

- 1** When a call comes in, the handset rings.
The **H.F / IN USE** indicator and the dialing keypad flash.
- 2** Answer the call by lifting the handset from the base station, or by pressing **TEL** or any button.
- 3** Press **END** to hang up, or place the handset in the base station cradle.

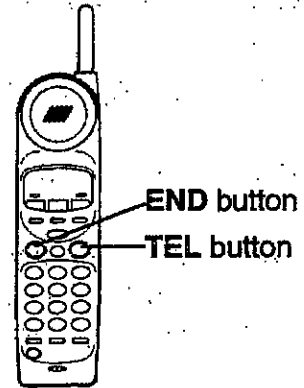

Dial light

The dialing keypad of the handset flashes when an incoming call is ringing, and lights up for 10 seconds when **TEL** is pressed or the handset is lifted from the base station. Press a dialing button any time to light it up again for 10 seconds.

Using the speakerphones

The CLT 9650 has two speakerphones--one on the handset and the other on the base station--which allow you to answer, and also place a call on the handset. Both speakerphones let you have a handsfree phone conversation--no need to hold the handset.

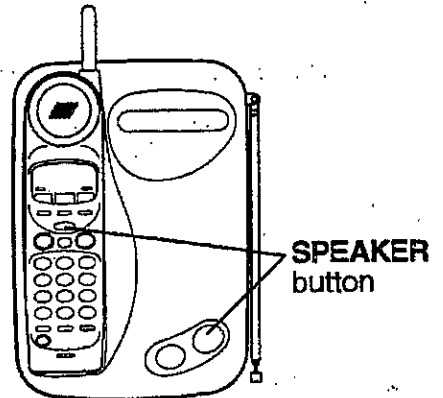

To place a call using the handset speakerphone:

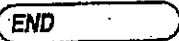
- 1 Press  and listen for a dial tone.
The amber H.F / IN USE indicator lights.
- 2 Dial the number.
- 3 Press  to hang up.

HANDSET

To answer a call using the handset speakerphone:

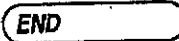

- 1 Press .
The amber H.F / IN USE indicator lights.
- 2 Press  to hang up.

To adjust the speaker volume:

Use the **VOLUME control (HIGH-NORMAL)** on the side of the handset.

BASE STATION

To answer a call at the base station:

- 1 Press  to answer a call.
The **SPEAKER** indicator lights.
- 2 Press  again to hang up.

To adjust the speaker volume:

Adjust the **VOLUME control** left (low) or right (louder). This will also change the ringer volume level.

CAUTION

When using the handsfree handset speakerphone, keep the speaker (located on the back of the handset) away from your ear to prevent any damage to your ear.

Hold

When a call is on hold, you and your caller can not hear each other.

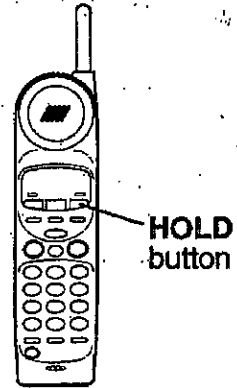

1 Press **HOLD** to place a call on hold.
The **H.F / IN USE** indicator flashes.

2 Press **HOLD** again or **TEL** to return to the call.

While a call is on hold, notifying tone (a short beep) will be heard every 5 seconds from handset or the base station. If a call is on hold for more than 5 minutes, the telephone automatically disconnects from the line.

You can replace the handset on the base station while a call is on hold. To return to the call, press **TEL** or **SPEAKER** on the handset or **SPEAKER** on the base station, or simply lift the handset.

Mute

The **MUTE** button switches off the microphone of the handset. You can hear your caller, but your caller can't hear you.

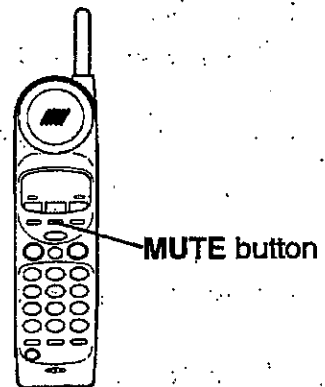

1 Press and hold **MUTE** to mute the microphone.

2 Release **MUTE** to return to the call.

Redial

You can automatically redial the last number called
(after getting a busy signal, for example.)
This CLT 9650 can redial a number of up to 32 digits.



REDIAL/P
button

1 Press **TEL** to get a new dial tone.

2 Press **R/P**.
The last number called from the handset is automatically dialed out.

Auto dial

If you store the regularly call numbers, you can call that number only pressing the button (AUTO 1 - 3). Stored phone numbers can have a maximum of 32 digits including pauses.

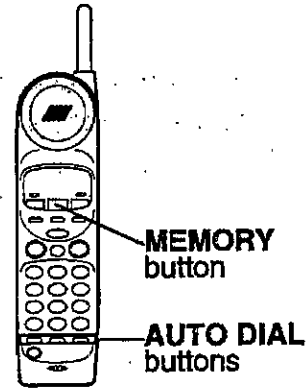

To store a number:

(Make sure the handset is in standby mode).

- 1 Press **MEMO**.
- 2 Dial the number you want to store.
- 3 Press **MEMO**.
- 4 Press an AUTO button (1 - 3).
You hear a beep. The number is now stored.

Note

To insert a 4-second pause between two digits in a stored number (after 9 or 0 to get an outside line in a PBX system, for example), press **R/P** after the first digit.

To call a number stored in the memory

- 1 Pick up the handset from the base station or press **TEL**.
- 2 Press an AUTO button (1 - 3).
The number is dialed out automatically.

Speed dial

The speed dial memory can store up to 10 numbers (0 - 9) in the handset. Stored phone numbers can have a maximum of 32 digits including pauses.

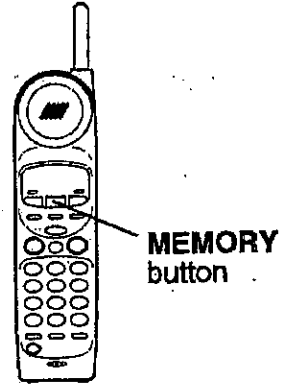

To store a number:

(Make sure the handset is in standby mode).

- 1 Press **MEMO**.
- 2 Dial the number you want to store.
- 3 Press **MEMO**.
- 4 Press a number button to assign a location number (0 - 9).
You hear a beep.
The number is now stored.

Note

To insert a 4-second pause between two digits in a stored number (after 9 or 0 to get an outside line in a PBX system, for example), press **R/P** after the first digit.

Speed dial

To call a number stored in the memory

1 Press **TEL**.

2 Press **MEMO**.

3 Press the location number (0 - 9) assigned in the handset.
The number is dialed out automatically.

To delete a number from the handset speed dial memory:

1 Press **MEMO**.

2 Press **MEMO** again.

3 Enter the location number (0 - 9).
You hear a beep.
The number is now erased.

Intercom

You can use the CLT-9650 as a 2-way intercom between the handset and the base station.

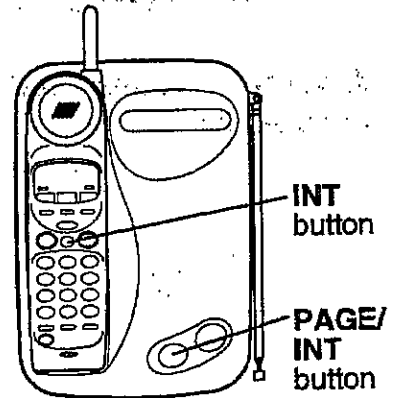

FROM BASE STATION TO HANDSET

1 Base station:
Press **PAGE/INT** to page handset.
The **INTERCOM** indicator flashes.

2 Handset:
Press **INT** and begin talking.
The **H.F / IN USE** indicator lights.

3 Handset:
Press **END** to turn off intercom.

If the handset does not answer within 5 minutes, the base station automatically returns to the standby mode.

FROM HANDSET TO BASE STATION

1 Handset:
Press **INT** to page the base station.
The **H.F / IN USE** indicator flashes.

2 Base station:
A beep sound, and the **INTERCOM** indicator lights.
The base station user can begin talking.

3 Handset:
Press **END** to turn off intercom.

Note

Handset user cannot use speakerphone for intercom conversation.

Transferring a call

A call can be transferred between the handset and the base station.

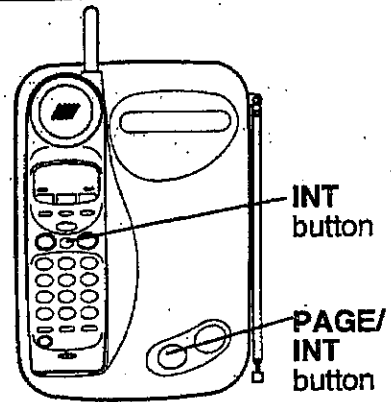

FROM BASE STATION TO HANDSET

1 Base station:

Press **PAGE/INT** to alert the handset user.
The call is put on hold.
The **TEL** and **INTERCOM** indicators flash.

2 Handset:

Press **INT** to answer the base station.
The **H.F / IN USE** indicator lights.

3 Handset:

Press **TEL** to talk to the caller.
Base station automatically switches to standby mode.

If the handset does not answer, press **SPEAKER** to talk to the caller again.

FROM HANDSET TO BASE STATION

1 Handset:

Press **INT** to page the base station.
The call is put on hold.

2 Base station:

A beep sounds, and the **TEL** indicator flashes. The **INTERCOM** indicator lights.
The base station user can answer the handset.

3 Base station:

Press **SPEAKER** to talk to the caller.

Handset automatically turns off intercom mode.

If the base station does not answer, press **TEL** to talk to the caller again.

Flash button

The **FLASH** button may be used to get a new dial tone without pressing the **END** button or replacing the handset in the base station cradle.

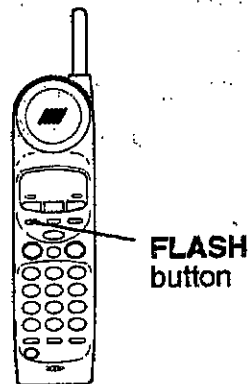

FLASH TIME

Set the **FLASH TIME** switch on the base station depending on your PBX system (100msc, 350msc or 600msc).

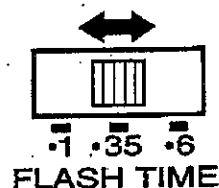

Temporary tone-dialing

If your home is equipped with pulse dialing and your phone is set to pulse mode, you may still change to Touch-Tone dialing temporarily. This allows you to access special services available to Touch-Tone lines (electronic banking systems and remote-control answering machines, for example).

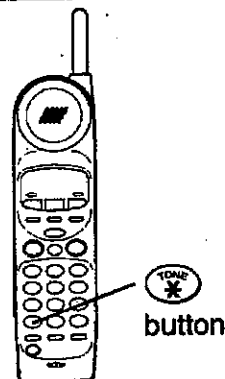

- 1 Dial the number you want to call.
- 2 When your call is connected, press the **TONE**  button.

The telephone stays in tone mode until the call ends. Then it returns automatically to pulse mode.

Call Waiting button

Call Waiting service must be subscribed from your telephone company or PBX system.

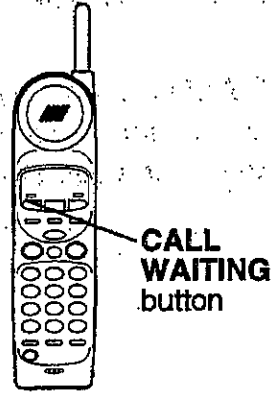

If you subscribe to Call Waiting...

1 When a call comes in while you are on the phone, you hear a soft beep.

2 Press **C.W**.

The first caller is put on hold and you can answer the second caller.

3 Press **C.W** again to talk to the first caller.

The second caller is now put on hold.

Replacing the handset battery

- 1 Set the **POWER** switch of the handset to **OFF**.
- 2 Slide the lid off the battery compartment.
- 3 Unplug the battery cord, and remove the old battery.
- 4 Plug in the cord of the new battery and place it in the compartment.
- 5 Replace the lid by sliding it up over the pack until it is firmly in place.
- 6 Set the **POWER** switch back to **ON**.
- 7 Charge the new battery for 10 hours before use.

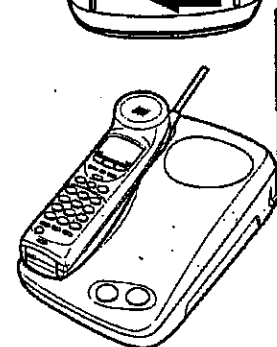
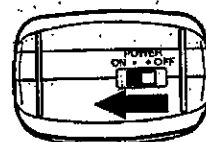
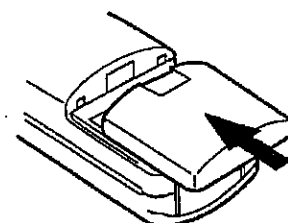
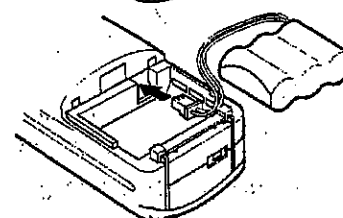
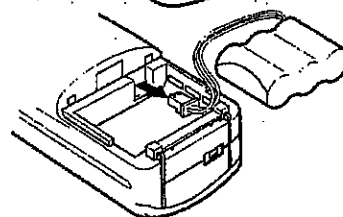
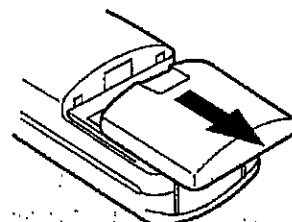
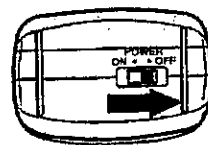

Replacement battery part number: **SANYO 3N-270AA**

CAUTION

Use of wrong battery types may cause serious damage or malfunctions.
The warranty could be invalidated.

Wall mounting

To mount the base station on a wall:

- 1 Remove the handset hanger from the base station, turn it upside down and then reattach it.

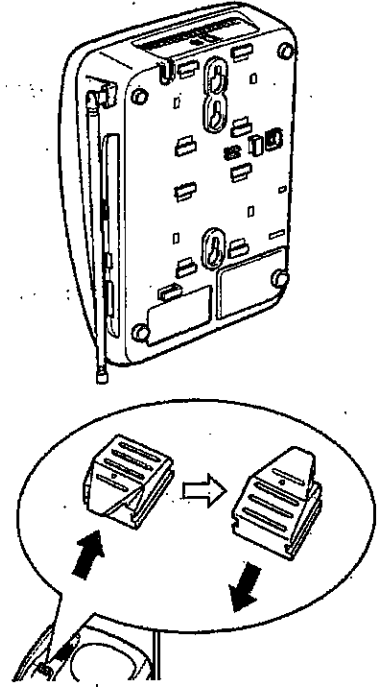

- 2 Insert the hooks of the wall mount bracket into the holes in the back of the base station. Then push them in the direction of arrow as shown.

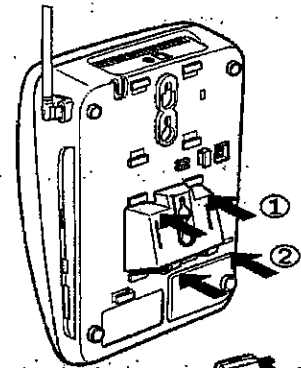

- 3 Connect the cord to a wall phone plate (not supplied). Mount the base station on the wall phone plate and seat it securely.

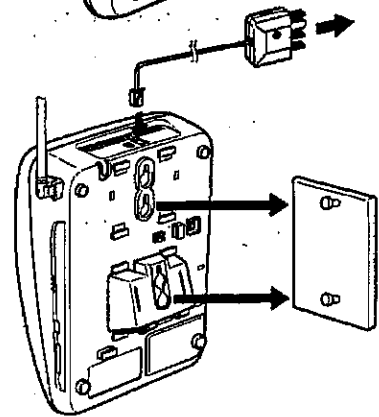

- 4 Hang the handset on the base station with keypad facing front.

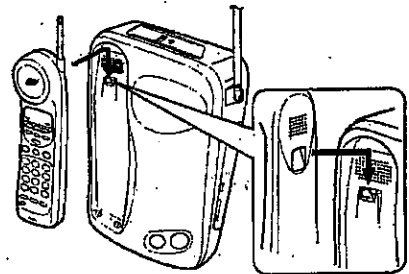

Troubleshooting

The phone does not work:

- AC adaptor may not be plugged into wall outlet.
- Handset battery may need recharging.
- Handset may be too far from base station.

The communication range becomes shorter:

- Handset may need recharging.
- Base station antenna may not be extended to full length.

Incoming calls do not ring on the handset:

- Handset may be too far from base station.
- Handset **POWER** switch may be set to **OFF**.

If the phone still does not work, try resetting the base station and handset:

To reset base station

- Disconnect and reconnect the AC adaptor.

To reset handset

- Set the **POWER** switch to **OFF** and then back to **ON**.
- Disconnect and then reconnect the handset battery.

Security code

The security code system prevents other cordless phone users in your neighbourhood from interfering with the operation of your unit, by assigning a same code to both handset and base station. Since the security code of this telephone was selected from 1,000,000 different codes, it is virtually impossible to find any other cordless telephone having the same code as yours. However, if you wish to set your own security code, follow the steps below.

- 1** Disconnect the AC adaptor.

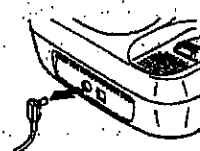

- 2** Set the **POWER** switch of the handset to the **OFF** position.

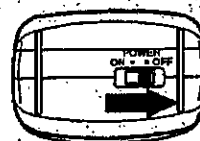

- 3** Press and hold **PAGE / INT** on the base station and reconnect the AC adaptor. Release **PAGE / INT**.

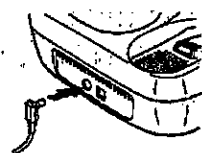

- 4** While pressing **END** on the handset, set the **POWER** switch to **ON**. Release **END**.

- 5** Enter the desired 6-digit number (000,000 - 999,999) using the dialing buttons on the handset.

- 6** Press **TEL** on the handset.

You hear long beeps from both handset and base station.
Your personal security code is now set.

Steps **4 - 6** must be performed within 20 seconds.

If not, five short beeps sound to indicate that you should start again from step **1**.

Technical Information

Cordless telephones use radio frequencies to allow mobility. This affects the performance of your unit.

1.NOISE

Electrical pulse noise is present in most homes at one time or another. This is most intense during electrical storms. Certain kinds of electrical equipment, such as light dimmers, fluorescent bulbs, motors, fans, etc., also generate pulse noise.

Because radio frequencies are susceptible to this, you may on occasion hear pulse noise through the handset. This is usually only a minor annoyance and should not be interpreted as a defect of the unit.

2.RANGE

Because radio frequencies are used, the location of the base station can affect the operating range of the unit. Try several locations and choose the one that gives the clearest signal to the handset. (Turning in a circle while holding the handset may also increase the operating range.)

3.INTERFERENCE

Electronic circuits activate a relay to connect the unit to your telephone line. These electronic circuits operate in the radio frequency spectrum. While several protection circuits are used to prevent unwanted signals, there may be periods when these unwanted signals enter the base station. You may hear click or hear the relay activate when you are not using the cordless handset. If this occurs frequently, you can minimize or eliminate the problem by lowering the height of the base station or relocating the base station. It may also be helpful to change the operating channel and/or the security code setting.