

SANYO

INSTRUCTION MANUAL

Colour Television

CP14SR1Z

CA14SR1Z

CA14SA1

CP20SR1Z

CA20SR1Z

CA21SA1

***CATV Hyper
Video Status
Plug & Play***

100 Programmes with Automatic Tuning

Contents

Plug & Play	3
Aerial Connection	3
Front Controls	4
Warnings and Cautions	5
Remote Control Transmitter	6
Battery Installation of the Remote Control Transmitter	... 6
General Operation	
Power ON/OFF	7
Auto Shut Off Function	7
Direct Programme Selection	7
Programme UP and Down	7
Channel Scanning	7
Volume Control	8
Recall	8
Sound Mute	8
Alternate	8
Quick Picture Controls	8
Off Timer	9
On Timer	9
Picture Adjustment	10
Tuning of the Channels	
Automatic Tuning	11
Semi-auto Tuning and Manual Tuning ..	12
Channel Copy	13
Channel Swapping	13
Skip Channel Set and Cancel	... 14
Setting of the Private Position	15
Connecting other Equipment	
Connecting to the AV Input Jacks	16
Selecting the Colour System in AV mode	... 17
Connecting to the Monitor Output Jacks	... 17
AV Connection to the Aerial Socket	17
Helpful Hints-Problems/Solutions ..	18
Specifications	19

Plug & Play

Automatic setting up channels

This TV set provides a self-automatic tuning and sorting system function called "**Plug & Play**". It automatically begins searching and storing of all available channels when switching-on the TV set for the first time.

Let's start !

- 1 Connect power cord of the TV set to a wall outlet, and turn on the TV set by pressing the **Mains ON/OFF** button. Self-automatic tuning system will be started as follows;

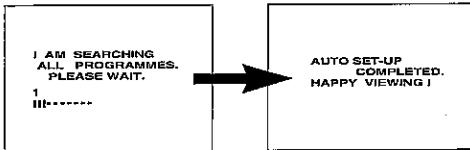

After completing this procedure, the programme position 1 is selected and the ending messages on the screen.

Note: The Plug & Play can be cancelled at any time by pressing the **MENU** button.

- 2 Press any of the control buttons to make the ending message disappear. (Or will automatically return to normal TV display after 10 seconds.)

- ☞ This procedure only appears at the first switch-on time.
- If no TV stations are found, the display shown below will appear. Please check if the antenna is connected properly.



If it isn't connected properly, connect antenna and Automatic Tuning will be reset.

Aerial Connection

Connecting Outdoor Aerial

Connect the cable with a plug from a UHF (or VHF) aerial to the aerial socket on the cabinet back.

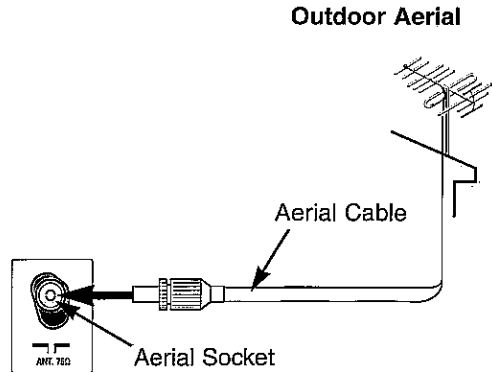

For all aerial circuit problems please consult your local dealer.

Mounting Telescopic Aerial

(except for CA20SR1Z and CA21SA1 model)

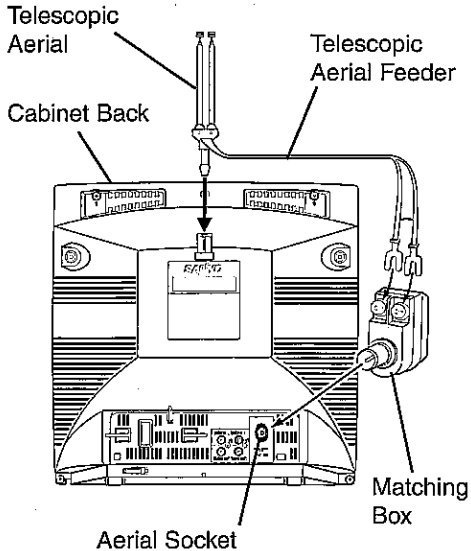

Front Controls

Each button listed in this section has the same function as its corresponding button on the remote control.

Model CP14SR1Z / CA14SR1Z

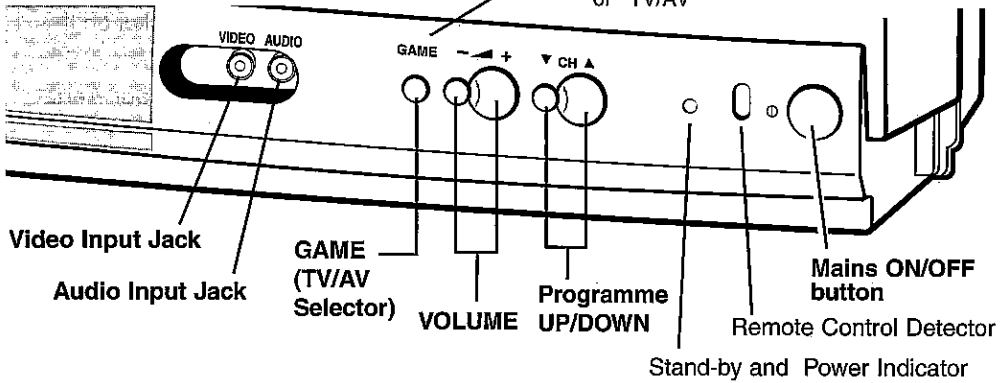

Model CP20SR1Z / CA20SR1Z

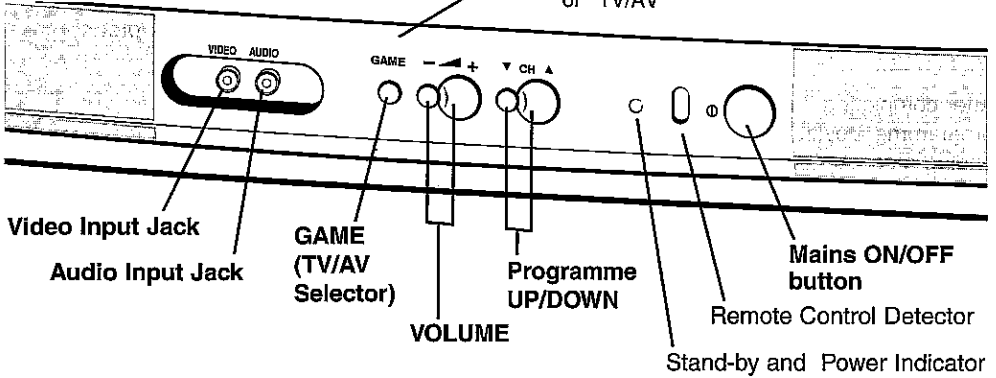

Model CA14SA1 / CA21SA1

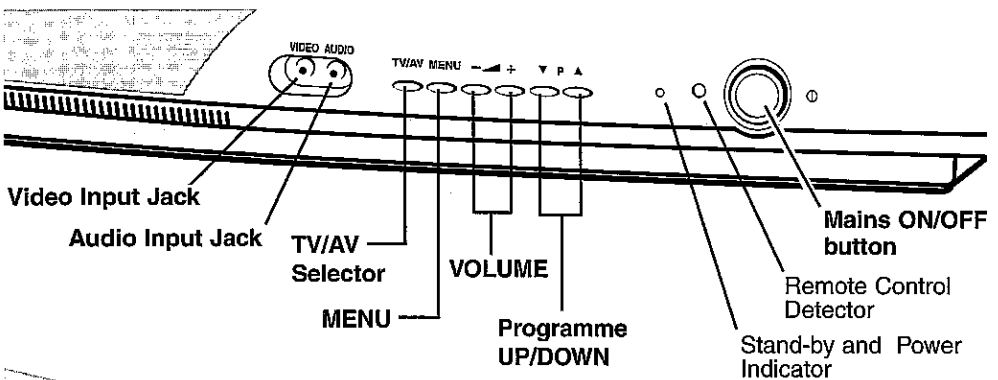

Warnings and Cautions

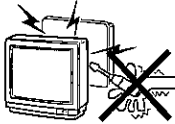

Warning

High voltages are used in the operation of this television receiver. Do not remove the cabinet back from your set. Refer servicing to qualified service personnel.

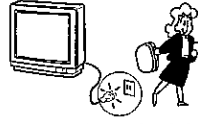

Caution

When the television receiver is not used for an extended period of time, it is advisable to disconnect the AC power cord from the AC outlet.



Warning

Do not drop or push objects into the television cabinet slots or openings. Never spill any kind of liquid on the television receiver.

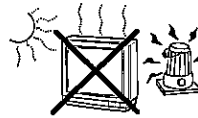

Caution

Avoid exposing the television receiver to direct sunlight and other source of the heat. Do not stand the television receiver directly on other products which give off heat. E.g. video cassette players, audio amplifiers.

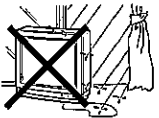

Warning

To prevent fire or electrical shock hazard, do not expose the television receiver to rain or moisture.

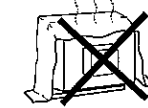

Caution

Do not block the ventilation holes in the back cover. Adequate ventilation is essential to prevent failure of electrical components.



Caution

Never stand on, lean on or push suddenly the television or its stand. You should pay special attention to children. Serious injury may result if it should fall.

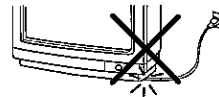

Caution

Do not squash power supply cord under the television receiver.

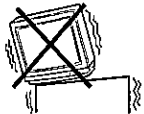

Caution

Do not place your television on an unstable cart, stand, shelf or table. Serious injury to an individual, and damage to the television, may result if it should fall.

Minimum distances

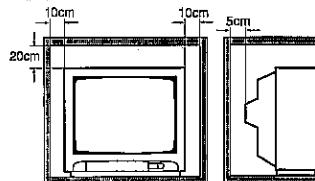

Caution

If the television is to be built into a compartment or similarly enclosed, the minimum distances must be maintained. Heat build-up can reduce the service life of your television, and can also be dangerous.

Remote Control Transmitter

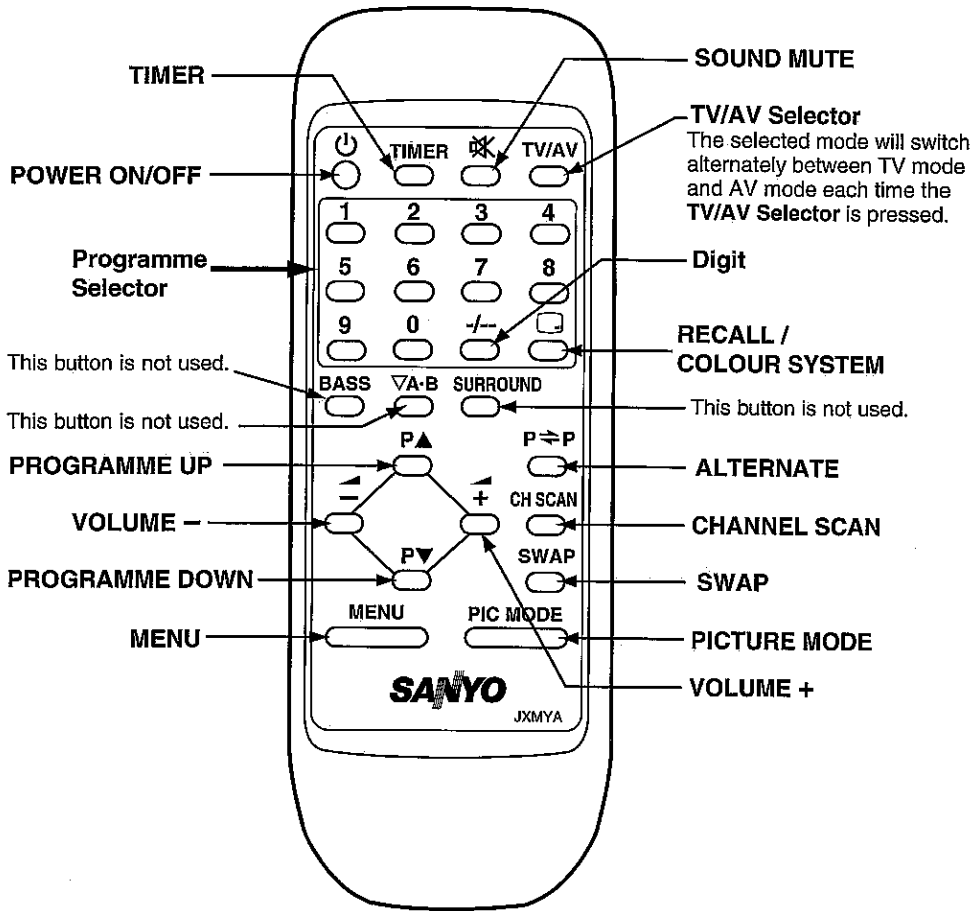

Battery installation of the Remote Control Transmitter

1. Open the battery cover.
2. Install two "AA" 1.5 volt batteries so that the "+" and "-" marks on the batteries match the "+" and "-" marks inside the unit.
3. Close the battery cover.

Note: Replace the batteries when the TV set is showing the following symptoms:
 Operation is unsteady or erratic, sometimes the TV set does not work with transmitter.
 Discharged batteries may leak and damage the unit. The normal life of batteries should be from nine to ten months.

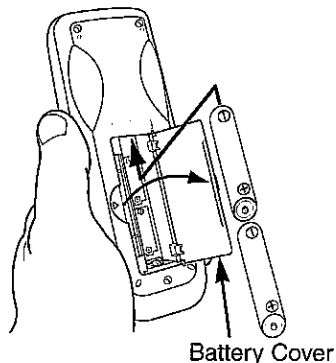

Battery Cover

General Operation

Power ON/OFF

To switch on or off the TV ;
Press the **Mains ON/OFF** button.
The power of the TV is turned on or off completely. If no picture appears but the Standby and Power indicator illuminates, press the **Power ON/OFF** button of the remote control transmitter as the TV set is in standby mode.

To set the TV to standby mode;

Press the **Power ON/OFF** button.
During Standby mode the Standby and Power indicator illuminates more brightly.

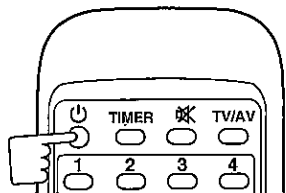

To turn on the TV from the standby mode, press any of the following button.

- **Power ON/OFF** button of the remote control transmitter.
- **Programme UP/DOWN** of the remote control transmitter or the TV set.
- **1 to 9, 0** button on the remote control transmitter.

Important !

Be sure to set the **Mains ON/OFF** switch to the off position, if the power failure occurs while viewing.

Auto Shut Off Function

This TV set incorporates the **AUTO SHUT OFF** function. Even if the TV is left on after you have gone to sleep, the TV set changes to the standby mode within 10 minutes after all broadcasts have ended.

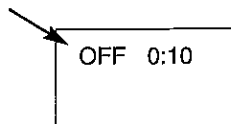

Direct Programme Selection

Example

To select programme position 8;

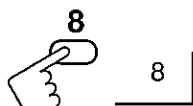

Press "8" button.

To select programme position 10;

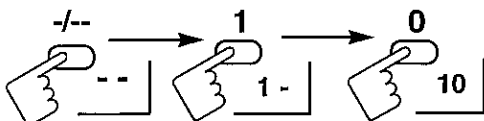

Press the **Digit** button. Press "1" button. Press "0" button.

To select programme position 27;

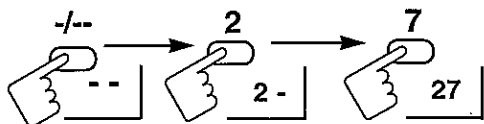

Press the **Digit** button. Press "2" button. Press "7" button.

Programme Up and Down

Press the **Programme UP** (P▲) button to select the next programme position.
Press the **Programme DOWN** (P▼) button to select the previous programme position.

Channel Scanning

Press the **CHANNEL SCAN** button to search for a programme. The channel positions are automatically scanned, and the channel scanning will stop at the position where it began. To stop at the position you want, press this button again.

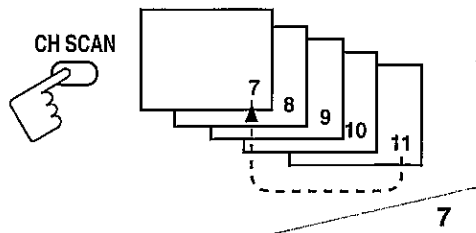

General Operation

Volume Control

Increase or decrease the sound volume level by pressing the **VOLUME (+ or -)** buttons.

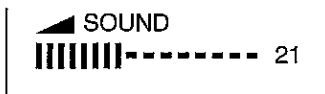

RECALL

To display the on screen indications, press the **RECALL/COLOUR SYSTEM** button.

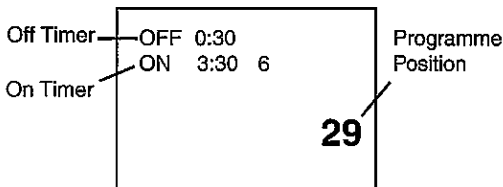

Screen display disappears after about 5 seconds.

Sound Mute

Should you wish to mute the sound (e.g. While talking on the telephone), press the **SOUND MUTE** button.

To switch the sound back on, press the **SOUND MUTE** button again.

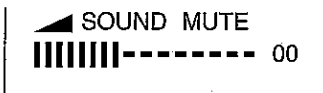

ALTERNATE

Press the **ALTERNATE** button, and the programme position will alternately select the previous position and the present position.

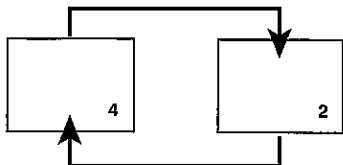

Quick Picture Controls

Press the **PICTURE MODE** button to select the following picture modes; "**PERSONAL**", "**DYNAMIC**", "**NATURAL**", "**ECO**" and "**GAME**". Select picture modes to suit picture type you are watching.

Each time the **PICTURE MODE** button is pressed, picture settings changes as follows;

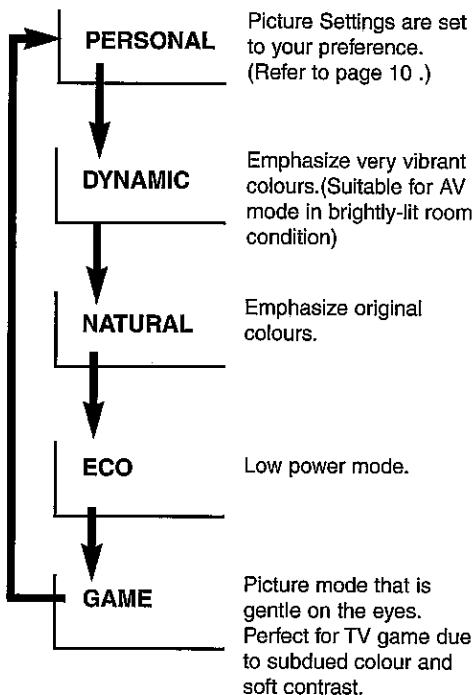

General Operation

OFF TIMER

The OFF TIMER will switch off the TV automatically after 30 minutes, 1 hour, 1 hour and 30 minutes, or 2 hours.

1 Press the **TIMER** button.

OFF 0:00 (OFF TIMER setting mode)

Each time the **TIMER** button is pressed, timer function is changed as follows;

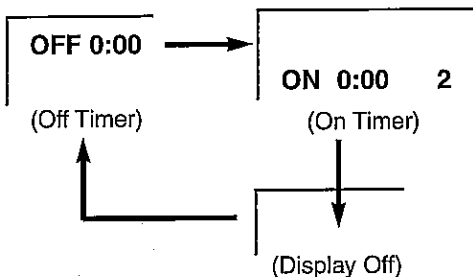

2 Press the **VOLUME (+ or -)** button to select the time period.

- Just one minute before switching off the TV, "OFF 0:01" will be display on the screen.
- To cancel the OFF TIMER, select "OFF 0:00" by pressing the **VOLUME (+ or -)** button.
- The OFF TIMER cancels when the TV set is turned off or if a power failure occurs.

ON TIMER

When the ON TIMER is set, TV will automatically be switched on to the selected programme position when the specified time has elapsed.

1 Press the **TIMER** button twice.

ON 0:00 2 (ON TIMER setting mode)

Programme position for when TV is switched on by ON TIMER.

2 Press the **VOLUME (+ or -)** button. The set time will be increased or decreased by 10 minutes each time the button is pressed ; the maximum time which can be set is 24 hours. When the ON-TIMER has been set, the colour of Standby and Power Indicator changes to yellow.

Setting programme position for when TV is switched on by ON TIMER

To set programme position to between 0 and 9, press the desired number button "0" - "9" while the ON TIMER screen is shown.

ON 3:30 9

For example, to set programme position 26, press the **Digit** button, "2" button then "6" button while the ON TIMER screen is shown.

ON 3:30 26

It is also possible to set the programme position by pressing the **PROGRAMME UP** or **DOWN** button.

To set an AV position for when the TV is switched on by the ON TIMER, press the **TV/AV Selector** while the ON TIMER screen is shown to select position AV.

ON 3:30 2 → ON 3:30 AV

- If no operation is performed after the TV has been switched on by the ON TIMER, such as if you are not at home, the TV will be automatically switched off after approximately 2 hours.
- If the TV is already switched on when the time set for the ON TIMER has been reached, only the programme position will be changed to the set programme position.
- **Canceling ON TIMER**
To cancel the ON TIMER, either press the **VOLUME (+ or -)** button to set it to "ON 0:00" while the ON TIMER screen is shown. Switching off the TV by pressing the **Mains ON/OFF** button will also cancel the ON TIMER settings.

Picture Adjustment

Picture Adjustment Menu

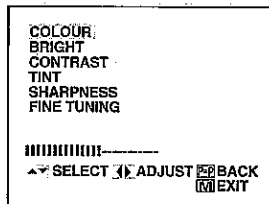

Picture Adjustment Item

COLOUR : Adjusts colour intensity.

BRIGHT : Adjusts picture brightness.

CONTRAST : Adjusts picture contrast.

TINT : Adjust colour tints. (Displayed only on NTSC or NTSC4.43 system signal reception.)

SHARPNESS : Adjusts picture detail.

FINE TUNING :

Fine tuning in case of weak broadcast signal or poor reception. Only displayed in TV mode. Will not be displayed in AV mode.

Note:

The picture adjustment data (Colour, Brightness, Contrast, Tint and Sharpness) is automatically stored in PERSONAL mode of the Quick Picture Controls (See page 8). These settings will be used when PERSONAL mode is selected.

PERSONAL

Basic picture adjustment operation

- 1 Press the **MENU** button for MAIN menu display.

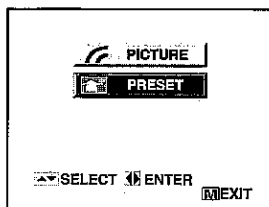

(MAIN MENU)

- 2 When "PICTURE" is not selected, select "PICTURE" with the **Programme UP** or **DOWN** button.

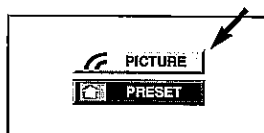

- 3 Press the **VOLUME +** or **-** button to display Picture Adjustment menu.

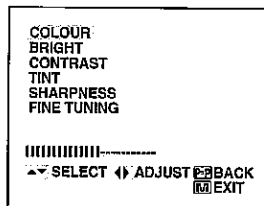

- To return to Main menu, press the **ALTERNATE** button.
- To return to the normal TV mode, press the **MENU** button. (Or will automatically return to the normal TV mode after 20 seconds.)

- 4 Select desired control by pressing the **Programme UP** or **DOWN** button.

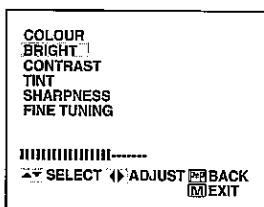

- 5 Press the **VOLUME +** or **-** button to alter settings.



Approximately five seconds after you release the **VOLUME (+ / -)** button, the screen display switches from the adjustment screen to the normal TV screen. To return to the Picture adjustment menu, press the **ALTERNATE** button within five seconds of releasing the **VOLUME (+ / -)** button.

Tuning of the Channels

Up to 100 broadcast stations in your reception area can be stored in the electronic memory.

There are three ways of tuning as follows;

1. Automatic Tuning (the basic way):

All receivable channels are automatically tuned in and memorized in consecutive programme position.

2. Semi-Auto Tuning:

Use to preset a receivable channel in any desired programme position, e.g. the position with the same number as the channel.

3. Manual Tuning:

Manually tune a channel if it cannot be automatically tuned, such as when the signal is poor.

Automatic Tuning

- 1** Press the **MENU** button for MAIN menu display.

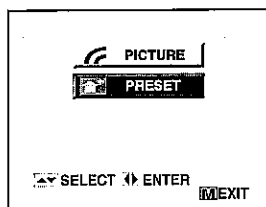

(MAIN MENU)

- 2** Select "PRESET" by pressing the **Programme UP** or **DOWN** button.



- 3** Press the **VOLUME +** or **-** button for PRESET menu display. On entering PRESET display, Automatic Tuning will be selected initially.

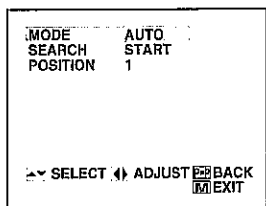

- 4** Select "SEARCH" by pressing the **Programme UP** or **DOWN** button.

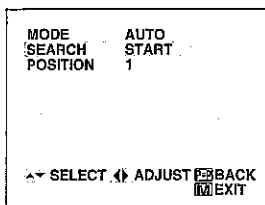

- 5** Press the **VOLUME (+)** button to start channel tuning.

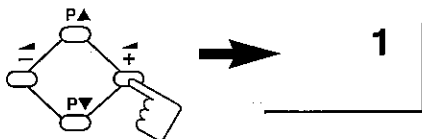

After all receivable channels have been found and stored, the TV set automatically returns to programme position "1".

- The Automatic Tuning operation can be cancelled at any time by pressing the **Programme UP** or **DOWN** button.

Tuning of the Channels

Semi-Auto Tuning and Manual Tuning

- 1 Press the **MENU** button for MAIN menu display.
- 2 Select "PRESET" by pressing the **Programme UP** or **DOWN** button.

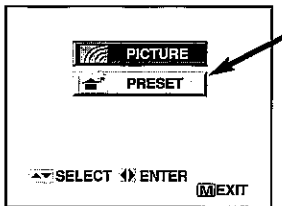

- 3 Press the **VOLUME +** or **-** button for PRESET menu display. On entering PRESET display, Automatic Tuning will be selected initially.
- 4 Select "SEMI" or "MANUAL" by pressing the **VOLUME +** or **-** button.

Semi-Auto Tuning Mode

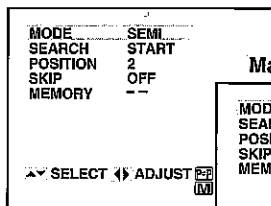

Manual Tuning Mode

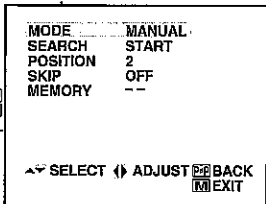

- 5 For example, to pre-set a required channel onto Programme Position 6, select "POSITION" with the **Programme UP** or **DOWN** button and press remote control button number **6** and enter 6. (In this case, the channel being watched will change to channel 6.)

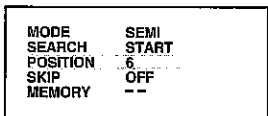

For example, to enter Programme Position 27, press the **Digit** button, press the remote control button **2** followed by **7**.

It is also possible to select the Programme position number by pressing either of the **VOLUME +** or **-** button. (Pressing the **VOLUME +** or **-** button will only alter the programme position number.)

- 6 Select "SEARCH" by pressing the **Programme UP** or **DOWN** button.

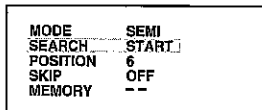

Semi-Auto Tuning:

Press and release the **VOLUME +** or **-** button to search for required TV station. Once a station is located, tuning will automatically stop. Continue till desired channel is located.

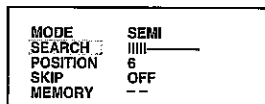

Manual Tuning :

Press and hold the **VOLUME +** or **-** button to search for required TV station.

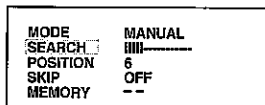

The **VOLUME +** button will move tuning toward the higher frequencies, and the **VOLUME -** button will move tuning toward the lower frequencies.

- 7 Once desired channel is located, select "MEMORY" by pressing the **Programme UP** or **DOWN** button.
- 8 Press the **VOLUME +** or **-** button to enter the desired channel into Programme Position 6.

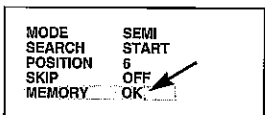

To pre-set other Programme Positions, repeat steps 5-8.

- 9 Press the **MENU** button to return to normal TV display.

Tuning of the Channels

Channel Copy

This function can be utilized after Automatic Tuning.

For example, to copy a TV channel on programme position "2" onto programme position "6";

- 1 Select programme position "2".



- 2 Enter to SEMI-AUTO or MANUAL tuning mode. (Refer to page 12.)

- 3 Select "POSITION" with the Programme UP or DOWN button.

MODE	SEMI
SEARCH	START
POSITION	2
SKIP	OFF
MEMORY	--

- 4 Select position "6" with the VOLUME + or - button.

MODE	SEMI
SEARCH	START
POSITION	6
SKIP	OFF
MEMORY	--

- 5 Select "MEMORY" by pressing the PROGRAMME UP or DOWN button.

- 6 Press the VOLUME + or - button to memorize.

MODE	SEMI
SEARCH	START
POSITION	6
SKIP	OFF
MEMORY	OK

SELECT ADJUST BACK EXIT

- 7 Press the MENU button to return to normal TV display.

Channel Swapping

Use this channel swapping feature to swap the channels between two stored programme position. This feature is particularly useful after automatic tuning.

For example, to swap the channel between programme position "6" and programme position "12".

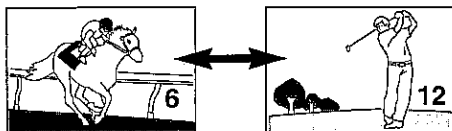

- 1 Select programme position "6".



- 2 Press the SWAP button.



- 3 Press the Digit button, "1" button and then "2" button on the remote control to enter programme number 12. (For example, to enter programme number "3", press "3" button only.)



- 4 Press the SWAP button.



The two TV channels will now have changed places.

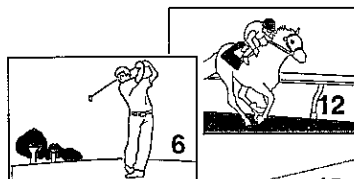

Tuning of the Channels

Skip Channel Set and Cancel

When there is a position you do not use, Position 4 for example, by setting the SKIP Channel function it is possible to jump over this position, when you are selecting a channel using the **PROGRAMME UP/DOWN** or **CHANNEL SCAN** button.



For example, to set programme position "4" as Skip channel ;

1 Enter to SEMI-AUTO or MANUAL tuning mode. (Refer to page 12.)

2 Select "POSITION" with the **PROGRAMME UP** or **DOWN** button.

MODE	SEMI
SEARCH	START
POSITION	6
SKIP	OFF
MEMORY	--

SELECT (X) ADJUST (P) BACK (M) EXIT

3 Press remote control "4" button to select Programme Position 4.

Use the **Digit** button and **PROGRAMME SELECTOR** (Number buttons) to enter Programme Number. Do not use the **VOLUME +** or **-** button to enter programme position in this settings.

MODE	SEMI
SEARCH	START
POSITION	4
SKIP	OFF
MEMORY	--

4 Select "SKIP" by pressing the **PROGRAMME UP** or **DOWN** button, then press the **VOLUME +** or **-** button to set SKIP to ON. To cancel Skip Channel function, set to OFF.

MODE	SEMI
SEARCH	START
POSITION	4
SKIP	ON
MEMORY	--

5 Select "MEMORY" by pressing the **PROGRAMME UP** or **DOWN** button, then press the **VOLUME +** or **-** button for memory.

MODE	SEMI
SEARCH	START
POSITION	4
SKIP	ON
MEMORY	OK

Any number of channels maybe set as Skip Channels.

6 Press the **MENU** button to return to normal TV display.

Setting of the Private Position

Private position is used to restrict of programme positions that you do not want others to watch.

Any position can be set as the Private position.

How to set the Private Position

For example, to set the programme position "15" as the private position.

- 1 Select programme position "15".

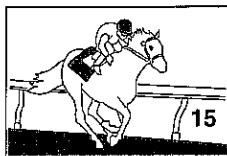

- 2 Press and hold the **RECALL/COLOUR SYSTEM** button for more than 2 seconds.

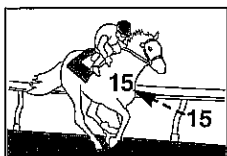

The programme number "15" will shift to centre of the screen.

- 3 Press the **MENU** button.



The picture will disappear, and "X 15" will be display on the screen.

The private position setting is now completed.

To view a programme on Private Position

- 1 Select private position (In this case position "15").



- 2 Press and hold the **RECALL/COLOUR SYSTEM** button for more than 2 seconds.



- 3 Press the **RECALL/COLOUR** button for watching a TV programme.



Note: The position "15" is still in the private position.

labelling of the private position

- 1 Select private position (position "15").



- 2 Press and hold the **RECALL/COLOUR SYSTEM** button for more than 2 seconds.

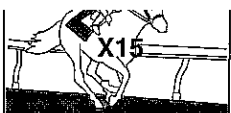

- 3 Press the **MENU** button .

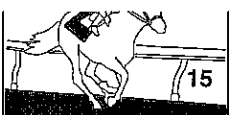

The private position is now cancelled.

Connecting other Equipment

Connecting to the AV Input Jacks

Connect the video and audio outputs of a VCR, video disc player, etc. to the input jacks of this TV set. Tapes and discs can be played back.

Connecting to the Rear AV Input Jacks

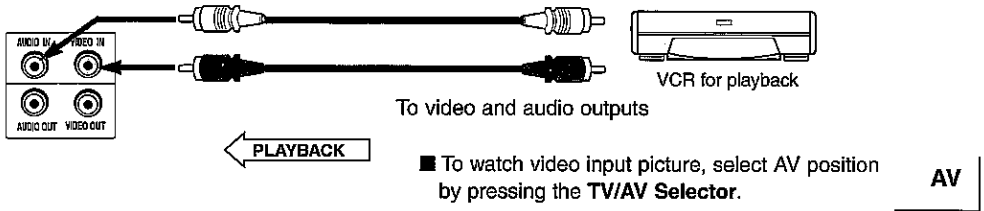

Connecting to the Front AV Input Jacks

It is convenient to use the AV input jack on the front panel for equipment that is often connected and disconnected.

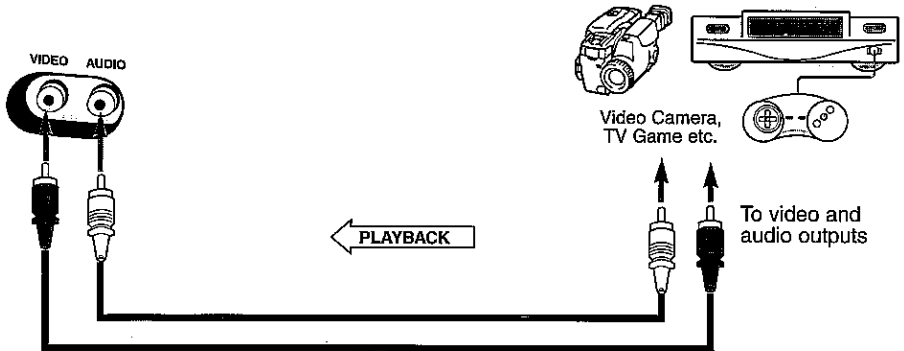

Note: When signals are input both to the Front AV Input Jacks and to the Rear AV Input Jacks, the signal input to the Front AV Input Jacks takes priority.

■ You can select a TV programme while watching a playback from a VCR

For example:

- To select programme position "9" while watching a playback from external VCR, press "9" button of the remote control. The TV set returns to the TV mode and programme "9" will be selected.
- To select the programme position "26", press **Digit** (---) button, "2" then "6" button. Then TV set returns to the TV mode and programme position "26" will be selected.

Note: Pressing either of the **PROGRAMME UP** or **DOWN** buttons of the remote control or the TV will return the TV to the TV mode.

Connecting other Equipment

Selecting the Colour System in AV mode

Depending on the type of video tape or connected AV equipment being used, it may be necessary to select colour system. In this case, press the **RECALL/COLOUR SYSTEM** button and select a suitable colour system.

Each time the **RECALL/COLOUR SYSTEM** button is pressed, colour system is changed as follows;

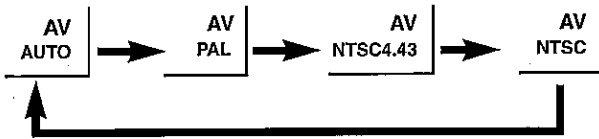

Colour system setting for AV position is automatically stored in the memory.

Connecting to the Monitor Output Jacks

The picture signal being displayed on the TV screen is output through the Monitor Output Jacks. Use these terminals to record TV broadcasts and for video dubbing from AV input terminals.

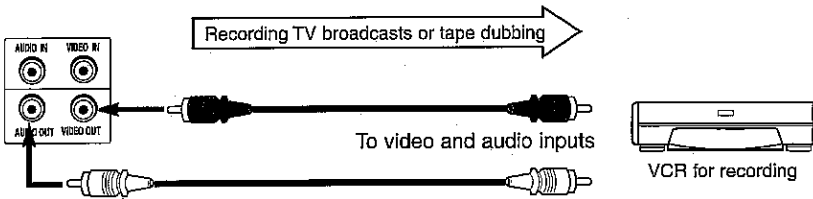

■ To record TV programme, select TV mode by pressing the **TV/AV Selector** and record the desired programme.

■ To dub video from the AV terminal input, select AV position by pressing the **TV/AV Selector**.

15 TV mode

AV

AV Connection to the Aerial Socket

The AV apparatus can also be connected to the aerial socket of your TV receiver.

Presetting to watch the video input

1. Playback the VCR.
2. Tune a VCR playback in programme position that you want. (See Semi-Auto Tuning and Manual Tuning on page 12.)

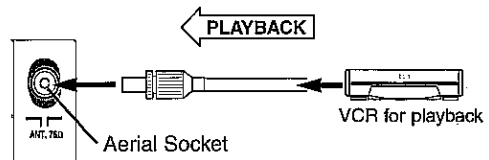

For further details concerning this connection and adjustment, refer to the operating instructions for the AV equipment.

Helpful Hints - Problems/Solutions

Before requesting service check the following chart.

Problem: Check these Conditions / Try these solutions:

No picture, no sound	<ul style="list-style-type: none">● Check if TV is plugged in.● Try a different channel, if OK, probably station trouble.
Poor picture, sound OK	<ul style="list-style-type: none">● Adjust Brightness or Contrast control.● Adjust Fine Tuning. (See page 10.)● Check aerial connection.
No colour, Picture OK	<ul style="list-style-type: none">● Adjust Colour or Tint control.● Adjust Fine Tuning. (See page 10.)● Check aerial connection.● Is the programme in colour? Try a different channel.
Weak picture	<ul style="list-style-type: none">● Check aerial connection on back of TV set.● Check aerial for broken wires.● Re-orient aerial.
No sound or poor sound.	<ul style="list-style-type: none">● Sound Mute may be on. Press the SOUND MUTE button on the remote control.● Adjust Volume.● May be station trouble. Try a different channel.
Remote Control will not work.	<ul style="list-style-type: none">● Check batteries. Replace batteries.● Check if TV set is plugged in. Aim remote control towards front of TV.
Cannot select or scan some channels.	<ul style="list-style-type: none">● Channel may be removed from memory. Add channel to memory manually. (See "Skip Channel Set and Cancel" on page 14.)● Check aerial connection.
Blue screen with AV is displayed	<ul style="list-style-type: none">● Check AV connection. Press the TV/AV Selection button.● Check external equipment. Switch on external equipment.
Black screen with X and programme position displayed.	<ul style="list-style-type: none">● Check to see if channel is set as the Private Position. See "Setting of the Private Position" on page 15.
Cabinet makes popping sound.	<ul style="list-style-type: none">● This is a normal condition during warm-up and cool down of the plastic cabinet parts.

The following faults are not caused by the receiver:

"GHOSTS"

Reflections of signals from mountains or high buildings will cause multiple images, called "Ghosts". These abnormal conditions can be reduced to minimum by repositioning aerial or by installing new one suited for your area.

"INTERFERENCE"

Interference may be caused by electrical appliances, car ignition systems, etc. This should normally be a temporary condition, but should this interference persist, contact your dealer.

Care and Cleaning

The surface of the cabinet can be damaged if not properly maintained. Many common household aerosol sprays, cleaning agents, solvents and polishes will cause permanent damage to the fine surface.

1. Unplug the power cord before cleaning the Television.

2. Clean the screen with a soft cloth dampened with glass cleaner or warm water.

3. Clean the cabinet with a soft cloth dampened with a mild household detergent and warm water. Dry thoroughly.

Note: NEVER spray liquids on the screen because they can run down and drip onto the chassis. This may cause component failure not covered under Warranty.

Specifications

Power Source AC220-240 Volts, 50/60Hz

Colour System PAL (AV input: PAL/NTSC4.43/ NTSC/PAL-60Hz)

Sound System B/G

Channel Coverage [Model CP14SR1Z, CP20SR1Z]

Australia

VHF: 0 - 11, 5A

UHF: 28 - 69

CATV: S1 - S41, X, Y, Z, Z+1, Z+2

New Zealand

VHF: 1 - 11

UHF: 21 - 69

CATV: S1 - S41, X, Y, Z, Z+1, Z+2

[Model CA14SR1Z, CA14SA1, CA20SR1Z, CA21SA1]

VHF: E2 - E12

UHF: 21 - 69

CATV: S1 - S41, X, Y, Z, Z+1, Z+2

Aerial input impedance 75 Ω

Audio output (RMS) Model CP14SR1Z, CA14SR1Z, CP20SR1Z, CA20SR1Z: 3 W
Model CA14SA1, CA21SA1: 5W

Speaker Model CP14SR1Z, CA14SR1Z, CP20SR1Z, CA20SR1Z: 5 cm x 9 cm x 1pc.
Model CA14SA1, CA21SA1: \varnothing 8 cm x 1pc.

Ext. terminals

Video inputs: Phone Jack x 2 (1.0Vp-p, impedance 75 Ω)

Audio inputs: Phone Jack x 2 (436mVrms, impedance more than 40K Ω)

Video monitor outputs: Phone Jack x 1 (1.0Vp-p, impedance 75 Ω)

Audio monitor outputs: Phone Jack x 1 (436mVrms, impedance less than 600 Ω)

Dimension

Model CP14SR1Z, CA14SR1Z: 363 (W) x 346 (H) x 366 (D)mm

Model CP20SR1Z, CA20SR1Z: 496 (W) x 445.5 (H) x 470 (D)mm

Model CA14SA1: 364.5 (W) x 361.7 (H) x 375.8 (D)mm

Model CA21SA1: 501 (W) x 475.5 (H) x 401.5 (D)mm

Weight

Model CP14SR1Z, CA14SR1Z: approx. 8.6Kg

Model CP20SR1Z, CA20SR1Z: approx. 17.2 Kg

Model CA14SA1: approx. 8.6Kg

Model CA21SA1: approx. 20.5Kg

Specifications subject to change without notice.

Part No. 1AA6P1P3598 - A C2CV-A (AC5-A)

SANYO

SANYO ELECTRIC Co., Ltd.