



## INSTRUCTION MANUAL

**CA29EF1(V)**  
**CP29EF1(V)**  
**CP29EF1K**

**Colour Television**

***Flat Screen***  
***Multi System***  
***CATV Hyper Band***  
***256 Programmes with Automatic Tuning***  
***AV Stereo Sound System***  
***DVD Input with Video Component***

# Warnings and Cautions

## Warning

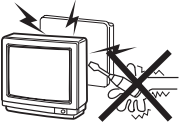

High voltages are used in the operation of this television receiver. Do not remove the cabinet back from your set. Refer servicing to qualified service personnel.



Do not drop or push objects into the television cabinet slots or openings. Never spill any kind of liquid on the television receiver.

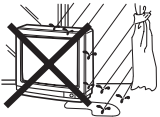

To prevent fire or electrical shock hazard, do not expose the television receiver to rain or moisture. The television shall not be exposed to dripping or splashing and that no objects filled with liquids, such as vases, shall be placed on the television.

## Caution



Never stand on, lean on or push suddenly the television or its stand. You should pay special attention to children. Serious injury may result if it should fall.

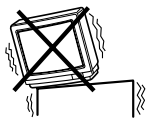

Do not place your television on an unstable cart, stand, shelf or table. Serious injury to an individual, and damage to the television, may result if it should fall.

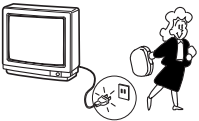

At installation of the unit, the plug of power cord shall remain accessible and readily operable to disconnect the unit from the wall outlet.

When the television receiver is not used for an extended period of time, it is advisable to disconnect the AC power cord from the AC outlet.

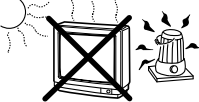

Avoid exposing the television receiver to direct sunlight and other source of the heat.

Do not stand the television receiver directly on other products which give off heat. E.g. video cassette players, audio amplifiers.



Do not block the ventilation holes in the back cover. Adequate ventilation is essential to prevent failure of electrical components.

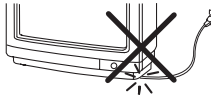

Do not squash power supply cord under the television receiver.

Minimum distances

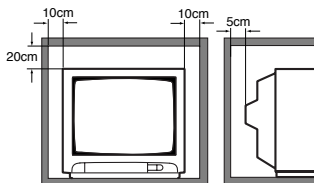

If the television is to be built into a compartment or similarly enclosed, the minimum distances must be maintained.

Heat build-up can reduce the service life of your television, and can also be dangerous.

<b>Warnings and Cautions</b> .....	2
<b>Contents</b> .....	3
<b>Plug &amp; Play</b> .....	3
<b>Front Control</b> .....	4-5
<b>Remote Control Transmitter</b> .....	6
Battery Installation of the Remote Control Transmitter .....	6
<b>General Operation</b>	
Remote Control Operation .....	7
OFF TIMER .....	8
ON TIMER .....	8
<b>Colour and Sound System</b>	
Setting the Colour System .....	8
Setting the Sound system .....	8-9
<b>Picture Adjustment</b> .....	9-10
<b>Audio Adjustment</b> .....	10
<b>Tuning of the Channels</b>	
Automatic Tuning .....	11
Semi-Auto Tuning and Manual Tuning. . .	11
Channel Copy .....	12
Channel Swapping .....	12
Skip Channel Set and Cancel .....	12-13
<b>Setting the Private Position</b> .....	13
<b>Setting the OSD Language</b> .....	14
<b>Connecting to Other Equipment</b> .....	14
Connecting to the Rear AV1 Input Jacks .....	14-15
Selecting the Colour System in AV Mode .....	15
Connecting to a DVD Player with AV1(DVD) Video Component Output terminal . . .	15
Connecting to the Front AV2 Input Jacks .....	16
Connecting to the Monitor Output Jacks .....	16
AV Connection to the Aerial Socket . . .	16
<b>Aerial Connection</b> .....	17
<b>Care and Cleaning</b> .....	17
<b>Specifications</b> .....	18
<b>Helpful</b>	
<b>Hints-Problems/Solutions</b> .....	19

## Automatic setting up channels

This TV set provides a self-automatic tuning and sorting system function called “**Plug & Play**”. It automatically begins searching and storing of all available channels when switching-on the TV set for the first time.

### Let's start !

- 1 Connect power cord of the TV set to a wall outlet, and turn on the TV set by pressing the **Mains ON/OFF** button. Self-automatic tuning system will be started as follows;

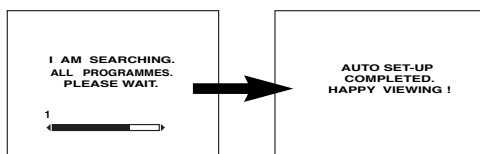

After completing this procedure, the programme position **1** is selected and the ending messages on the screen.

**Note:** The Plug & Play can be cancelled at any time by pressing the **MENU** button.

- 2 Press any of the control buttons to make the ending message disappear. Or will automatically return to normal TV display after 10 seconds.

 This procedure only appears at the first switch-on time.

- If no TV stations are found, the display shown below will appear. Please check if the antenna is connected properly.



If it isn't connected properly, connect antenna and Automatic Tuning will be reset.

# Front Control

Each button listed in this section has the same function as it's corresponding button on the remote control.

## Model CA29EF1(V)

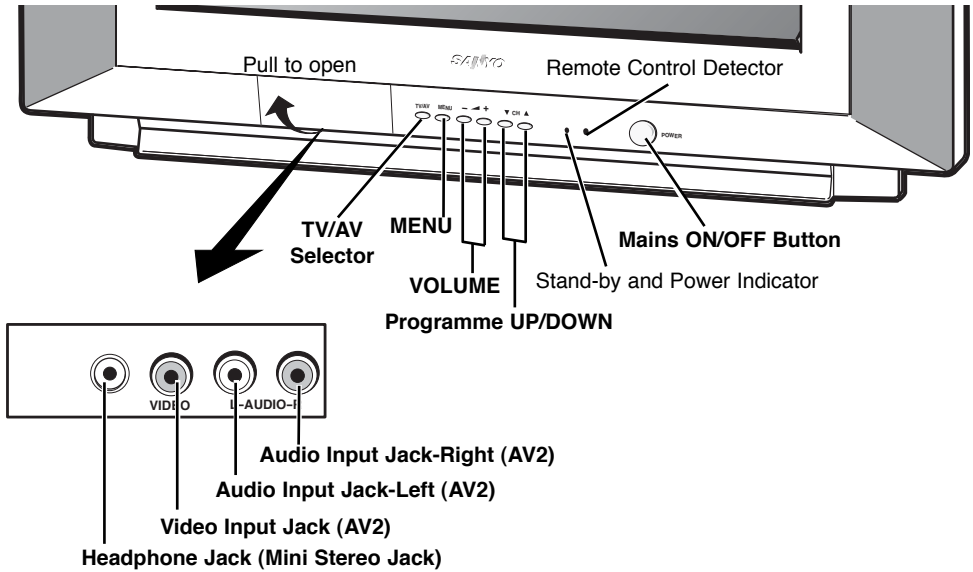

# Front Control

Each button listed in this section has the same function as it's corresponding button on the remote control.

## Model CP29EF1(V), CP29EF1K

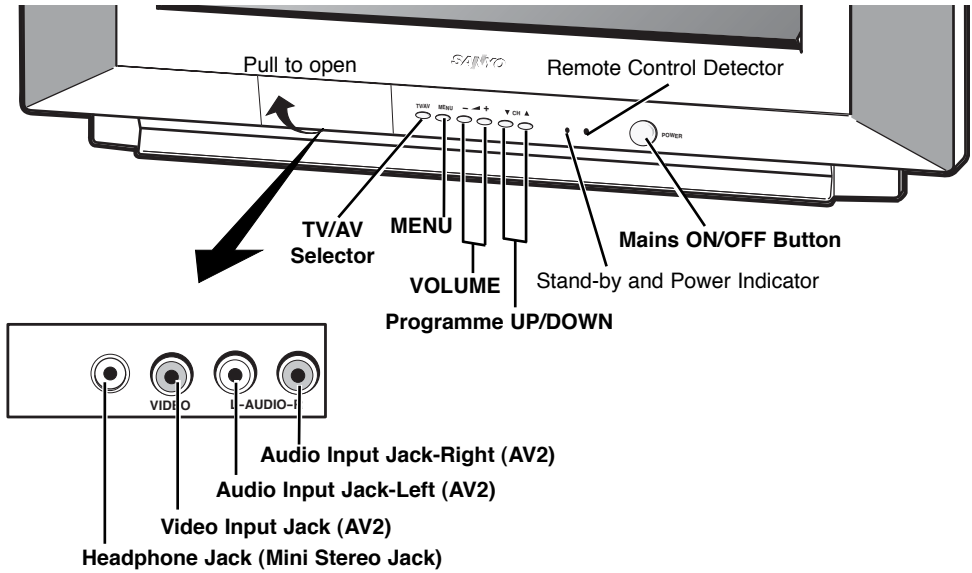

# Remote Control Transmitter

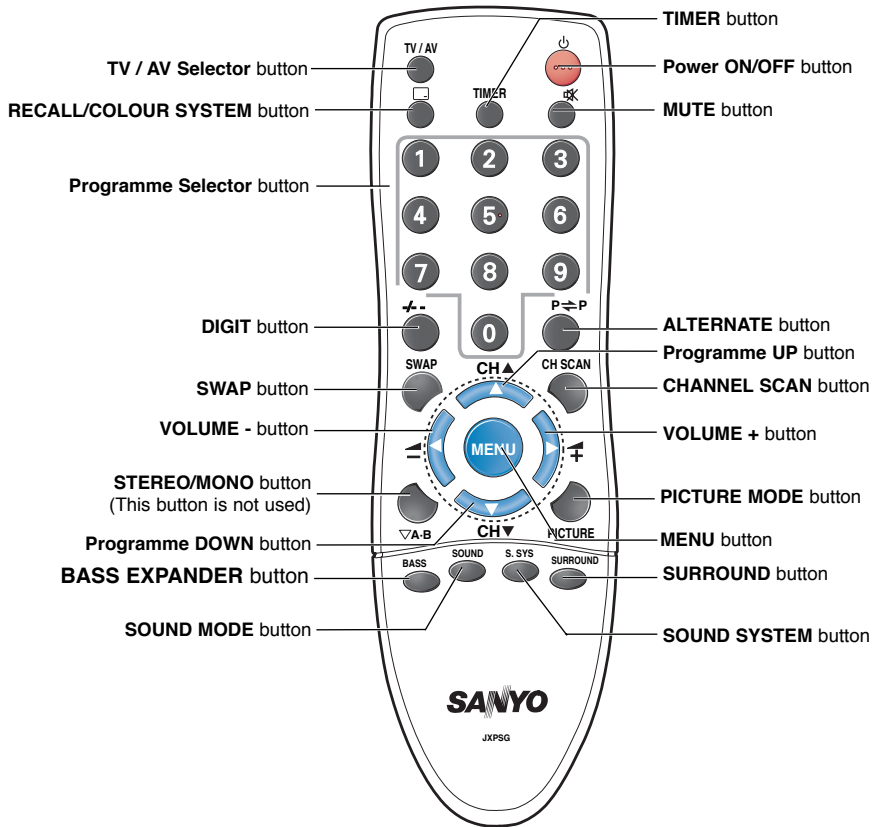

















## Battery Installation of the Remote Control Transmitter

1. Open the battery cover.
2. Install two "AA" 1.5 volt batteries so that the "+" and "-" marks on the batteries match the "+" and "-" marks inside the unit.
3. Close the battery cover.

**Note:** Replace the batteries when the TV set is showing the following symptoms:  
Operation is unsteady or erratic, sometimes the TV set does not work with transmitter.  
Discharged batteries may leak and damage the unit. The normal life of batteries should be from nine to ten months.

# General Operation

## Remote Control Operation

-  **Standby/Power-on**  
To switch the TV on and off. For shutting off a power supply completely, Press the **Mains ON/OFF** button on the front control of TV set.
-  **Sound mute**  
To switch the sound from the speakers. The sound changes as follows; normal -> mute (⊘).
-  **Timer**  
To Adjust Timer function OFF-TIMER -> ON TIMER -> ON PROGRAM
-  **Recall/Colour system selector**  
To display the programme information on the screen.  
It also operates as Colour system selector if the clear picture cannot be obtained even when the broadcasting or AV signal is received.  
Colour System and Sound System (SIF) could be changed in SEMI-AUTO and MANUAL TUNING operation.
-  **Direct programme selector**  
For direct access to programmes using the **(0-9) numeric** button. For selection of analogue programme position 10 - 255, Example: for programme position 17, Press the **Digit** button, press "1" button. Press "7" button. For programme position 125 Press the **Digit** button twice. Press "2" button. Press "5" button. For programme position 225 Press the **Digit** button 3 times. Press "2" button. Press "5" button.
-  **Alternate**  
To select the previous position and the present position.
-  **Volume Up/Down**  
To adjust the sound volume level . Also operates as left (◀) and right (▶) cursor.
-  **Programme down/up**  
To select the next programme number or previous programme number. Also operates as up (▲) and down (▼) cursor.
-  **Swap**  
To swap the channels between two stored programme positions
-  **Sound Mode**  
To select Sound mode; PERSONAL, MUSIC, TALK, NORMAL.
-  **This button is not used**
-  **Picture Mode**  
To select Picture mode; PERSONAL, DYNAMIC, NATURAL, ECO, GAME.
-  **Bass Expander**  
Press the **Bass Expander** button to switch this function ON or OFF.
-  **Sound System**  
To select optimum sound system (BG → I → DK → M).
-  **Surround**  
To activate Surround function.
-  **Menu**  
To Call up the TV MENU.

# General Operation /Colour and Sound System

## OFF TIMER

The OFF TIMER will switch off the TV automatically after 30 minutes, 1 hour, 1 hour and 30 minutes, or 2 hours.

- 1 Press the **TIMER** button. 
- 2 Press the **VOLUME (+ or -)** button to select the time period.

- Just one minute before switching off the TV, "OFF 0:01" will be display on the screen.
- To cancel the OFF TIMER, select "OFF 0:00" by pressing the **VOLUME (+ or -)** button.
- The OFF TIMER cancels when the TV set is turned off or if a power failure occurs.

## ON TIMER

When the ON TIMER is set. TV will automatically be switched On to the selected programme position when the specified time has elapsed.

- 1 Press the **TIMER** button twice.

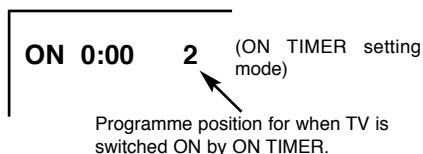

- 2 Press the **VOLUME (+ or -)** button. The set time will be increased or decreased by 10 minutes each time the button is pressed ; the maximum time which can be set is 24 hours.
- 3 Use Direct Programme Selection to insert programme position for when TV is switched on by ON TIMER. (see page 7.)

- If no operation is performed after the TV has been switched on by the ON TIMER, such as if you are not at home, the TV will be automatically switched off after approximately 2 hours
- If the TV is already switched on when the time set for the ON TIMER has been reached, only the programme position will be changed to the set programme position.
- Cancelling ON TIMER. To cancel the ON TIMER, press the **VOLUME (+ or -)** button to set it to "ON 0:00" while the ON TIMER screen is shown. Switching off the TV by pressing the **Mains ON/OFF** button will also cancel the ON TIMER settings.

## Colour and Sound System

### Setting of the Colour System

Normally, set the colour system to "AUTO", if the clear picture cannot be obtained even when the broadcasting or AV signal is received, press the **RECALL/COLOUR SYSTEM** button repeatedly until the optimum image can be produced.

(Refer to **Broadcast Transmission System List** indicated by the last of this page in a setup of Colour System.)

Each time the **RECALL/COLOUR SYSTEM** button is pressed, colour system changes as follows;

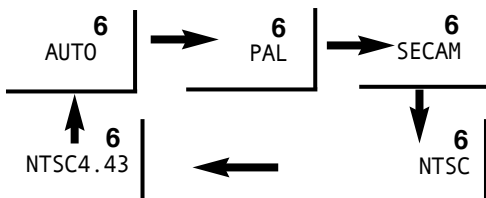

Note: Colour system is displayed according as Colour system option.

### Setting of the Sound System

To set the sound system, make it during Semi-Auto Tuning or Manual Tuning mode.

When the sound is not clear or no sound is produced on a programme number position, select sound system repeatedly until the optimum sound is obtained.

(Refer to **Broadcast Transmission System List** indicated by the last of this page in a setup of Sound System.)

#### To select sound system:

- Press the **SOUND SYSTEM** button to select the sound system directly. The sound system will be memorized automatically.



# Colour and Sound System / Picture Adjustment

or:

- 1) Select "SIF" with the **Programme UP** or **DOWN** button in the Semi-auto or Manual Tuning mode. Then press the **VOLUME (+** or **-)** button to select a optimum sound system.

(Semi-Auto or Manual Tuning mode)

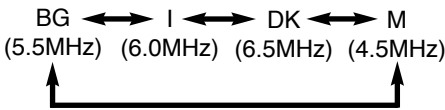
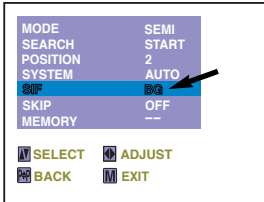

- 2) To enter a sound system selection into the memory, select "MEMORY" and press the **VOLUME +** or **-** button.

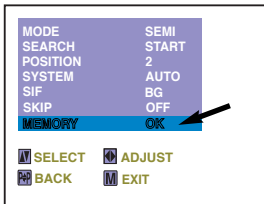

## Broadcast Transmission System List

Area	Country	Colour System	Sound System
Middle East	Union of Arab Emirates, Kuwait, Oman, Qatar, Yemen, Bahrain, etc.	PAL	B/G
Asia	Indonesia, Malaysia, Singapore, Thailand, etc.		
	China, etc.	PAL	D/K
	Hong kong	PAL	I
	Saudi Arabia, Iraq, Iran, Lebanon, etc.	SECAM	B/G
	Russian Federation, etc.	SECAM	D/K
	Myanmar, etc.	NTSC	M
Oceania	Australia, New Zealand, etc.	PAL	B/G

## Picture Adjustment

### Picture Adjustment Menu

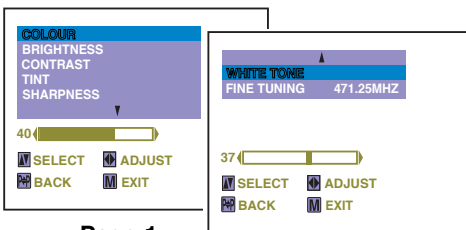

Page 1

Page 2

The 2nd page is not displayed when there is no TINT adjustment.

### Picture Adjustment Item

**COLOUR** : Adjusts colour intensity.

**BRIGHT** : Adjusts picture brightness.

**CONTRAST** : Adjusts picture contrast.

**TINT** : Adjust colour tints. (Displayed only on NTSC or NTSC4.43 system signal reception.)

**SHARPNESS** : Adjusts picture detail.

**WHITE TONE** : Adjusts white balance.

**FINE TUNING** : Fine tuning in case of weak broadcast signal or poor reception. Only displayed in TV mode. Will not be displayed in AV mode.

# Picture Adjustment / Audio Adjustment

## Basic Picture Adjustment Operation

- 1 Press the **MENU** button for MAIN menu display.

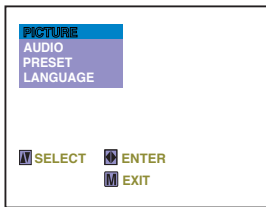

(MAIN MENU)

- 2 When "PICTURE" is not selected, select "PICTURE" with the **Programme UP** or **DOWN** button.



- 3 Press the **VOLUME +** or **-** button to display Picture Adjustment menu.

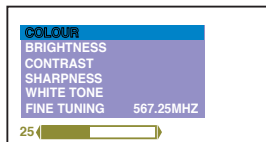

- To return to Main menu, press the **ALTERNATE** button.
- To return to the normal TV mode, press the **MENU** button. ( Or will automatically return to the normal TV mode after 20 seconds.)

- 4 Select desired control by pressing the **Programme UP** or **DOWN** button.

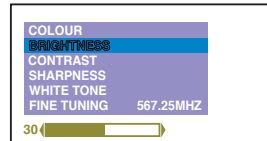

- 5 Press the **VOLUME +** or **-** button to alter settings.

## Audio Adjustment

### Audio Adjustment Menu

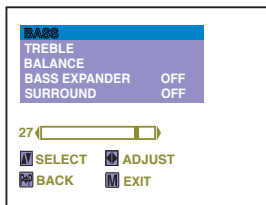

### Audio Adjustment Operation

- 1 Press the **MENU** button for MAIN menu display.
- 2 Select "AUDIO " by pressing the **Programme UP** or **DOWN** button.



- 3 Press the **VOLUME +** or **-** button for Audio Adjustment menu display.

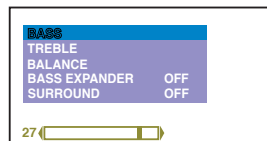

- To return to Main menu, press the **ALTERNATE** button.
- To return to normal TV mode, press the **MENU** button. (Or will automatically return to normal TV mode after 20 seconds.)

### Audio Adjustment Item

**BASS** : Bass Adjustment

**TREBLE** : Treble Adjustment

**BALANCE** : Left/right speaker volume balance adjustment

**BASS EXPANDER** : Operates BASS EXPANDER on and off

**SURROUND** :Operates SURROUND on and off.

**Note:** If SURROUND "on", BALANCE has no function.

**Note:** When the stereo signal is inputted from the right and left audio input terminals in the AV mode, surround mode is changed as follows; "**SURROUND**" ON and "**SURROUND OFF**".

# Tuning of the Channels

Up to 256 broadcast stations in your reception area can be stored in the electronic memory.

There are three ways of tuning as follows;

## 1. Automatic Tuning (the basic way):

All receivable channels are automatically tuned in and memorized in consecutive programme position.

## 2. Semi-Auto Tuning:

Use to preset a receivable channel in any desired programme position, e.g. the position with the same number as the channel.

## 3. Manual Tuning:

Manually tune a channel if it cannot be automatically tuned, such as when the signal is poor.

## Automatic Tuning

1 Press the **MENU** button for MAIN menu display.

2 Select "PRESET" by pressing the **Programme UP** or **DOWN** button.



3 Press the **VOLUME +** or **-** button for PRESET menu display. On entering PRESET display, Automatic Tuning will be selected initially.

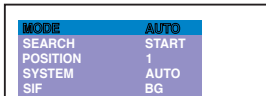

4 Select "SEARCH" by pressing the **Programme UP** or **DOWN** button.

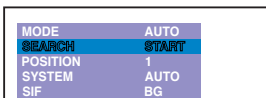

5 Press the **VOLUME (+)** button to start channel tuning.

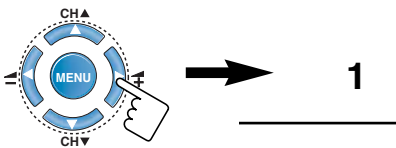

After all receivable channels have been found and stored, the TV set automatically returns to programme position "1".

■ The Automatic Tuning operation can be cancelled at any time by pressing the **Programme UP** or **DOWN** button.

## Semi-Auto Tuning and Manual Tuning

1 Press the **MENU** button for MAIN menu display.

2 Select "PRESET" by pressing the **Programme UP** or **DOWN** button.

3 Press the **VOLUME +** or **-** button for PRESET menu display. On entering PRESET display, Automatic Tuning will be selected initially.

4 Select "SEMI" or "MANUAL" by pressing the **VOLUME +** or **-** button.

5 Select "SEARCH" by pressing the **Programme UP** or **DOWN** button.

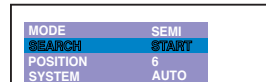

## Semi-Auto Tuning:

Press and release the **VOLUME +** or **-** button to search for required TV station. Once a station is located, tuning will automatically stop. Continue till desired channel is located.

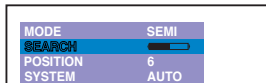

## Manual Tuning :

Press and hold the **VOLUME +** or **-** button to search for required TV station.

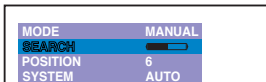

The **VOLUME +** button will move tuning toward the higher frequencies, and the **VOLUME -** button will move tuning toward the lower frequencies.

6 Once desired channel is located, select "MEMORY" by pressing the **Programme UP** or **DOWN** button.

7 Press the **VOLUME +** or **-** button to enter the desired channel into memory.

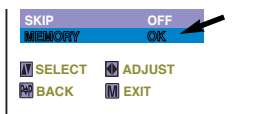

To preset other Programme Positions, repeat steps 5–8.

8 Press the **MENU** button to return to normal TV display.

# Tuning of the Channels

## Channel Copy

This function can be utilized after Automatic Tuning.

For example, to copy a TV channel on programme position "2" onto programme position "6";

- 1 Select programme position "2".



- 2 Enter to SEMI-AUTO or MANUAL tuning mode. (Refer to page 11.)

- 3 Select "POSITION" with the Programme UP or DOWN button.

- 4 Select position "6" with the VOLUME + or - button.

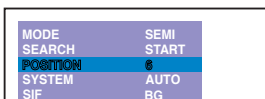

- 5 Select "MEMORY" by pressing the Programme UP or DOWN button.

- 6 Press the VOLUME + or - button to memorize.

- 7 Press the MENU button to return to normal TV display.

## Channel Swapping

Use this channel swapping feature to swap the channels between two stored programme position. This feature is particularly useful after automatic tuning.

For example, to swap the channel between programme position "6" and programme position "12".

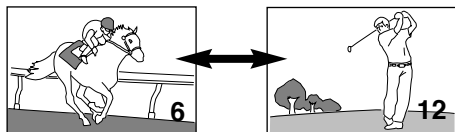

- 1 Select programme position "6".

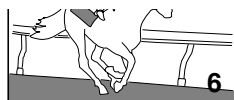

- 2 Press the SWAP button.



- 3 Press the DIGIT button, "1" button and then "2" button on the remote control to enter programme number 12. (For example, to enter programme number "3", press "3" button only.)



The two TV channels will now have changed places.

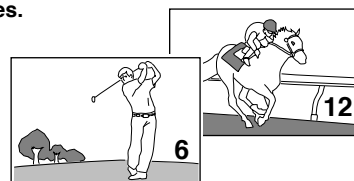

## Skip Channel Set and Cancel

When there is a position you do not use, Position 4 for example, by setting the SKIP Channel function it is possible to jump over this position, when you are selecting a channel using the Programme UP/DOWN or CHANNEL SCAN button.



For example, to set programme position "4" as Skip channel ;

- 1 Enter to SEMI-AUTO or MANUAL tuning mode. (Refer to page 11.)

- 2 Select "POSITION" with the Programme UP or DOWN button.

- 3 Press remote control "4" button to select programme position 4. Use the DIGIT button and Programme Selector (Number buttons) to enter programme number. Do not use the VOLUME + or - button to enter programme position in this settings.

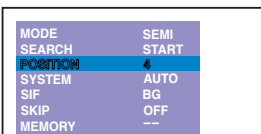

# Tuning of the Channels / Setting of the Private Position

- 4** Select "SKIP" by pressing the **Programme UP** or **DOWN** button, then press the **VOLUME +** or **-** button to set SKIP to ON. To cancel Skip Channel function, set to OFF.

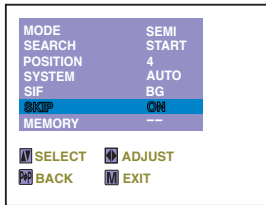

- 5** Select "MEMORY" by pressing the **Programme UP** or **DOWN** button, then press the **VOLUME +** or **-** button for memory.

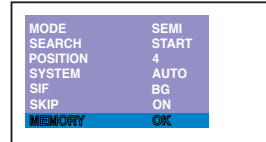

Any number of channels maybe set as Skip Channels.

- 6** Press the **MENU** button to return to normal TV display.

## Setting of the Private Position

Private position is used to restrict of programme positions that you do not want others to watch. Any position can be set as the Private position.

### How To Set the Private Position

For example, to set the programme position "15" as the private position.

- 1** Select programme position "15".

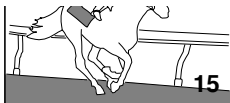

- 2** Press and hold the **RECALL/COLOUR SYSTEM** button for more than 2 seconds.

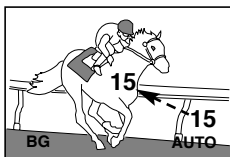

The programme number "15" will shift to centre of the screen.

- 3** Press the **MENU** button.



The picture will disappear, and " 15" will be display on the screen.

The private position setting is now completed.

### To View a Programme on Private Position

- 1** Select private position (In this case position "15").



- 2** Press and hold the **RECALL/COLOUR SYSTEM** button for more than 2 seconds.



- 3** Press the **RECALL/COLOUR SYSTEM** button for watching a TV programme.



**Note:** The position "15" is still in the private position.

### Cancelling of the Private Position

- 1** Select private position (position "15").



- 2** Press and hold the **RECALL/COLOUR SYSTEM** button for more than 2 seconds.



- 3** Press the **MENU** button.

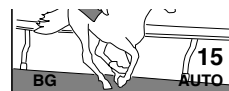

The private position is now cancelled.

## Setting of the OSD Language

- 1 Press the **MENU** button for MAIN menu display.



- 2 Select "LANGUAGE" by pressing the **programme UP** or **DOWN** button.



Select "ENGLISH", "ภาษาไทย", "VIETNAMESE", "РУССКИЙ", "FRANÇAIS", "BAHASA INDONESIA" by pressing the **Programme UP** or **DOWN** button. To return to the normal TV mode, press the **MENU** button.

- 3 Press the **VOLUME +** or **-** button for Language menu display.

- 4 Press the **MENU** button to return to normal TV display.

## Connecting Other Equipment

### Connecting To the Rear AV1 Input Jacks

You may connect the audio and video output terminals of the DVD player or VIDEO recorder to the input terminals of the TV set to enjoy the DVD and VIDEO programs.

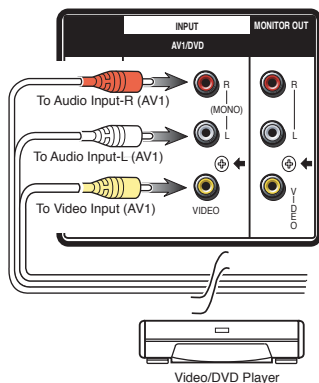

- To watch video input picture, select AV1 position by pressing the **TV/AV Selector**.

**AV1**

When the stereo signal is inputted from the right and left audio input terminals, each time the **SURROUND** button is pressed (or selection of On-screen Menu), surround mode is changed as follows; "SURROUND ON", and "SURROUND OFF".

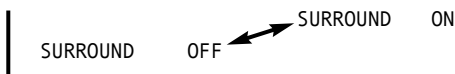

**Note:** The effect of surround is not obtained although the switching of surround is displayed in this monaural connection.

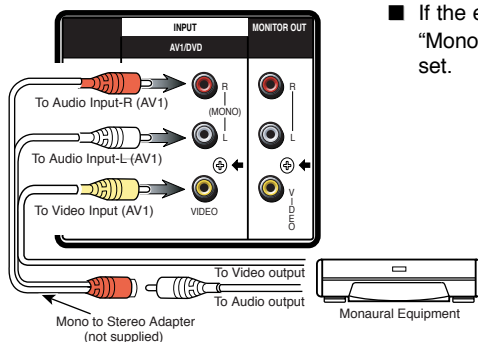

- If the external equipment is a monaural one, Please use "Mono to Stereo Adapter" (not supplied) and connect to TV set.

# Connecting Other Equipment

- When watching a video program input from the AV1 terminal, press the TV/AV button to select AV1. Whenever the TV/AV button is pressed, the mode will change as follows:

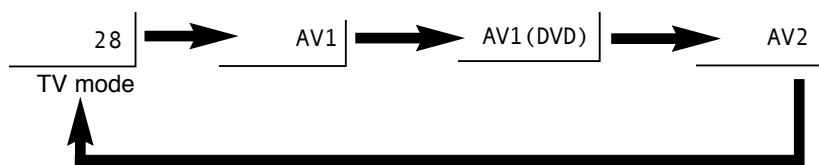

- You can select a TV programme while watching a playback from a VCR

For example:

- To select programme position “9” while watching a playback from external VCR, press “9” button of the remote control. The TV set returns to the TV mode and programme “9” will be selected.
- To select the programme position “26”, press **Digit** (---) button, “2” then “6” button. Then TV set returns to the TV mode and programme position “26” will be selected.

**Note:** Pressing either of the **PROGRAMME UP** or **DOWN** buttons of the remote control or the TV will return the TV to the TV mode.

## Selecting the Colour System in AV Mode

Depending on the type of video tape or connected AV equipment being used, it may be necessary to select colour system. In this case, press the **RECALL/COLOUR SYSTEM** button and select a suitable colour system.

Each time the **RECALL/COLOUR SYSTEM** button is pressed, colour system is changed as follow;

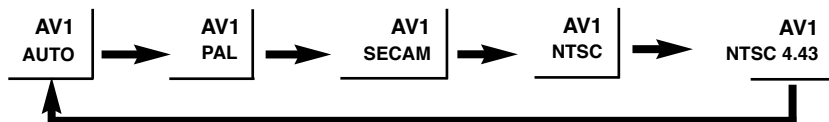

Colour system setting for AV position is automatically stored in the memory.

## Connecting to a DVD Player with AV1 (DVD) Video Component Input Terminal (Y, Cb or Cr)

Connect the component output terminal on your DVD player to the component video input terminal of this product. (NOTE: When a signal of Y,Cb,Cr/Y,Pb,Pr is received, the output signal from monitor output terminal will be corresponding but without colour (black and white image).)

- To watch a program in this connection status, select AV1(DVD).

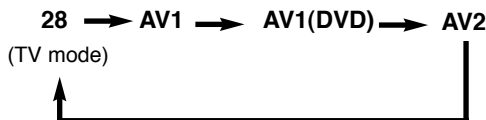

- Make sure the component video terminal (Y, Cb or Cr) is connected correctly.

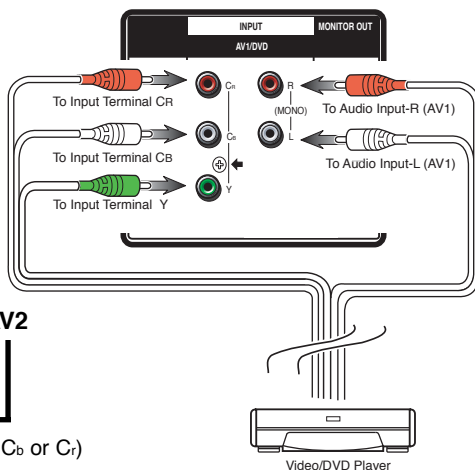

# Connecting Other Equipment

## Connecting to the Front AV2 Input Jacks

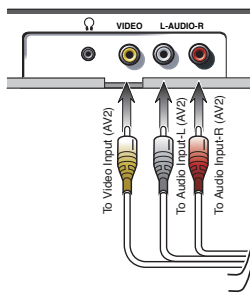

It is convenient to use the AV input jack on the front panel for equipment that is often connected and disconnected.

- To watch the Front AV2 video input picture, select AV2 position by pressing the **TV/AV Selector**.

**AV2**

## Connecting to the Monitor Output Jacks

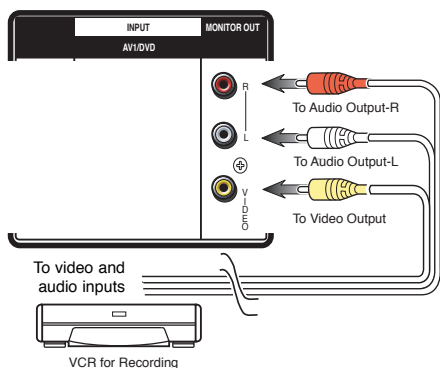

The picture signal being displayed on the TV screen is output through the Monitor Output Jacks. Use these terminals to record TV broadcasts and for video dubbing from AV1 or AV2 input terminals.

- To record TV programme, select TV mode by pressing the **TV/AV Selector** and record the desired programme.

**15** TV mode

- To dub video from the AV1 terminal input, select AV1 position and by pressing the **TV/AV Selector**.

**AV1**

## AV Connection to the Aerial Socket

The AV apparatus can also be connected to the aerial socket of your TV receiver.

### Presetting to watch the video input

1. Playback the VCR .
2. Tune a VCR playback in programme position that you want. (See Semi-Auto Tuning and Manual Tuning on pages 11.)

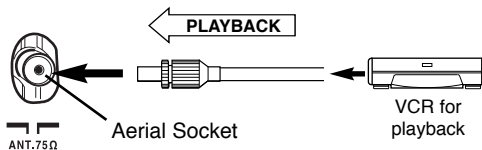

For further details concerning this connection and adjustment, refer to the operating instructions for the AV equipment.



## Aerial Connection

---

### Connecting Outdoor Aerial

Connect the cable with a plug from a UHF (or VHF) aerial to the aerial socket on the cabinet back.

#### Outdoor Aerial

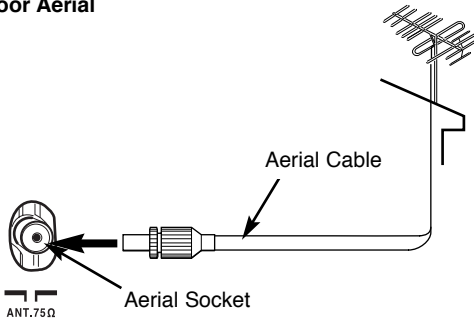

For all aerial circuit problems please consult your local dealer.

## Care and Cleaning

---

The surface of the cabinet can be damaged if not properly maintained. Many common household aerosol sprays, cleaning agents, solvents and polishes will cause permanent damage to the fine surface.

1. **Unplug the power cord before cleaning the Television.**
2. Clean the screen with a soft cloth dampened with glass cleaner or warm water.
3. Clean the cabinet with a soft cloth dampened with a mild household detergent and warm water. Dry thoroughly.

**Note:** *NEVER* spray liquids on the screen because they can run down and drip onto the chassis. This may cause component failure not covered under Warranty.

# Specifications

**Power Source** AC127-270 Volts, 50/60Hz

**Colour System** PAL/SECAM/NTSC4.43/NTSC/PAL-60Hz

**Sound System** BG, I, DK, M

## Channel Coverage

VHF: E2-E12, R1-R12, K1-K9, J1-J12, A2-A13 // 0-11, 5A (AUS), 1-11 (NZ)

UHF: 21-69, A14-A69, J13-J62 // 28-69 (AUS)

CATV: S1-S41, X, Y, Z, Z+1, Z+2

**Aerial input impedance** 75  $\Omega$

**Audio output (RMS)** 7.5W + 7.5W

**Speakers** 6 cm x 12 cm x 2 pcs

## Ext. terminals

DVD Video Component: Composite/Component Y, C<sub>B</sub>, C<sub>R</sub> input

Video Inputs: Phone Jack x 2 (1.0Vp-p, impedance 75  $\Omega$ )

Audio Inputs: Phone Jack (L/R) x 2 (436mVrms, impedance more than 40K $\Omega$ )

Video monitor outputs: Phone Jack x 1 (1.0Vp-p, impedance 75  $\Omega$ )

Audio monitor outputs: Phone Jack (L/R) x 1 (436mVrms, impedance less than 600 $\Omega$ )

Stereo Headphone: Mini Stereo Jack x 1

**Dimension** : 750(W) x 581(H) x 497(D) mm

**Weight** : approx. 38.0Kg

*Specifications subject to change without notice.*

# Helpful Hints - Problems/Solutions

Before requesting service check the following chart.

Problem:	Check these Conditions / Try these solutions:
<b>No picture, no sound</b>	<ul style="list-style-type: none"> <li>● Check if TV is plugged in.</li> <li>● Try a different channel, if OK, probably station trouble.</li> </ul>
<b>Poor picture, sound OK</b>	<ul style="list-style-type: none"> <li>● Adjust Brightness or Contrast control.</li> <li>● Adjust Fine Tuning. (See page 9.) ● Check aerial connection.</li> </ul>
<b>No colour, Picture OK</b>	<ul style="list-style-type: none"> <li>● Adjust Colour or Tint control. ● Adjust Fine Tuning. (See page 9.)</li> <li>● Check aerial connection. ● Is the programme in colour ? Try a different channel.</li> <li>● Select other colour system. (See Setting of the Colour System on page 8.)</li> </ul>
<b>Weak picture</b>	<ul style="list-style-type: none"> <li>● Check aerial connection on back of TV set.</li> <li>● Check aerial for broken wires. ● Re-orient aerial.</li> </ul>
<b>No sound or poor sound.</b>	<ul style="list-style-type: none"> <li>● Sound Mute may be on. Press the <b>SOUND MUTE</b> button on the remote control.</li> <li>● Adjust Volume. ● May be station trouble. Try a different channel.</li> <li>● Select other sound system. (See Setting of the Sound System on page 8-9.)</li> </ul>
<b>Remote Control will not work.</b>	<ul style="list-style-type: none"> <li>● Check batteries. Replace batteries.</li> <li>● Check if TV set is plugged in. Aim remote control towards front of TV.</li> </ul>
<b>Cannot select or scan some channels.</b>	<ul style="list-style-type: none"> <li>● Channel may be removed from memory. Add channel to memory manually. (See "Skip Channel Set and Cancel" on page 12-13.)● Check aerial connection.</li> </ul>
<b>Blue screen with AV1 or AV1(DVD) or AV2 is displayed.</b>	<ul style="list-style-type: none"> <li>● Check AV connection. Press the TV/AV Selection button.</li> <li>● Check external equipment. Switch on external equipment.</li> </ul>
<b>Black screen with  and programme position displayed.</b>	<ul style="list-style-type: none"> <li>● Check to see if channel is set as the Private Position. See "Setting of the Private Position" on page 13.</li> </ul>
<b>Cabinet makes popping sound.</b>	<ul style="list-style-type: none"> <li>● This is a normal condition during warm-up and cool down of the plastic cabinet parts.</li> </ul>
<b>Colour Spot On The CRT</b>	<ul style="list-style-type: none"> <li>● Keep away your TV set from magnetic source, then turn-off your TV set and disconnect TV's power cord from AC outlet, keep this condition about 30-60 minutes and turn-on again your TV set if time is reach. If colour spot is not disappear after this solution have done, please contact your local dealer.</li> </ul>

The following faults are not caused by the receiver:

## "GHOSTS"

Reflections of signals from mountains or high buildings will cause multiple images, called "Ghosts". These abnormal conditions can be reduced to minimum by repositioning aerial or by installing new one suited for your area.

## "INTERFERENCE"

Interference may be caused by electrical appliances, car ignition systems, etc. This should normally be a temporary condition, but should this interference persist, contact your dealer.

## "SLANT"

If the picture of TV set is not properly horizontal (slant), try to change face direction of your TV set. This case may be caused by geo-magnetic on your place where you live.

Part No. 1AA6P1P5464-A BA4E-A (FC7 -AR)

**SANYO**

---

**SANYO ELECTRIC Co., Ltd.**