

TELETEXT  
STEREO

NICAM decoder is built in this TV set.

## Table of contents

|                             | Page  |                                   | Page |
|-----------------------------|-------|-----------------------------------|------|
| Technical data .....        | (1)   | Hold .....                        | (8)  |
| Main supply .....           | (1)   | Double letter height .....        | (8)  |
| Aerial connection .....     | (1~2) | Concealed information .....       | (8)  |
| General operation .....     | (2)   | Alarm clock .....                 | (8)  |
| Tuning                      |       | News flash .....                  | (8)  |
| Automatic tuning .....      | (3)   | Up dated page .....               | (8)  |
| Manual tuning .....         | (3)   | FLOF/LIST .....                   | (9)  |
| Remote control .....        | (4)   | Memory of TEXT pages .....        | (9)  |
| Operation of main remote    |       | VCR use .....                     | (10) |
| control key .....           | (5~6) | Audio monitor terminal .....      | (10) |
| Teletext use                |       | External speaker connection ..... | (10) |
| Page selection .....        | (7)   | 21-pin terminal .....             | (11) |
| Sub coded page access ..... | (7)   | S-VHS VCR connections .....       | (12) |



# Aerial connection

For all aerial circuit problems please consult your local dealer.

Equivalent to DIN 45 325 for combined U/V aerial with 75 ohms coaxial cable.

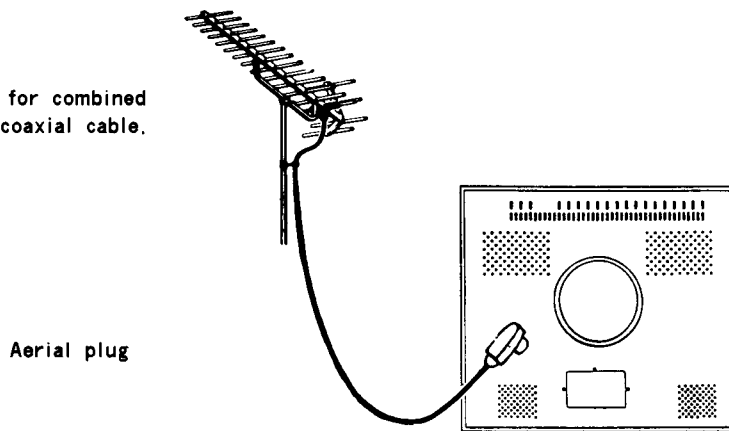

# General operation

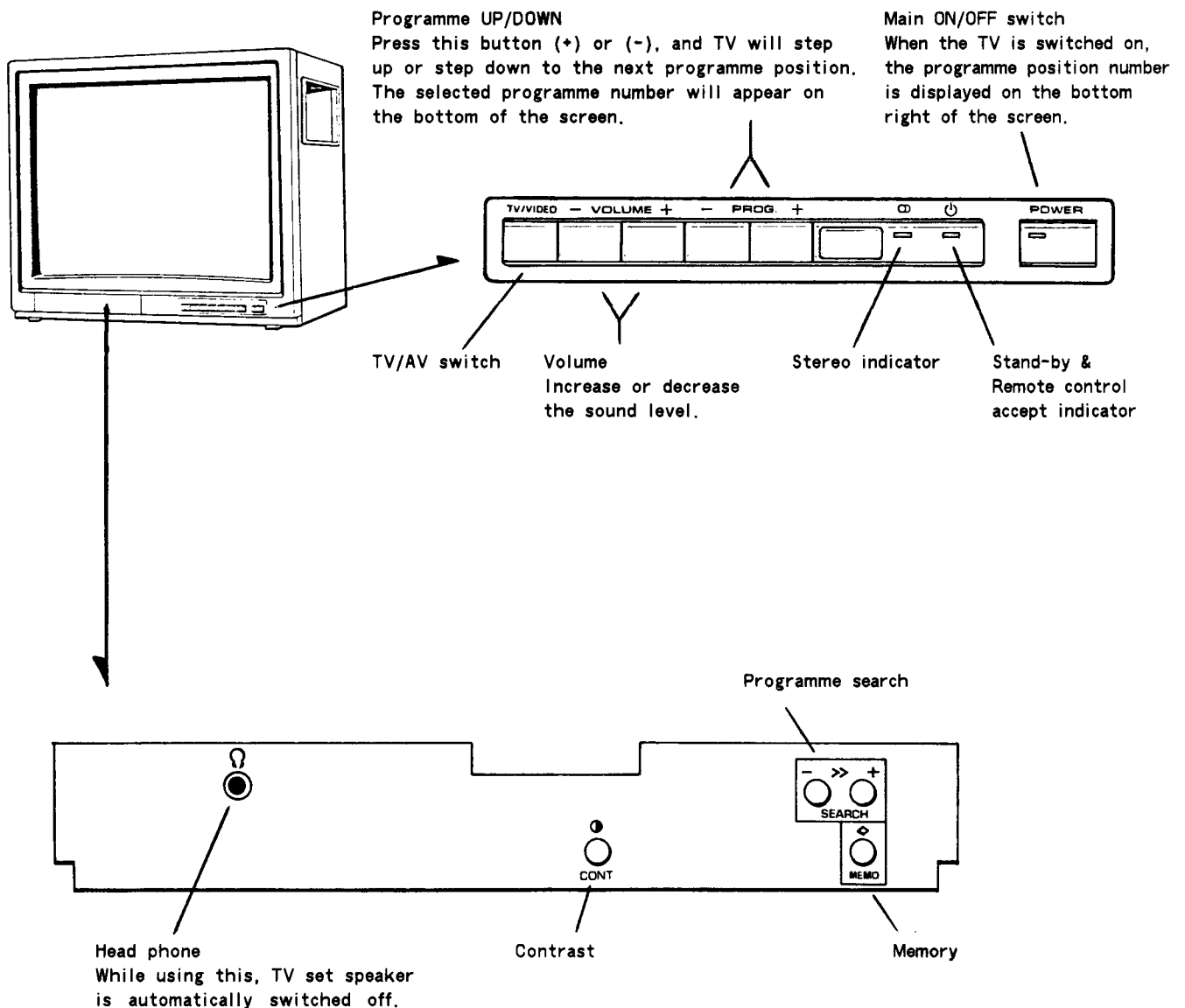

# How to assign TV channel to programme position

This TV set 30 programme positions to enable you to assign 30 TV stations.  
 You can assign the desired TV broadcast stations to the programme positions.  
 After this, if you assign "00" number to all the vacant positions, they can be skipped when you select TV station with search key, you can select only live TV stations you assigned.

## Automatic tuning

Programme and TV channel number on the screen changes as follows:

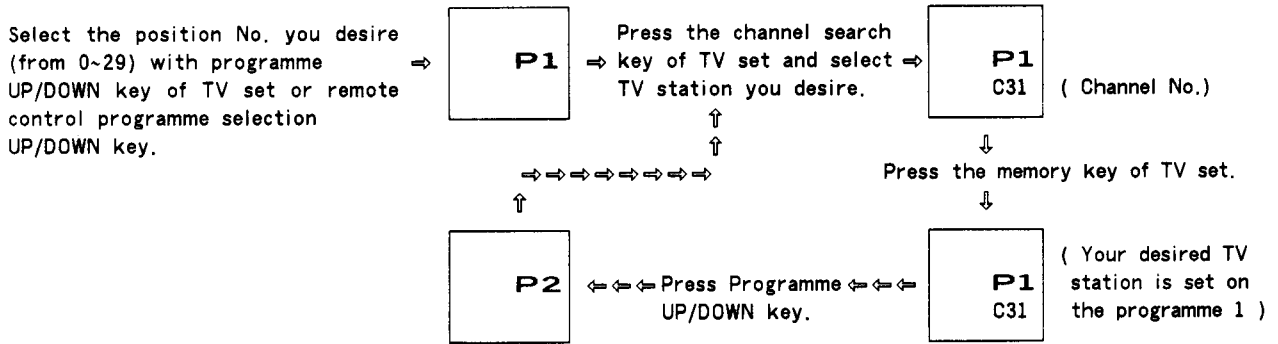

Note: When you select the programme number, you can input with remote control programme key:  
 1. One digit: Press remote control programme number ( e.g. 1, 2, 3 ... )  
 2. Two digits: First press "-/--" key, then press 2 digits of programme number ( e.g. -/--, 1, 2 or -/--, 2, 5 )

## Manual tuning

Programme and TV channel number on the screen changes as follows:

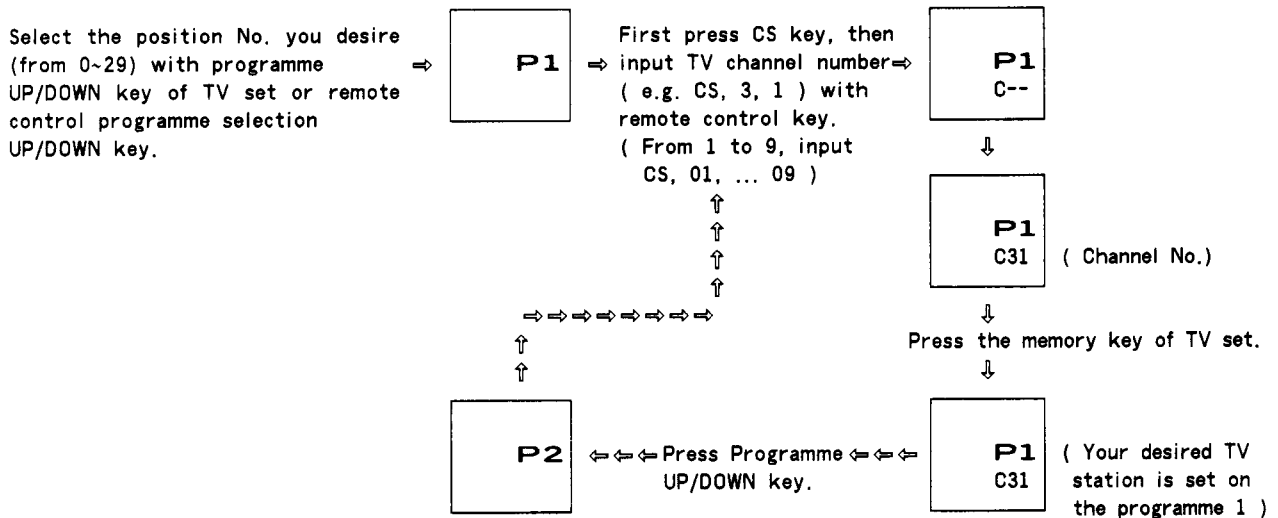

Note: When using a VCR connected to the aerial socket, it would be better to select programme position "0". Because, when you select "0" position, the characters of "VCR" are indicated at the bottom right corner of the TV main screen.

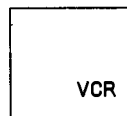

# Remote control

## BATTERY INSTALLATION

1. Remove the battery cover by sliding it in direction of arrow.
2. Install two "AA" 1.5V batteries so that the (+) and (-) marks on the batteries match the (+) and (-) marks inside the unit.
3. Close the battery cover.

Note: Replace the batteries when the TV set is showing the following symptoms: Operation is unsteady or erratic, sometimes the transmitter does not control the TV. Discharged batteries may leak and damage the unit. The normal life of batteries should be about nine months.

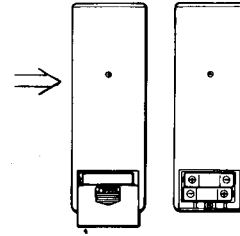

## Remote control key for TV use

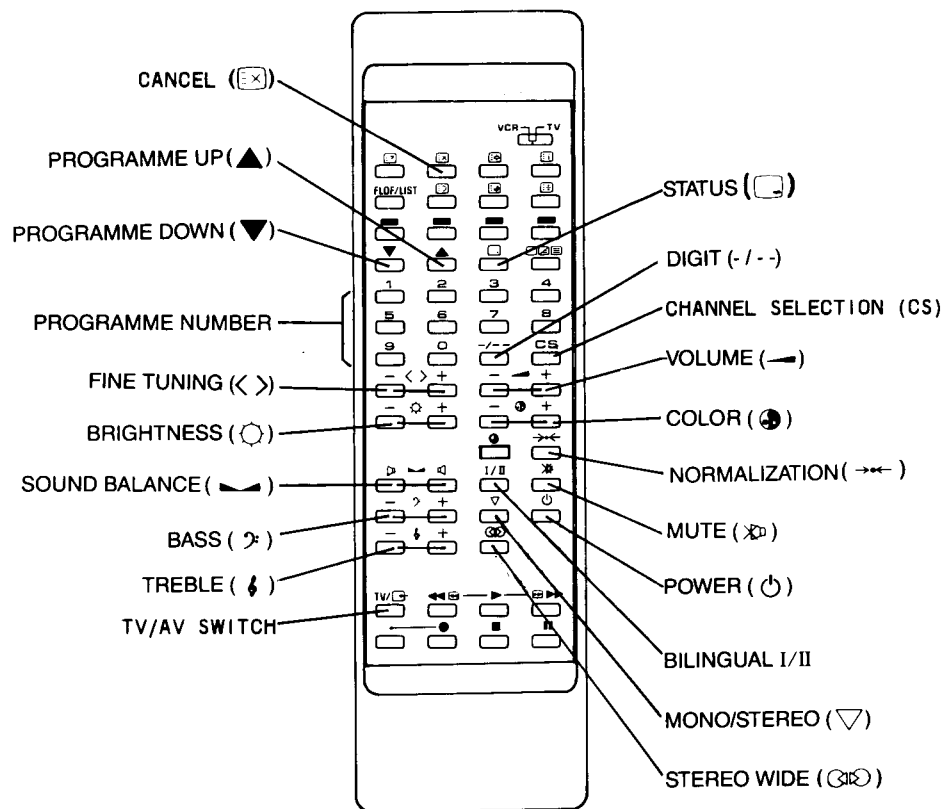

## Operation of main remote control key

### STATUS

When the STATUS key is pressed, the sound mode, the programme number and the channel number of the TV station being received at the time are displayed on the screen for about six seconds.

Note: If the selected TV station is also transmitting teletext, then the time will also be displayed on the top right of the screen for approximately six seconds.

### STATUS

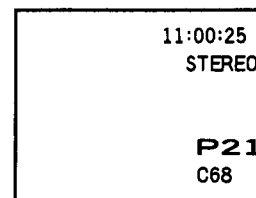

**SOUND MUTE** 

While talking on telephone, you can mute the TV sound by pressing mute key. To switch the sound back on, press it again.

**SOUND MUTE**

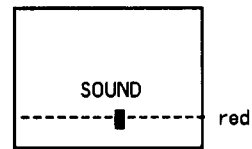

**DISPLAY BAR**

When you press the volume button, colour saturation button, brightness button, balance button, bass button, and treble button of the remote control transmitter, the control indicator bar appears on the bottom of the screen during pressing and for six seconds after releasing. Each control level is indicated by the position of the green thick bar on the dashed line. When the TV set is in AV mode, both the character and the indicator bar are displayed on the TV screen too. Note: The volume, colour, brightness, balance, bass, and treble control levels are maintained in the memory even if the power is switched off.

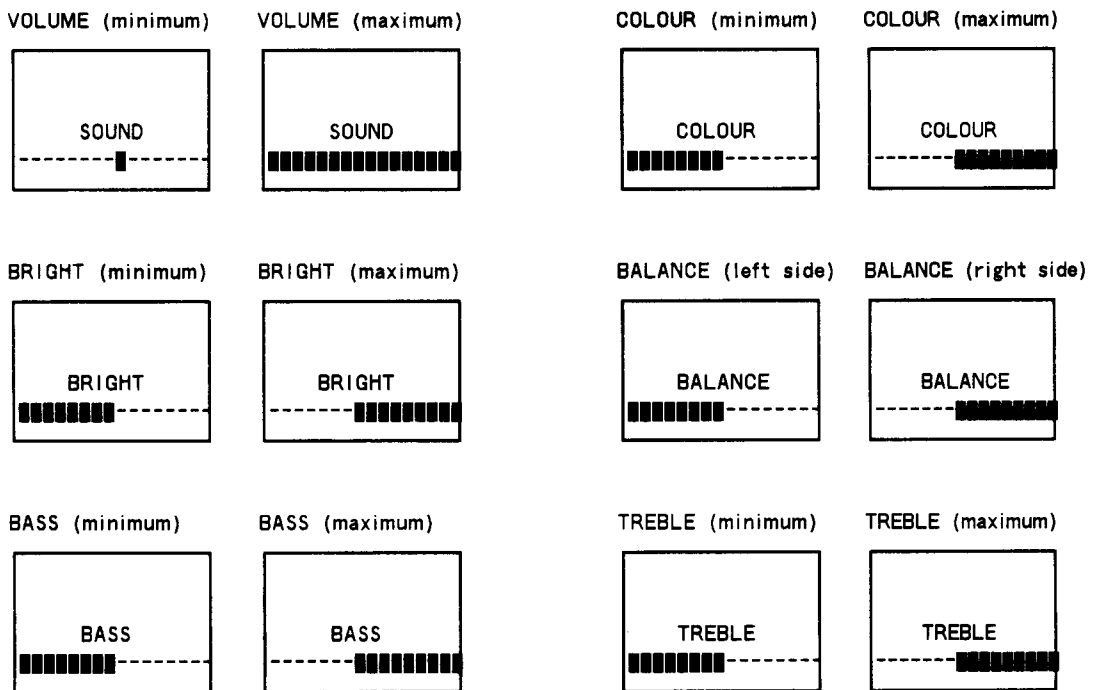



**NORMALIZATION** 

Brightness, colour, bass and treble are set to the optimum level automatically.

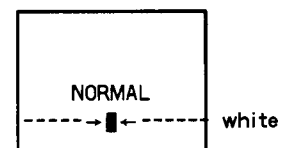
**NORMALIZATION**



**SOUND BALANCE** 

Press the  key to increase sound from the right speaker and press the  key to increase sound from the left speaker. So, press it to the point where the sound volumes of both speakers become identical.

**SOUND WIDE**

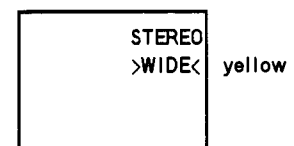

**STEREO WIDE** 

If this key is pressed, a more ambient stereo sound is heard, and ">WIDE<" is displayed on the screen. Press again to normal position.

### MONO / STEREO ▽

When receiving stereo sound, the stereo indicator illuminates. If this key is pressed, monaural sound is heard, and stereo indicator goes out. Press again to stereo sound.

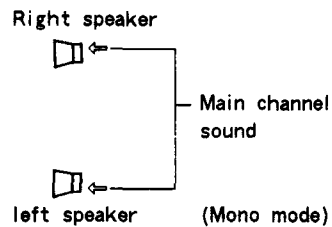
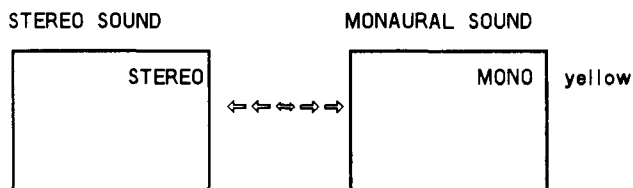

### BILINGUAL I/II

When receiving bilingual sound, the stereo indicator illuminates. If this key is pressed, the main or the sub sound is heard, and the selected sound (I or II) is displayed on the screen by green colour.

### BILINGUAL SOUND

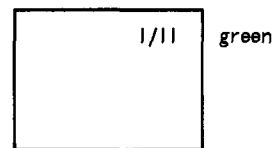

### DIRECT PROGRAMME SELECTION ( The 0~29 programme ) -/--

For selection of programme position 0-9, press the corresponding button. If the required programme is more than 10, for example 23, first press "-/--" button and enter 2, then 3.

### CHANNEL SELECTION ( The 01~99 channel ) CS

Press the "CS" button once to switch channel selection operation. Using the 0 to 9 selection buttons, select the channel number of the desired TV station. Example 45, first press "CS" button, enter 4, then 5.

### FINE TUNING < >

You can adjust the fine tuning by pressing the fine tuning button on the R/C transmitter.

### OFF TIMER ●

Press the off timer button on the R/C transmitter, "-00 ~ -120" number is indicated on the top left of the screen. Repeated pressing of the button changes the number in 30 minutes steps. For example, "-90" means that TV is switched off after 90 minutes. Just one minute before switching off, "-01" and programme number you are watching, are displayed on the screen.

### OFF TIMER

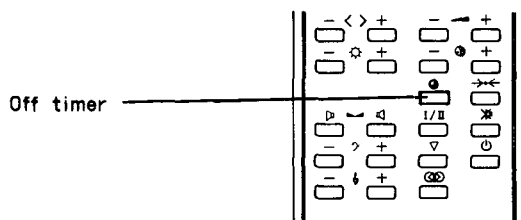
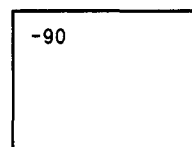

Note: This TV set incorporates the sleep timer function, which automatically switches off the TV set and switches it to the stand-by mode about 10 minutes after a TV broadcast finishes or there is no longer a TV signal. Thereafter, the TV set will not switch on even if a TV signal is input. To switch the TV set on, use the main switch or the remote control transmitter.

# TELETEXT use

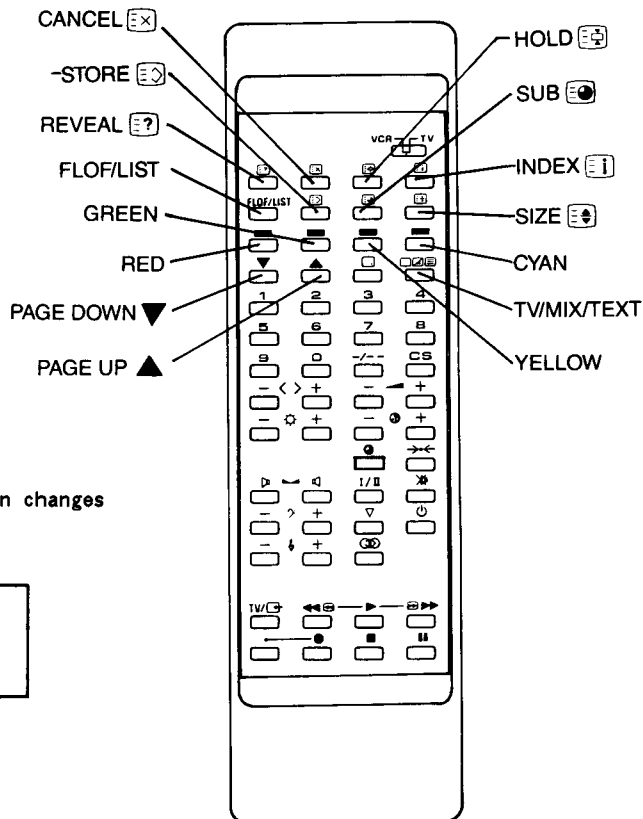

## SWITCHING TO THE TELETEXT PAGE.

Press the TV/MIX/TEXT button, then the screen changes as follows:

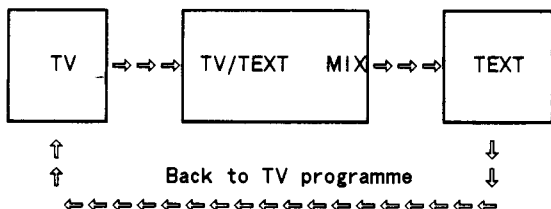

## Page selection

### DIRECT PAGE ACCESS

A page can be selected with the 0-9 buttons. For example, to display page 120 press buttons 1, 2 and 0. The selected page number will appear on the screen.

### UP-DOWN PAGE ACCESS

If a page is displayed on the screen and you want to read the following page, you can press the UP button instead of selecting the page number. To bring back the previous page press the DOWN button. If you keep the UP or DOWN button pressed the page numbers will run up or down until you release the button.

The page number will change as follows by pressing the UP-DOWN button.

(+) P200⇒P201⇒P202 .... P299⇒P200⇒P201

(-) P200⇒P299⇒P298 .... P201⇒P200⇒P299

Note: In the FLOF/LIST mode, you can access the pages directly. (See FLOF/LIST on page 9)

## Sub-coded page access

For Teletext information which is longer than one page, it may take some time for the automatic changing of sub pages to reach the sub page you require. It is possible, however, to enter the sub-page you require and then continue watching the normal television picture until the correct sub-page is reached.

- A. Select the required page using the page selection button.
- B. Press the SUB button. The character "S" and sub code digits "\*\*\*\*\*" will be displayed in top left of the screen.
- C. Enter the desired sub-page number before figure "S\*\*\*\*\*" disappears. For example, if you want to select sub-page 10, you must press 0, 0, 1 and 0 button.  
Then the character "+" is displayed following the page number.
- D. Press the CANCEL to return to normal television programme. When the correct sub-page is reached the page number will appear on the normal television picture.
- E. Press the TEXT button to display the stored page.
- F. To clear the sub-coded page you must enter a new page number.

Note: It is not possible to select another television station during a sub-page access operation.



**VIEWING TV WHILE SEARCHING FOR A PAGE**

In some cases it can take some time to look for a page. In the interval you can view TV by pressing the CANCEL button. When the page arrives, the page number will appear on the normal TV picture. Press TEXT button to display the page.

Note: When you press the CANCEL button, the green " > " mark is displayed at the top right of the screen. While this " > " mark is displayed you can not select another TV channel.

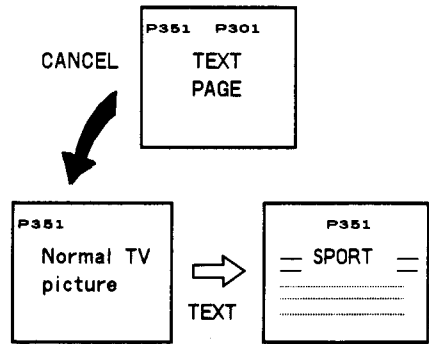

**HOLD**

If the teletext information is longer than one page, the pages are automatically changed. The automatic page changing can be cancelled by pressing the HOLD button. The word "HOLD" then appears on the top of the screen. Normal operation is restored by pressing the HOLD button again or entering a page number.



**DOUBLE LETTER HEIGHT**

Either the top or bottom half of the display can be expanded by pressing the SIZE button. When the SIZE button is pressed for the first time, the top half of the display is expanded. If it is pressed once again, the bottom half of the display is expanded. To return the display to normal-sized characters, this button should be pressed a third time.

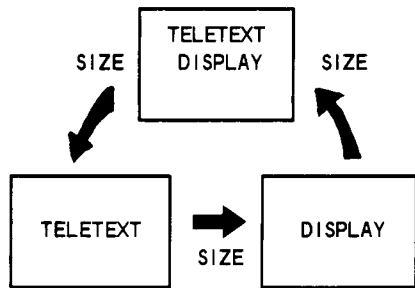

**DISPLAYING CONCEALED INFORMATION**

In one of the lists of contents you may find the heading "QUIZ" (concealed information). If you have selected the relevant page number questions will appear on the screen. You can find out the correct answer to the questions by pressing the REVEAL button. Press the REVEAL button again to make the answers disappear.

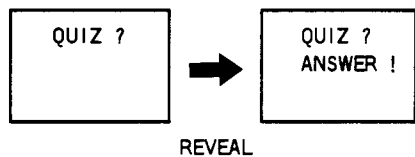

**ALARM CLOCK**

The Alarm Clock function can be set to operate at any requested time reminding viewers to carry out a specific task, i.e. making a phone call at a specified time.

First select either page 196(BBC1) or page 296(BBC2), using the page selection buttons. Press the SUB button, S \*\*\*\* will appear on the top of the screen. Select the time at which you require the alarm call. Example, for a call at 8.15 PM, press buttons 2015, watching that S \*\*\*\* changes to S20:15. Then press the CANCEL button to continue watching normal TV programmes. At 8:15 PM the words "ALARM CLOCK" in large letters will appear on the screen. Press the TEXT button to return to normal teletext operation. It is not possible to select another TV programme when in the CANCEL mode.

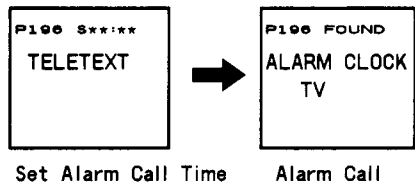

**NEWS FLASH**

If you select the news flash page and view the TV programme by pressing the CANCEL button, the moment news comes in, the word "NEWS FLASH" and the news appears over the normal TV picture. If you want to make the news disappear press the CANCEL button again. To recall the news press the TEXT button.

Note: It is not possible to select another TV station during a NEWS FLASH. You should first switch back to TV reception by pressing the TV button. You can, however, change both the picture and sound settings.

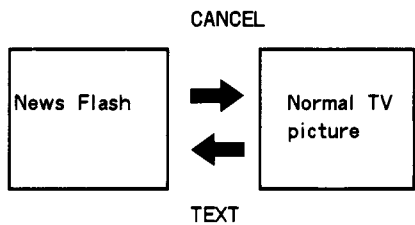

**UPDATED PAGES**

There are pages which are updated as events progress, such as sports results, news reports and traffic information. If you have selected one of the above pages from the list of contents and you want to view television but still be kept informed about the other events, press the CANCEL button. The page will disappear and the TV station which will broadcast this will appear in the screen. As soon as this page is updated, the page number will appear on the normal TV picture. To display the updated page on the screen press the TEXT button. The page will disappear when the CANCEL button is pressed again.

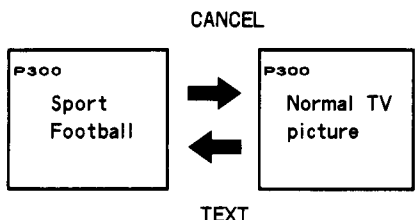

Note: It is not possible to select another TV station during an UPDATE. You should first switch back to TV reception by pressing the TV button. You can, however, change both the picture and sound settings.

FLOF AND LIST ( FLOF: Full level one feature )

When a broadcasting station provides FLOF service, you can access the text pages you desire quickly and easily.

FLOF

In the text mode, FLOF mode can be selected by pressing FLOF/LIST button.

Then the index page which the broadcasting station provides, appears on the screen. At the bottom of the screen, red, green, yellow and cyan letters and " F " letters are indicated.

You can select a programme out of four programmes, by pressing one of the coloured buttons on the R/C transmitter.

For example, when pressing red, the red colour programme is selected. In the same way, you can select the programme which is indicated at the bottom of the screen by pressing the colour button.

To get back to the initial index page, press the "INDEX" button.

LIST

In the LIST mode, the four coloured page numbers and " L " letter are indicated on the bottom of the screen. The number on the left side is enclosed by a red frame. First, input the page number you desire, into each coloured position using the digit buttons, then press the "STORE" button within two seconds.

When the page number is memorized, the four coloured numbers change into white frame momentarily.

After you memorize the four page numbers, you can select the page you desire by pressing the red, green, yellow or cyan button. Even if you select another page by inputting a new page number, ( See direct page selection ), the memorized pages return after switching power off or changing the programme position or pressing the INDEX button.

NON FLOF SERVICE

When the station does not have FLOF service, and you press the FLOF mode button, the INDEX page ( P100 ) is automatically displayed. At the bottom of the screen, the four page numbers 100, 199, 101, 102 are also displayed.

Then, when you select a random page number out of the displayed four pages by pressing a colour button, the text of that page is displayed. The selected page minus one, plus one, and plus two page numbers are displayed but their display order is at random. Of course at any time you can select new pages by inputting new page numbers.

MEMORY OF THE TEXT PAGES

When you assign a broadcasting station which is providing a TEXT service to some programme positions of your TV set, four pages of TEXT can be memorized on each programme position 0~15.

( To memorize the TEXT pages, see " LIST mode " ) If it is required to have more than four instant text pages available from the same text service, tune the necessary number of programme positions to the same TV channel.

- i.e. TV programme position 0.... page,300,301,302,303
- 1.... page,304,305,306,307
- 2.... page,308,309,310,311
- .....
- 15... page,411,412,413,414

The memory capacity is 16 programme positions and four pages per each position.

FLOF mode

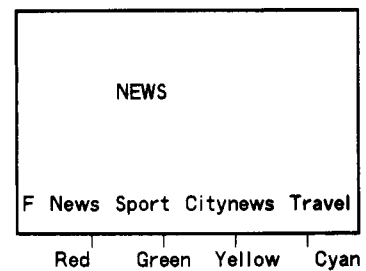
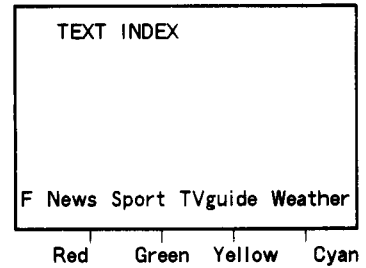

LIST mode

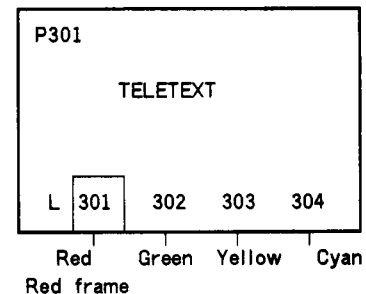

## VCR use

For VCR use set the TV/VCR switch to "VCR" position.

### STOP BUTTON

Use to stop the movement of the tape.

### PLAY BUTTON

Use to playback the tape.

### FF/CUE

Use to advance the tape at fast speed, or in order to playback the tape at fast speed.

### REW/REVIEW

Use to rewind the tape, or in order to playback the tape in reverse at fast speed.

### RECORD

Use to record on the tape. Press two buttons at the same time.

### PAUSE/STILL

Use to temporarily stop (Pause) the tape when recording, or in order to see a still image during playback.

### PROGRAMME UP DOWN +/-

Use to change the programming position for the VCR.

Note: This remote control transmitter has been designed especially to be used in conjunction with selected SANYO VCR's. Some SANYO VCR's may have their own functions, so please refer to the individual instruction booklet when using this remote control with SANYO VCR's to ensure compatibility.

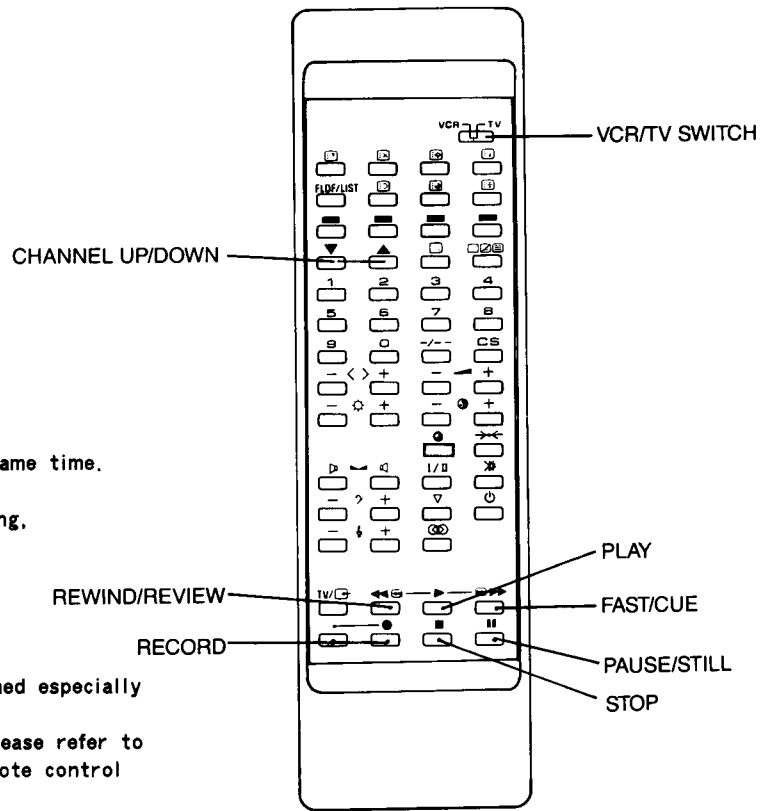

## Audio terminal

More powerful sound can be enjoyed by using your audio apparatus. Connect the audio signal source from audio-monitor-out terminal to the line-in or aux terminal of the audio apparatus.

Next, adjust the volume control on the audio apparatus to your desired volume level. ( The sound is not affected by the volume control on the TV, therefore set to a minimum volume level ).

## External speaker connection

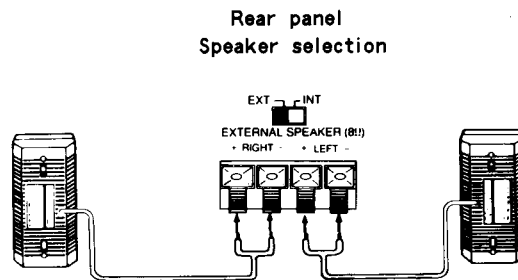

Note: In this case, set "Speaker selection" switch to the "EXT" position. Connect R/L speaker to R/L terminal respectively.

# 21 pin terminal

A personal computer, VCR, video disc player or other AV equipment can be connected to the 21-pin socket on the rear of the TV set.

- The connector ( CENELEC standard 21-pin type ) should be wired as illustrated below.
- The 21-pin plug with cable is obtainable from your local dealer.
- For this connection and adjustment, refer to the operating instructions for the personal computer etc.

## CONNECTION

The specification of the 21-pin connector is as follows:

| Pin No.                         | Signal                |
|---------------------------------|-----------------------|
| 1. Audio output (right channel) | 0.5Vrms/under 1K ohm  |
| 2. Audio input (right channel)  | 0.5Vrms/upper 10k ohm |
| 3. Audio output (left channel)  | 0.5Vrms/under 1k ohm  |
| 4. Earth (audio)                |                       |
| 5. Earth (blue)                 |                       |
| 6. Audio input (left channel)   | 0.5Vrms/upper 10k ohm |
| 7. Blue (B) input               | 0.7Vp-p/75 ohm        |
| 8. Function switching (TV/EXT.) | L: 0~2V, H: 10~12V    |
| 9. Earth (green)                |                       |
| 10.                             |                       |
| 11. Green (G) input             | 0.7Vp-p/75 ohm        |
| 12.                             |                       |
| 13. Earth (red)                 |                       |
| 14. Earth                       |                       |
| 15. Red (R) input               | 0.7Vp-p/75 ohm        |
| 16. Fast blanking               | L: 0~0.4V, H: 1~3V    |
| 17. Earth (video)               |                       |
| 18. Earth                       |                       |
| 19. Video sync. output          | 1Vp-p/75 ohm          |
| 20. Video sync. input           | 1Vp-p/75 ohm          |
| 21. Earth (case)                |                       |

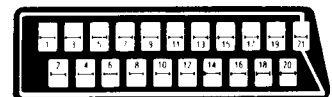

## USE OF THE 21-PIN TERMINAL

If the 21-pin terminal is used for connection of video equipment, audio equipment or a personal computer, note the following points.

### A. Use of video equipment

For playback of VCR tapes or video disc, use equipment which has a pin-8 input function signal.

When equipment which has this function signal is used, the TV set is automatically switched to the video mode, and the remote-control unit cannot be used for TV/VIDEO switching.

For VCR recording, the existence or not of the function signal has no effect. When the equipment which does not have this function signal is used, TV set should be switched to AV mode by pressing TV/AV button.

### B. Use of the personal computer

The personal computer must be the type which has a pin-8 function signal and a pin-16 fast signal (TV/RGB switching). A personal computer which does not have these two signals cannot be used. If the personal computer has RF output terminal, it can be used making the connection to the aerial terminal.

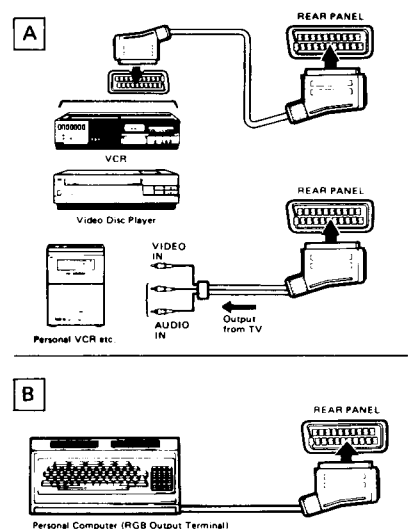

## S-VHS VCR connections

S-VHS VCR is designed with a highly advanced techniques. So the visual quality of S-VHS VCR is better than the other popular VHS VCR. S-VHS VCR can be enjoyed by using S-terminal.

### Example of S-VHS VCR connection

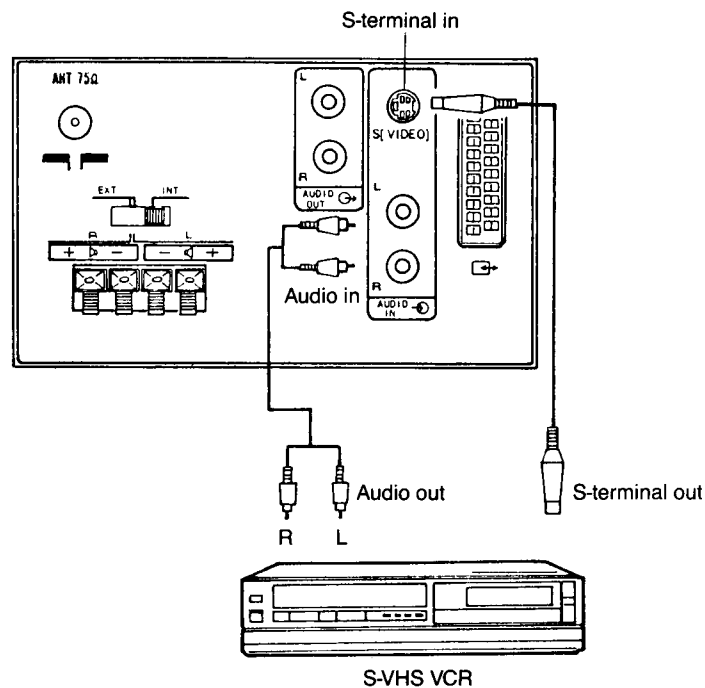

### Input terminals

In order to watch the playback from the S-VHS VCR, the output terminal of the VCR in use must be connected to the S-terminal in and Audio-in terminals and then select the video mode with TV/AV key.

If the audio signal from the VCR is stereo, be sure to connect the right and left channels to the respective right and left Audio-in terminals. If the external audio signal is a monaural one, connect it to the right or left terminal of Audio-in. Then select the monaural mode and the audio channel in the TV set with the remote control mono/stereo and I/II key.

Prior to connecting the S-VHS VCR, be sure to carefully read the instruction booklet of the equipment involved.

Part No.3P10198 D8YV

**SANYO**

---

SANYO Electric Co., Ltd.