

# SANYO

---

**Instruction  
Manual**

**Colour  
Television**

**Model CZP2510  
CZP2510TX  
CZP2910  
CZP2910TX**

**STEREO (NICAM)  
SURROUND  
TELETEXT\*  
S-TERMINAL**

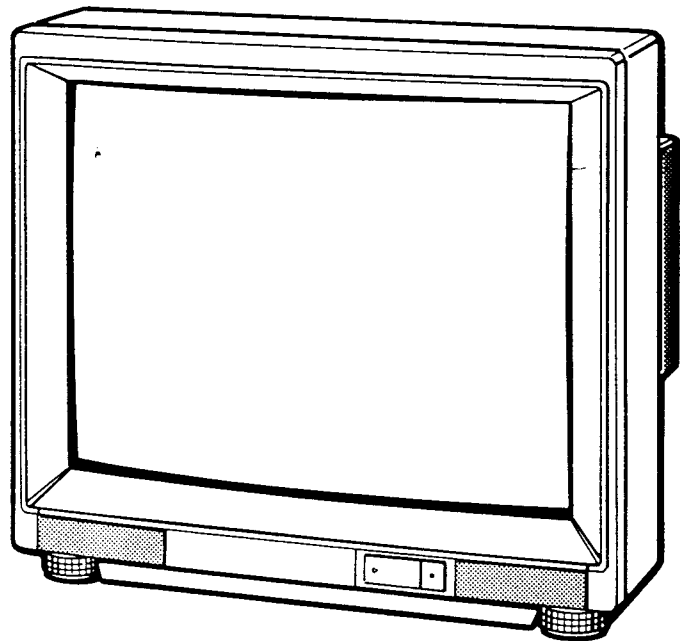

\* Model CZP2510/CZP2910 — Not equipped with the Teletext Decoder.  
Optional Teletext Decoder Type No. TX-231.

## Introduction

### ■ Hi-Fi Stereo Sound Circuit with Surround Circuit.

It's easy to enjoy TV and video sound with the Surround effect.

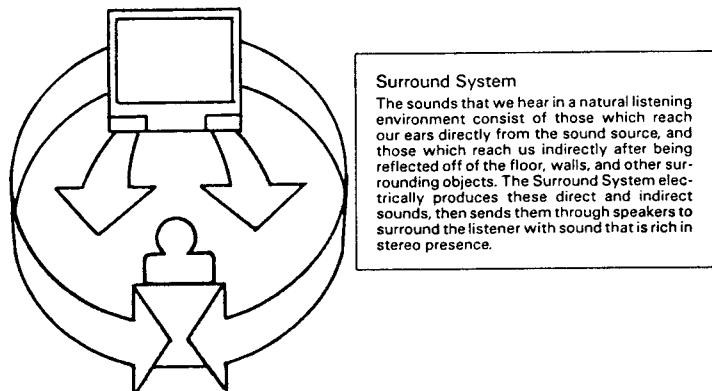

#### Where to Place the TV for the best Surround Effect

- Do not place furniture or other objects any closer than 30 cm from the sides of the TV. Placing objects directly next to the sides of the TV will block the sound from the speakers.
- It is a good idea to place the TV in a corner of the room. This allows the walls to serve as reflectors to achieve a greater Surround effect.

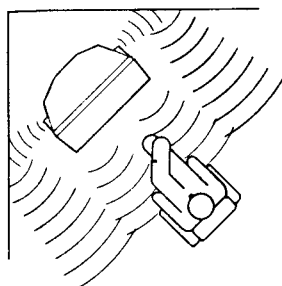

### ■ This AV Television Allows Free System Expansion

- S-terminal is provided.
- CENELEC standard 21-pin terminals is provided.
- Two video/audio inputs and one audio output enable easy VTR connection for tape playback and editing.

### ■ Choose From Two Viewing Angles (Model CZP2910/CZP2910TX only)

Place the TV as it is for a 1.5° slant.

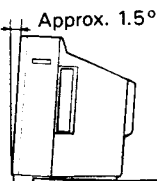

Approx. 1.5°

Or extend the rear adjusters to make the screen perpendicular.

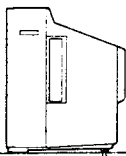

Using the Adjusters

To extend

① Pull



② While pulling, turn until the adjuster stops (about 60°).

To contract



Pull and turn.

Be careful not to over-adjust and cause the TV to tip over forward.

## Electric Mains

The TV receiver is manufactured to utilize an AC VOLTAGE SOURCE of 230 Volts, 50Hz.

Range of operation: 170V (min.) – 280V (max.)

### Safety Precaution

When the TV receiver is not to be used for an extended period of time, it is advisable to disconnect the AC power cord from the AC outlet.

## WARNING

To prevent fire or shock hazard, do not expose the unit to rain or moisture.

High voltages are used in the operation of this TV set.

Do not remove the back from your set. Refer servicing to qualified service personnel.

## Aerial Connection

- Connect the cable with a plug from a UHF (or VHF) aerial to the T1 aerial socket on the cabinet back.

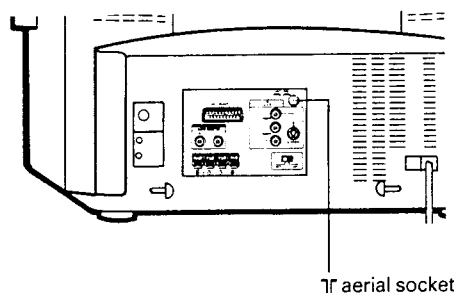

- For all aerial circuit problems please consult your local dealer.

## Controls

Opening the Control Door  
Press the triangular mark to open.

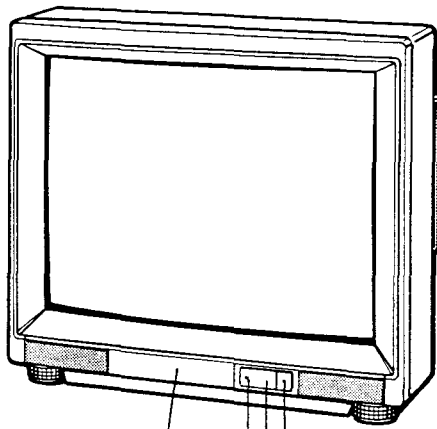
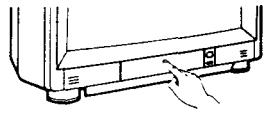

- ① Mains ON/OFF Switch
- Remote Control Detector
- Standby and Power Indicator

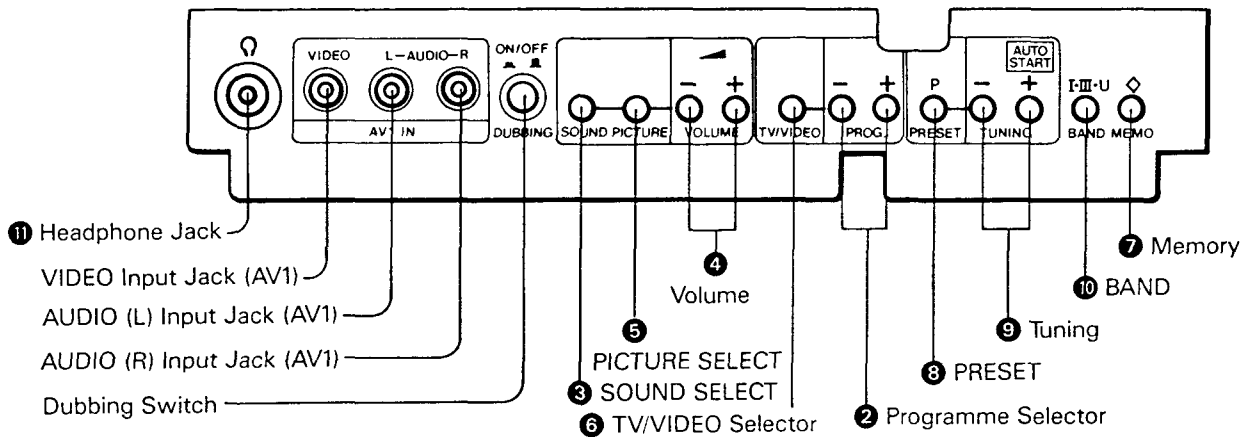

## Operation of the Receiver

### Switching on/off

#### • To turn on the TV:

Press Mains ON/OFF switch ①.

#### • To turn off the TV:

Press the Power ON/OFF button ①-① on the remote control transmitter, and the TV changes to the standby mode. During the standby mode, the standby and power indicator illuminates more brightly than during the power-ON mode.

Press this button ①-① to turn off the unit for short periods of the time.

#### • To turn on the TV from the standby mode:

Press one of these button.

- Power ON/OFF ①-① (Remote control transmitter)
- Programme Selector ②-① (Remote control transmitter)
- Volume ④

#### • To cut off the mains power completely:

Press the Mains ON/OFF switch ①.

**Important!** Be sure to set the Mains ON/OFF switch ① to the off position, if the power failure occurs while viewing.

#### • AUTO SHUT OFF

This TV set incorporates the AUTO SHUT OFF function.

Even if the TV is left on after you have gone to sleep, the TV set changes to the standby mode within 10 minutes after all broadcasts have ended.

Note: AUTO SHUT OFF also functions for the AV mode even when there is no signal being transmitted.

The remaining time for AUTO SHUT OFF is displayed on the screen.

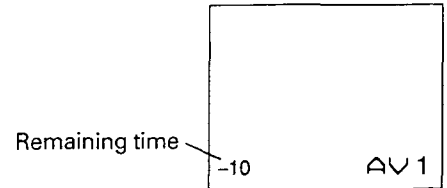

#### Programme selection

Press the right side (+) of the programme selector ② of the TV set, and the TV set will step up to the next station, i.e; 1, 2, 3 ... 29, VCR1, VCR2, VCR3, 1, 2, 3 ...

Press the left side (-), and the TV set will step down to the previous station.

# (Operation of the Receiver)

## Sound adjustments

- To adjust the sound volume:  
Press + or - volume **4** button.

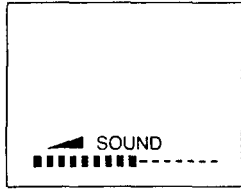

- To adjust the bass, treble, balance and the depth of surround effect:

- Select the control function by pressing SOUND SELECT **3** button.

- Each time SOUND SELECT **3** button is pressed, the control function changes as follows:

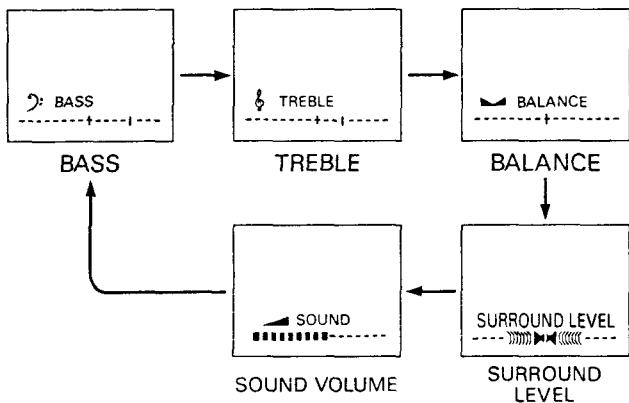

Note: "SURROUND LEVEL" will be skipped when the Surround effect is turned off.

- Adjust the bass, treble, balance or the depth of surround effect by pressing Volume **4** button.

## Picture adjustments

- Select the picture control function by pressing PICTURE SELECT **5** button.

- Each time PICTURE SELECT **5** button is pressed, the control function changes as follows:

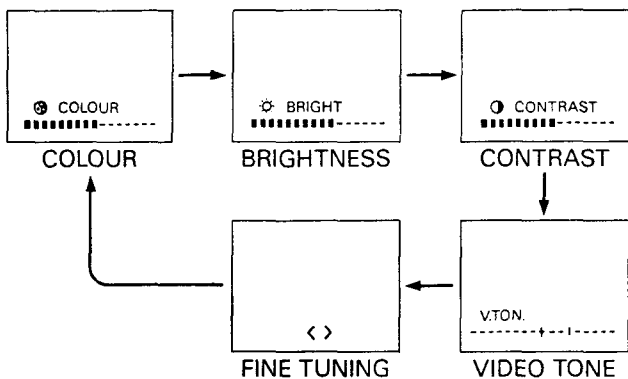

- Adjust the colour intensity, brightness, contrast video tone or fine tuning by pressing Volume **4** button.

## 6... TV/VIDEO Selector

To watch the television programmes leave this switch in the TV mode. When this switch is set to the VIDEO mode you can enjoy the playback from the VCR or other AV equipment connected to the AV input terminals.

Each time the TV/VIDEO Selector **6** is pressed, the AV position changes as follows:

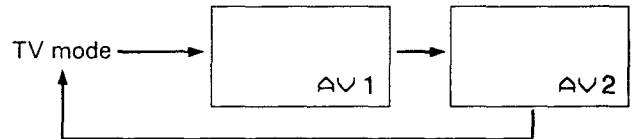

\*In the AV mode, you can select the TV programme.

- For example, to select the programme position "7" in the AV mode (while watching the playback from a VTR):

- Press "7" button of the programme selector **2-1**.

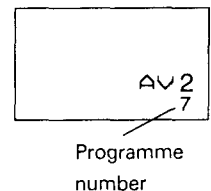

- Press TV/VIDEO Selector **6**, and the picture of the programme position "7" will appear.



## 7... Memory

This function lets you store the settings (for colour, brightness, contrast, video tone, sound volume, bass, treble, balance and Surround effect) in memory for both picture and the sound. Simply adjust the picture and sound as desired, then press the Memory **7** button. To recall these levels from memory, press the Normalization **16** button on the remote control unit.

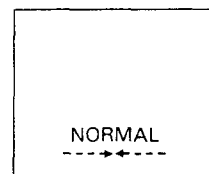

When Memory button is pressed, "NORMAL" is displayed.

## 11... Headphone Jack

Insert the headphones plug into this jack to listen to either stereo or monaural sound via a headphones set.

Note: No sound will be heard from the speakers when the headphones plug is connected to this jack.



# (Remote Control Operation)

## • Fine tuning

Press < > (Fine tuning) button.

Press ▲ or ▼ volume button.

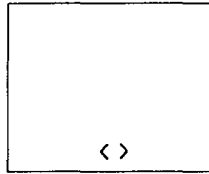

**Note:** Normally fine tuning is not required for this TV. However, in some case (such as radio interference) picture may become more clear by detuning from the best tuned frequency.

In such case, you can use this fine tuning to eliminate some interference beat pattern.

## Sound adjustments

### • To adjust the sound volume:

Press ▲ (up) or ▼ (down) volume 4 button.

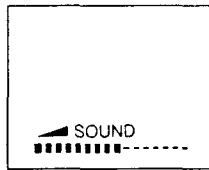

### • To adjust the bass, treble, balance and the depth of surround effect:

1 Select the control function by pressing AUDIO SELECT 3 button.

• Each time AUDIO SELECT 3 button is pressed, the control function changes as follows;

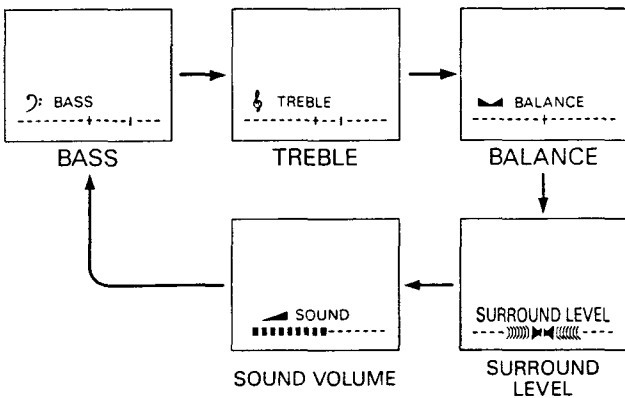

**Note:** "SURROUND LEVEL" will be skipped when the surround effect is turned off.

2 Adjust the bass, treble, balance or the depth of surround effect by pressing Volume 4 button.

## 12 ... Surround ON/OFF

To enjoy the surround effect, press the Surround ON/OFF 12 button.

To cancel the effect, press this button again.

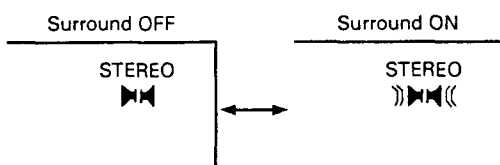

## 13 ... Stereo/Mono ▽

• When receiving the stereo broadcast, STEREO is displayed. If the sound of a stereo broadcast is not clear due to interference or poor reception, select the MONO position by pressing this button.

• In the AV mode, select either STEREO or MONO to match the stereo or monaural condition of the audio signal coming from an external source, e.g. a VCR, A. V. equipment, or other component by pressing Stereo/Mono Switch.

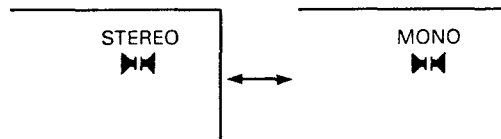

## 14 ... Bilingual A/B

When receiving the bilingual broadcast, MAIN (A) is displayed.

You can select the main or sub language with this button.

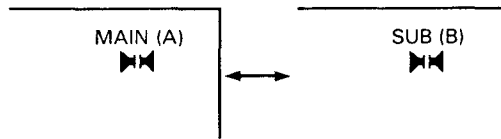

If the sound of a bilingual broadcast is not clear due to interference or poor reception, select the MONO position by pressing Stereo/Mono ▽ 13 button.

In the AV mode, each time Bilingual A/B button is pressed, the audio channel changes as follows:

LEFT (A) ↔ RIGHT (B)

## 15 ... Sound mute ✕

Should you wish to mute the sound (e.g. While talking on the telephone), press this button once. To switch the sound back on, press it again.

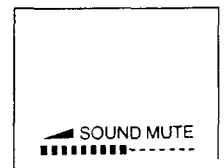

## 16 ... Normalization →←

Press this button to recall the picture and sound settings which you stored using the Memory 7 button.

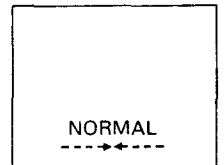

## 17 ... Channel Scanning ↻

Press Channel Scanning button 17 to search for a programme. The channel positions are automatically scanned, and the channel scanning will stop at the position where it began. To stop at the position you want, press this button again.

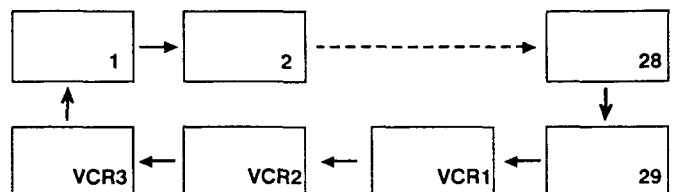

## (Remote Control Operation)

### 18.... Off timer

After a set time has elapsed, the power of the TV receiver is switched off automatically.

- Each time Off timer button  is pressed, the set time changes as follows:

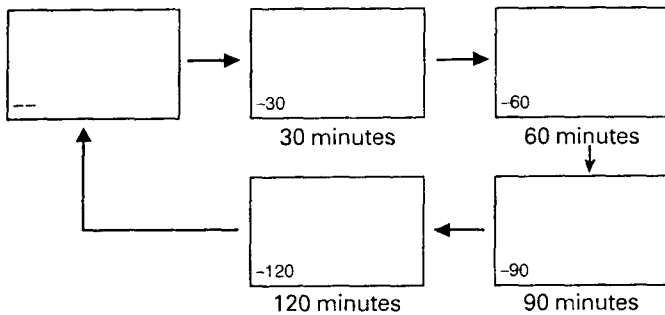

With the off timer being set and the channel display reset, the remaining time is displayed by pressing the off timer button again.

When the button is pressed again within three seconds after the button was first pressed in above manner, the time is set to an upper time which is most close to the remaining time.

- Just one minute before switching off, "-01" and programme number you are watching are displayed on the screen.
- The timer setting will be cancelled if the power is switched off.

### 19.... Recall /S

To display the on-screen indications, press this button.



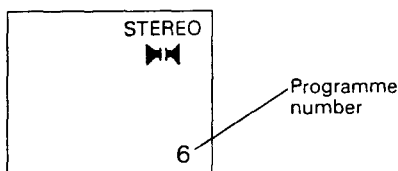



The display disappears after five seconds.

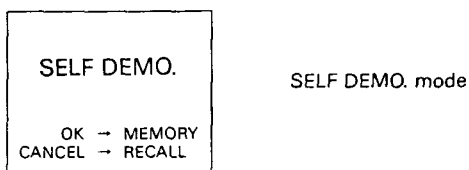

Note: When this button is pressed for more than 2 seconds, The following is displayed and the unit enters SELF DEMO mode. This mode is for use in storefront demonstrations.

It has no effect on TV operation.



- To cancel the SELF DEMO mode, press the Recall  /S  button once again.
- If the Memory   button is pressed in the SELF DEMO mode, the self-demonstration will begin. You can also cancel the SELF DEMO mode midway through play by pressing the Recall  /S  button.

## VCR USE

Note: This remote control transmitter has been designed especially to be used in conjunction with selected SANYO VCR's.

Some SANYO VCR's may have their own functions, so please refer to the individual instruction booklet when using this remote control with SANYO VCR's to ensure compatibility.

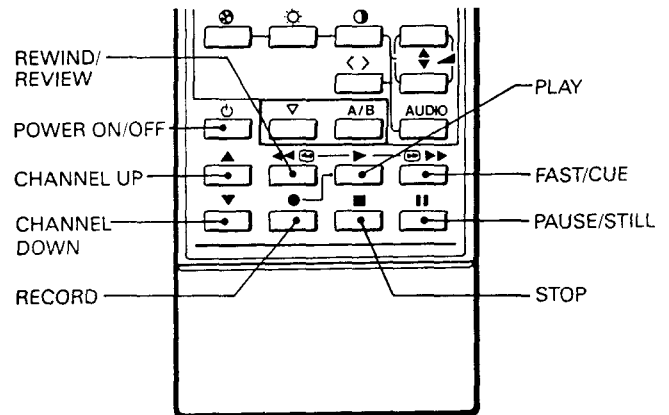

### POWER ON/OFF BUTTON

Use to turn VCR power on and off.

### PLAY BUTTON

Use to playback the tape.

### STOP BUTTON

Use to stop the movement of the tape.

### FAST/CUE

Use to advance the tape at fast speed, or in order to playback the tape at fast speed.

### REWIND/REVIEW

Use to rewind the tape, or in order to playback the tape in reverse at fast speed.

### PAUSE/STILL

Use to temporarily stop (Pause) the tape when recording, or in order to see a still image during playback.

### CH UP DOWN ▲/▼

Use to change the programming position for the VCR.

### RECORD

Use to record on the tape.

Press and hold down the RECORD button, then press the PLAY button.

## Battery Installation (Remote Control Transmitter)

- 1 Remove the battery cover by sliding.
- 2 Install two "AA" 1.5 volt batteries so that the "+" and "-" marks on the batteries match the "+" and "-" marks inside the unit.
- 3 Close the battery cover.

Note: Replace the batteries when the TV set is showing the following symptoms:

Operation is unsteady or erratic, sometimes the TV set does not work with transmitter. Discharged batteries may leak and damage the unit. The normal life of batteries should be from nine to ten months.

# Pre-Setting of Stations

Up to 32 broadcast stations in your reception area can be stored in the electronic memory.

There are two ways of presetting as follows:

## Automatic presetting — the basic way

All receivable channels are automatically tuned in and memorized in consecutive program positions.

Note: Programme position 1 to 29 can be automatically preset. VCR1, VCR2 and VCR3 positions cannot be automatically preset.

## Manual presetting

Use to preset a receivable channel in any desired program position, e.g. the position with the same number as the channel.

### Automatic presetting

1. Select any programme position from 1 to 29.  
(Automatic presetting is not possible from the VCR1, VCR2, or VCR3 position.)

2. Press PRESET (8) button.

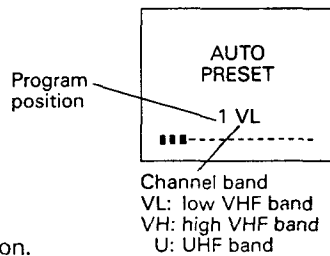
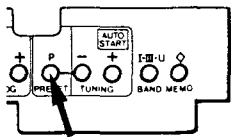

3. Press TUNING (+) (9) button.

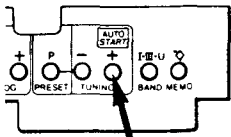

The channels are preset in consecutive positions beginning from the program position "1".

After all available channels (position 1 to 29) have been preset, the unit returns to the position "1".

Note: To cancel automatic presetting midway, press the Recall (19) button.

### Manual presetting

1. Press PRESET (8) button.

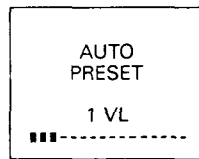
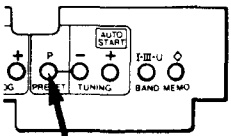

2. Press PRESET (8) button again.

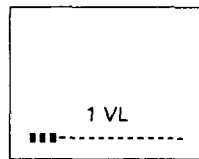
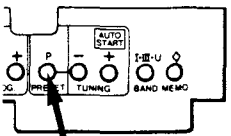

3. Press the programme selector (2) or (2-1) to select the desired programme position.

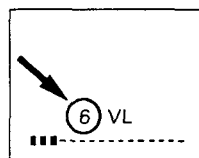
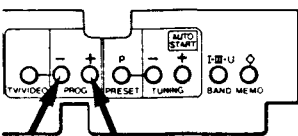

4. Press BAND selector (10) to select the channel band.

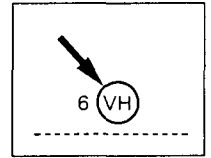
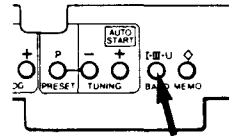

When BAND selector is pressed, the frequency will be set to the lowest frequency in the set band.

• Channels band VL, VH and U are for the following channel groups.

Band I	VHF Low Channels	1-3
Band III	VHF High Channels	4-11
Band U	UHF Channels	21-69

5. Press and hold Tuning (9) (+) or (-) button until the desired station appears.

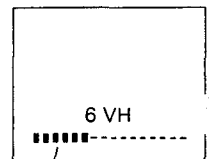
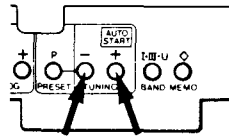

The number of upright segments increases for a higher-frequency channel.

6. Press (Memory) button (7).

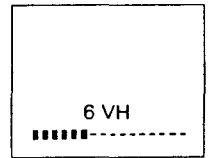
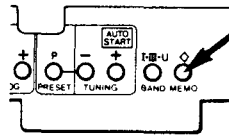

7. Repeat steps 3 to 6 for other desired channels.

8. Press PRESET (8) or (Recall) (19) button.

This completes the presetting.

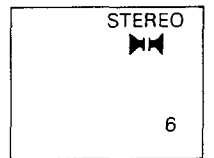
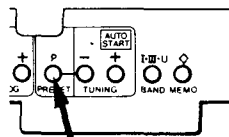

## Memory Copy

This TV tuning system has another advanced feature called "memory copy".

For example, if you wish to copy the TV channel in the programme position "2" into the programme position "6":

1. Select the programme position "2".
2. Press PRESET (8) button.
3. Press PRESET (8) button once again.
4. Press "6" button of the programme selector (2-1).
5. Press (Memory) button (7).
6. Press PRESET (8) or (Recall) (19) button.



# (Pre-Setting of Stations)

## Inserting Channels

The following example shows how to insert Channel-D of programme position "4" into programme position "2".

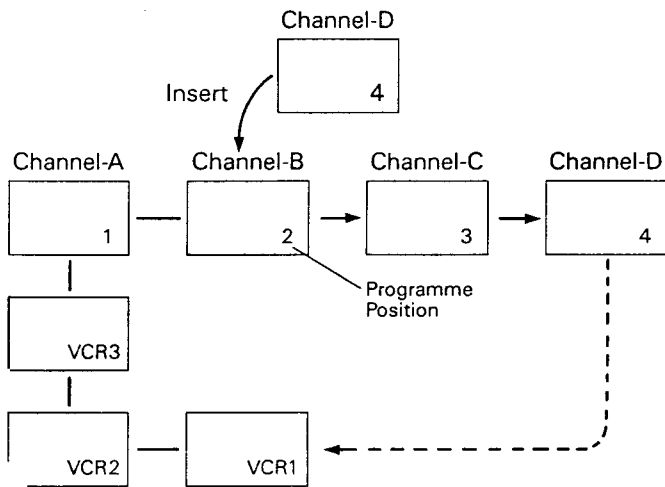

1. Select programme position "4" (Channel-D).
2. Press PRESET **8** button.
3. Press PRESET **8** button once again.
4. Press "2" button of the Programme Selector **2-1**.

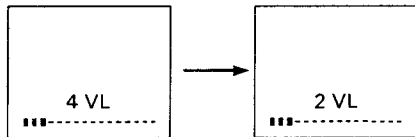

5. Press and hold down the TV/VIDEO selector **6**, then press the (+) Programme Selector **2**.
6. Press the PRESET **8** or Recall **19** button.
  - Channel-D of programme position "4" is now inserted into programme position "2".
  - In this example, the channels from Channel-B (programme position "2") onward will be shifted successively into the next highest programme position.

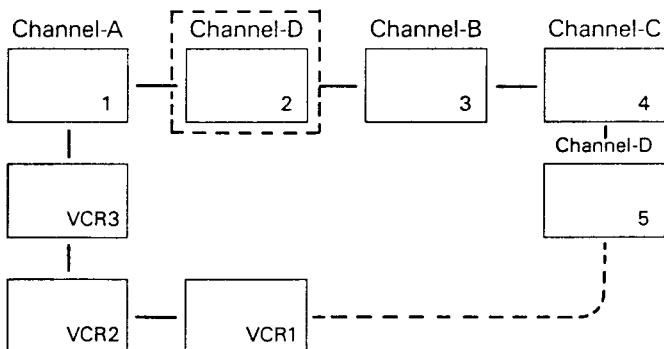

Note: You cannot insert a channel which would cause the channel in programme position "29" to shift to a higher programme position. You also cannot insert channels into the VCR1, VCR2, or VCR3 position. When the above procedure is done, the position indicators will flash in red.

## Deleting Channels

The following example shows how to delete Channel-B from programme position "2".

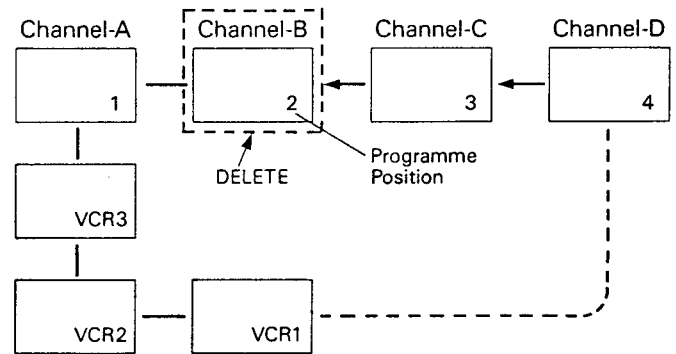

1. Select programme position "2" (Channel-B).
2. Press PRESET **8** button.
3. Press PRESET **8** button once again.

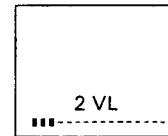

4. Press and hold down the TV/VIDEO selector **6**, then press the (-) Programme Selector **2**.
5. Press PRESET **8** or **19** (Recall) button.
  - Channel-B of programme position "2" is now deleted.
  - In this example, the channels from Channel-B (programme position "2") onward will be shifted successively into the next lowest programme position.

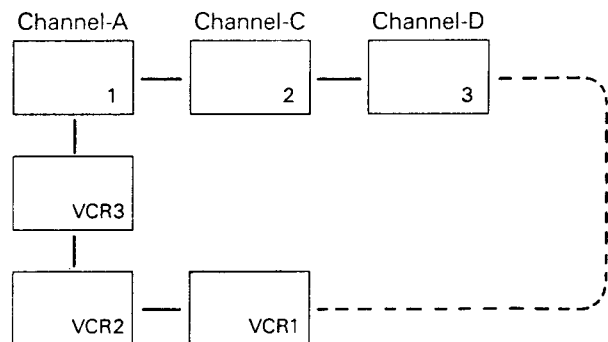

Note: Channel deletion is not possible in the VCR1, VCR2, or VCR3 position.

When the above procedure is done, the position indicator (VCR1, VCR2, or VCR3) will flash in red.

# TELETEXT USE

- Automatically adjust for displays in English, German, Swedish, French and Italian in accordance with the television broadcast signals.

\* Model CZP2510/CZP2910 – Not equipped with the Teletext Decoder.  
(Optional Teletext Decoder Type NO. TX-231.)

It is not necessary to go back to the index page each time; within any one service you can change direct from one page to another. After a new page has been entered, the previous page is displayed until the new page is received. On reception of the new page, the rolling page number stops, showing the requested page number.

Note: If the new page is a NEWSFLASH or SUBTITLE page, the television video is automatically turned on, and the newsflash or subtitle is displayed in a box within the picture. Conversely, if the old page was a newsflash or subtitle page, and new page is not, then the picture is turned off.

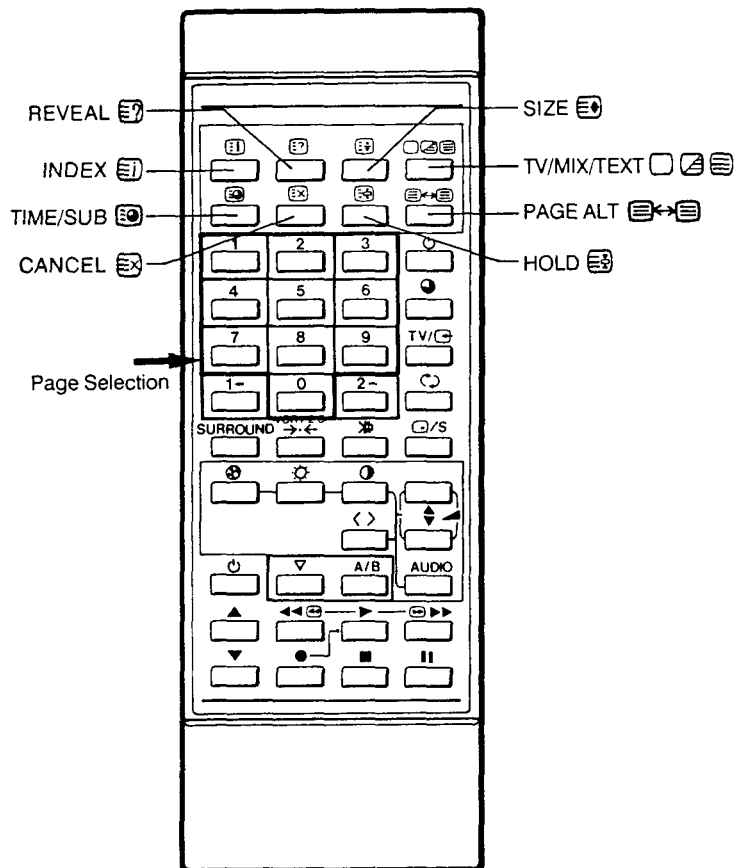

P1 TELETEXT P100 Wed 16 Aug 18:48:22

P15 TELETEXT P100 Wed 16 Aug 18:48:24

P151 TELETEXT P144 Wed 16 Aug 18:48:27

## VIEWING TV WHILE SEARCHING FOR A PAGE

In some cases it can take some time to look for a page. In the interval you can view TV by pressing the CANCEL button. When the page arrives, the page number will appear on the normal TV picture. Press TV/MIX/TEXT button to display the page.

Note: When you press the CANCEL button, the green ">" mark is displayed at the top right of the screen. Whilst this ">" mark is displayed you can not select another TV channel.

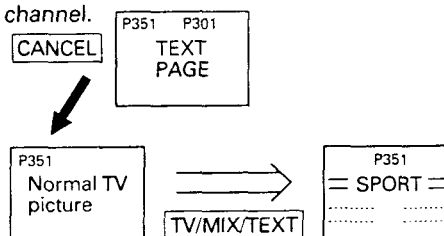

## Switching to the Teletext Mode

Press the TV/MIX/TEXT button, then the screen changes as follows:

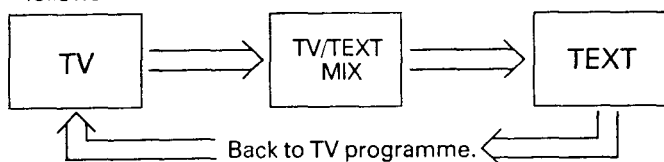

## Page Selection

When teletext mode is first selected, the index page (p. 100) is automatically obtained. The requested page is obtained by simply pressing three number buttons in sequence. For example, if you wish to look at page 151, pressing the number, (1), (5) and (1) in turn.

As each command is accepted, the page number at the left-hand end of the header will be built up, digit by digit, until it is complete.

After the final entry has been registered, rolling page numbers are presented until the requested page is received. As soon as the two groups of numbers coincide, the information contained on page 151 appears.

Other pages of the same service can be obtained in this manner, using the appropriate number.

## Sub-coded page access

For Teletext information which is longer than one page it may take some time for the automatic changing of pages to reach the sub page you require. It is possible, however, to enter the sub-page you require and then continue watching the normal television picture until the correct sub-page is reached.

- Select the required page using the page selection button.
- Press the TIME/SUB button. The sub code digits "----" will be displayed in the top left of the screen.
- Enter the desired sub-page number.  
For example, if you select sub-page 10 you must press 0, 0, 1 and 0 button.
- Press the CANCEL to return to normal television programme.  
When the correct sub-page is reached the page number will appear on the normal television picture.
- Press the TV/MIX/TEXT button to display the stored page.
- To clear the sub-coded page you must enter a new page number, or the TIME/SUB button.

Note: It is not possible to select another television station during a sub-page access operation.

# (TELETEXT USE)

## ■ Page Alternate

Press the Page Alternate  button and the TV set will alternately select the previous page and the present page. For example, now you are watching "page 300" but you watched "page 200" previously. If you press the Page Alternate button, "page 200" appears.

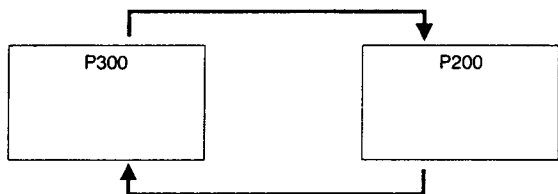

## ■ Updated Pages

There are pages which are updated as events progress, such as sports results, news reports and traffic information. If you have selected one of the above pages from the list of contents and you want to view television but still be kept informed about the other events, press the CANCEL button. The page will disappear and the TV station which will broadcast this will appear in the screen. As soon as this page is updated, the page number will appear on the normal TV picture. To display the updated page on the screen press the TV/MIX/TEXT button. The page will disappear when the CANCEL button is pressed again.

Note: It is not possible to select another TV station during an UPDATE. You should first switch back to TV reception by pressing the TV/MIX/TEXT button. You can, however, change both the picture and sound settings.

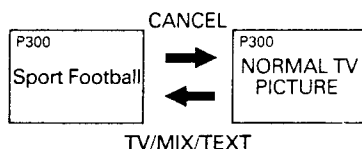

## ■ HOLD

Some pages contain more information than can be displayed on the screen simultaneously and are therefore subdivided into a series of two or more sub-pages. The first sub-page of a series of four sub-pages, for example, has the indication 1/4 displayed at the top right of the screen (below the time).

These sub-pages are 'rotated', that is, each sub-page is displayed for a certain time (determined by the broadcasting authorities) before being replaced by the next sub-page. If it is desired to halt this rotation and retains a particular sub-page, the HOLD button should be pressed. The word HOLD then appear on the top of the screen.

This command stops the reception of teletext data and can be used to prevent the updating of pages whenever required.

Normal operation is restored by pressing the HOLD button again or entering a new page number.

## ■ Large Characters (SIZE)

Normally small characters are used in teletext mode, but in some circumstances the 'doubleheight' facility may be useful; when the viewer is some distance from the receiver, for example. Either the top or bottom half of the display can be expanded by pressing the SIZE button. When this button is pressed for the first time, the top half of the display is expanded. If it is pressed once again, the bottom half of the display is expanded.

To return the display to normal-sized characters, this button should be pressed again.

If television mode is selected while large characters are being displayed, small characters will be displayed when the system is next returned to teletext mode.

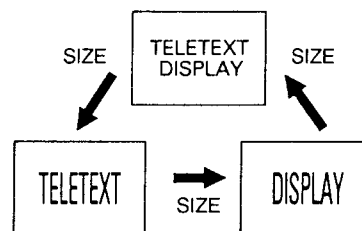

## ■ INDEX

When this button is pressed in teletext mode, several teletext functions are reset: the page memory is cleared, the command Time Page ON (T. PAGE) is cancelled, and the teletext decoder is set up to display the index page (P100).

## ■ REVEAL

Some pages have part of the display concealed: a quiz page with concealed answers, for example. The command REVEAL displays the concealed text as long as REVEAL button remains depressed.

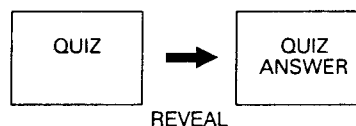

## (TELETEXT USE)

---

### ■ Time Coded Pages (TIME/SUB)

Time coding enables the viewer to put into store a specific page of information ready for viewing at a pre-determined time.

#### IMPORTANT NOTE

With present transmissions this facility is limited to the 'Alarm Clock' pages. Please refer to the transmitted index for the appropriate page number.

The required page is selected in the usual manner and then the command T. PAGE (Time Page On) is entered. The time that the requested page should be received is then entered on the screen using the number keys two digits for hours and two digits for minutes, using the 24 hour clock system. The character 'T' precedes the time digits to indicate that a time code and not the actual code is being displayed, also the four digits flash. After the time code has been entered rolling page numbers are presented. The cancel button is then pressed and the receiver reverts to picture. When the pre-set time is reached the page number will appear in the top left corner of the screen and the data can be seen by pressing cancel again. To clear the time code from the T.V. memory, press TIME/SUB  button again. (Time Page Off).

It is important to remember that once the time coding has been set and the text cancelled pressing any buttons on the handset other than the Brightness, Colour, Volume and Mute may upset the pre-set time.

### ■ TIME

If the time is required while a programme is being viewed press the TIME/SUB  button.

Providing that the channel being viewed is also transmitting teletext, the time will appear at the top righthand of the screen for five seconds. The digits displayed represent hours/minutes/seconds.

18:05:47

# CONNECTING OTHER EQUIPMENT

## ■ Connecting to the AV2 Input Jack

Connect to the video and audio outputs of a VTR, video disc player, etc. Tapes and discs can be played back.

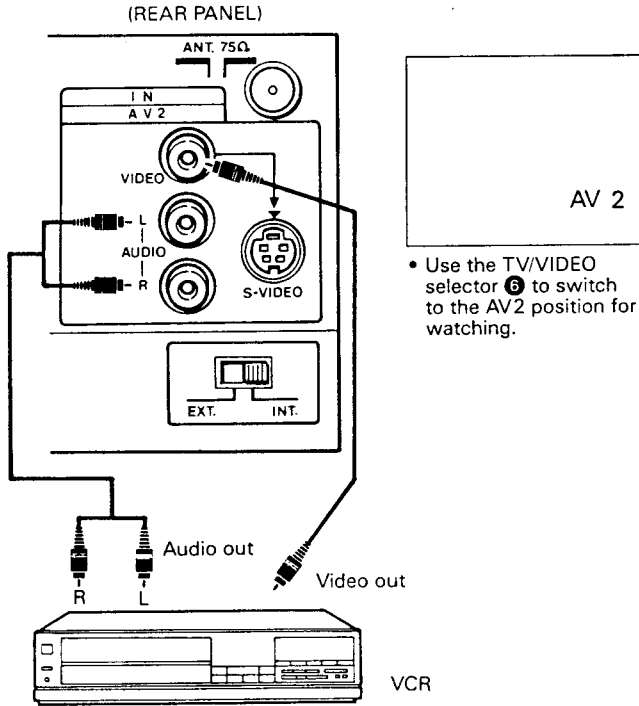

If the audio signal from the VCR is stereo, be sure to connect the right and left channels to the respective right and left Audio-in terminals.

If the external audio signal is a monaural one, connect it to the left terminal of Audio-in. Then select the monaural mode and the audio channel in the TV set with the remote control Stereo/Mono button ⑬ or Bilingual A/B button ⑭.

## ■ S-VHS VCR Connections.

S-VHS VCR is designed with a highly advanced techniques. So the visual quality of S-VHS VCR is better than the other popular VHS VCR.

S-VHS VCR can be enjoyed by using S-terminal.

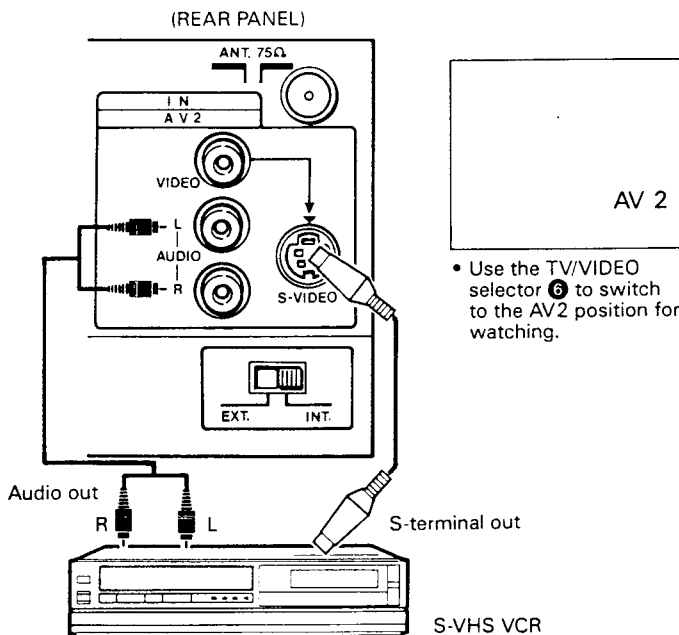

## ■ Audio Monitor Out Connection

More powerful sound can be enjoyed by using your audio apparatus.

Connect the audio signal source from audio-monitor-out terminal to the line-in or aux terminal of the audio apparatus.

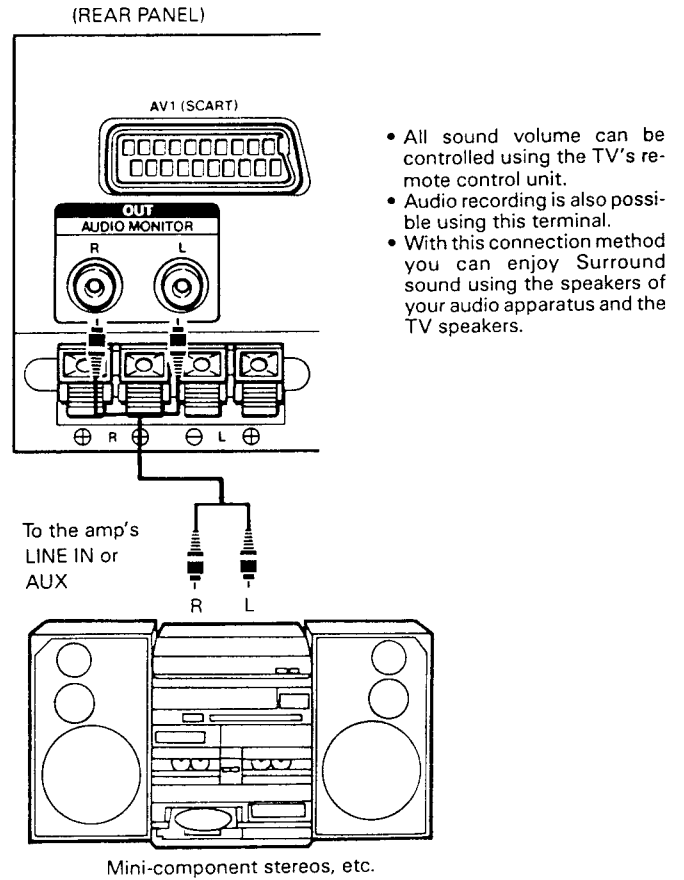

## ■ External Speaker Connection

(REAR PANEL)

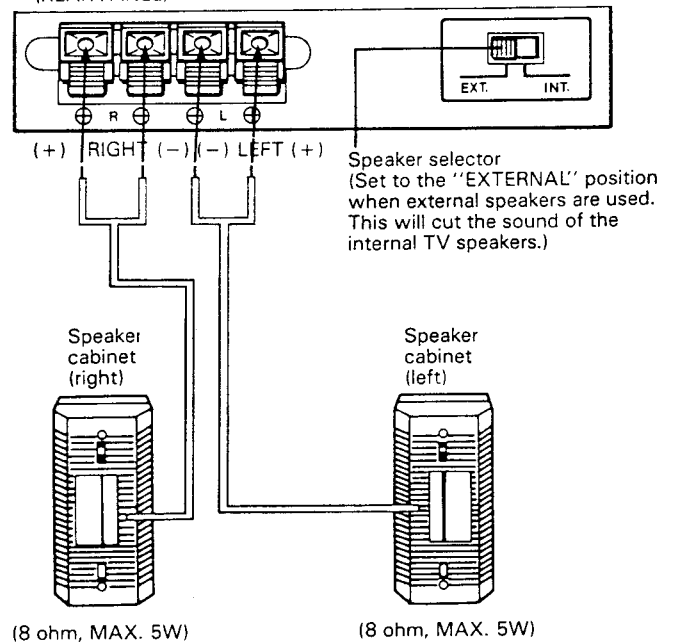

- You can also enjoy Surround sound through connected external speakers.

## (CONNECTING OTHER EQUIPMENT)

### ■ Connecting to the Front Panel AV1 Input Jack

It is convenient to use the AV1 input jack on the front panel for equipment that is often connected and disconnected.

(TV front panel terminals)

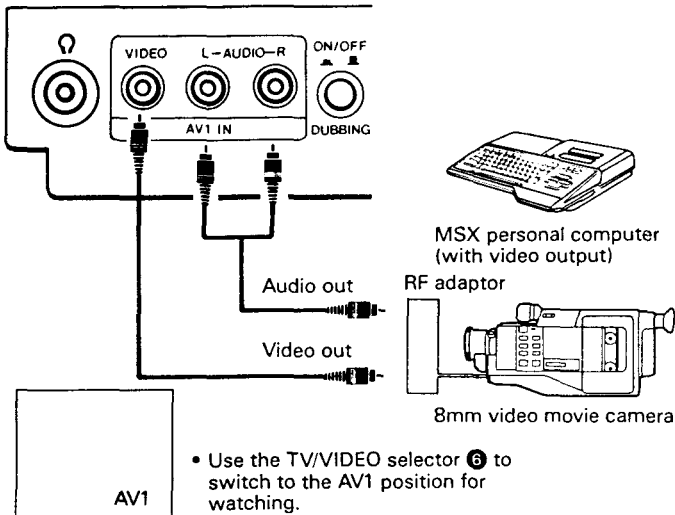

### ■ Video Dubbing

The AV1 input jack on the front panel is bridged with 21-pin terminal on the rear panel, so you can connect two VCRs, one to the front panel and one to the rear panel, and dub tapes while monitoring them on the TV screen.

(TV front panel terminals)

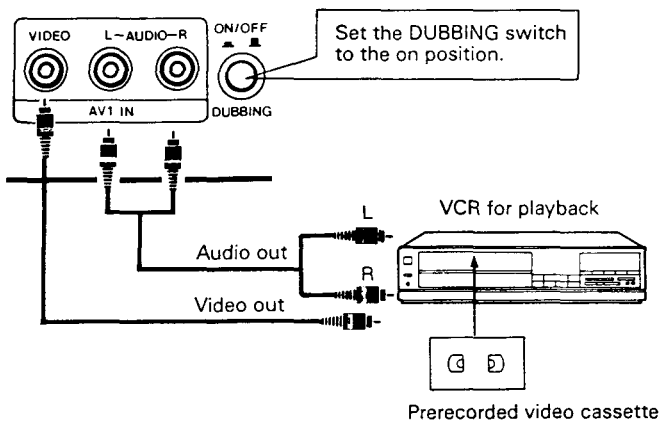

(TV rear panel terminals)

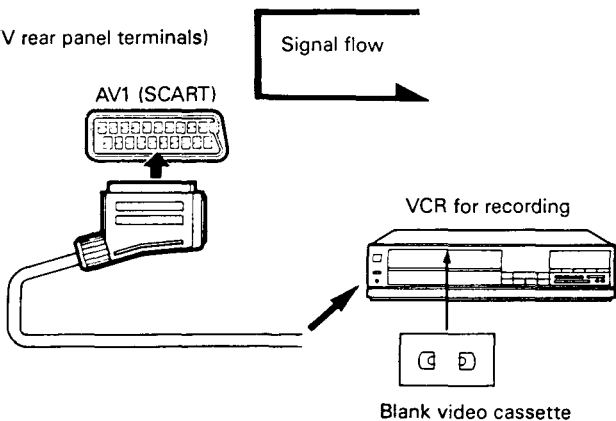

- The image can be monitored on the TV screen as soon as dubbing begins. Use the TV/VIDEO selector **6** to switch to the AV1 position for watching. Adjustments to the TV picture or sound volume will have no effect on the dubbing operation.

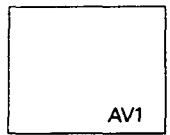

### ■ Use of the 21-pin Terminal

A personal computer, VCR, Video disc player or other AV apparatus can be connected to the 21-pin socket on the rear panel of the TV set.

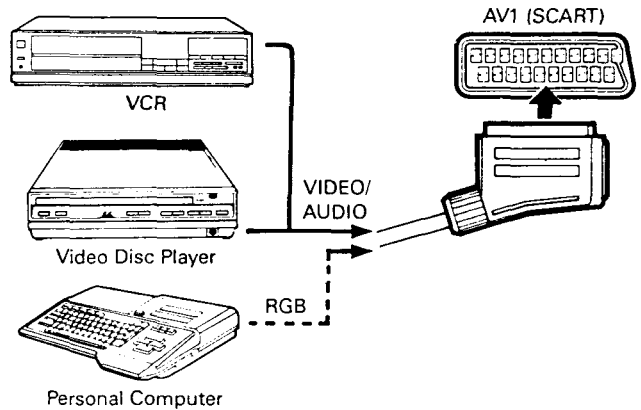

- When the 21-pin terminal is used for connection of video equipment, audio equipment or a personal computer, note the following points.

#### A Use of video equipment

For playback of VCR tapes or video discs, use equipment which has an 8-pin input function signal. When equipment which does not have this function signal is used, press TV/VIDEO Selector **6** to select "AV1" mode.

When equipment which has this function signal is used, the TV set is automatically switched to "AV1" mode, and the remotecontrol transmitter cannot be used for TV/VIDEO switch.

For VCR recording, the presence or absence of the function signal has no effect.

#### B Use of personal computer

The personal computer must be the type which has an 8-pin function signal and a 16-pin fast signal (TV/RGB switching). When using the RGB input signal from a personal computer etc., which is not equipped with the control signals (pin-8 and pin-16), as described below, you must set and select the RGB position for personal computer use.

\*Setting the RGB Position\*

1. Select "VCR3" position.
2. Press and hold Recall  / S **19** button for more than 2 seconds.

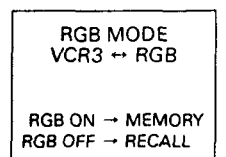
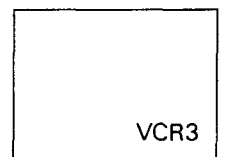

## (CONNECTING OTHER EQUIPMENT)

3. Press Memory  $\diamond$  7 button of the TV set.

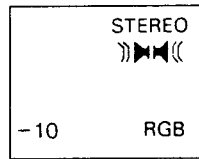

\*Cancelling the RGB Position\*

1. Select "RGB" position.
2. Press and hold Recall  $\square$  /S 19 button for more than 2 seconds.
3. Press Recall  $\square$  /S 19 button once again.

The specification of the 21-pin connector is as follows:

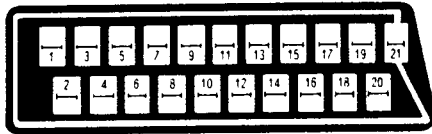

Pin No.	Signal	
1	Audio output (right channel)	0.5 Vrms/upper 1 kohm
2	Audio input (right channel)	0.5 Vrms/upper 10 kohm
3	Audio output (left channel)	0.5 Vrms/under 1 kohm
4	Earth (audio)	
5	Earth (blue)	
6	Audio input (left channel)	0.5 Vrms/upper 10 kohm
7	Blue (B) input	0.7 Vp-p/75 ohm
8	Function switching (video in/ext.)	L: 0 - 2V, H: 10 - 12V
9	Earth (green)	
10		
11	Green (G) input	0.7 Vp-p/75 ohm
12		
13	Earth (red)	
14	Earth	
15	Red (R) input	0.7 Vp-p/75 ohm
16	Fast blanking	L: 0 - 0.4V, H: 1 - 3V
17	Earth (video)	
18	Earth	
19	Video/sync output	1 Vp-p/75 ohm
20	Video/sync input	1 Vp-p/75 ohm
21	Earth (case)	

### ■ AV Connection to the Aerial Socket

- The A.V. apparatus can also be connected to the aerial socket of your TV receiver. In this case, it is advisable to select the "VCR1", "VCR2" or "VCR3" position for the best picture by pressing "0" key of the programme selector.

Each time "0" key is pressed, VCR Position changes as follows:

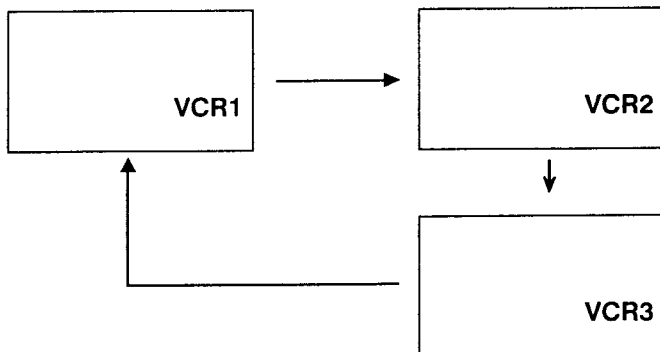

Note: VCR Position is specially designed for the playback of the AV equipments. The picture of the VCR playbacking may be distorted in other position.

- For further details concerning this connection and adjustment, refer to the operating instructions for the AV equipment.

## Specifications

Power source	AC 230 Volts, 50 Hz.
	Range of operation: 170V (min.) - 280V (max.)
Television system	B/G
Colour system	PAL
Channel coverage	VHF: 1-11 UHF: 21-69
Aerial input impedance	75 ohms

Picture Tube	CZP2510 CZP2510TX	CZP2910 CZP2910TX
	63cm diagonal 110 degree deflection	73cm diagonal 110 degree deflection

Audio output (Peak music power output)

CZP2510 CZP2510TX	CZP2910 CZP2910TX
15W + 15W	15W + 15W

Ext. terminals

Video input:

- Phono jack  $\times$  2 (1.0 Vp-p, 75 ohm)
- S-terminal  $\times$  1 (DIN 4-pin, separate Y/C signal input)

Audio input:

- Phono jack (R/L)  $\times$  2 (436 mVrms, more than 40K ohm)

Audio output (Audio Monitor Out):

- Phono jack (R/L)  $\times$  1 (436 mVrms, less than 600 ohm)

RGB terminal

- CENELEC standard 21-pin terminal

External speaker terminals

- 8 ohm, Output max. 5W

	CZP2510 CZP2510TX	CZP2910 CZP2910TX
Power consumption	115W	125W
Dimensions	595(W) $\times$ 541(H) $\times$ 450(D) mm	682(W) $\times$ 600(H) $\times$ 495(D) mm
Weight	approx. 30kg	approx. 40kg

Specifications subject to change without notice.

Part No. 4AA6P100340-- E2YV (A4-A)

**SANYO**

---

SANYO Electric Co., Ltd.