

DIGITAL PICTURE IN PICTURE
STEREO
TELETEXT

Table of contents

	Page		Page
Main supply	(1)	Alarm clock	(7)
Technical data	(1)	News flash	(7)
Aerial connection	(1)	Up dated page	(7)
General operation	(2)	FLOF/LIST	(8)
Tuning	(2)	Memory of TEXT pages	(8)
Automatic tuning	(2)	PIP (picture in picture)	(9)
Manual tuning	(3)	External video source connection	(9)
Remote control	(3)	PIP operation	(10)
Operation of main RC control key	(4~5)	VCR use	(11)
Teletext use	(6)	Audio monitor terminal	(11)
Page selection	(6)	S-VHS VCR connections	(12)
Sub coded page access	(6)	External speaker connection	(12)
Hold	(7)	21-pin terminal	(13)
Double letter height	(7)	Reception facilities	(14)
Concealed information	(7)		

Main features

We congratulate you on the acquisition of your colour television set which has been manufactured using the most advanced technical knowledge available and the most modern production and testing methods.

These are the important features of your colour TV set:

- This TV set allows you to receive CCIR-B/G PAL system.
 - Stereo system.
 - 61 function infra-red remote control including the teletext control.
 - Up to 30 broadcast stations in your reception area can be automatically found by the frequency tuning system and stored in the memory.
 - CENELEC standard 21-pin terminals is provided, so a VCR, video disc player or other AV apparatus can be connected.
 - More powerful sound can be enjoyed by using audio monitor terminal.
 - The TELETEXT Decoder is built in.
 - Complete functional safety because of automatic control of important parts and the use of modern transistors.
- We wish you lots of pleasure with your newly acquired television set.

Mains supply

- The TV set is prepared for a mains voltage 230 volts, 50 Hz, AC.
- Connect the power cord of the TV set to a wall outlet. When the TV set is not to be used for an extended period of time, it is advisable to disconnect the power cord from the power outlet.

WARNING! High voltages are used in the operation of this set. Refer service to qualified service personnel.

Technical data

Power source	AC 230V, 50Hz
Power consumption	IEC maximum operating condition 140W CENELEC normal operating condition 100W
Television system	System B/G
Colour system	PAL
Receiving channel	VHF 1~11, UHF 21~69
Aerial input impedance..	75ohm
AV terminal	
Audio monitor out	RCA type × 2 (R/L)
21-pin socket	CENELEC standard
S-terminal	S-VHS VCR standard
Audio input	RCA type × 2 (R/L)
Sound output	15 W × 2
Picture tube	78cm diagonal, 110 degree
Dimensions	810(W) × 701(H) × 552(D)mm
Weight	64 Kg

Aerial connection

1. The aerial socket is located on the back of your TV set.
2. If your present aerial produces clear reception of black/white pictures, then no alterations to the existing aerial may be necessary.
3. A colour picture of good quality requires a higher aerial signal than a black/white picture. If you tune your set to a station with a weak colour signal, your TV set automatically changes to black/white reproduction.
4. Connect a cable with plug from UHF/VHF aerial to aerial socket on the cabinet back.
5. For all aerial problems please consult your local dealer.

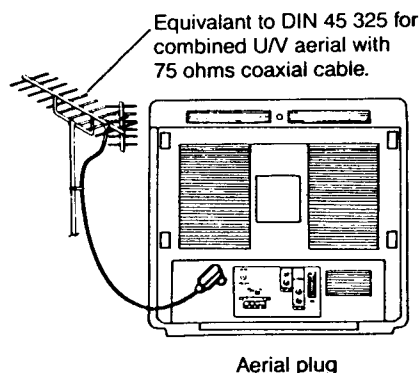

General operation

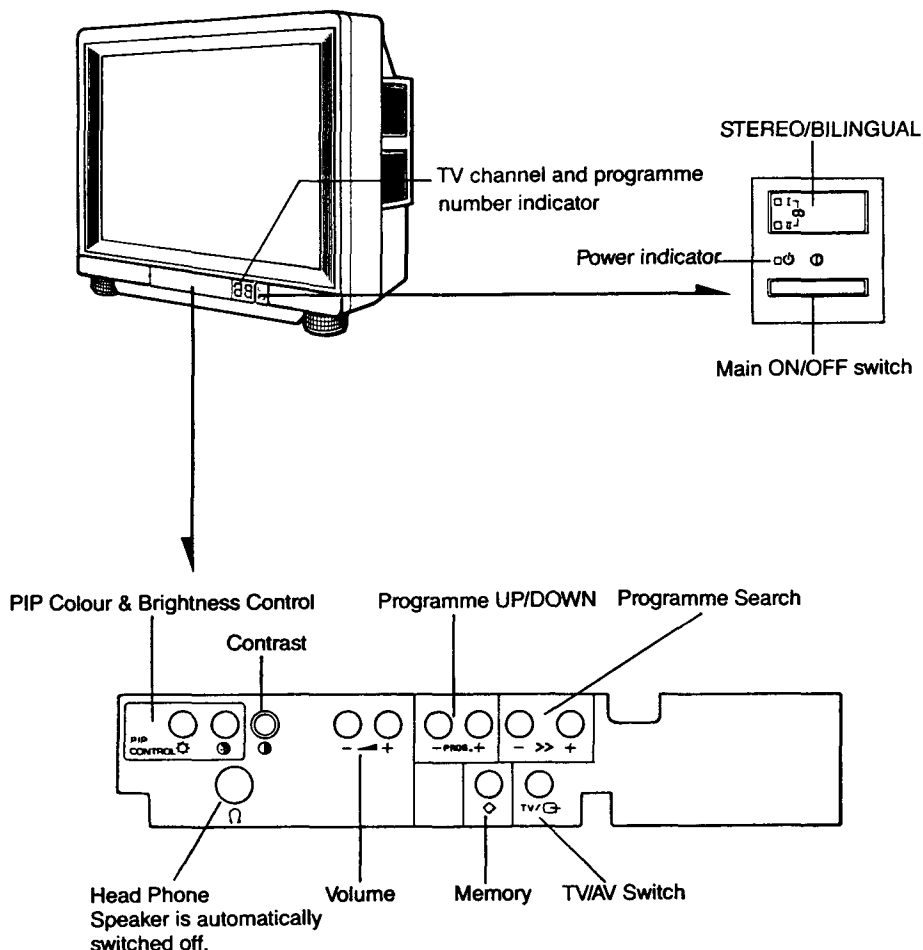

Automatic tuning

Programme and TV channel number indicator changes as follows:

Select the position No. you desire (from 0-29) with programme UP/DOWN key of TV set or remote control programme selection UP/DOWN key.

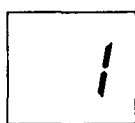

Press the channel search key of TV set and select TV station you desire.



(Channel No.)



Press the memory key of TV set.

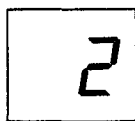

Press programme UP/DOWN key.



(Programme No.)

Note: When you select the programme number, you can input with remote control programme key:

1. One digit: Press remote control programme number (e.g. 1,2,3 ...)
2. Two digits: First press digit key "--/--", then press 2 digits of programme number (e.g. --/--,1,2, or --/--,2,5)

Indicator changes as follows

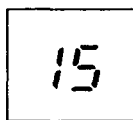
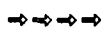
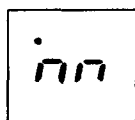

Manual tuning

Programme and TV channel number indicator changes as follows:

Select the position No. you desire (from 0~29) with programme UP/DOWN key of TV set or remote control programme selection UP/DOWN key.



⇒ First press channel selection key CS, then input TV channel number (e.g. CS, 0, 8) with remote control key. (From 1~9, input CS, 01... 09)

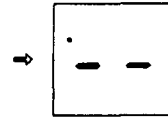

(Channel No.)

↓ Press the memory key of TV set.

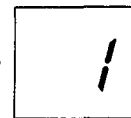
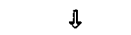

(Programme No.)

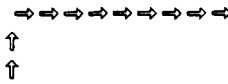

⇐ Press programme UP/DOWN key.

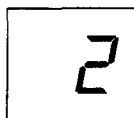

Selection of video source

VCR POSITION (0)

When using a VCR connected to the aerial socket, it would be better to select programme position "0". Because when you select "0" position, the characters of "VCR" are indicated at the corner of the TV main screen.

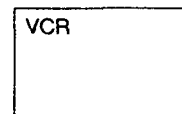

Sleep timer

This TV set incorporates a sleep timer function, which automatically switches off the TV set and switches it to the stand-by mode about 30 minutes after a TV broadcast finishes or there is no longer a TV signal. Thereafter, the TV set will not switch on even if a TV signal is applied. To switch the TV set on, use the main switch or the remote control transmitter.

Remote control

BATTERY INSTALLATION

1. Remove the battery cover by sliding it in direction of arrow.
2. Install two "AA" 1.5V batteries so that the "+" and "-" marks on the batteries match the "+" and "-" marks inside the unit.
3. Close the battery cover.

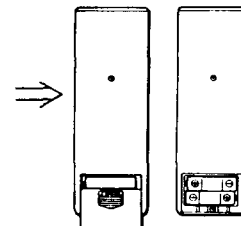

Note: Replace the batteries when the TV set is showing the following symptoms: Operation is unsteady or erratic, sometimes the transmitter does not control the TV. Discharged batteries may leak and damage the unit. The normal life of batteries should be from nine to ten months.

REMOTE CONTROL OPERATION

The main switch of the TV set must be in the "ON" position before remote control operation can be achieved. Point the transmitter toward the TV set, then press the appropriate function button. The power indicator blinks when a button of the transmitter is properly pressed.

Remote control key for TV use

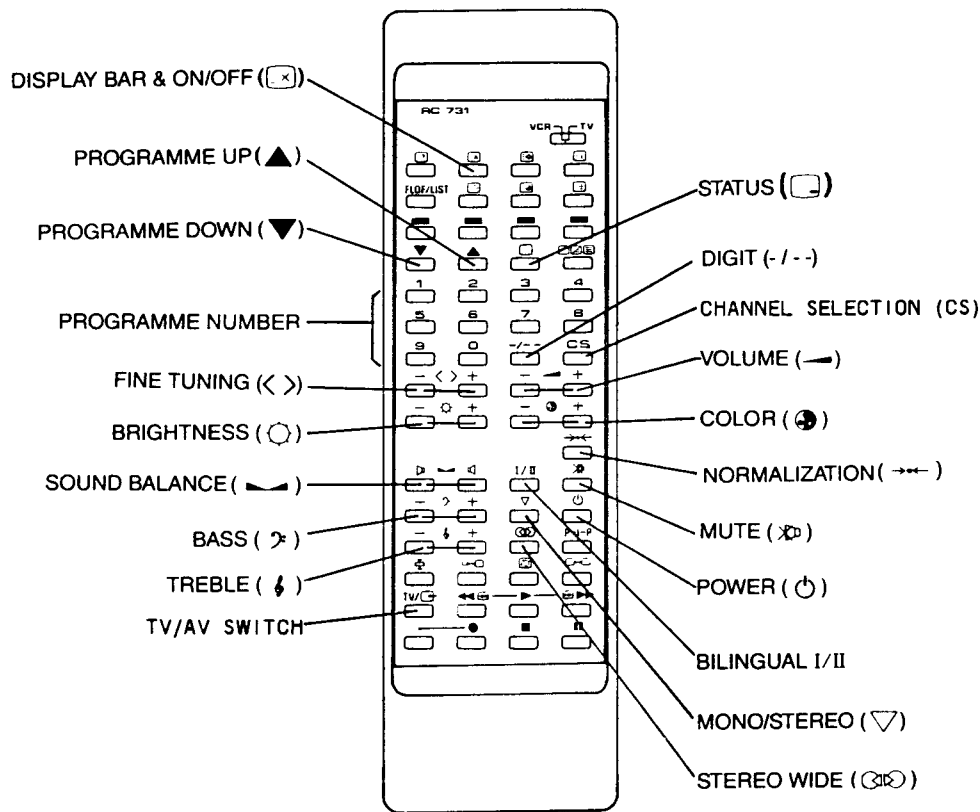

Operation of main remote control key

POWER ON/OFF

To switch the TV set on, press the power switch. To switch the TV set off, press it again. The stand-by indicator will remain illuminated when the TV set is switched off with this button. This indicates that the TV set is still partially energized. To disconnect the TV set completely from the mains, switch off with the main switch.

DIRECT PROGRAMME SELECTION (The 0~29 Channel)

For selection of programme position 0~9, press the corresponding button. If the required programme is more than 10, for example 23, first press "-/--" button and enter 2, then 3.

UP-DOWN PROGRAMME SELECTION (0~29)

Press the UP button once to increase the programme position. Press the DOWN button once to decrease the programme position.

Note: If the channel number "00" is stored in a programme position, this position will be skipped during programme selection. i.e. 1--2--3--4--1--2.

CHANNEL SELECTION (21~69)

Press the "CS" button once to switch channel selection operation. Using the 0 to 9 selection buttons, select the channel number of the desired TV station. Example 45, first press "CS" button, enter 4, then 5.

VOLUME

Volume can be adjusted by using the (+) and (-) button to increase or decrease the sound level.

COLOUR SATURATION

Adjust the picture's colour saturation by using (+) and (-) buttons, while observing the flesh tones of a human face on the screen.

BRIGHTNESS

The brightness of the picture can be adjusted by using the (+) and (-) buttons.

FINE TUNING

When the VCR/TV switch is in TV position, you can adjust the fine tuning by pressing the fine tuning button on the R/C transmitter.

STATUS

When the STATUS button is pressed, the programme indicator will display the channel number of the TV station that is being received at that programme position.

Note: The programme position is displayed on the top left corner of the screen, and if the selected TV station is also transmitting teletext, the time will also be displayed on the top right corner of the screen for six seconds.

PICTURE & SOUND ADJUSTMENTS AND SCREEN DISPLAY

When you press the volume button, colour saturation button, brightness button, balance button, bass button, and treble button of the RC transmitter, the control indicator bar appears on the bottom of the screen during pressing and for six seconds after releasing. The control indicator bar is displayed for each control as follows,

- Volume Green
- Colour saturation Red
- Brightness White
- Balance Purple
- Bass Blue
- Treble Yellow

Each control level is indicated by the position of the black marker on the coloured bar.

If you do not wish this bar to be displayed, press the CANCEL button on the RC transmitter. The bar will momentarily appear in red when displayed, and black when not displayed.

Note: The volume, colour, and brightness control levels are maintained in the memory even if the power is switched off. When the TV set is in AV mode, neither character nor indicator bar is displayed on the TV screen.

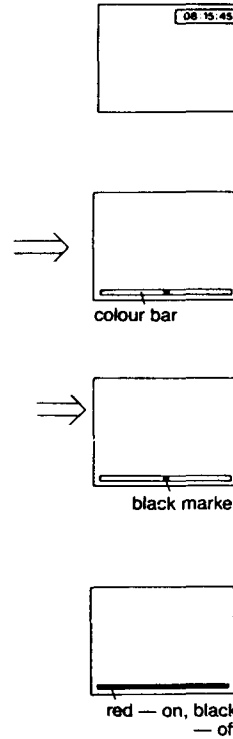

SOUND MUTE

Should you wish to mute the sound (e.g. while talking on the telephone) press sound mute button once. To switch the sound back on, press it again.

NORMALIZATION

Brightness and colour, bass and treble are set to the optimum levels automatically.

SOUND BALANCE

Press the () key to increase sound from the right speaker and press the () key to increase sound from the left speaker. Press it to the point where the sound volumes of both speakers become identical.

STEREO WIDE

If this key is pressed, a more ambient stereo sound is heard. Press it again to normal position.

MONO / STEREO

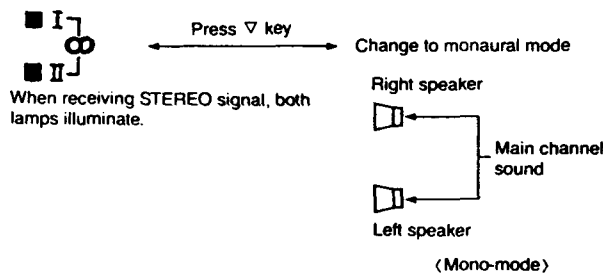

BILINGUAL I/II

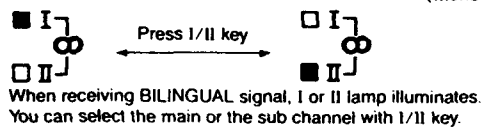

NICAM (Near Instantaneous Compand Audio Multiplex) Decoder is built in. For the NICAM decoder, please consult your local dealer.

TELETEXT use

The TELETEXT decoder incorporated in this set is a CCT (Computer Controlled Teletext).

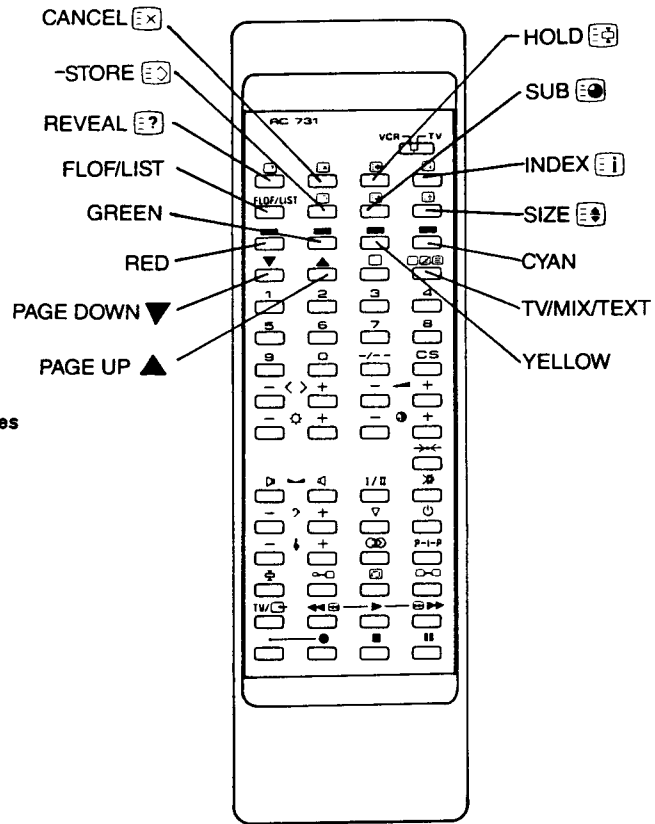

SWITCHING TO THE TELETEXT PAGE

Press the TV/MIX/TEXT button, then the screen changes as follows:

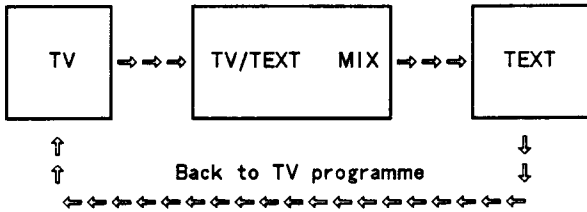

Page selection

DIRECT PAGE ACCESS

A page can be selected with the 0-9 buttons. For example, to display page 120, press buttons 1, 2 and 0. The selected page number will appear on the screen.

UP-DOWN PAGE ACCESS

If a page is displayed on the screen and you want to read the following page, you can press the UP button instead of selecting the page number. To bring back the previous page press the Down button. If you keep the UP or DOWN button pressed the page numbers will run up or down until you release the button.

The page number will change as follows by pressing the UP-DOWN button.

(+) P200--P201--P202.....P299--P200--P201

(-) P200--P299--P298.....P201--P200--P299

Note: In the FLOF/LIST mode, you can access the pages directly. (See FLOF/LIST on page 8)

Sub-coded page access

For TELETEXT information which is longer than one page, it may take some time for the automatic changing of sub pages to reach the sub page you require. It is possible, however, to enter the sub-page you require and then continue watching the normal television picture until the correct sub-page is reached.

- A. Select the required page using the page selection button.
- B. Press the SUB button. The character "S" and sub code digits "*****" will be displayed in top left of the screen.
- C. Enter the desired sub-page number before figure "S*****" disappears. For example, if you want to select sub-page 10, you must press 0,0,1 and 0 button. Then the character "+" is displayed following the page number.
- D. Press the CANCEL button to return to normal television programme. When the correct sub-page is reached the page number will appear on the normal television picture.
- E. Press the TEXT button to display the stored page.
- F. To clear the sub-coded page you must enter a new page number.

Note: It is not possible to select another television station during a sub-page access operation.

VIEWING TV WHILE SEARCHING FOR A PAGE

In some cases it can take some time to look for a page. In the interval you can view TV by pressing the CANCEL button. When the page arrives, the page number will appear on the normal TV picture. Press TEXT button to display the page.

Note: When you press the CANCEL button, the green " > " mark is displayed at the top right of the screen. While this " > " mark is displayed you can not select another TV channel.

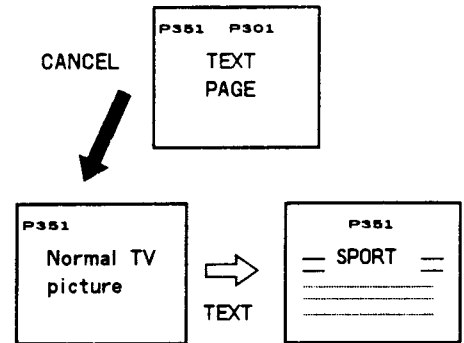

HOLD

If the teletext information is longer than one page, the pages are automatically changed. The automatic page changing can be cancelled by pressing the HOLD button. The word "HOLD" then appears on the top of the screen. Normal operation is restored by pressing the HOLD button again or entering a page number.

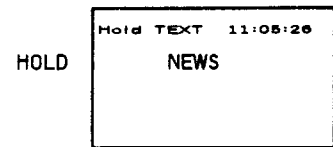

DOUBLE LETTER HEIGHT

Either the top or bottom half of the display can be expanded by pressing the SIZE button. When the SIZE button is pressed for the first time, the top half of the display is expanded. If it is pressed once again, the bottom half of the display is expanded. To return the display to normal-sized characters, this button should be pressed a third time.

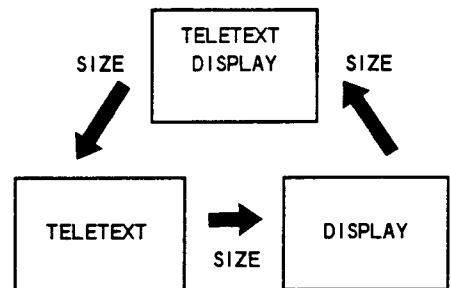

DISPLAYING CONCEALED INFORMATION

In one of the lists of contents you may find the heading "QUIZ" (concealed information). If you have selected the relevant page number questions will appear on the screen. You can find out the correct answer to the questions by pressing the REVEAL button. Press the REVEAL button again to make the answers disappear.

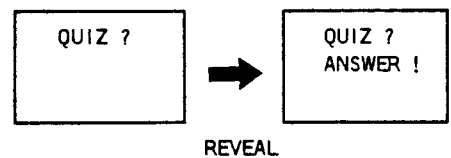

ALARM CLOCK

The Alarm Clock function can be set to operate at any requested time reminding viewers to carry out a specific task, i.e. making a phone call at a specified time.

First select either page 196(BBC1) or page 296(BBC2), using the page selection buttons. Press the SUB button, S**** will appear on the top of the screen. Select the time at which you require the alarm call. Example, for a call at 8.15 PM, press buttons 2015, watching that S**** changes to S20:15. Then press the CANCEL button to continue watching normal TV programmes. At 8:15 PM the words "ALARM CLOCK" in large letters will appear on the screen. Press the TEXT button to return to normal teletext operation. It is not possible to select another TV programme when in the CANCEL mode.

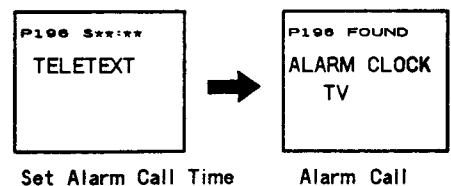

NEWS FLASH

If you select the news flash page and view the TV programme by pressing the CANCEL button, the moment news comes in, the word "NEWS FLASH" and the news appears over the normal TV picture. If you want to make the news disappear press the CANCEL button again. To recall the news press the TEXT button.

Note: It is not possible to select another TV station during a NEWS FLASH. You should first switch back to TV reception by pressing the TV button. You can, however, change both the picture and sound settings.

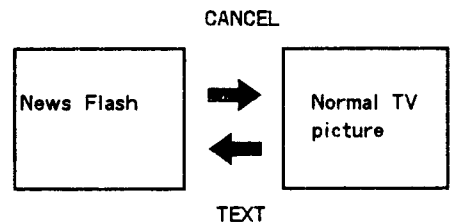

UPDATED PAGES

There are pages which are updated as events progress, such as sports results, news reports and traffic information. If you have selected one of the above pages from the list of contents and you want to view television but still be kept informed about the other events, press the CANCEL button. The page will disappear and the TV station which will broadcast this will appear in the screen. As soon as this page is updated, the page number will appear on the normal TV picture. To display the updated page on the screen press the TEXT button. The page will disappear when the CANCEL button is pressed again.

Note: It is not possible to select another TV station during an UPDATE. You should first switch back to TV reception by pressing the TV button. You can, however, change both the picture and sound settings.

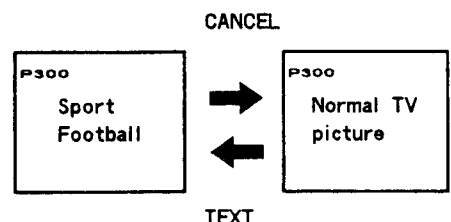

FLOF AND LIST (FLOF: Full-level-one feature)

When a broadcasting station provides FLOF service, you can access the text pages you desire quickly and easily.

FLOF

In the text mode, FLOF mode can be selected by pressing FLOF/LIST button.

Then the index page which the broadcasting station provides, appears on the screen. At the bottom of the screen, red, green, yellow and cyan letters and " F " letters are indicated.

You can select a programme out of four programmes, by pressing one of the coloured buttons on the RC transmitter. (For example, when pressing red, the red colour programme is selected)

In the same way, you can select the programme which is indicated at the bottom of the screen by pressing the colour button.

To get back to the initial index page, press the "INDEX" button.

LIST

In the LIST mode, the four coloured page numbers and " L " letter are indicated on the bottom of the screen. The number on the left side is enclosed by a red frame. First, input the page number you desire, into each coloured position using the digit buttons, then press the "STORE" button for about two seconds.

When the page number is memorized, the four coloured numbers change into white frame momentarily.

After you memorize the four page numbers, you can select the page you desire by pressing the red, green, yellow or cyan button. Even if you select another page by inputting a new page number, (See direct page selection), the memorized pages return after switching power off or changing the programme position or pressing the INDEX button.

NON FLOF SERVICE

When the station does not have FLOF service, and you press the FLOF mode button, the INDEX page (P100) is automatically displayed. At the bottom of the screen, the four page numbers 100, 199, 101, 102 are also displayed.

Then, when you select a random page number out of the displayed four pages by pressing a colour button, the text of that page is displayed. The selected page minus one, plus one, and plus two page numbers are displayed but their display order is at random. Of course at any time you can select new pages by inputting new page numbers.

MEMORY OF THE TEXT PAGES

When you assign a broadcasting station which is providing a TEXT service to some programme positions of your TV set, four pages of TEXT can be memorized on each programme position 0~15.

(To memorize the TEXT pages, see " LIST mode ") If it is required to have more than four instant text pages available from the same text service, tune the necessary number of programme positions to the same TV channel.

i.e. TV programme position 0.... page,300,301,302,303
1.... page,304,305,306,307
2.... page,308,309,310,311
.....
15... page,411,412,413,414

The memory capacity is 16 programme positions and four pages per each position.

FLOF mode

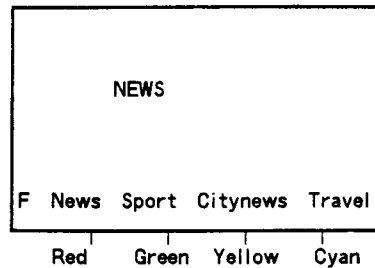
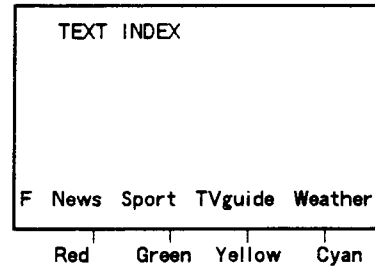

LIST mode

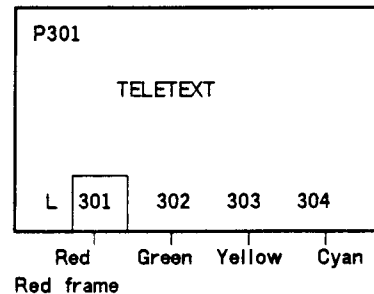

Red frame

PIP (Picture in Picture) operation

Your television is designed with a PIP (Picture in Picture) feature. A small window screen is available within the TV's main screen.

This PIP feature may be used in the following ways:

(You need to prepare the external video source to use this feature.)

- A. While watching a television programme, you may select to view an external video source on the small screen.
- B. While watching an external video source, you may select to view a television programme on the small screen.
- C. You may select to watch the same programme on both the TV's main screen and PIP screen.
- D. You may watch an out door view or another room by using video camera for security.

Note: The PIP screen audio signal cannot be heard. Only the sound from the TV's main screen signal is available through the television speaker.

EXTERNAL VIDEO SOURCE CONNECTION

When you connect the RF output of an external video source to the TV aerial socket, you can watch only external video source on the PIP screen and main screen, but can not watch TV programme on PIP or main screen. If you want to watch TV programme, you can select TV channel with programme selector.

When the TV set is in the TEXT mode, you can not change it to AV mode directly. First, change it to TV mode, and then change it to AV mode.

If you have two external video equipment, you can watch simultaneously two external video picture in PIP; and main screen. In this case, connect RF output of one VCR to TV's aerial socket, and the other VCR'S VIDEO/AUDIO out put to the 21-pin terminal of TV set respectively.

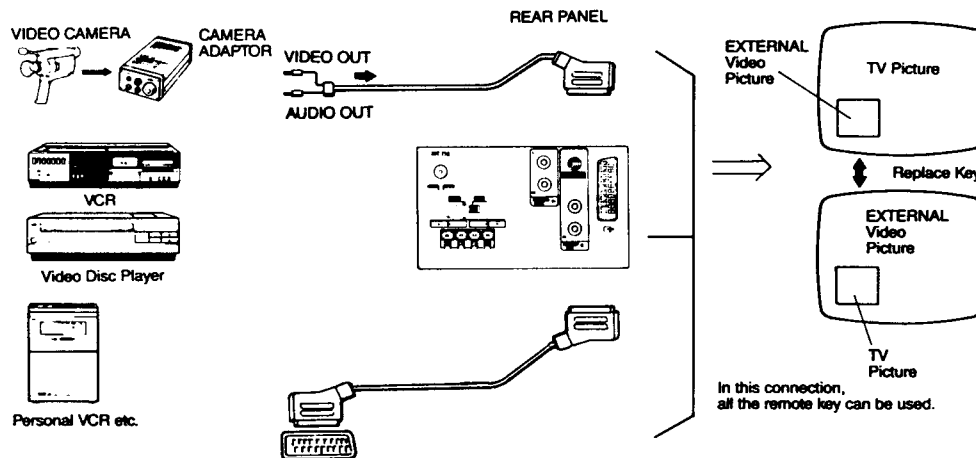

PIP key

The TV must be switched on and should be tuned to the desired programme for the main screen. Press the PIP key once to activate the PIP feature. (Pressing the PIP key again will return the TV to normal operation). A small window screen appears in the lower left corner of the main screen.

Note: If the television is switched off and back on using the POWER key, the PIP key must be pressed to activate the PIP feature.

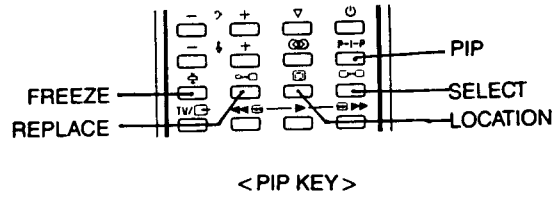
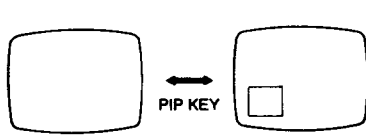

SELECT key

To select the video programme source for the PIP screen, press the SELECT key to select the TV programme source or the external video source.

If the same programme source has been selected for both screens, the same picture will appear on both screens.

Note: If the PIP feature is switched off and back on, the previous programme source will be selected. If a power interruption occurs, the programme source will return to the "TV" mode.

REPLACE key

Press the REPLACE key to exchange the programmes between the TV's main screen and PIP screen. As the programme on the TV's main screen is changed, the sound will also change to the corresponding programme signal. This key can be used if you wish to listen to the PIP screen programme. Press the REPLACE key to exchange the programmes.

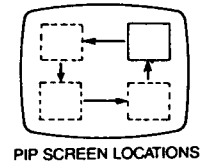
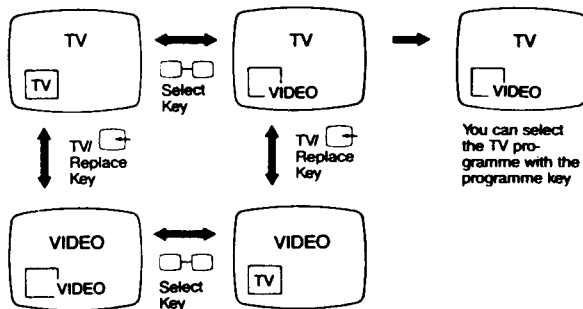

LOCATION key

Press the LOCATION key to change the position of the PIP screen. Each time the LOCATION key is pressed, the PIP screen will be shifted to another corner of the TV's main screen.

FREEZE key

Press the FREEZE key once to momentarily stop the picture motion in the PIP screen. (Pressing the FREEZE key again will release the picture). This key is especially useful when watching a ballgame or a motive with dramatic scenes. First select the same programme source on the TV's main screen and the PIP screen, then use the FREEZE key to stop the action in the PIP screen.

Note: The POWER, PIP, SELECT, and REPLACE keys will override the FREEZE feature.

PIP MONITOR controls

The PIP screen picture quality may be adjusted by using the following PIP MONITOR controls:

- A: Adjust the brightness control for desired picture brightness.
- B: Adjust the colour control for the desired amount of colour intensity.

The PIP MONITOR controls will not affect the TV's main screen picture.

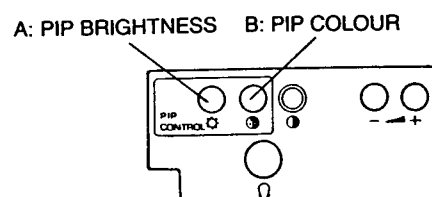

VCR use

For VCR use set the TV/VCR switch to "VCR" position.

STOP BUTTON

Use to stop the movement of the tape.

PLAY BUTTON

Use to playback the tape.

FF/CUE BUTTON

Use to advance the tape at fast speed, or in order to playback the tape at fast speed.

REW/REVIEW BUTTON

Use to rewind the tape, or in order to playback the tape in reverse at fast speed.

RECORD BUTTON

Use to record on the tape. Press two buttons at the same time.

PAUSE/STILL BUTTON

Use to temporarily stop (Pause) the tape when recording, or in order to see a still image during playback.

CH UP DOWN +/- BUTTON

Use to change the programming position for the VCR.

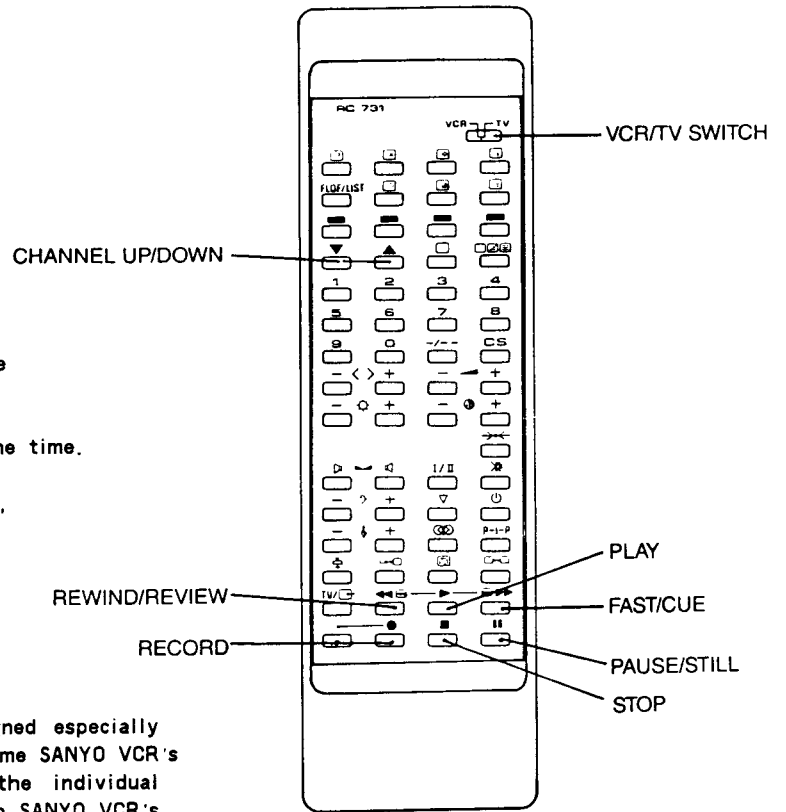

Note: This remote control transmitter has been designed especially to be used in conjunction with selected SANYO VCR's. Some SANYO VCR's may have their own functions, so please refer to the individual instruction booklet when using this remote control with SANYO VCR's to ensure compatibility.

Audio terminal

More powerful sound can be enjoyed by using your audio apparatus. Connect the audio signal source from audio-monitor-out terminal to the line-in or aux terminal of the audio apparatus. Next, adjust the volume control on the audio apparatus to you desired volume level. (The sound is not affected by the volume control on the TV, therefore set to a minimum volume level)

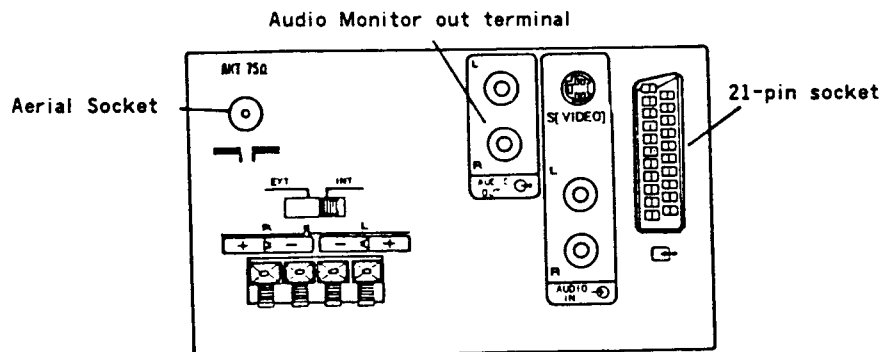

S-VHS VCR connections

S-VHS VCR is designed with a highly advanced techniques. So the visual quality of S-VHS VCR is better than the other popular VHS VCR. S-VHS VCR can be enjoyed by using S-terminal.

Example of S-VHS VCR connection

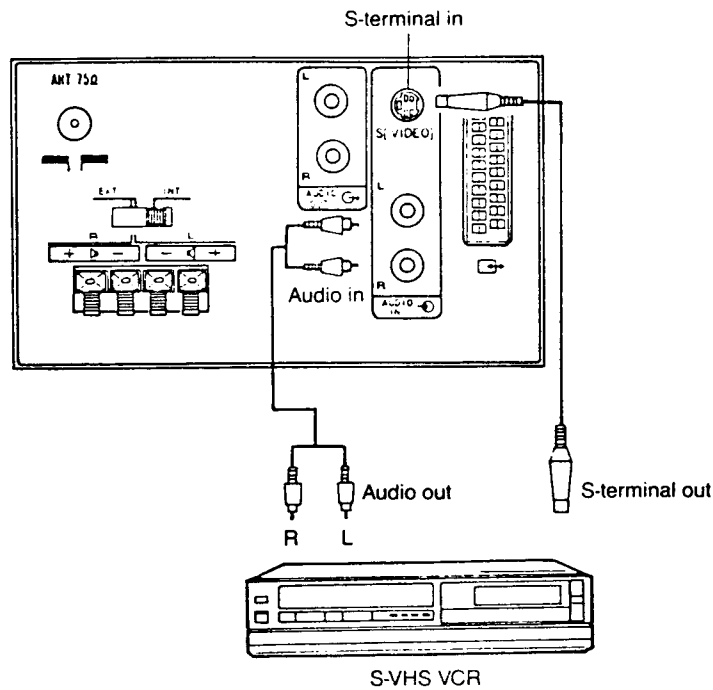

Input terminals

In order to watch the playback from the S-VHS VCR, the output terminal of the VCR in use must be connected to the S-terminal in and Audio-in terminals and then select the video mode with TV/AV key.

If the audio signal from the VCR is stereo, be sure to connect the right and left channels to the respective right and left Audio-in terminals. If the external audio signal is a monaural one, connect it to the right or left terminal of Audio-in. Then select the monaural mode and the audio channel in the TV set with the remote control mono/stereo and I/II key.

Prior to connecting the S-VHS VCR, be sure to carefully read the instruction booklet of the equipment involved.

External speaker connection

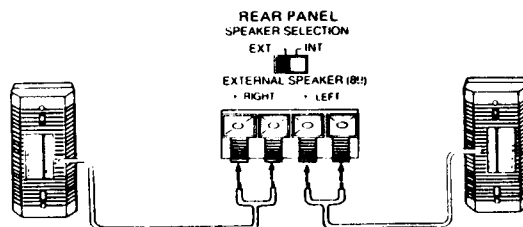

Note: In this case, set "Speaker selection" switch to the "EXT" position. Connect R/L speaker to R/L terminal respectively.

21 pin terminal

A personal computer, VCR, video disc player or other AV equipment can be connected to the 21-pin socket on the rear of the TV set.

- The connector (CENELEC standard 21-pin type) should be wired as illustrated below.
- The 21-pin plug with cable is obtainable from your local dealer.
- For this connection and adjustment, refer to the operating instructions for the personal computer etc.

CONNECTION

The specification of the 21-pin connector is as follows:

Pin No.	Signal
1. Audio output (right channel)	0.5Vrms/under 1K ohm
2. Audio input (right channel)	0.5Vrms/upper 10k ohm
3. Audio output (left channel)	0.5Vrms/under 1k ohm
4. Earth (audio)	
5. Earth (blue)	
6. Audio input (left channel)	0.5Vrms/upper 10k ohm
7. Blue (B) input	0.7Vp-p/75 ohm
8. Function switching (TV/EXT.)	L: 0~2V, H: 10~12V
9. Earth (green)	
10.	
11. Green (G) input	0.7Vp-p/75 ohm
12.	
13. Earth (red)	
14. Earth	
15. Red (R) input	0.7Vp-p/75 ohm
16. Fast blanking	L: 0~0.4V, H: 1~3V
17. Earth (video)	
18. Earth	
19. Video sync. output	1Vp-p/75 ohm
20. Video sync. input	1Vp-p/75 ohm
21. Earth (case)	

USE OF THE 21-PIN TERMINAL

If the 21-pin terminal is used for connection of video equipment, audio equipment or a personal computer, note the following points.

A. Use of video equipment

For playback of VCR tapes or video disc, use equipment which has a pin-8 input function signal.

When equipment which has this function signal is used, the TV set is automatically switched to the video mode, and the remote-control unit cannot be used for TV/VIDEO switching.

For VCR recording, the existence or not of the function signal has no effect. When the equipment which does not have this function signal is used, TV set should be switched to AV mode by pressing TV/AV button.

B. Use of the personal computer

The personal computer must be the type which has a pin-8 function signal and a pin-16 fast signal (TV/RGB switching). A personal computer which does not have these two signals cannot be used. If the personal computer has RF output terminal, it can be used making the connection to the aerial terminal.

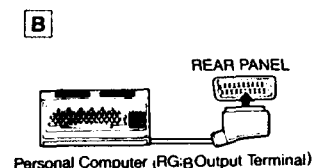
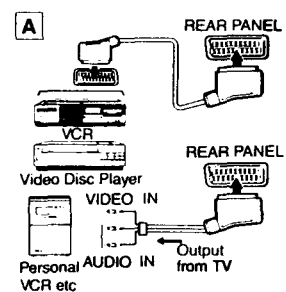
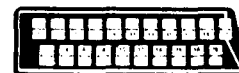

Reception Facilities:

The station operation on the New Zealand television system is on the following TV bands and channels.

TV band	Broadcast Channels	The channel No. indicated in TV channel indicator.
VHF I	1	01
	2	03
	3	04
VHF III	4	05
	5	06
	6	07
	7	08
	8	09
	9	10
	10	11
	11	12
UHF	21	21
	22	22
	23	23
	24	24
	25	25
	26	26
	27	27
	28	28
	29	29
	30	30
	31	31
	32	32
	33	33
	34	34
	35	35
	36	36
37	37	
38	38	

TV band	Broadcast Channel	The channel No. indicated in TV channel indicator.
UHF	39	39
	40	40
	41	41
	42	42
	43	43
	44	44
	45	45
	46	46
	47	47
	48	48
	49	49
	50	50
	51	51
	52	52
	53	53
	54	54
	55	55
	56	56
	57	57
	58	58
	59	59
	60	60
	61	61
	62	62
	63	63
	64	64
	65	65
	66	66
	67	67
	68	68
	69	69