

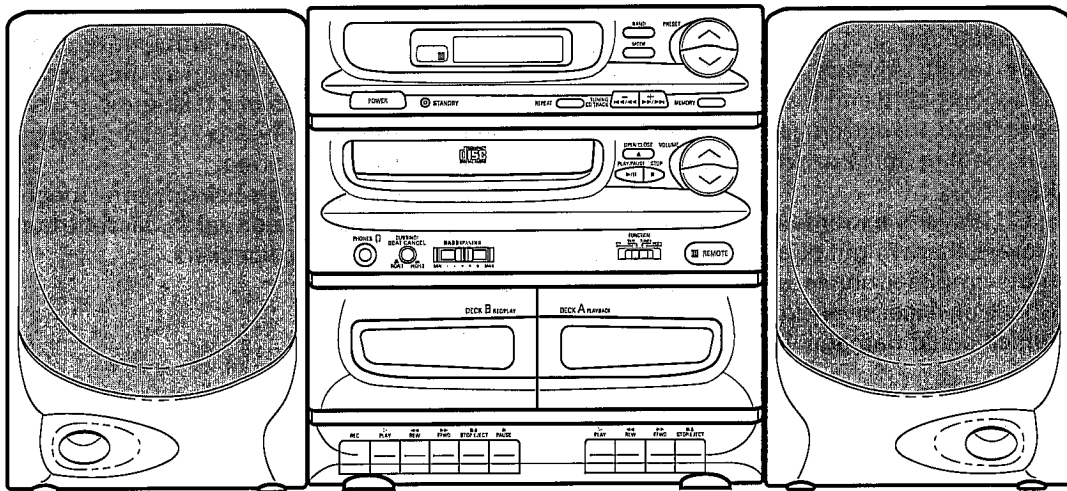

INSTRUCTION MANUAL

DC-D3

Mini Component System



CAUTION - USE OF CONTROLS OR ADJUSTMENTS OR PERFORMANCE OF PROCEDURES OTHER THAN THOSE SPECIFIED IN THE OPERATING INSTRUCTIONS MAY RESULT IN HAZARDOUS RADIATION EXPOSURE.

THE COMPACT DISC PLAYER SHOULD NOT BE ADJUSTED OR REPAIRED BY ANYONE EXCEPT PROPERLY QUALIFIED PERSONNEL.

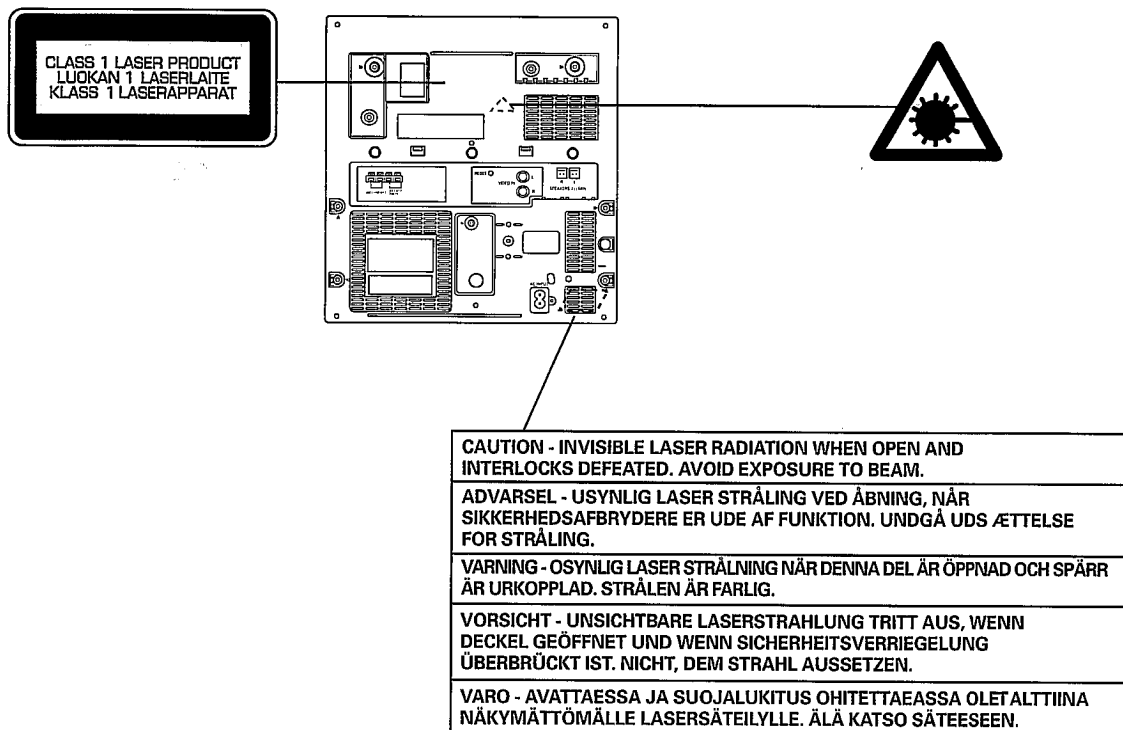

PRECAUTIONS

- If water should enter the unit, electrical shock or malfunction may result. Always use it in a place where there is low humidity and little dust.
- Do not use where there are extremes of temperature (below 5°C or exceeding 35°C) or where direct sunlight may strike it.
- Because of the CD player's extremely low noise and wide dynamic range, there might be a tendency to set the volume on the amplifier unnecessarily high. Doing so may produce an excessively large output from the amplifier which could damage your speakers.
- Sudden changes in the ambient temperature may cause condensation to form on the optical lens inside the unit. If this happens, take out the disc, leave the unit with the disc tray extended for about 1 hour, and then proceed to operate.
- The system's speakers use powerful magnets. Do not place timepieces, credit cards, cassette tapes or video tapes, etc. near the speakers.

CONNECTIONS

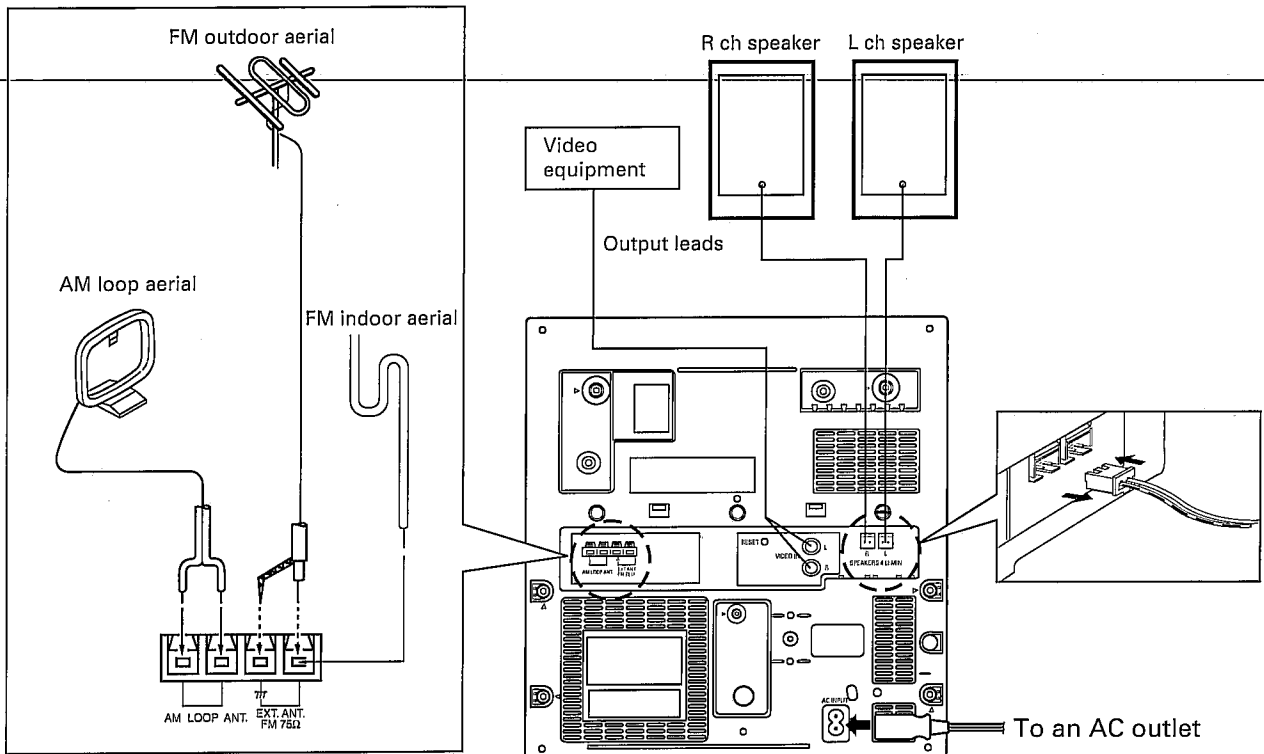

Note:

Do not connect the mains lead to an AC outlet until all connections have been made.

The system is not disconnected from the mains unless the mains lead is unplugged from the AC outlet.

Speakers

To achieve proper stereo reproduction, identical connections must be made at the speakers and this unit. Connect the speaker wire plug to the SPEAKERS socket of the unit.

FM aerials

The FM indoor aerial is sufficient to receive most local FM broadcasts and should be connected to the EXT. ANT. terminal. Extend the aerial wire as straight as possible and, while listening to the sound from the system, secure it in a position which yields minimal distortion and noise.

In fringe areas or where reception is distorted or noisy, an FM outdoor aerial (not supplied) should be connected instead of the indoor aerial. The terminals will accept 75-ohm coaxial cable. Consult your dealer.

AM loop aerial

Assemble the loop aerial as shown in figure.

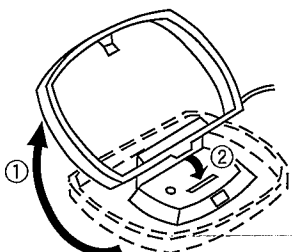

Unwind the aerial wires, then connect them to the AM LOOP ANT. terminals. Place the loop aerial in a position which yields the best AM reception, or attach it to a wall or other surface as shown in figure.

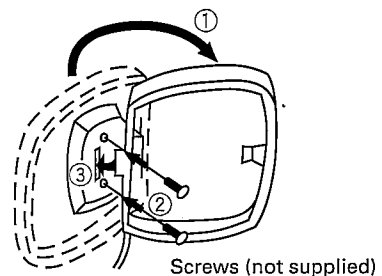

Screws (not supplied)

Note:

To minimize noise, the speaker, mains and any other leads should not come close to the FM indoor or outdoor aerial lead and AM loop aerial. Do not place the aerial leads close to the system or TV.

Video equipment

Connect leads (not supplied) from the audio output sockets of the video equipment to the VIDEO IN sockets.

Headphones

Connect stereo headphones (not supplied) to the PHONES socket for monitoring or for private listening. The speakers are automatically disconnected when headphones are connected.

CONTROLS

Tuner section

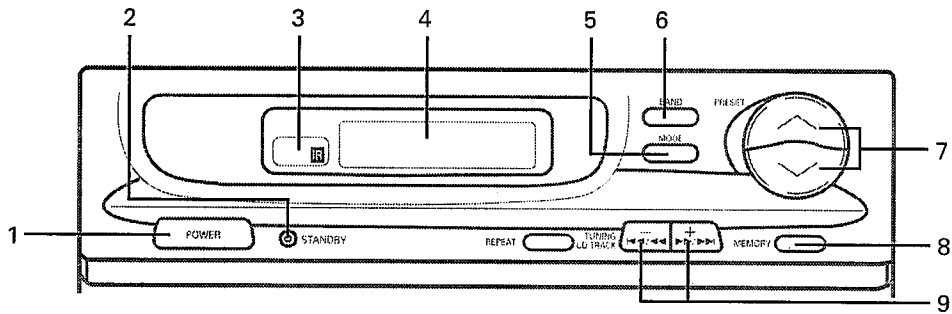

- | | |
|--------------------------------|--|
| 1. Power button (POWER) | 6. Band select button (BAND) |
| 2. Standby indicator (STANDBY) | 7. Preset tuning buttons (PRESET) |
| 3. Remote sensor (IR) | 8. Tuner and CD memory button (MEMORY) |
| 4. Display | 9. Tuning and CD track buttons (TUNING/CD TRACK) |
| 5. FM mode button (MODE) | |

CD player/Amplifier section

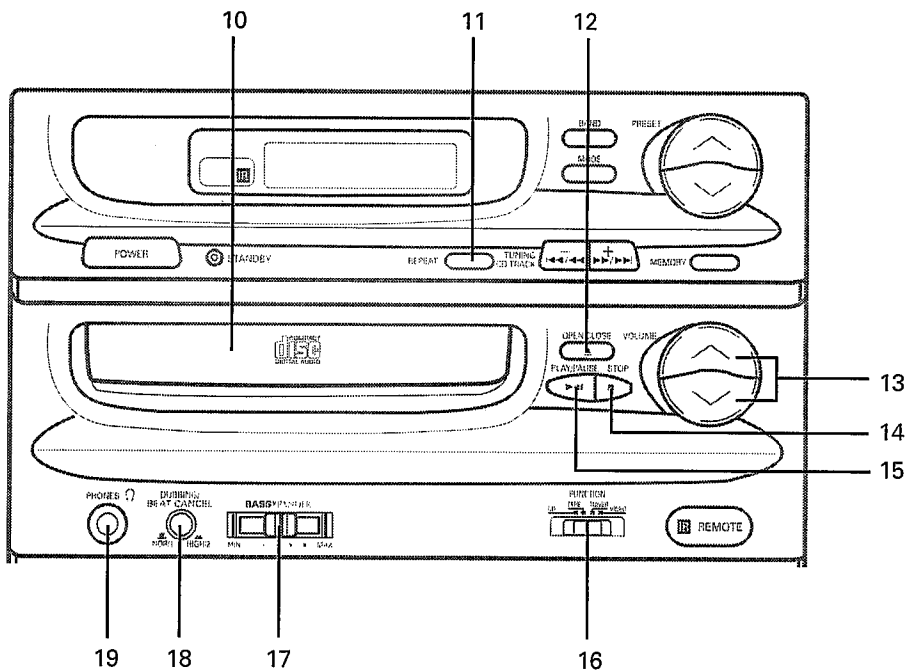

- | | |
|--|--|
| 10. Disc tray | 15. Play/Pause button (PLAY/PAUSE) |
| 11. Repeat play button (REPEAT) | 16. Function switch (FUNCTION) |
| 12. Disc tray open/close button (OPEN/CLOSE) | 17. Bass expander control (BASSXPANDER) |
| 13. Volume buttons (VOLUME) | 18. Dubbing speed/Beat cancel button (DUBBING/BEAT CANCEL) |
| 14. Stop button (STOP) | 19. Headphones socket (PHONES) |

Cassette deck section

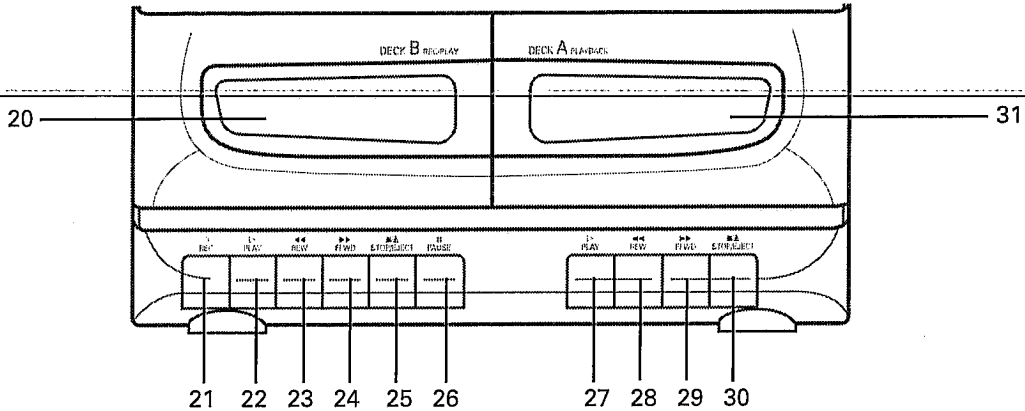

DECK B

- 20. Cassette holder
- 21. Record button (○ REC)
- 22. Play button (▷ PLAY)
- 23. Rewind button (◀◀ REW)
- 24. Fast forward button (▶▶ FFWD)
- 25. Stop/Eject button (■ STOP/▲ EJECT)
- 26. Pause button (|| PAUSE)

DECK A

- 27. Play button (▷ PLAY)
- 28. Rewind button (◀◀ REW)
- 29. Fast forward button (▶▶ FFWD)
- 30. Stop/Eject button (■ STOP/▲ EJECT)
- 31. Cassette holder

REMOTE CONTROL

Controls

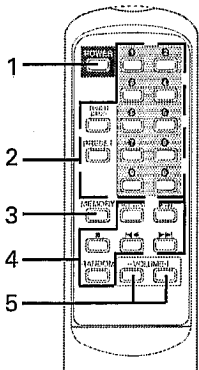

- 1. Power button (POWER)
- 2. Tuner controls
TUNER/BAND: Band select button
PRESET: Preset tuning button
Number buttons: 1-9, 0
- 3. MEMORY: Tuner and CD memory button
- 4. CD player controls
REPEAT: Repeat play button
▶/|| : Play/Pause button
■ : Stop button
◀◀▶▶ : Skip/Search buttons
RANDOM: Random play button
- 5. Volume buttons (—VOLUME+)

Number buttons (1-9, 0)

These buttons are used to select preset radio stations. Press the TUNER/BAND button, then two number buttons to select preset radio stations.

Example: To select No. 3, press 0, then 3.
To select No. 10, press 1, then 0.

Inserting batteries

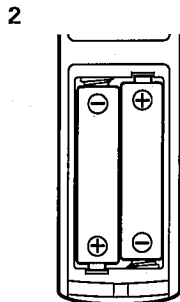
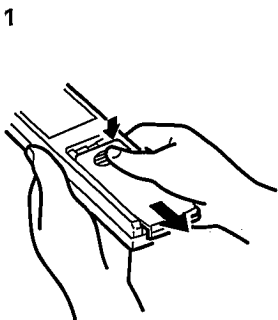

Two AA/R6/SUM-3 batteries
(not supplied)

NOTE:

Always remove batteries if the remote control is not to be used for a month or more. Batteries left in the unit may leak and cause damage.

Remote control range

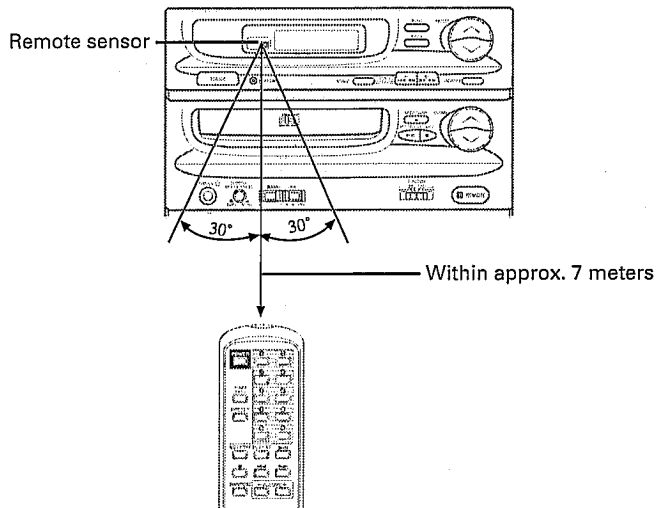

Operation

By using the remote control, you can operate the system in the same way as with the controls on the main unit.

BEFORE OPERATION

Turning the power on and off

Press the POWER button. The STANDBY indicator goes out, then the function mode appears and display lights. To turn off the power, press the POWER button again. The STANDBY indicator lights.

- When the mains lead is connected to the AC outlet, the STANDBY indicator lights and the unit will respond to commands from the remote control.

Selecting the function

Set the FUNCTION switch to the desired position.

- When the function selector is moved from "CD" to another position, CD play stops automatically.

Adjusting the volume

Press the "▲" or "▼" VOLUME button or press the "+" or "-" VOLUME button on the remote control.

Bass expander system

Adjust the BASSXPANDER control to enhance the bass sound.

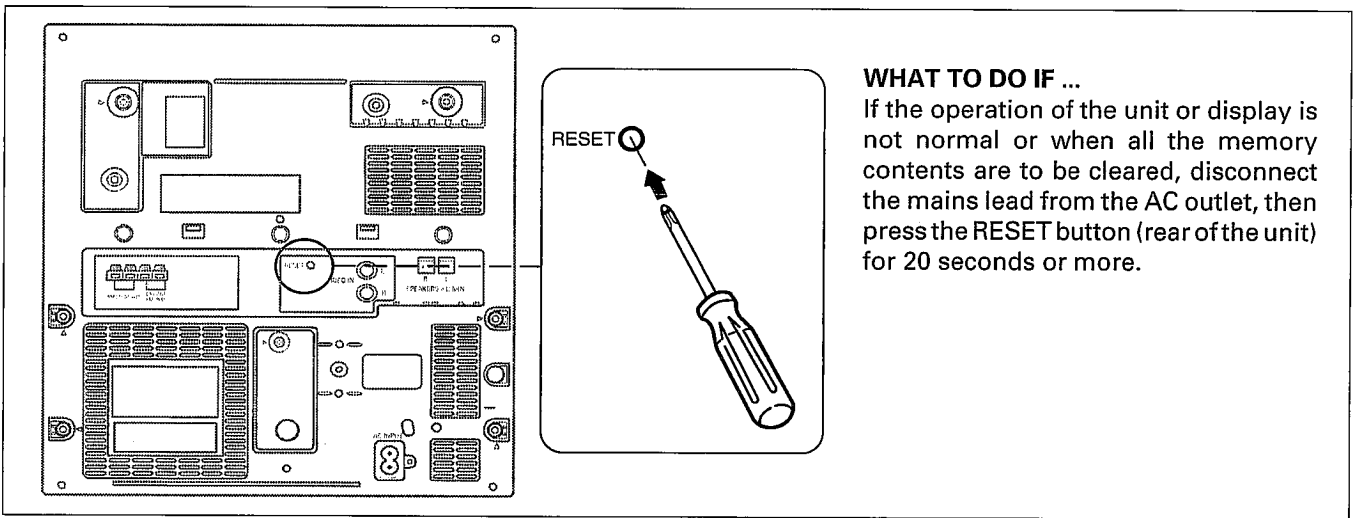

WHAT TO DO IF ...

If the operation of the unit or display is not normal or when all the memory contents are to be cleared, disconnect the mains lead from the AC outlet, then press the RESET button (rear of the unit) for 20 seconds or more.

CD PLAY

Only compact discs bearing the symbol below can be played. In addition to conventional 12 cm CDs, this system can be used to play 8 cm CDs without an adaptor.

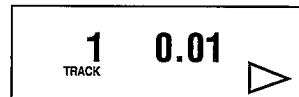

1. Set the FUNCTION switch to CD. "nO dISC" appears on the display.
2. Press the OPEN/CLOSE button. The disc tray slides out and "OPEn" appears on the display.
3. Place the disc with the label facing up on the disc tray.

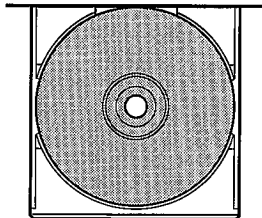

For 12 cm CD

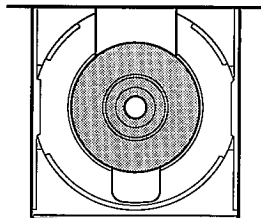

For 8 cm CD

The total number of tracks and total play time are displayed.

5. Press the PLAY/PAUSE button.

">" appears, and play starts from the first track. The track number and elapsed play time for the current track are displayed.

- If you press the PLAY/PAUSE button while the tray is still open, it will close, and play will begin automatically.
 - To start play from the desired track, select the track by using the CD TRACK buttons, then press the PLAY/PAUSE button.
6. Press the STOP button to end disc play. The total number of tracks and total play time are displayed. When the last track has been played, the player stops automatically.
 - When the OPEN/CLOSE button is pressed during play, play will stop and the disc tray will slide out.

4. Press the OPEN/CLOSE button again to close the disc tray.

Notes on handling compact discs

- Fingerprints and dust should be carefully wiped off the signal surface of the disc (glossy side) with a soft cloth. Wipe in a straight motion from the centre to the outside of the disc.
- Never use chemicals such as record cleaning sprays, antistatic sprays or fluids, benzene or thinner to clean compact discs. These chemicals will permanently damage the plastic surface of the disc.
- Always place the compact disc in the disc tray with the label facing upward. Compact discs can be played on only one side.
- To remove a disc from its storage case, press down on the centre of the case and lift the disc out, holding it carefully by the edges.
- Discs should be returned to their cases after use to protect them from dust and scratches.
- To prevent warping the disc, do not expose it to direct sunlight, high humidity or high temperatures for extended periods of time.
- Do not apply paper or write anything on the disc surface. Sharp writing instruments, or the inks used in some felt-tip pens, may damage the surfaces of the disc.

Temporarily stopping play

Press the PLAY/PAUSE button. "▷" blinks on the display. To resume play, press the button again.

Skip play

To skip to track 6 while track 3 is playing, press the ►►/►► CD TRACK button repeatedly until "6" appears in the TRACK section on the display.

To skip back to track 3 while track 6 is playing, press the ◀◀/◀◀ CD TRACK button repeatedly until "3" appears.

Search (forward/reverse)

If the ◀◀/◀◀ or ►►/►► CD TRACK button is pressed and held during play, the player will search at high speed in the forward or reverse direction. When the button is released, normal play will continue.

Random play

Press the RANDOM button on the remote control to begin random play. The player will automatically select and play tracks on the disc at random. "RANDOM" appears on the display.

- If the RANDOM button is pressed during random play, the player will select the next random track.

Repeat play

Press the REPEAT button during play. The player will play all tracks or all programmed tracks repeatedly. If RANDOM Play is selected, all tracks will be repeated at random. "REPEAT" appears on the display. To cancel repeat play, press the REPEAT button again. "REPEAT" disappears.

PROGRAMMED PLAY

Up to 24 selections on a disc can be programmed for play in any order.

- The tracks must be programmed in the stop mode.
- The same track can be programmed more than once.

Example:

To programme tracks 5, 2, 6 and 10

1. Press the MEMORY button.

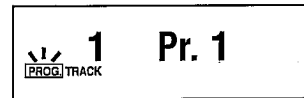

2. Select track 5 by pressing the ►►/►► CD TRACK button 4 times.

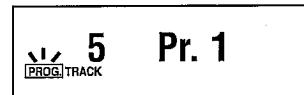

3. Press the MEMORY button. "PROG." remains lit.
4. Select track 2 by pressing the ◀◀/◀◀ CD TRACK button 3 times.

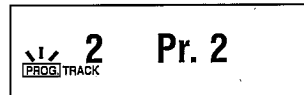

5. Press the MEMORY button. "PROG." remains lit.
6. Programme the remaining tracks in the same way.
7. Press the PLAY/PAUSE button to start play.

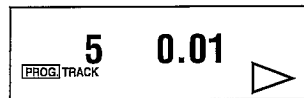

When all programmed selections have played, the player stops automatically.

- The programme contents are retained in memory.

- The maximum number of selections that can be programmed is 24. If you try to enter more selections, the programme details for the first selected track appear on the display.
- The programme is cleared in the following cases:
 - When the STOP button is pressed in the stop mode.
 - When the OPEN/CLOSE button is pressed.

Checking the programme

Each time the MEMORY button is pressed in the stop mode, the programmed details sequentially appear on the display.

Changing a programme

To add a new selection to a programme:

1. In the stop mode, press the MEMORY button repeatedly until "-- --" is displayed.
2. Select a track number.
3. Press the MEMORY button.

To change a selection:

1. In the stop mode, press the MEMORY button repeatedly until the selection to be replaced is displayed.
2. Select a track number.
3. Press the MEMORY button.

NOTE:

Programmed selections cannot be erased individually.

LISTENING TO TAPES

DECK A is for playback only; DECK B is for both playback and recording.

Do not turn the unit off while the tape is running. Otherwise, the pinch roller may be damaged.

1. Set the FUNCTION switch to TAPE. "TA" appears on the display.
2. Press the ■ STOP/ ▲ EJECT button to open the cassette holder.
3. Load the cassette(s).

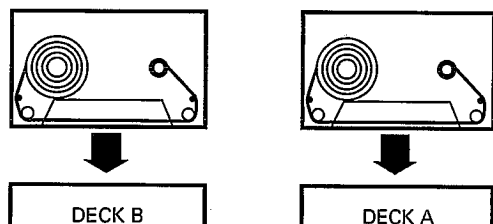

After loading the cassette(s), push the cassette holder back into position.

4. Press the ▷ PLAY button (DECK A or DECK B) to begin playback.
5. Press the ■ STOP/ ▲ EJECT button to stop playback at any time. Press it again to remove the cassette. When the end of the tape has been reached, automatic stop will be activated.

Note:

- Endless tapes cannot be used.
- Do not use C-120 tapes. They may jam in the mechanism.

Pause (DECK B)

Press the || PAUSE button to temporarily stop playback or recording. Press it again to resume operation.

Fast forward and rewind

Press the ►► FFWD or ◀◀ REW button.

When the tape has been wound to the end, the deck automatically stops.

Notes:

While playing or recording, do not press the ►► F FWD or ◀◀ REW button of the other deck, or the sound quality may deteriorate.

Continuous playback (From DECK A to DECK B)

1. Press the ▷ PLAY button of DECK A. Deck A playback will begin.
2. Press the || PAUSE button of DECK B.
3. Press the ▷ PLAY button of DECK B. Deck B enters the pause mode. When the tape automatically stops on DECK A, DECK B playback will begin. When the end of the tape has been reached on DECK B, automatic stop will be activated.

LISTENING TO THE RADIO

Manual tuning

1. Set the FUNCTION switch to TUNER.
2. Press the BAND button to select FM or AM.
3. Press the "+" or "-" TUNING button continuously until you are close to the desired frequency, then press it briefly until the desired frequency is displayed. Each time the button is pressed, the frequency changes in 0.05 MHz steps for FM and 9 kHz steps for AM.

To preset stations

This unit is capable of memorizing 16 stations in FM and AM, for a total of 32 stations.

1. Tune in the station to be preset as described in "Manual tuning".
2. Press the MEMORY button. "PROG." blinks.



3. Press two number buttons (for example: 09, 10, etc.) on the remote control to preset the station. "PROG." disappears.

- In this example, "FM 103.1 MHz" station is preset on number 9.
- When using the PRESET buttons on the front panel, press the ^ or v button to select the desired number, then press the MEMORY button.

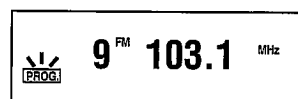

NOTE:

If the next step is not taken within 10 seconds while performing steps 2 - 3, "PROG." disappears and the preset operation is cancelled. Press the MEMORY button to continue.

4. Repeat the steps above to add more preset stations.

- When presetting a new station, the previously preset station on the same channel is cleared.
- The preset stations will be retained in the memory even if the unit is turned off.

If the memory contents are lost due to a power failure or other condition, preset the stations again.

Listening to preset stations

1. Set the FUNCTION switch to TUNER.
2. Press the BAND button to select FM or AM.
3. Press two number buttons on the remote control or the \wedge or \vee PRESET button on the front panel to select the desired number.

- To receive an FM stereo broadcast, make sure that "MONO" is not displayed. If "MONO" appears, press the MODE button to turn the "MONO" indication off. "STEREO" appears when an FM stereo broadcast is received.

- If the signal from an FM stereo station is weak and reception is poor, press the MODE button to change to monaural reception. ("STEREO" is replaced by "MONO" in the display.)

Changing the AM reception frequencies

It is not necessary to perform this procedure in the Australia and New Zealand.

1. Select the AM band.
2. Turn the power off.
3. While pressing the BAND button, press the POWER button.

522 - 1710 kHz (9 kHz steps) — 520 - 1710 kHz (10 kHz steps)

LISTENING TO VIDEO SOURCE

1. Make sure that the video equipment is connected to the VIDEO IN sockets.
2. Set the FUNCTION switch to VIDEO. "Ud" appears on the display.
3. Follow the instructions supplied with the video equipment.

BEFORE RECORDING AND DUBBING

Recording copyright material without permission of the copyright owners is usually an infringement. If you wish to re-record copyright material, permission from the copyright owner is necessary. SANYO does not approve of, and cannot be held responsible for, any unlawful use of this machine.

Accidental erasure prevention tabs (for protecting valuable recordings)

Accidental erasure can be prevented by breaking out the tabs on the end of the cassette tape (where the tape is not exposed) using a screwdriver or similar implement. If a tab is broken out in error and you wish to re-record the tape, simply block the tab hole using adhesive tape and the tape can be used for recording again.

Use DECK B for recording.

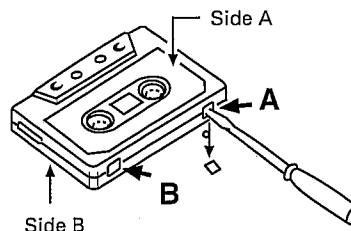

Break out tab A for side A.

Break out tab B for side B.

RECORDING COMPACT DISCS

Synchronous recording

This recording system starts disc play and cassette recording at the same time.

Preparation

Press the DECK B ■ STOP/▲ EJECT button, and insert a cassette into cassette compartment.

Recording from track No. 1

1. Set the FUNCTION switch to CD.
2. Load a disc into the CD player.
3. Press the ○ REC button. Recording will start at the beginning of track number 1.

4. Press the ■ STOP/▲ EJECT button to stop recording. When the end of the tape is reached, the disc play and tape recording will automatically stop at the same time.

Recording programmed tracks

1. Programme the materials in advance (as described under "PROGRAMMED PLAY").
2. Press the ○ REC button. Recording will start from the first programmed track.

RECORDING FROM THE TUNER OR VIDEO INPUT

1. Tune in the radio station to be recorded, or play a video source.
2. Load the cassette for recording.
3. Press the ○ REC button to start recording.
4. Press the ■ STOP/ ▲ EJECT button to stop recording. When the end of the tape has been reached, automatic stop will be activated.

When beat interference is heard

A high-pitched noise called "beat" is sometimes heard during the recording of radio broadcasts. In cases like this, set the DUBBING/BEAT CANCEL button to the position that reduces the level of the beat noise.

TAPE DUBBING (DECK A to DECK B)

1. Load the playback cassette into DECK A and a blank cassette into DECK B.
2. Set the FUNCTION switch to TAPE.
3. Set the cassette in DECK A to the point where recording will begin.
4. Select the dubbing speed with the DUBBING/BEAT CANCEL button.
NOR:
For dubbing while monitoring at normal speed.
HIGH:
For dubbing the tape at high speed (twice normal speed).

5. Press the ■ PAUSE button of DECK B.
6. Press the ○ REC button of DECK B.
7. Press the ▷ PLAY button of DECK A to start dubbing.
8. To stop dubbing, press both ■ STOP/ ▲ EJECT buttons.

Automatic stop during dubbing

If DECK B stops automatically, DECK A continues playback mode at normal speed.

If DECK A stops automatically, DECK B erases the tape to the end.

- Do not change the dubbing speed during the dubbing operation.

MAINTENANCE

Cleaning the cabinet

Use a clean soft cloth moistened with plain lukewarm water and wrung dry. Never use benzol, benzene or other strong chemical cleaners since these could damage the finish of your unit. It is important that no liquid reaches the inside of the unit.

Cleaning the cassette section

For continued high performance from the cassette section, periodically clean the heads, pinch rollers and capstans whenever an accumulation of dust and red-brown oxide particles is noticed.

To do this, press both ■ STOP/ ▲ EJECT buttons. Remove any cassettes still in the cassette compartments. Carefully rub each head (4, 5, 8), pinch rollers (3, 7) and capstans (2, 6) with a cotton swab (1) moistened with Isopropyl alcohol or special head-cleaning fluid.

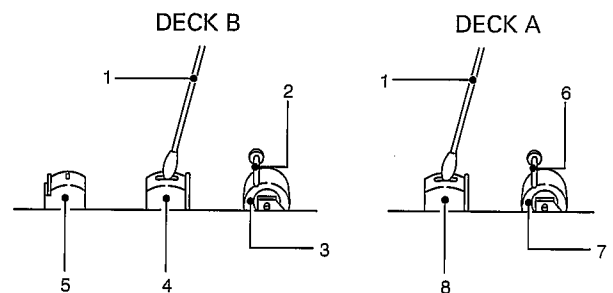

SPECIFICATIONS

Tuner section

Reception frequency:
FM : 87.5 - 108 MHz
AM : 522 - 1710 kHz

CD player section

Channels:
2-channel stereo
Sampling frequency:
44.1 kHz
Pick-up:
Optical 3-beam semiconductor laser
Laser output:
0.6 mW (Continuous wave max.)
Wave length:
790 nm
Frequency response:
20 Hz to 20 kHz
Wow/flutter:
Below measurable limits

Cassette deck section

Track system:
4-track, 2-channel stereo
Frequency response:
80 Hz to 13.5 kHz
Signal-to-noise ratio:
50 dB
Wow/flutter:
0.15% (WRMS)
Fast forward/rewind time:
Approx. 110 sec. (C-60)

Amplifier section

Output power:
5 W x 2 (at 4 ohms, 10% distortion)
Bass expander:
+ 8dB (100Hz)
Inputs:
VIDEO: 300mV/50k ohms
Outputs:
SPEAKERS: 4 ohms
PHONES: 8 - 32 ohms
Power requirements:
AC 230-240 V, 50 Hz
Power consumption:
38 W
Dimensions:
270(W) x 283(H) x 211(D) mm
Weight:
3.7 kg

Speaker systems

Type:
2 way bass reflex
Unit used:
Woofer: 12 cm cone type
Tweeter: 2 cm piezoelectric
Maximum power-handling capacity:
10 W (peak)
Nominal impedance:
4 ohms
Dimensions:
180(W) x 285(H) x 211(D) mm
Weight:
1.4 kg (per speaker)

Specifications subject to change without notice.



SANYO Electric Co., Ltd.
Printed in Malaysia