

# SANYO

INSTRUCTION MANUAL

Micro Component Systems

DCDA70  
DCDA80

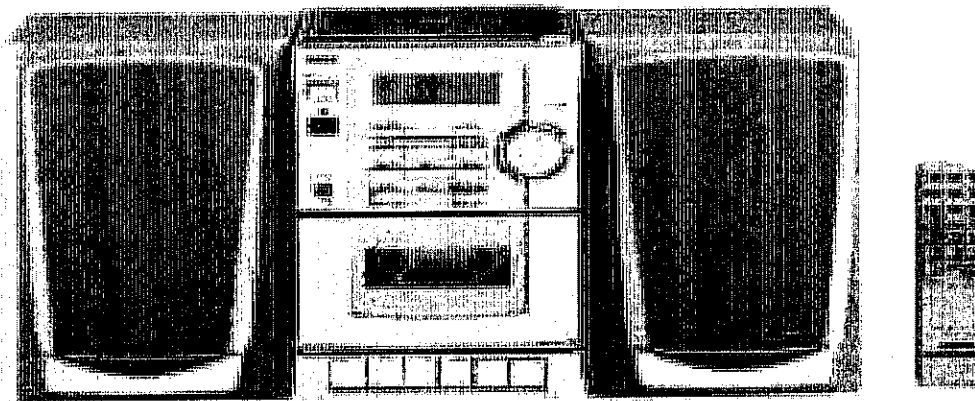

# PRECAUTIONS

CAUTION - INVISIBLE LASER RADIATION WHEN OPEN AND INTERLOCKS DEFEATED. AVOID EXPOSURE TO BEAM.  
 ADVARSEL - USYNLIG LASER STRÅLING VED ÅBNING, NÅR SIKKERHEDSAFBRYDERE ER UDE AF FUNKTION, UNDGÅ UDSÆTTELSE FOR STRÅLING.  
 VARNING - OSYNLIG LASER STRÅLNING NÅR DENNA DEL ÄR ÖPPNAD OCH SPÄRR ÄR URKOPPLAD. STRÅLEN ÄR FARLIG.  
 VORSICHT - UNSICHTBARE LASERSTRAHLUNG TRIT AUS, WENN DECKEL GEÖFFNET UND WENN SICHERHEITVERRIEGELUNG ÜBERBRÜCKT IST. NICHT, DEM STRAHL AUSSETZEN.  
 VARO - AVATTAESSA JA SUOJALUKITUS OHITETTAESSA OLET ALTTIINA NÄKYMÄTTÖMÄLLE LASERSÄTEILYLLE. ÄLÄ KATSO SÄTEESEEN.

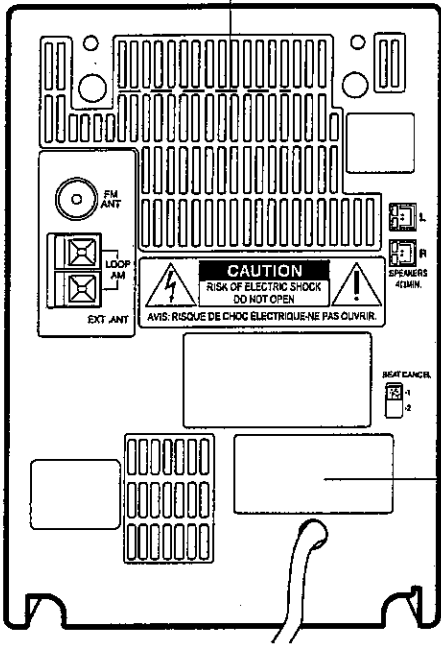

CLASS 1 LASER PRODUCT  
 LUOKAN 1 LASERLAITE  
 KLASS 1 LASERAPPARAT

**CAUTION - USE OF CONTROLS OR ADJUSTMENTS OR PERFORMANCE OF PROCEDURES OTHER THAN THOSE SPECIFIED IN THE OPERATING INSTRUCTIONS MAY RESULT IN HAZARDOUS RADIATION EXPOSURE. THE COMPACT DISC PLAYER SHOULD NOT BE ADJUSTED OR REPAIRED BY ANYONE EXCEPT PROPERLY QUALIFIED PERSONNEL.**

- The apparatus shall not be exposed to dripping or splashing.
- Do not use where there are extremes of temperature (below 5°C or exceeding 35°C) or where direct sunlight may strike it.
- Because of the CD player's extremely low noise and wide dynamic range, there might be a tendency to set the volume on the amplifier unnecessarily high. Doing so may produce an excessively large output from the amplifier which could damage your speakers.
- Sudden changes in the ambient temperature may cause condensation to form on the optical lens inside the unit. If this happens, take out the disc, leave the unit for about 1 hour, and then proceed to operate.
- The system's speakers use powerful magnets. Do not place timepieces, credit cards, cassette tapes or video tapes, etc. near the speakers.
- Do not install this equipment in a confined space, such as a book case or built in cabinet.

# CONNECTIONS

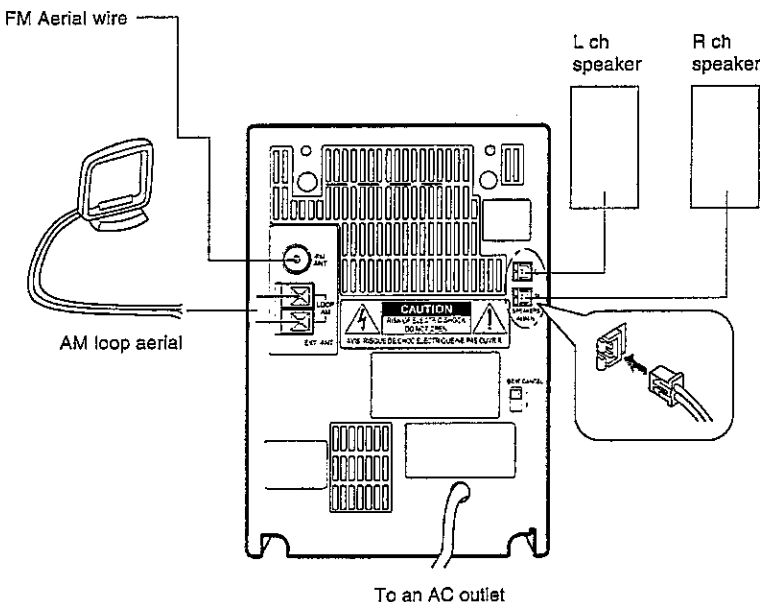

**Note:**

- Do not connect the mains lead to an AC outlet until all connections have been made.
- The system is not completely disconnected from the mains when the power button is set to the OFF position.

**Speakers**

Connect the connector of the left speaker lead to the "L" SPEAKERS socket and the connector of the right speaker lead to the "R" socket. If you have difficulty inserting the speaker lead connector, turn it over and reinsert it.

**Aerials**

FM indoor aerial is sufficient to receive broadcasts. Extend the aerial wire as straight as possible and, while listening to the sound from the system, secure it in a position which yields minimal distortion and noise.

### AM loop aerial

Assemble the loop aerial as shown in Figure. Unwind the aerial wires, then connect them to the AM LOOP terminals. Place the loop aerial in a position which yields the best AM reception, or attach it to a wall or other surface as shown in Figure.

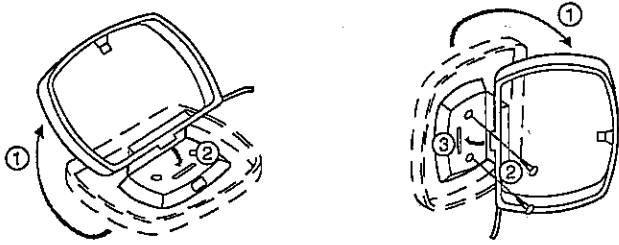

Screws (not supplied)

### Note:

To minimize noise, the speaker, mains and any other leads should not come close to the indoor or external aerial lead and AM loop aerial. Do not place the aerial leads close to the system.

### Headphones

Connect stereo headphones (not supplied) to the PHONES socket for monitoring or for private listening. The speakers are automatically disconnected when headphones are connected.

## CONTROLS

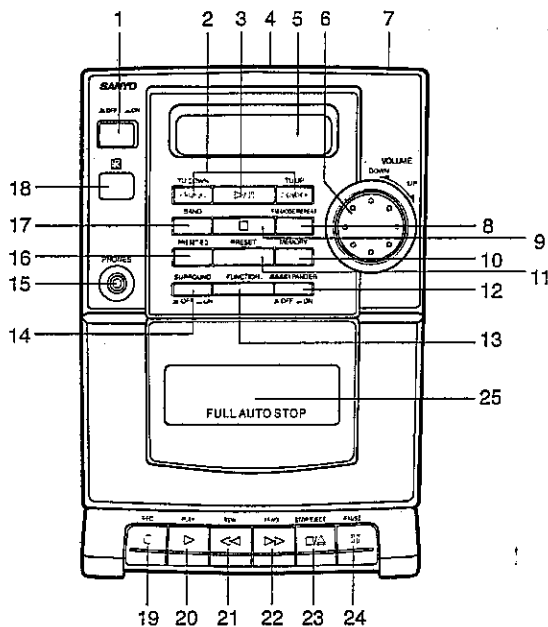

### CD player/Tuner/General

1. Power button ( ■ OFF, — ON)
2. Tuning down/Skip/Search/Tuning up buttons (TU DOWN ◀◀/▶▶, TU UP ▶▶▶▶)
3. Play button (▶/||)
4. CD compartment
5. Display
6. Volume control (VOLUME DOWN/UP)
7. CD compartment opening button (CD OPEN)
8. FM mode/Repeat button (FM MODE/REPEAT)
9. Stop/clear button (■)
10. Memory button (MEMORY)
11. Preset button (PRESET)
12. Bass expander button (BASSXPANDER)
13. Function button (FUNCTION)
14. Surround button (SURROUND)
15. Headphones socket (PHONES)
16. Preset equalizer button (PRESET-EQ)
17. Radio band button (BAND)
18. Remote sensor (IR)

### Cassette deck

19. Record button (REC)
20. Play button (PLAY)
21. Rewind button (REW)
22. Fast forward button (FFWD)
23. Stop/Eject button (STOP/EJECT)
24. Pause button (PAUSE)
25. Cassette holder

## REMOTE CONTROL

### Controls

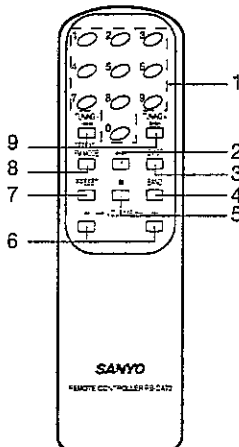

1. Number buttons (1-9, 0)
2. Play/Pause button (▶/||)
3. Memory button (MEMORY)
4. Radio band button (BAND)
5. Stop/Clear button (■)
6. Volume buttons (VOLUME +, -)
7. Preset button (PRESET)
8. Repeat/FM mode button (REPEAT/ FM MODE)
9. Tuning/Skip/Search buttons (TUNING - ◀◀, TUNING + ▶▶▶)

### Number buttons (1-9, 0)

These buttons are used to select the track numbers on a disc or preset radio stations.

If the function is "CD", the buttons select the track numbers on a disc.

If the function is "TUNER", the buttons select preset radio stations.

With any other function, the buttons will not function.

- Two buttons must always be pressed.

Example:

To select No. 3, press 0, then 3.

To select No. 10, press 1, then 0.

To select No. 25, press 2, then 5.

## Inserting batteries

1

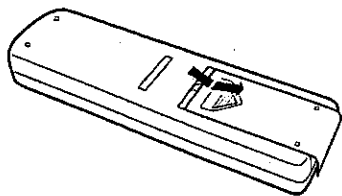

2

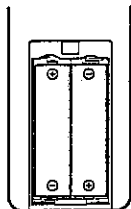

Two R03/AAA batteries  
(not supplied)

### Note:

Always remove batteries if the remote control is not to be used for a month or more. Batteries left in the unit may leak and cause damage.

## Remote control range

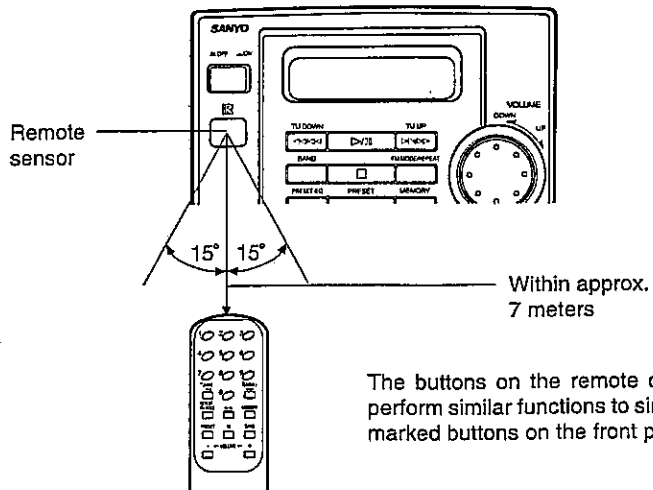

# GENERAL OPERATION

### Adjusting the volume

Turn the VOLUME control, (or press the + or - VOLUME button on the remote control). The volume level appears on the display. (VOL 0 ~ VOL 24.)

### Surround sound button

Press the SURROUND button to = ON. A "Wide" effect is created.

### Bass expander button

Press the BASSPANDER button to = ON to enhance the bass sound.

### Selecting the sound mode

Press the PRESET-EQ button to select the sound mode matching the music to be listened to.

POP: Pops, etc.

ROCK: Rock music, etc.

JAZZ: Jazz, etc.

CLASSIC: Classical music, etc.

### WHAT TO DO IF ...

If the operation of the unit or display is not normal.

1. Disconnect the mains lead.
2. Wait for at least 30 seconds.
3. Connect the mains lead.
4. Operate the unit.

# CD PLAY

Use compact discs bearing the symbol shown. In addition to conventional 12 cm CDs, this system can be used to play 8 cm CDs without an adapter.



1. Press the FUNCTION button to select "CD" function.
2. Press the CD OPEN button. The CD compartment opens.
3. Place the disc with the label facing up on the disc turntable (Place only one disc at a time.)
4. Press the CD compartment lid (PUSH TO CLOSE portion) to close it. The total number of tracks and total playing time on the disc appear.

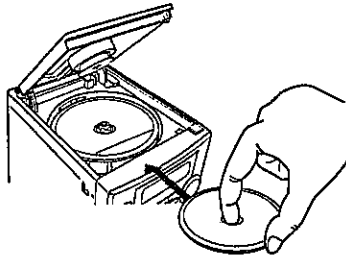

#### Note:

If the disc is loaded with the label facing downward, or if a badly scratched disc is loaded, "Cd" appears. If this occurs, load the disc correctly or replace the damaged disc.

5. Press the ►/|| button. Play starts from the first track. The current track number and elapsed playing time are displayed.



6. Press the ■ button to end disc play. When the last track has been played, the player stops automatically.

#### Note:

Always press the ■ button and wait for the disc to stop rotating before opening the CD compartment.

### Notes on handling compact discs

- Do not expose the disc to direct sunlight, high humidity or high temperatures for extended periods of time.
- Discs should be returned to their cases after use.
- Do not apply paper or write anything on the disc surface.
- Handle the disc by its edge. Do not touch the playing surface (glossy side).
- Fingerprints and dust should be carefully wiped off the playing surface of the disc with a soft cloth. Wipe in a straight motion from the centre to the outside of the disc.
- Never use chemicals such as record cleaning sprays, antistatic sprays or fluids, benzene or thinner to clean compact discs.

### To start play from the desired track

Select the track by using the ►/|| or ◀/◀◀ button, then press the ►/|| button.

#### Using the remote control

Press two number buttons within 2 seconds. (Example: press 0, then 3.)

### Temporarily stopping play

Press the ►/|| button. "►" blinks on the display. To resume play, press the button again.

### Skip play

To skip to track 6 while track 3 is playing, press the ►/|| button repeatedly until "6" appears (in the track section) on the display. To skip back to track 3 while track 6 is playing, press the ◀/◀◀ button repeatedly until "3" appears.

- The number buttons on the remote control can also be used for skip play. To skip to track 6 while one track is playing, press 0, then 6.

### Search (forward/reverse)

If the ►/|| or ◀/◀◀ button is pressed during play, the player will search at high speed in the forward or reverse direction while the button is being pressed. When the button is released, normal play will continue.

### Repeat play

Press the REPEAT button before or during play. The player will play all the tracks or all the programmed tracks repeatedly. "REP" appears. To cancel repeat play, press the REPEAT button again. "REP" disappears.

## PROGRAMMED PLAY

Up to 20 tracks on a disc can be programmed for play in any order.

- First, select "CD" function and load a disc that you want to programme.
- The tracks must be programmed in the stop mode.
- The same track can be programmed more than once.

1. Press the MEMORY button.

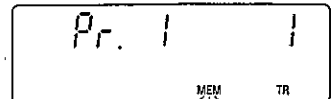

2. Select a track by using the ►/|| or ◀/◀◀ button.

- The number buttons on the remote control can also be used.

3. Press the MEMORY button.

4. Repeat steps 2-3 to programme additional tracks.

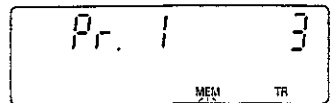

5. Press the ►/|| button to start programmed play.

When all programmed tracks have played, the player stops automatically.

- The programme contents are retained in memory.

- Any attempt to programme more than 20 tracks will result in "FULL" being displayed and discontinuation of the programming.

- The programme contents are retained even if the function selection is changed. After selecting "CD" function, press the MEMORY button. The programmed contents appear.

- To cancel programmed play, press the ■ button twice.

### Checking the programme

Each time the MEMORY button is pressed in the stop mode, the programmed details sequentially appear on the display.

### Changing a programme

To add a new track to a programme:

1. In the stop mode, press the MEMORY button repeatedly until "- - -" is displayed.
2. Select a track as explained above.
3. Press the MEMORY button.

#### To change a track:

1. In the stop mode, press the MEMORY button repeatedly until the track number to be replaced is displayed.
2. Select a track as explained above.
3. Press the MEMORY button.

#### Note:

Programmed details cannot be partially deleted or inserted.

## LISTENING TO TAPES

1. Press the **FUNCTION** button to select "TAPE".
2. Press the **STOP/EJECT** button to open the cassette holder.
3. Load the cassette.  
After loading the cassette, push the cassette holder back into position.
4. Press the **PLAY** button to begin playback.
5. Press the **STOP/EJECT** button to stop playback at any time. Press it again to remove the cassette.  
When the end of the tape has been reached, automatic stop will be activated.

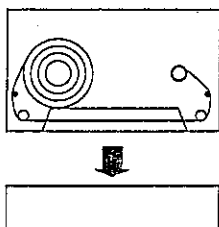

Note:

- Use the normal tape (TYPE 1).
- Endless tapes cannot be used.
- Do not use C-100 (or longer) tapes. They may jam in the mechanism.

### Pause

Press the **PAUSE** button to temporarily stop playback or recording. Press it again to resume operation.

### Fast forward and rewind

Press the **FFWD** or **REW** button. When the desired location has been reached, press the **STOP/EJECT** button.

## LISTENING TO THE RADIO

### Before use

When the unit is shipped from the factory, its AM frequency band is set as "522 - 1710 kHz (in 9 kHz steps)".

If your local AM broadcast system is organized in 10 kHz steps, change the frequency band to "520 - 1710 kHz (in 10 kHz steps)" as follows.

1. Press the power button to OFF.
2. While pressing the **BAND** button on the front panel, press the power button to turn the power on.

To return the original setting, repeat steps above.

### Automatic/Manual tuning

1. Press the function button to select **TUNER**. The radio frequency appears.
2. Select the desired radio band with the **BAND** button.
3. Automatic tuning  
Press the **TU UP** or **TU DOWN** button for at least 1 second to tune in a station. The unit will scan up or down the band and receive the next receivable station. Press the button again to continue.
  - The **▶▶** or **◀◀** button on the remote control can also be used.

#### Manual tuning

Press the **TU UP** or **TU DOWN** button briefly until desired frequency is displayed.

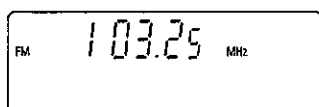

### To preset stations

Up to 20 stations for FM band, 12 stations for AM band can be preset.

1. Tune in the station to be preset as described above.
2. Press the **MEMORY** button.

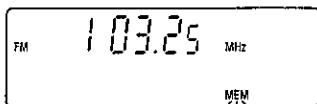

3. While "MEM" is blinking, press the **PRESET** button to select the channel to be preset.

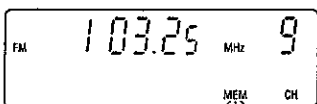

4. While "MEM" is blinking, press the **MEMORY** button. "MEM" disappears.
  - In this example, "103.25 MHz" FM station is preset on FM channel 9.
  - The number buttons on the remote control can also be used. In this example, press 0, then 9 after the step 2 above.

5. Repeat steps above to add more preset stations.

- When presetting a new station, the previous preset station is cleared.

### Listening to preset stations

1. Press the **BAND** button to select FM, AM.
2. Press the **PRESET** button on the front panel (or **PRESET** button on the remote control) to select the desired channel number.
  - The number buttons on the remote control can also be used. Press two number buttons within 2 seconds.

### Preset scan tuning

1. Select "TUNER" function and select the band.
2. Press the **PRESET** button for at least 1 second. "PS" blinks on the display. Each of the preset stations is tuned in for 5 seconds.
3. When the desired station has been tuned in, press the **PRESET** button again to keep the reception locked at that station.

### To receive FM stereo broadcasts

Make sure that "MONO" is not displayed. If "MONO" appears, press the **FM MODE** button to turn the "MONO" indication off.

"ST" appears when an FM stereo broadcast is received.

- If the signal from an FM stereo station is weak and reception is poor, press the **FM MODE** button to change to the MONO mode. The reception may be improved, but the sound will be monaural.

# RECORDING

Recording copyright material without permission of the copyright owners is usually an infringement. If you wish to re-record copyright material, permission from the copyright owner is necessary. SANYO does not approve of, and cannot be held responsible for, any unlawful use of this machine.

## Recording compact discs (Synchronous recording)

1. Load a blank cassette.
2. Select "CD" function.
3. Load the disc to be recorded.
  - Select the track number if required.
  - For programmed recording, programme the material in advance (as described under "PROGRAMMED PLAY").
4. Press the REC button. The PLAY button is engaged simultaneously and CD recording starts.
  - When you want to record music as you listen, press the REC button. Recording starts automatically from the beginning of the track.
5. Press the STOP/EJECT button to stop recording. When the end of the tape is reached, the CD player and deck stop automatically.

## Recording from the tuner

1. Load a blank cassette.
2. Tune in the radio station to be recorded.
3. Press the REC button to start recording.
4. Press the STOP/EJECT button to stop recording.

## When beat is heard

Beat (a high-pitched noise) may sometimes be heard during the recording of radio broadcasts. If this occurs, set the BEAT CANCEL switch (rear of the unit) to the position that reduces the level of the beat noise.

## Safeguards against accidental erasure

Accidental erasure can be prevented by breaking out the tabs on the end of the cassette taps (where the tape is not exposed) using a screwdriver or similar implement.

If a tab is broken out in error and you wish to re-record the tape, simply block the tab hole using adhesive tape and the tape can be used for recording again.

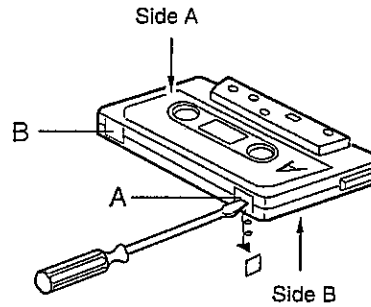

Break out tab A for side A.  
Break out tab B for side B.

# MAINTENANCE

## Cleaning the tape heads

To ensure continued high performance, use cotton swab to clean the heads, pinch roller and capstan of the deck after about every 10 hours of use. If the dirt persists, soak the swab in a little methylated spirit or head cleaning fluid and then clean.

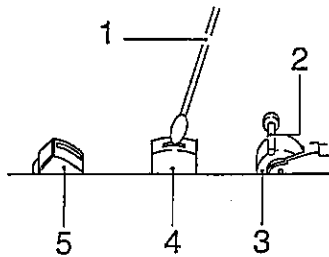

1. Cotton swab
2. Capstan
3. Pinch roller
- 4, 5. Head

## Cleaning the CD player lens

The lens should never be touched. If dust is on the lens, blow it off using a camera lens blower. (Consult your dealer.)

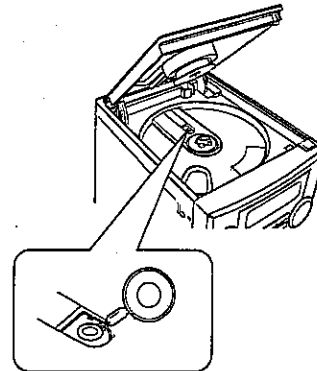

## Cleaning the unit

Clean the outside of the unit with a clean soft cloth, moistened with lukewarm water. Do not use benzene, thinner or alcohol since they will mar the finish of the surfaces.

# SPECIFICATIONS

## Tuner

### Reception frequency:

FM: 87.5 - 108 MHz

AM: 522 - 1710 kHz (9 kHz step)

520 - 1710 kHz (10 kHz step)

## CD player

### Channels:

2-channel stereo

### Sampling frequency:

44.1 kHz

### Pick-up:

Optical 3-beam semiconductor laser

### Laser output:

0.6 mW (Continuous wave max.)

### Wave length:

790 nm

### Wow/flutter:

Below measurable limits

## Cassette deck

### Track system:

4-track, 2-channel stereo

### Frequency response:

80 Hz to 15 kHz

### Signal-to-noise ratio:

40 dB

### Wow/flutter:

0.15% (WRMS)

### Fast forward/rewind time:

Approx. 110 sec. (C-60)

## General

### Output power:

4W x 2 (at 4 ohms, 10% distortion)

### Outputs:

SPEAKERS: 4 ohms

PHONES: 8 - 32 ohms

### Power requirements:

AC 230 - 240 V, 50 Hz

### Power consumption:

19 W

### Dimensions:

140(W) x 210(H) x 200(D) mm

### Weight:

2.2 kg

## Speaker systems

### Type:

Full range bass reflex

### Unit used:

10 cm cone type

### Maximum power-handling capacity:

6 W (peak)

### Nominal impedance:

4 ohms

### Dimensions:

140(W) x 210(H) x 184(D) mm

### Weight:

1.2 kg (per speaker)

Specifications subject to change without notice.

The SANYO logo consists of the word "SANYO" in a bold, sans-serif font. The letter "A" is stylized with three vertical lines of varying heights passing through it, creating a distinctive graphic element.