

SANYO

INSTRUCTION MANUAL

DC-F380

Mini Component System

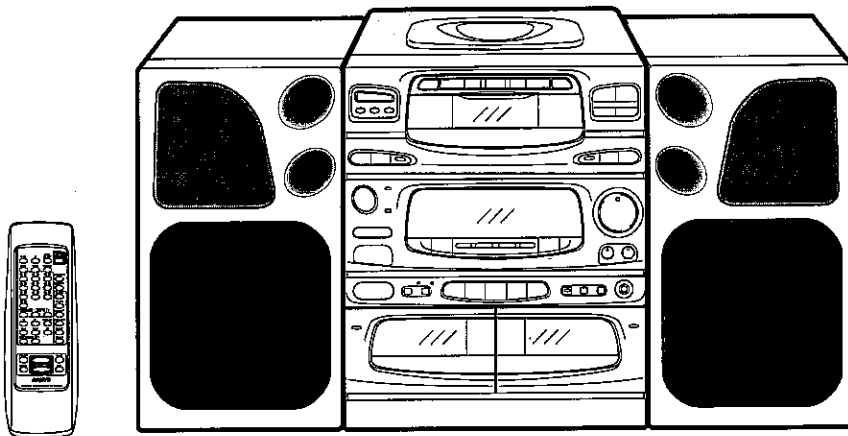

CAUTION - USE OF CONTROLS OR ADJUSTMENTS OR PERFORMANCE OF PROCEDURES OTHER THAN THOSE SPECIFIED IN THE OPERATING INSTRUCTIONS MAY RESULT IN HAZARDOUS RADIATION EXPOSURE.

THE COMPACT DISC PLAYER SHOULD NOT BE ADJUSTED OR REPAIRED BY ANYONE EXCEPT PROPERLY QUALIFIED PERSONNEL.

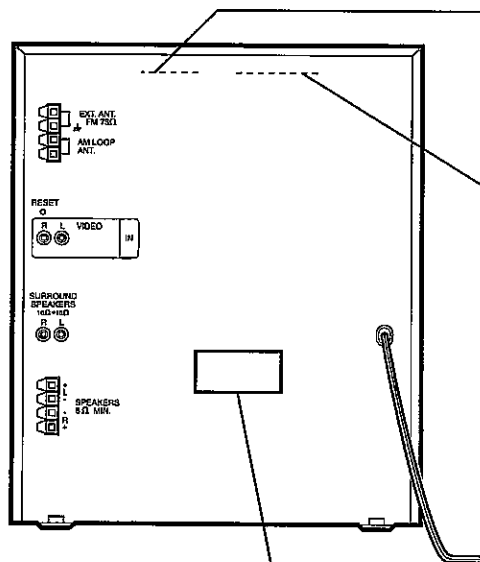

CAUTION - INVISIBLE LASER RADIATION WHEN OPEN AND INTERLOCKS DEFEATED. AVOID EXPOSURE TO BEAM.

ADVARSEL - USYNLIG LASER STRÅLING VED ÅBNING, NÅR SIKKERHEDSAFBRYDERE ER UDE AF FUNKTION, UNDGÅ UDSÆTTELSE FOR STRÅLING.

VARNING - OSYNLIG LASER STRÅLNING NÅR DENNA DEL ÄR ÖPPNAD OCH SPÄRR ÄR URKOPPLAD. STRÅLEN ÄR FARLIG.

VORSICHT - UNSICHTBARE LASERSTRAHLUNG TRITT AUS, WENN DECKEL GEÖFFNET UND WENN SICHERHEITSVERRIEGELUNG ÜBERBRÜCKT IST. NICHT, DEM STRAHL AUSSETZEN.

VARO - AVATTAESSA JA SUOJALUKITUS OHITETTAESSA OLET ALTTIINA NÄKYMÄTTÖMÄLLE LASERSÄTEILYLLE. ÄLÄ KATSO SÄTEESEEN.

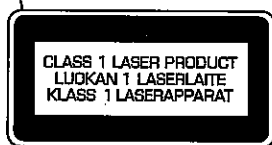

PRECAUTIONS

- If water should enter the unit, electrical shock or malfunction may result. Always use it in a place where there is low humidity and little dust.
- Do not use where there are extremes of temperature (below 5°C or exceeding 35°C) or where direct sunlight may strike it.
- Because of the CD player's extremely low noise and wide dynamic range, there might be a tendency to set the volume on the amplifier unnecessarily high. Doing so may produce an excessively large output from the amplifier which could damage your speakers.
- Sudden changes in the ambient temperature may cause condensation to form on the optical lens inside the unit.

If this happens, take out the disc, leave the unit for about 1 hour, and then proceed to operate.

- **When carrying the unit, be sure to remove any discs which may be inside and turn the power off. The **STANDBY** indicator lights. Then unplug the mains lead from the AC outlet. Carrying the unit with any discs inside may damage the discs and/or the unit.**
- The system's speakers use powerful magnets. Do not place timepieces, credit cards, cassette tapes or video tapes, etc. near the speakers.

Do not install this equipment in a confined space, such as a book case or built-in cabinet.

CONNECTIONS

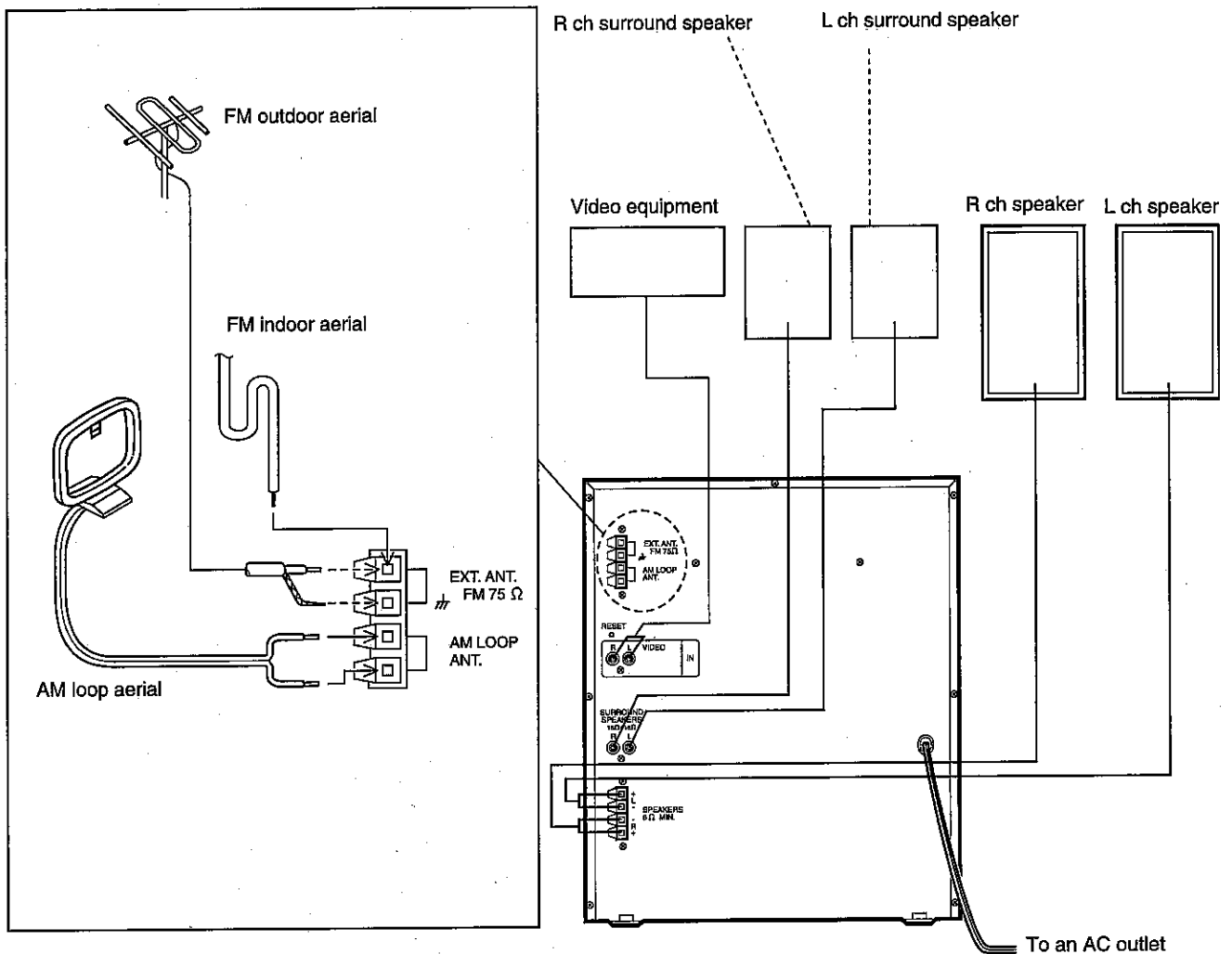

Note:

Do not connect the mains lead to an AC outlet until all connections have been made.

When the unit is first connected, the display switches automatically to the demonstration mode. To cancel this mode, turn the power on or press the DISPLAY button.

The system is not disconnected from the mains unless the mains lead is unplugged from the AC outlet.

Speakers

When connecting the speakers, make sure that (+) and (-) polarities are matched properly. Otherwise, the sound may appear to be lacking in the bass range and in stability. Connect the speaker wire with the stripe to the red terminal (+) and the other wire to the black terminal (-).

Attaching and detaching the speaker grille

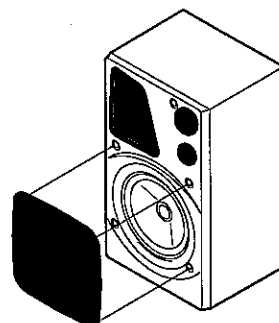

FM aerial

The FM indoor aerial is sufficient to receive most local FM broadcasts and should be connected to the EXT. ANT. terminal. Extend the aerial wire as straight as possible and, while listening to the sound from the system, secure it in a position which yields minimal distortion and noise.

In fringe areas or where reception is distorted or noisy, an FM outdoor aerial (not supplied) should be connected instead of the indoor aerial. The terminals will accept 75-ohm coaxial cable. Consult your dealer.

AM loop aerial

Assemble the loop aerial as shown in figure.

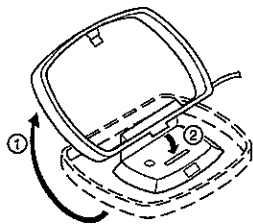

Unwind the aerial wires, then connect them to the AM LOOP ANT. terminals. Place the loop aerial in a position which yields the best AM reception, or attach it to a wall or other surface as shown in figure.

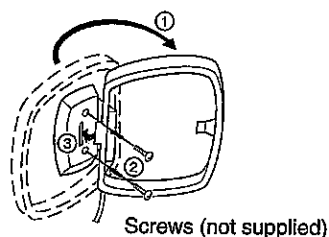

Note:

To minimize noise, the speaker, mains and any other leads should not come close to the FM indoor or outdoor aerial lead and AM loop aerial. Do not place the aerial leads close to the system.

Video equipment

Connect leads (not supplied) from the audio output sockets of a video equipment to the VIDEO IN sockets.

Headphones

Connect stereo headphones (not supplied) to the PHONES socket for monitoring or for private listening. The speakers are automatically disconnected when headphones are connected.

Surround speakers

Connect only surround speakers (16 ohms impedance, not supplied) to the SURROUND SPEAKERS sockets.

Example setting

Note:

- The surround effect will not activate with monaural sources.
- Be sure to connect surround speakers to both L and R sockets.

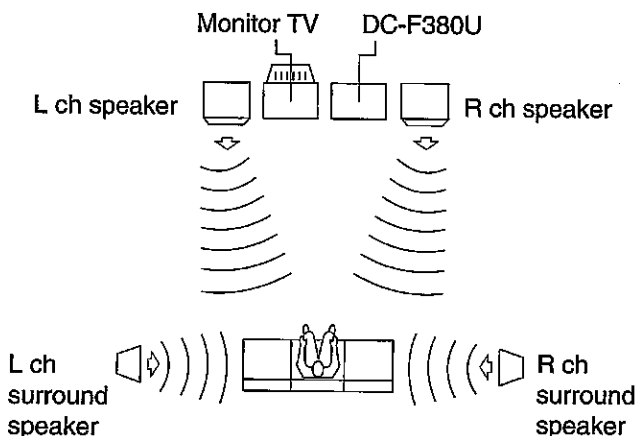

PLEASE NOTE

IF YOU WISH TO USE THIS DC-F380 COMPACT STEREO WITH A SANYO HT-D47 SURROUND PROCESSOR, YOU MUST CHECK THE COMPATIBILITY. ONLY HT-D47 UNITS MARKED "AU2" ON THE RATING LABEL ARE COMPATIBLE FOR USE WITH THIS PRODUCT.

IF YOU HAVE ANY QUERIES, PLEASE PHONE SANYO AUSTRALIA PTY LTD; PHONE 02-763-3900 / SANYO NEW ZEALAND LTD; DIRECTLY ON FREE PHONE 0508-425-425

CONTROLS

CD player/Tuner section

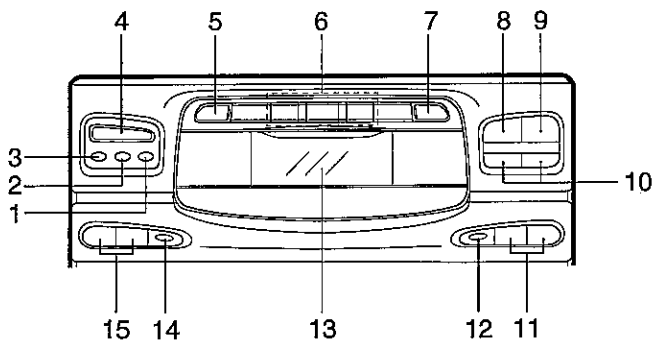

1. Repeat button (REPEAT)
2. Edit button (EDIT)
3. Memory button (MEMORY)
4. Computer recording button (COMPUTER REC)
5. Disc check button (DISC CHECK)
6. Disc select buttons/indicators (DISC 1/DISC 2/DISC 3)
7. Disc tray open/close button (OPEN/CLOSE)
8. Stop button (STOP)
9. Play/Pause button (PLAY/PAUSE)
10. Skip/Search buttons (SKIP/SEARCH)
11. Preset tuning buttons (PRESET)
12. Band select button (BAND)
13. Disc trays (DISC 1/DISC 2/DISC 3) (inside the door)
14. FM mode select button (FM MODE)
15. Tuning buttons (TUNING)

Cassette deck section

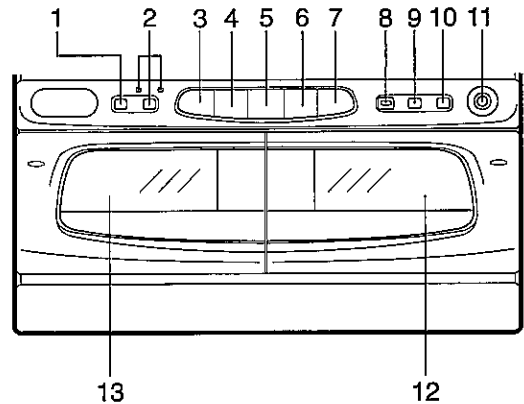

1. Reverse mode select button (REVERSE MODE)
2. Deck select button/indicators (A DECK B)
3. Fast wind button (◀◀)
4. Reverse play button (◀)
5. Stop button (■)
6. Forward play button (▶)
7. Fast wind button (▶▶)
8. Record/Record pause button/indicator (REC PAUSE)
9. High-speed dubbing button (DUBBING HIGH)
10. Dolby NR button (DOLBY NR)
11. Headphones socket (PHONES)
12. Deck B cassette holder
13. Deck A cassette holder

Amplifier section

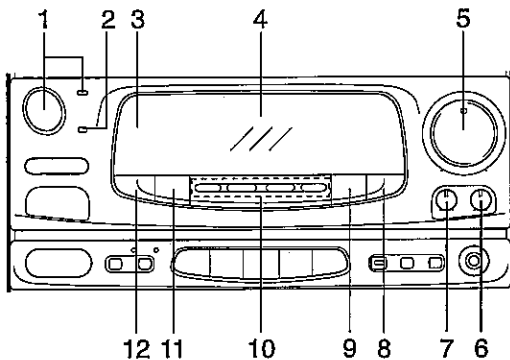

1. Power button/Standby indicator (POWER/STANDBY)
2. Display button (DISPLAY)
3. Remote sensor (IR)
4. Display
5. Volume control (VOLUME)
6. Balance control (BALANCE)
7. Sound quality control (SPECTRUM CONTROL)
8. Bass expander button (BASSXPANDER)
9. Function button (FUNCTION)
10. Function indicators (CD/TAPE/TUNER/VIDEO)
11. Digital signal processor surround button (DSP SURROUND)
12. Sound preset button (SOUND PRESET)

REMOTE CONTROL

Controls

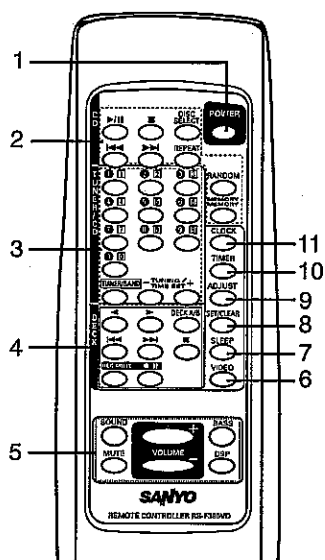

1. Power button (POWER)
2. CD player controls
 - ▶/⏸ : Play/Pause button
 - : Stop button
 - DISC SELECT: Disc select button
 - ◀◀, ▶▶ : Skip/Search buttons
 - REPEAT: Repeat button
 - RANDOM: Random play button
 - MEMORY: Memory button
(This button can also be used as a tuner memory button.)
3. Tuner/CD controls
 - 1 - 9, 0: Number buttons
 - TUNER/BAND: Tuner function/Band select button
 - TUNING/TIME SET: Tuning/Time set buttons
4. Deck controls
 - ◀ : Reverse play button
 - ▶ : Forward play button
 - DECK A/B: Deck select button
 - ◀◀, ▶▶ : Fast wind buttons
 - : Stop button
 - REC MUTE: Record muting button
 - /⏸ : Record/Record pause button
5. Amplifier controls
 - SOUND: Sound preset button
 - MUTE: Audio muting button
 - VOLUME: Volume buttons
 - BASS: Bass expander button
 - DSP: Digital signal processor surround button
6. Video function button (VIDEO)
7. Sleep timer button (SLEEP)
8. Set/Clear button (SET/CLEAR)
9. Adjust button (ADJUST)
10. On/Off timer button (TIMER)
11. Clock button (CLOCK)

Number buttons (1 - 9, 0)

These buttons are used to select the track numbers on a disc or preset radio stations.

If the function is "CD", the buttons select the track numbers on a disc.

If the function is "TUNER", the buttons select preset radio stations.

With any other function, the buttons will not function.

- Two buttons must always be pressed.

Example:

To select No. 3, press 0, then 3.

To select No. 10, press 1, then 0.

To select No. 25, press 2, then 5.

Inserting batteries

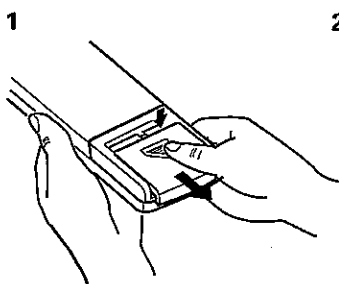

2

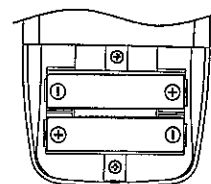

Two AA/R6/SUM-3 batteries
(not supplied)

Note:

Always remove batteries if the remote control is not to be used for a month or more. Batteries left in the unit may leak and cause damage.

Remote control range

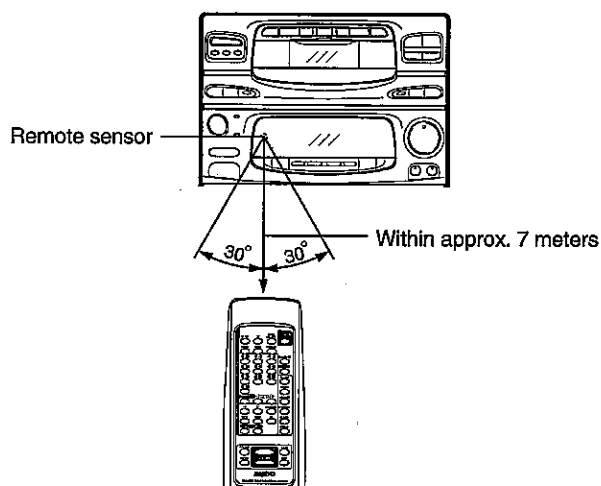

The buttons on the remote control perform similar functions to similarly marked buttons on the front panel. See "REMOTE CONTROL OPERATION" for more details.

ADJUSTING THE CLOCK

Using the remote control

Example: To set "PM 7:30",

1. Press the CLOCK button. The clock display appears.
 - After connecting the mains lead for the first time, when you press the CLOCK button, the clock display blinks.
2. Press the ADJUST button.



The hours display blinks.

3. Press the + or – TUNING/TIME SET button to set the "hours."

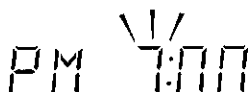

4. Press the ADJUST button.

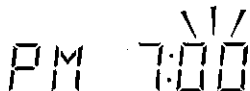

The minutes display blinks.

5. Press the + or – TUNING/TIME SET button to set the "minutes."

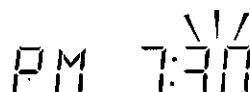

6. Press the ADJUST button. The clock starts.



- The time can be set accurately by pressing the ADJUST button when a time signal is heard.
- These operations can be done, even if the power is off.
- To display the clock during operation, press the CLOCK button. Press it again to return to the original display.
- The clock operation and memory are backed up even with a power failure lasting 30 seconds or less. When a power failure lasts for more than 30 seconds, the memory contents will be retained for several days, but the clock display will blink. Reset the time when the display blinks because of a power failure.

BEFORE OPERATION

Turning the power on and off

Press the POWER button. The indicators and displays light and the STANDBY indicator goes out. (After connecting the mains lead, when you press the POWER button for the first time, the volume reset feature automatically reduces the volume level.)

To turn off the power, press the POWER button again. The STANDBY indicator lights. The clock display remains lit.

- When the mains lead is connected to the AC outlet, the STANDBY indicator lights and the unit will respond to commands from the remote control.

Smart start function

If the following buttons are pressed when the power is turned off, the unit turns on automatically and the selected function is set.

CD player section	PLAY/PAUSE, DISC 1, DISC 2, DISC 3, OPEN/CLOSE
Tuner section	BAND
Cassette section	▶, ◀

Graphic display

Below indication appears on the display for a few seconds when corresponding operation button is pressed.

▶, ◀, ▶▶, ◀◀, II, ■, ●, ○, A, B, AL, 1, 2, 99

Selecting the function

Press the FUNCTION button to select the desired function. The selected function indicator lights in red.

The function is automatically selected when CD play or tape playback is started, or when the BAND button has been pressed (except during recording or tape dubbing).

- When the function selection is changed, CD play or tape playback is automatically stopped.

Adjusting the volume

Turn the VOLUME control, or press the "+" or "-" VOLUME button on the remote control.

Adjusting the left/right speaker balance

Use the BALANCE control to adjust the left/right speaker balance.

Adjusting the sound quality

Turn the SPECTRUM CONTROL to LOW to increase the low frequencies. Turn the control to HIGH to increase the high frequencies.

To reduce the volume temporarily (muting)

Press the MUTE button on the remote control. "MUTE" blinks on the display.

To restore the previous volume setting, press the MUTE button again. "MUTE" disappears.

Bass expander system

Press the BASSXPANDER button to enhance the bass sound. "BASS" appears on the display.

- The initial setting of this function is ON.

Selecting the sound mode

Press the SOUND PRESET button to select the sound mode matching the music to be listened to.

POP: Pops, etc.

ROCK: Rock music, etc.

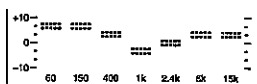

CLASSIC: Classical music, etc.

JAZZ: Jazz, etc.

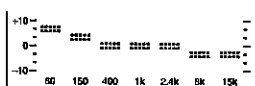
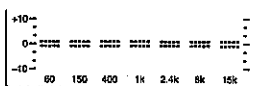

Selecting the DSP (Digital Signal Processor) surround mode

The DSP SURROUND button can be used to select the desired DSP surround mode according to your speaker placement and the type of music being played. Each time the button is pressed, the DSP surround and sound preset mode settings change in the following sequence:

LIVE: "Live" effect ("POP" is selected.)

STADIUM: "Stadium" effect ("ROCK" is selected.)

HALL: "Hall" effect ("CLASSIC" is selected.)

Normal ("POP" is selected.)

If you wish to use a different sound preset setting after selecting the DSP surround mode ("LIVE" DSP surround setting and "CLASSIC" sound preset setting, for example), press the SOUND PRESET button after selecting the desired DSP surround mode.

Spectrum analyzer

Indicates the input level and peak value of each sound range.

Demonstration mode

If the DISPLAY button is pressed, the display enters the demonstration mode. The following display modes will sequentially appear.

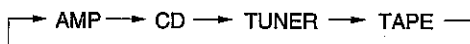

To cancel this mode, press the DISPLAY button again.

To turn the changer mechanism lights off

While pressing the MEMORY button, press the DISPLAY button.

- To turn the lights on, repeat step above.

WHAT TO DO IF ...

If the operation of the unit or display is not normal or when all the memory contents are to be cleared, disconnect the mains lead from the AC outlet, then press the RESET button (rear of the unit) for 30 seconds or more

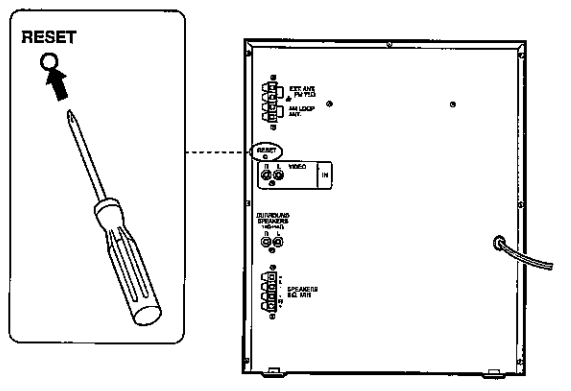

CD PLAY

Use compact discs bearing the symbol as shown below. In addition to conventional 12 cm CDs, this system can be used to play 8 cm CDs without an adapter.



Note:

- Do not touch the disc tray while it is moving.
- Never place anything except a compact disc on the disc tray. Foreign objects can damage the unit.
- Do not apply excessive force to the disc tray.
- Discs must be placed on the disc tray one at a time.

If discs are loaded, you can turn the unit on and begin play immediately by pressing the PLAY/PAUSE, DISC 1, DISC 2 or DISC 3 button.

1. Select "CD" function by pressing the FUNCTION button. "CD" appears on the display, then "CD" is replaced by "dISC". "1" disc number blinks.
2. Press one of the disc select buttons (DISC 1, DISC 2 or DISC 3), then press the OPEN/CLOSE button.
 - If the disc select button which "no disc" has been detected by the changer mechanism is pressed, that disc tray slides out automatically.
 The selected disc indicator blinks and the selected disc tray slides out. "OPEN" appears on the display.
3. Place the disc with the label facing up on the disc tray.

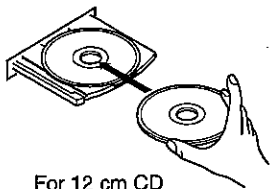

For 12 cm CD

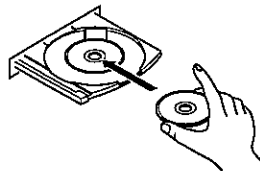

For 8 cm CD

4. Press the OPEN/CLOSE button again to close the disc tray.

Note:

To open or close the disc tray, be sure to use the OPEN/CLOSE button. If you push the disc tray by hand, only the tray slips in and the tray slide remains out.

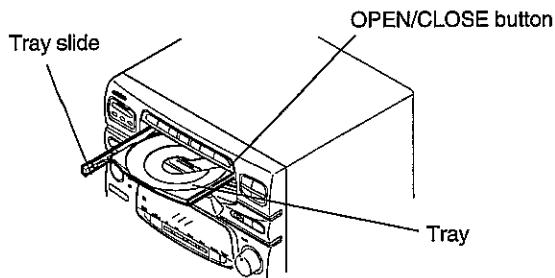

In this case, press the OPEN/CLOSE button. Do not touch the disc tray by hand.

5. Repeat steps 2 - 4 to load another disc.
6. Press one of the disc select buttons (DISC 1, DISC 2 or DISC 3).

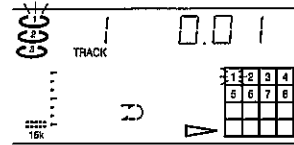

"▷" appears, and play starts from the first track of the selected disc.

The track number and elapsed play time for the current track are displayed.

Also, the whole track numbers (up to track 16) on the disc are displayed on the music calendar.

- When playing tracks numbered 17 or higher, no track number appears on the music calendar.
- If the desired disc number has been selected, the PLAY/PAUSE button can also be used to start play.

Note:

If the disc is loaded with the label facing downward, or if a badly scratched disc is loaded, "NO dISC" appears on the display.

If this occurs, load the disc correctly or replace the damage disc.

7. Press the STOP button to end disc play.
 - When the last track of the last disc has been played, the player stops automatically.
 - When the OPEN/CLOSE button is pressed during play, play will stop and the disc tray will slide out.

Ejecting or replacing discs

1. While in the CD play or stop mode, press one of the disc select buttons to be ejected, then press the OPEN/CLOSE button.
 - While the player is playing one disc, you can eject or replace another disc without stopping play.
2. Remove or replace the disc.
3. Press the OPEN/CLOSE button.

Notes on handling compact discs

- Do not expose the disc to direct sunlight, high humidity or high temperatures for extended periods of time.
- Discs should be returned to their cases after use.
- Do not apply paper or write anything on the disc surface.
- Handle the disc by its edge. Do not touch the playing surface (glossy side).
- Fingerprints and dust should be carefully wiped off the playing surface of the disc with a soft cloth. Wipe in a straight motion from the centre to the outside of the disc.
- Never use chemicals such as record cleaning sprays, antistatic sprays or fluids, benzene or thinner to clean compact discs.

To start play from the desired track

Using the remote control

1. Select the desired disc by pressing the DISC SELECT button, then press the ■ button on the CD controls.
2. Press two number buttons to select the desired track.

Using the main unit

1. Press the desired DISC button, then press the STOP button.
2. Select the desired track by using the SKIP/SEARCH buttons, then press the PLAY/PAUSE button.

Temporarily stopping play

Press the PLAY/PAUSE button. "▷" blinks on the display. To resume play, press the button again.

Skip play

To skip to track 6 while track 3 is playing, press the ►►/►► SKIP/SEARCH button repeatedly until "6" appears in TRACK on the display.

To skip back to track 3 while track 6 is playing, press the ◀◀/◀◀ SKIP/SEARCH button repeatedly until "3" appears.

- The number buttons on the remote control can also be used for skip play. To skip to track 6 while one track is playing, press 0, then 6.

Search (forward/reverse)

If the ►►/►► or ◀◀/◀◀ SKIP/SEARCH button is pressed during play, the player will search at high speed in the forward or reverse direction while the button is being pressed. When the button is released, normal play will continue.

Random play

Press the RANDOM button on the remote control to begin random play. The player will automatically select and play discs and tracks at random. "RANDOM" appears on the display.

- Random play will not function during programmed play.

Repeat play

Press the REPEAT button repeatedly to select the desired repeat mode in the following sequence. The selected repeat mode is shown on the display.

REPEAT ONE: Repeat one track.

REPEAT ALL: Repeat all tracks on the selected disc.

REPEAT CONT: Repeat all tracks on all discs.

Released: Normal play mode

Note:

During programmed play, only "REPEAT ONE" and "REPEAT ALL" can be selected.

Disc check

Press the DISC CHECK button to play the first 10 seconds of the first track of each disc. "▷" and "DISC CH" appear and the disc number blinks on the display.

- Press the STOP button to stop disc check.
- Disc check will not function during random play or programmed play.

PROGRAMMED PLAY

Up to 32 selections, from up to 3 discs, can be programmed for play in any order.

- To begin the programming procedure, select "CD" function first.
- The discs or tracks must be programmed in the stop mode.
- The same disc or track can be programmed more than once.

Follow the example below to programme tracks 6 and 2 on DISC 1 and all tracks on DISC 3. In this example, each disc has 9 tracks and DISC 3 is in playing position.

1. Press the MEMORY button.

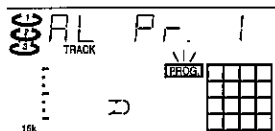

2. Select disc 1 by pressing the DISC 1 button.
 - The DISC SELECT button on the remote control can also be used.

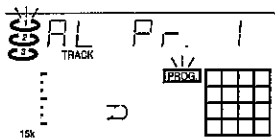

3. Select track 6 by pressing the ►►/►► SKIP/SEARCH button.
 - The number buttons on the remote control can also be used.

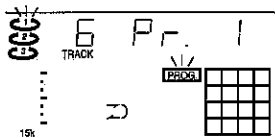

4. Press the MEMORY button.

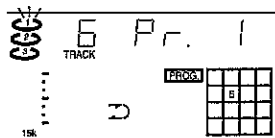

5. Select track 2 by pressing the ◀◀/◀◀ SKIP/SEARCH button.

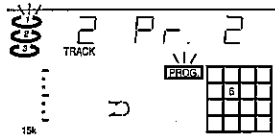

6. Press the MEMORY button.

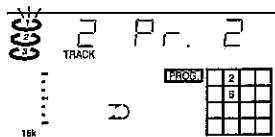

7. Select disc 3 by pressing the DISC 3 button.

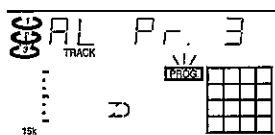

8. Press the MEMORY button.

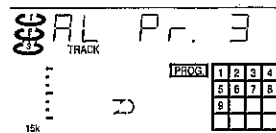

9. Press the PLAY/PAUSE button to start play.

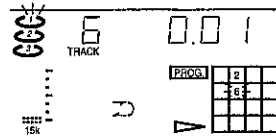

When all programmed selections have played, the player stops automatically. "0 0.00" appears on the display.

- The programme contents are retained in memory.

- Any attempt to programme more than 32 selections will result in "FULL" being displayed and discontinuation of the programming.
- If a non-existent disc or track number is programmed, that disc or track will be skipped during play.
- The programme is cleared when the STOP button is pressed in the stop mode.

Checking the programme

Each time the MEMORY button is pressed in the stop mode, the programmed details sequentially appear on the display.

Changing a programme

To add a new selection to a programme:

1. In the stop mode, press the MEMORY button repeatedly until " - - - - " is displayed.
2. Select a disc and track number as explained above.
3. Press the MEMORY button.

To change a selection:

1. In the stop mode, press the MEMORY button repeatedly until the selection to be replaced is displayed.
2. Select a disc and track number as explained above.
3. Press the MEMORY button.

Note:

Programmed details cannot be partially deleted or inserted.

WHAT TO DO IF ...

If "ME dISC" appears.

1. Press the POWER button to turn the power off.
2. Press the POWER button to turn the power on.

If the operation of the unit or display is not normal, even though the appropriate buttons have been pressed.

1. Disconnect the mains lead.
2. Press the RESET button (rear of the unit) for 30 seconds or more.
3. Connect the mains lead.
4. Press the POWER button to turn the power on.
5. Press the desired function button.

Note:

If the unit does not operate correctly, or "ME dISC" appears again, please contact your nearest SANYO Authorized Service Centre.

LISTENING TO TAPES

Deck A is for playback only; deck B is for both playback and recording.

If a cassette is loaded, you can turn the unit on and begin play immediately by pressing the ► or ◀ button.

1. Select "TAPE". "TAPE" appears on the display, then "TAPE" is replaced by the tape mode display.
2. Press the cassette holder (EJECT portion) to open it.
3. Load the cassette(s).

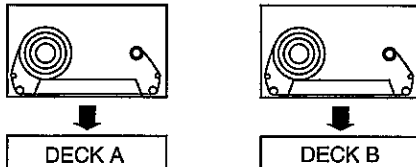

After loading the cassette(s), push the cassette holder (EJECT portion) back into position. The DECK A or DECK B indicator lights.

4. Set the DOLBY NR button according to whether the tape has been recorded with the Dolby NR system or not.
 - With Dolby NR "DD B NR" appears
 - Without Dolby NR "DD B NR" disappears
5. Select deck A or deck B by pressing the DECK button if required. (If only one cassette is loaded, deck A or deck B will be selected automatically.)
6. Select the reverse mode with the REVERSE MODE button as desired.
7. Press the ► or ◀ button to begin playback. "►" or "◀" appears on the display.
 - : For forward play
 - ◀ : For reverse play

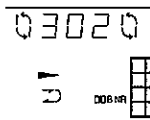

8. Press the ■ button to stop playback at any time. When the end of the tape has been reached, automatic stop or reverse will be activated.

Types of usable tapes

The type of tape used is automatically identified by the system since decks A and B both employ an auto tape selection system. The following types of tape can be used with this system.

- Normal
- CrO2
- Metal (Playback only)

Note:

- CrO2/Metal tapes without sensing holes cannot be used since they cannot be identified by the auto tape selector.
- Endless tapes cannot be used.
- Do not use C-120 tapes. They may jam in the mechanism.

Auto reverse

Press the REVERSE MODE button to select the reverse mode as desired.

⌂ :

For listening to one side of the tape only.

⤵ :

For listening to both sides of the tape in succession.

- If playback has been started from the reverse side, only the reverse side will be played back.

↻ :

For listening repeatedly to both sides of the tape.

Fast forward and rewind

Press the ►► or ◀◀ button. "►" or "◀" blinks.

When the tape has been wound to the end, the deck stops automatically.

Tape counter

Each deck has a counter. The counter of the selected deck appears on the display and helps you to quickly locate the recorded selection for playback.

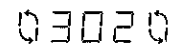

Both sides of the counter indicate tape movement with rotating graphic displays.

To reset the tape counter to "000"

In the stop mode, press the DECK button to select the counter to be reset, then press the ■ button.

- When the tape is automatically rewound during CD computer recording or tape high-speed dubbing, the counter automatically resets to "000".

Relay playback (continuous playback)

1. Load the cassettes into both decks.
2. Set the REVERSE MODE button to ⤵.
3. Select deck A or deck B by pressing the DECK button if required.
4. Press the ► or ◀ button.
 - Relay playback will continue from deck A (or B) to deck B (or A) until the ■ button is pressed.

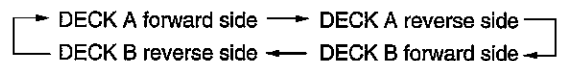

Dolby NR system

Dolby Noise Reduction circuitry provides superior recording and playback results by suppressing tape hiss by up to 10 dB.

Dolby noise reduction manufactured under license from Dolby Laboratories Licensing Corporation.

"DOLBY" and the double-D symbol DD are trademarks of Dolby Laboratories Licensing Corporation.

LISTENING TO THE RADIO

To turn the unit on and listen to the last received station, press the BAND button.

Manual tuning

1. Press the BAND button to select FM or AM.
 - "TUNER" is selected automatically. "TUNE" appears on the display, then "TUNE" is replaced by the tuner mode display.
2. Press the "+" or "-" TUNING button continuously until you are close to the desired frequency, then press it briefly until the desired frequency is displayed. Each time the button is pressed, the frequency changes in 0.05 MHz steps for FM and 9 kHz steps for AM.

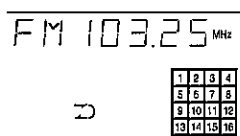

To preset stations

Up to 16 stations in each band (FM and AM) can be preset.

1. Tune in the station to be preset as described in "Manual tuning".
2. Press the MEMORY button.

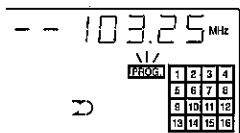

3. Press the "+" or "-" PRESET button to select the channel number to be preset.

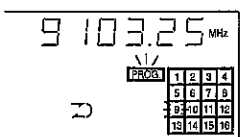

4. Press the MEMORY button.
 - In this example, "103.25 MHz" FM station is preset on FM channel number 9.
 - The number buttons on the remote control can be used for preset the station. In this example, press 0, then 9 after the step 2 above.

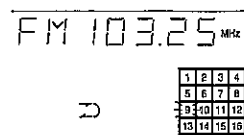

Note:

If the next step is not taken within 10 seconds while performing steps 2 - 4, "PROG." disappears and the preset operation is cancelled. Press the MEMORY button to continue.

5. Repeat the steps above to add more preset stations.
 - When presetting a new station, the previously preset station on the same channel number of the same band is cleared.
 - The preset stations will be retained in the memory even if the unit is turned off. If the memory contents are lost due to a power failure or other condition, preset the stations again.

Listening to preset stations

1. Press the BAND button to select FM or AM.
2. Press the "+" or "-" PRESET button to select the desired channel number. The selected channel number blinks on the display.
 - The number buttons on the remote control can also be used. Press two number buttons within 4 seconds.
- To receive an FM stereo broadcast, make sure that "MONO" is not displayed. If "MONO" appears, press the FM MODE button to turn the "MONO" indication off. "ST" appears when an FM stereo broadcast is received.
- If the signal from an FM stereo station is weak and reception is poor, press the FM MODE button to change to monaural reception. ("ST" is replaced by "MONO" in the display.)

Changing the AM reception frequencies

It is not necessary to perform this procedure in the Australia and New Zealand.

1. Press the BAND button to select "AM".
2. While pressing the MEMORY button on the front panel, press the ■ button (Deck section) on the front panel.

522 - 1710 kHz (9 kHz steps) ← → 520 - 1710 kHz (10 kHz steps)

LISTENING TO VIDEO SOURCES

1. Select "VIDEO". "VIDEO" appears on the display.
2. Follow the instructions supplied with the video equipment.

BEFORE RECORDING AND DUBBING

Recording copyright material without permission of the copyright owners is usually an infringement. If you wish to re-record copyright material, permission from the copyright owner is necessary. SANYO does not approve of, and cannot be held responsible for, any unlawful use of this machine.

Use deck B for recording.

1. Press the cassette holder (EJECT portion) to open it and load the cassette for recording.
2. Set the DOLBY NR button to ON or OFF as desired.
Dolby NR ON "□□ B NR" appears
Dolby NR OFF "□□ B NR" disappears
3. Set the reverse mode with the REVERSE MODE button.
⏮ :
For recording one side only.
⏪ :
For recording both sides in succession.
 - If recording has been started from the reverse side, only the reverse side will be recorded.
 - If a tape with one of its tabs already broken out is used for recording, the tape will not be reversed automatically, and it will stop.
 - If the REC PAUSE, COMPUTER REC or DUBBING HIGH button is pressed while the ⏪ mode is selected, the ⏪ is selected automatically.

Recording will start in the forward direction under the following conditions:

- When CD computer recording is used
- When tape high-speed dubbing is used
- When using the timer for unattended recording

Automatic record muting

Undesirable parts of a programme can be omitted while recording.

Press the REC MUTE button on the remote control once while recording. The REC PAUSE indicator blinks and a 5-second unrecorded blank space is created, then the cassette deck enters the record pause mode. The REC PAUSE indicator lights and "▶" or "◀" blinks on the display.

- To add another 5-second blank space, press the REC MUTE button again.
- To resume recording, press the ▶ or ◀ button whose "▶" or "◀" is blinking.

Note:

The record muting function does not operate during CD computer recording or tape high-speed dubbing.

Accidental erasure prevention tabs (for protecting valuable recordings)

Accidental erasure can be prevented by breaking out the tabs on the end of the cassette tape (where the tape is not exposed) using a screwdriver or similar implement.

If a tab is broken out in error and you wish to re-record the tape, simply block the tab hole using adhesive tape and the tape can be used for recording again.

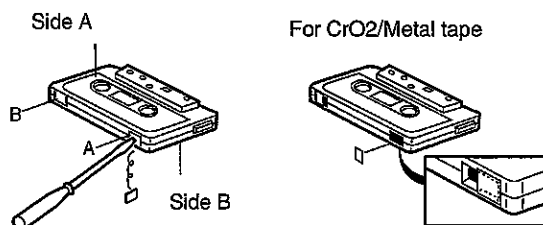

Break out tab A for side A.
Break out tab B for side B.

RECORDING

RECORDING COMPACT DISCS

Computer recording

With computer recording, you can record a CD onto a cassette by pressing just one button.

1. Load the disc(s) to be recorded.
2. Load a blank cassette into deck B.
3. Select "CD".
 - For programmed recording from up to 3 discs, programme the material in advance (as described under "PROGRAMMED PLAY").
4. Press the disc select button (DISC 1, DISC 2 or DISC 3) to select the disc to be recorded, then press the STOP button.
 - For programmed recording, this step is unnecessary.
5. Select "⏮" mode.
6. Press the COMPUTER REC button.

The system automatically performs the following functions:

Deck B:

- The tape rewinds to the beginning.
- Recording starts.

CD player:

- The player searches for the first track to be recorded, then enters the pause mode.
- CD play starts.

Manual edit recording

Recording starts without rewinding the tape initially. Press the EDIT button to turn the "MANUAL" indication on before proceed step 6.

- To cancel this mode, press the button again. "MANUAL" disappears.
- After loading the cassette, the tape must be wound to the point where you would like to start recording.

The DECK B and REC PAUSE indicators light, "COMPU. REC" and "A" appear on the display as recording begins.

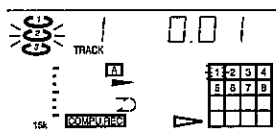

If the tape reverses from side A to B while a track is still playing, the CD player enters the pause mode at the beginning of the track that was playing. This track will be recorded at the beginning of side B.

When the end of the tape (side B) is reached, the CD player and deck B stop automatically.

- If the last track on the CD plays completely before the end of the tape, disc play stops automatically. Deck B also stops.

Note:

- Recording starts automatically after 8 seconds, so the recording will not be interrupted by the leader tape at the beginning of sides A and B.
- A 5-second blank space is automatically recorded at the end of each track.
- To stop computer recording at any time, press the STOP button on the CD player or the ■ button on the deck. The CD player and deck B will stop.
- When CD computer recording is used, repeat play mode is canceled automatically.

Manual recording

1. Follow the steps 1 - 3 under "Computer recording" above.
 - If required, press the disc select button (DISC 1, DISC 2 or DISC 3) to select the disc, then press the STOP button. Select the track number to be recorded.
2. Press the REC PAUSE button. Deck B enters the record pause mode. The REC PAUSE and DECK B indicators light. Both "▶" and "◀" blink on the display.
3. Press the ▶ or ◀ button. "▶" or "◀" lights and recording starts.
4. To stop recording, press the ■ or STOP button.

When the end of the tape (side B) is reached, the CD player and deck B stop automatically.

- If the last track on the CD plays completely before the end of the tape, disc play stops automatically. Deck B also stops.

RECORDING FROM THE TUNER OR VIDEO INPUT

1. Load a blank cassette into deck B.
2. Tune in the radio station to be recorded, or play video cassette or video disc.
3. Press the REC PAUSE button. Deck B enters the record pause mode.
4. Press the ▶ or ◀ button. Recording starts.
5. Press the REC PAUSE button to temporarily stop recording. Press again the ▶ or ◀ button whose "▶" or "◀" is blinking to continue.
6. Press the ■ button to stop recording.

When beat interference is heard

A high-pitched noise called "beat" is sometimes heard during the recording of radio broadcasts.

If this occurs,

1. Press the MEMORY button.
2. While "PROG." is blinking, press the ►►/►►| SKIP/SEARCH button to select "bc-1" or "bc-2". Select the setting that gives the best results.

TAPE DUBBING (DECK A TO DECK B)

Load the cassette to be played back into deck A and a blank cassette into deck B.

High-speed dubbing

For simple, automatic dubbing in one-half the time, compared to normal-speed dubbing.

- Use the same length cassettes in both decks for the high-speed dubbing operation.

Press the DUBBING HIGH button. "TAPE" is selected automatically and "dub" appears on the display.

The system performs the steps below and automatically starts deck A playback and deck B recording.

- 1) Deck A: Tape rewinds.
- 2) Deck B: Tape rewinds.
- 3) Deck B: Erases the first few seconds of the tape.

The REC PAUSE, DECK B and DECK A indicators light, "dub" and "▶" appear on the display as dubbing begins.



- Before pressing the DUBBING HIGH button, check that both decks are in the stop mode.
- Press the ■ button to stop dubbing at any time. The tape will not stop during high-speed dubbing if the REC PAUSE button is pressed.
- During high-speed dubbing, normal monitoring is not possible.
- High-speed dubbing must start from the beginning of the tape. To start dubbing from a position in the middle of the tape, use manual dubbing.

Manual (normal-speed) dubbing

For dubbing while listening to the playback from deck A.

1. Select "TAPE".
2. Select "Σ" mode.
3. Deck B: Locate the tape position where recording will begin.
4. Deck A: In the same direction of deck B, locate the selection of the tape to be dubbed.
5. Press the REC PAUSE button. The REC PAUSE and DECK B indicators light. Both "▶" and "◀" blink on the display.
6. Press the ▶ or ◀ button (to match the same direction in the steps 3 and 4 above). The DECK A indicator and "▶" or "◀" light. Manual dubbing starts.
 - Both decks run in the same direction.
7. Press the ■ button to stop dubbing.

Automatic stop during tape dubbing

If deck A or deck B stops automatically, the other deck will also stop.

- During tape dubbing, the DOLBY NR button has no effect on the copied tape. If the tape to be copied is encoded with Dolby NR, the copy will be Dolby NR encoded automatically.

TIMER OPERATION (Using the remote control)

Using the on/off timer

Set the on and off times, function to be used and volume level. Operation will start with the selected function at the on time and the power will be switched off at the off time.

The on/off timer will function every day unless it is released.

Preparation

Note:

Make absolutely sure that the clock is set to the correct time before setting the timer.

- Select the function for timer operation and prepare the sources to be used.
- If the function selected is tuner, tune in to the desired band and station.
- For tape playback: If cassettes have been loaded into both decks, deck A takes precedence. Tape playback and recording will start only from the forward side.
- Adjust the volume level as desired.

Operation

1. Press the TIMER button.

AM 12:00



The previous timer on time setting appears.

2. Press the ADJUST button within 10 seconds.

AM 12:00



3. Set the timer on time by pressing the + or - TUNING/TIME SET button, then press the ADJUST button (as described under "ADJUSTING THE CLOCK").

AM 7:00 → AM 7:00



The timer off time setting appears.

4. Set the timer off time as described in step 3.

AM 8:30 → PLAY



The previous timer mode setting (play or recording) appears.

5. Select the timer mode by pressing the + or - TUNING/TIME SET button.

- Each time the button is pressed, "REC" and "PLAY" blinks alternately. Select the "REC" for unattended recording.
- If you wish to change the function, press the FUNCTION button on the front panel to select the desired function.

6. Press the ADJUST button.

The original display returns, then the timer operation standby mode is activated. "o" (or "o REC") remains lit.

7. Press the POWER button to switch off the power.

- "o" (or "o REC") blinks during a timer controlled operation.
- To switch off the power during a timer controlled operation, press the POWER button. The timer will be set in the standby mode.

To check the timer settings

Press the TIMER button repeatedly. The timer settings are displayed in the following order:

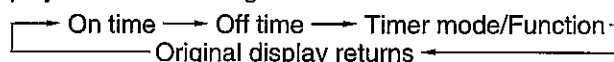

To change the settings, press the TIMER button to select the setting to be changed, then press the ADJUST button so that the display blinks. Change the setting as explained above.

To release the timer

After turning the power on, press the TIMER button, then press the SET/CLEAR.

To set the timer again with the same settings

1. Press the TIMER button, then press the SET/CLEAR.
2. Press the POWER button to switch off the power.

Note:

- If the SET/CLEAR button is pressed while the timer is being set, the original display returns.
- The timer mode is released if a power failure occurs during timer controlled operation.
- The timer may not operate if a power failure occurs during timer operation standby mode.

Using the sleep timer

The sleep timer automatically switches off the power after a preset time has elapsed. There are 12 time periods available: 10, 20, 30, 40, 50, 60, 70, 80, 90, 100, 110, and 120 minutes.

1. Press the SLEEP button. The previous sleep time setting appears.
2. Press the ADJUST button within 10 seconds.
3. Select the sleep time by pressing the + or - TUNING/TIME SET button.

→ 60 → 70 → ... → 110 → 120 → 10 → ... 50
(or in the reverse sequence)

30



4. Press the ADJUST button. The original display returns and "SLEEP" blinks.

To check the remaining sleep time

Press the SLEEP button once. The remaining time is displayed. Press the SLEEP button again or allow 10 seconds to elapse, the original display returns.

To release the sleep timer while in operation

Press the SLEEP button, then press the SET/CLEAR. The timer is also released if the power is switched off.

MAINTENANCE

Cleaning the decks A and B heads

To ensure playback and recording with good-quality sound, use cotton swab to clean the heads, pinch rollers and capstans of the decks after about every 10 hours of use. If the dirt persists, soak the swab in a little methylated spirit or head cleaning fluid and then clean.

Main unit

Use a soft cloth to remove dirt on the main unit. If the dirt persists, dip a soft cloth into a diluted solution of neutral detergent, wring it out, wipe away the dirt, and then take up any moisture with a dry cloth. Do not use benzene, thinners or alcohol since they will mar the finish of the surfaces.

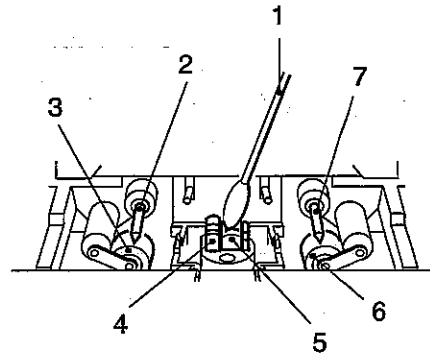

- 1. Cotton swab
- 2, 7. Capstan
- 3, 6. Pinch roller
- 4, 5. Head

REMOTE CONTROL

Note:
The buttons on the remote control perform similar functions to similarly marked buttons on the front panel.

Common section

- | | |
|----------------------------|---------------|
| Power on/off | POWER |
| Adjust volume | + or - VOLUME |
| Select sound preset | SOUND |
| Temporarily mute the sound | MUTE |
| Bass expander on/off | BASS |
| Select DSP surround | DSP |
| Select "VIDEO" function | VIDEO |
- "CD" is automatically selected when the ►/|| or DISC SELECT button is pressed.
 - "TUNER" is automatically selected when the TUNER/BAND button is pressed.
 - "TAPE" is automatically selected when the ► or ◀ button is pressed.

Clock/Timer section

- | | |
|----------------------|--|
| Display clock | CLOCK |
| Adjust clock | (CLOCK) → ADJUST → + or - TUNING/TIME SET → ADJUST |
| Set on/off timer | TIMER → ADJUST → + or - TUNING/TIME SET → ADJUST → POWER |
| Release on/off timer | TIMER → SET/CLEAR |
| Set sleep timer | SLEEP → ADJUST → + or - TUNING/TIME SET → ADJUST |
| Release sleep timer | SLEEP → SET/CLEAR |

Tuner section

- | | |
|-----------------------------------|---------------------------------------|
| Select "TUNER" and/or Select band | TUNER/BAND |
| Station tuning | (TUNER/BAND) → + or - TUNING/TIME SET |
| Select preset station | (TUNER/BAND) → 1 - 9, 0 |

CD player section

- | | |
|-----------------------------------|--|
| Select "CD" and/or Start play | ►/ |
| Select the desired disc and track | DISC SELECT → 1 - 9, 0, ◀◀ or ▶▶ |
| Programmed play | In CD mode MEMORY → DISC SELECT → 1 - 9, 0, ◀◀ or ▶▶ → MEMORY → ►/ |
| Temporarily stop play | During play ►/ |
| Skip play | During play ◀◀ or ▶▶ (press once) |
| Search | During play ◀◀ or ▶▶ (press continuously) |
| Repeat play | REPEAT |
| Random play | RANDOM |
| Stop | ■ |

Cassette deck section

- | | |
|-------------------------------------|---------------------------|
| Select "TAPE" and/or Start playback | ► or ◀ |
| Select deck | DECK A/B |
| Fast wind | ▶▶ or ◀◀ |
| Start recording | ●/ → ► or ◀ |
| Temporarily stop recording | During recording ●/ |
| Record mute | During recording REC MUTE |
| Stop | ■ |

SPECIFICATIONS

Tuner section

Reception frequency:
FM: 87.5 - 108 MHz
AM: 522 - 1710 kHz

CD player section

Type: Changer, 3-disc
Channels: 2-channel stereo
Sampling frequency: 44.1 kHz
Pick-up: Optical 3-beam semiconductor laser
Laser output: 0.6 mW (Continuous wave max.)
Wave length: 790 nm
Frequency response: 20 Hz to 20 kHz
Wow/flutter: Below measurable limits

Cassette deck section

Track system: 4-track, 2-channel stereo
Frequency response: 50 Hz to 15 kHz (CrO2 tape)
50 Hz to 14 kHz (Normal tape)
Signal-to-noise ratio: 60 dB (Dolby NR ON)
Wow/flutter: 0.12% (WRMS)
Fast forward/rewind time: Approx. 120 sec. (C-60)

Amplifier section

Output power: 80 W x 2 (at 6 ohms, 10% distortion)
Sound preset: Four electronic presets
Inputs: VIDEO IN: 400 mV/50k ohms
Outputs: SPEAKERS: 6 ohms
SURROUND SPEAKERS: 16 ohms
PHONES: 8 - 32 ohms

Power requirements: AC 230 ~ 240 V, 50 Hz
Power consumption: 155 W
Dimensions: 270(W) x 333(H) x 302(D) mm
Weight: 10.4 kg

Speaker systems

Type: 3 way bass reflex
Unit used: Woofer: 16 cm cone type
Mid range: 5 cm cone type
Tweeter: piezoelectric
Maximum power-handling capacity: 160 W (peak)
Nominal impedance: 6 ohms
Dimensions: 200(W) x 330(H) x 250(D) mm
Weight: 3.8 kg (per speaker)

Specifications subject to change without notice.

