



# SANYO

---

**INSTRUCTION MANUAL**

**DMP-M400SD**

**Digital Music Player**

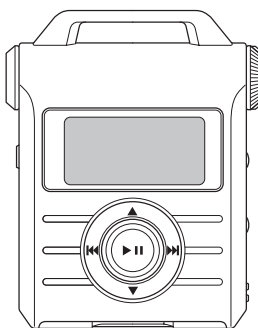

<b>GB</b>	English
<b>E</b>	Español





## [ENGLISH]

### Contents

Precautions .....	1	Disconnecting the unit from your PC .	12
Safety Precautions .....	2	Before Using .....	13
Features .....	5	Music Mode .....	17
Controls .....	6	FM Mode .....	21
Description on LCD .....	7	Setup Mode .....	24
Operating Environment .....	8	Troubleshooting guide .....	28
USB Driver Program .....	9	Cleaning the cabinet .....	30
Connect the unit to your PC .....	11		

### Precautions

- IBM and PC/AT are registered trademarks of International Business Machines Corporation.
- Microsoft, Windows Media™, and the Windows® Logo are trademarks or registered trademarks of Microsoft Corporation in the United States and/or other countries.
- Windows Media™ Player is trademark or registered trademark of Microsoft Corporation.
- SD™ is registered trademark of SD Association.
- Other system and product names generally are the registered trademarks or trademarks of the respective development manufacturers. The symbols ™ and ® are not shown in this manual.
- SANYO takes no responsibility for recording failure due to power cuts or damage to the unit.
- To avoid potential risk of data loss caused by accidental operation or malfunction of the unit, we recommend that you save a backup copy of your recorded messages on a PC, etc..
- Recording copyright material without permission of the copyright owners is usually an infringement. If you wish to re-record copyright material, permission from the copyright owner is necessary. SANYO does not approve of, and cannot be held responsible for, any unlawful use of this machine.





## Safety Precautions

- This manual contains important information on safety precautions and product handling to prevent an accident. Make sure to read this manual carefully before using this product.
- Keep this manual in a safe place where you can find easily after reading this manual.
- SANYO will bear no responsibility over the loss caused by memory erasure due to product breakdown, repair or other reasons.

### Warning and Caution symbols



#### Warning

If mishandled, the user might get injured or product malfunction may occur.



#### Caution

If mistreated, the user may get harmful effect, or there may be errors in the system.



## Safety Precautions

### Storage precautions

- Do not use or store where there are extremes of temperature. (below 5°C or exceeding 35°C)
- Keep out of the children's reach.
- Do not store the product at high humidity, wet or dusty area.

### Usage precautions

- Do not drop the product or apply strong shock.
- Do not apply strong shock to the LCD.
- Remove battery immediately if the product gives off smoke or deformed due to heat.
- Do not use the product in the prohibited area where the electronic device usage is forbidden such as the aircraft.
- If you set the volume too high, your hearing ability may be impaired.  
Set the proper volume.  
If you experience a ringing in your ears, reduce the volume or discontinue use.
- There is a risk of the car accident if you use this product while you're driving or walking on the street.
- Do not disassemble the product.



Your SANYO product is designed and manufactured with high quality materials and components which can be recycled and reused.

This symbol means that electrical and electronic equipment, at their end-of-life, should be disposed of separately from your household waste.

 Please dispose of this equipment at your local community waste collection/recycling centre.

In the European Union there are separate collection system for used electrical and electronic products.

Please help us to conserve the environment we live in!



## Safety Precautions

### Battery Usage Precautions

- Make sure to use the battery specified in this manual. (AAA alkaline battery)
- Frictional heat can set the fire. Keep away from the metallic objects such as battery, coin or key.
- Remove the battery from the product if you do not use the product for a long time.
- Check the proper polarities (+/-).

### Note

Dispose of all used battery safely in accordance with all applicable laws.



### Warning

- If your cloth or skin is stained with an electrolyte, clean with water immediately and consult your doctor.
- If your eyes are stained with an electrolyte, do not rub it and wash it with clean water immediately and consult your doctor.



## Features

- **SD Card Slot**
- **MP3, WMA**
- **Portable USB Mass Storage Device**
- **Music Mode - Normal, Pop, Rock, Classic, Jazz**
- **Easy to USB Navigation Function**
- **FM Stereo**

### Note:

- This handling description is printed prior to product development.  
When a part of the product specification must be changed to improve operability or other functions, priority is given to the product specification itself. In such instances, the instruction manual may not entirely match all the functions of the actual product.  
Therefore, the actual product and packaging, as well as the name and illustration, may differ from the manual.
- The screen/LCD display shown as an example in this manual may be different from the actual screen/LCD display.
- DRM9 (Digital Rights Management 9) is supported.  
DRM10 is not supported.

## Accessories

USB Cable x 1  
CD-ROM x 1  
Headphones x 1  
AAA/LR03/HP16 Alkaline battery x 1



## Controls

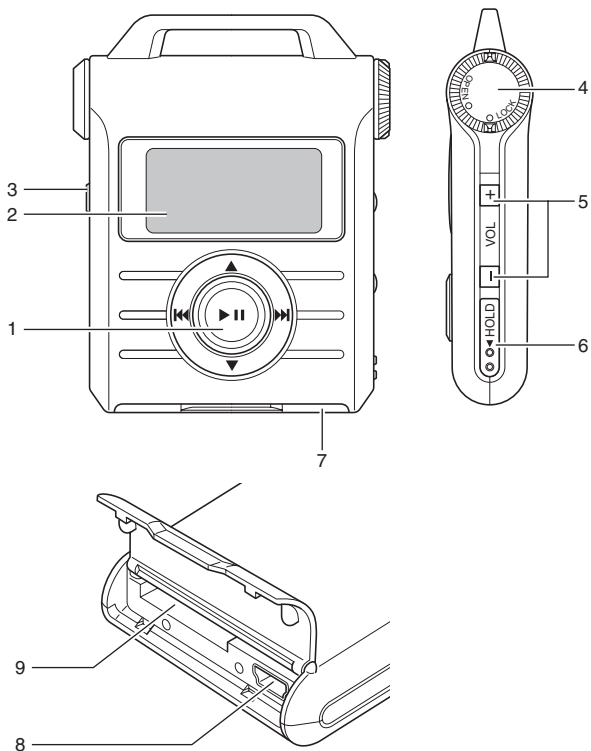

1. ►|| (Power/Operation) button
2. LCD Display
3. Stereo Headphone Terminal
4. Battery Compartment Lid
5. Volume +, - buttons
6. HOLD Switch
7. SD Card Slot Lid
8. USB Terminal
9. SD Card Slot

[ENGLISH]

**GB-6**



# Description on LCD

## Music (WMA/MP3)

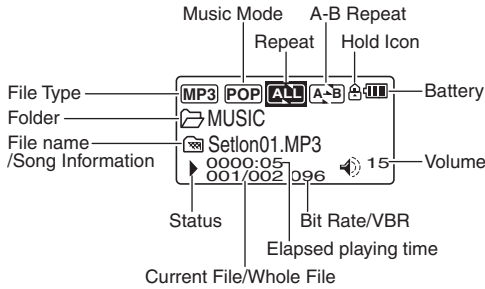

## FM

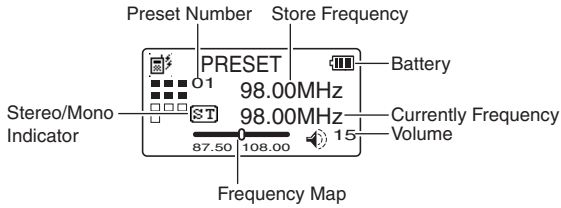

## GB-7

[ENGLISH]







## Operating Environment

Supported PCs	IBM PC/AT compatible
Supported OS	Windows XP Professional Windows XP Home Edition Windows Millennium Edition(Me) Windows 2000 Professional Windows 98 Second Edition
USB port	One required for connection
Sound board	16-bit Windows-compatible sound board supported
Other	Speakers or headphones required

### Note:

- Operation is not guaranteed for Macintosh PCs.
- Operation is not guaranteed for the following environments.
  - Upgraded Windows environments  
Windows 95, Windows 98, Windows NT
  - Dual-boot Windows environments
- Operation is not guaranteed for all PCs, even if they comply with the recommended environment.
- Standby, suspend, and other modes may not work properly with your particular environment. If this is the case, do not use those modes.

- A USB driver is required for Windows 98SE.  
The USB driver must be installed from the CD-ROM (Supplied) before connecting the unit to your PC.



## USB Driver Program

### Installing the USB driver for Windows 98SE

If you are using Windows 98SE, you need to install the USB driver.

- There is no need to install the USB driver, if you are using Windows XP/2000/ME.
  - Reproduction of this driver is forbidden.
  - This driver shall not be copied and reprinted.
  - SANYO shall not be liable for any damages arising out of the use of this driver.
1. Turn on your PC and Windows is started. Do not connect the unit to the PC yet.
  2. Load the USB driver CD-ROM (supplied) in the CD-ROM drive of the PC. [USB Mass Storage Driver Setup] screen appears automatically.

Note:

- If the screen is not displayed, right-click [Start], select [Explore].  
Double click "Setupapp.exe" file in the CD-ROM. [USB Mass Storage Driver Setup] screen appears.
- Click [Uninstall] to remove the USB driver program from your PC.

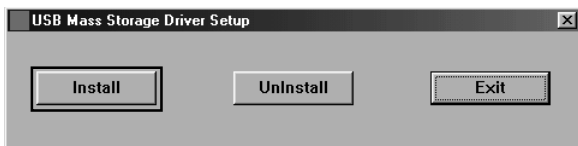



3. Click [Install]. [Install] screen appears.

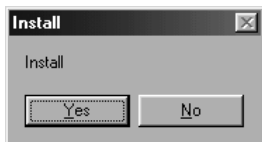

4. Click [Yes].



5. Click [OK]. The PC will restart.





## Connect the unit to your PC

Insert SD Card into SD Card slot before connecting to a PC.

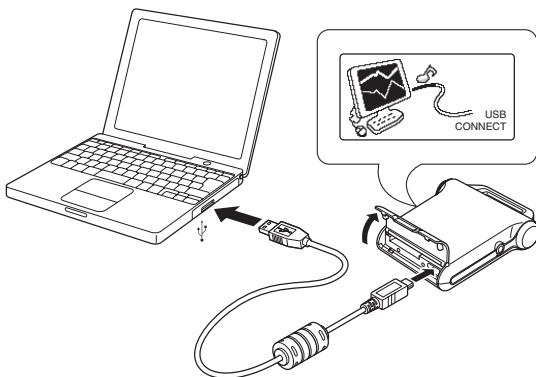

Note:

- Do not use an USB hub or USB extension cable (Operation is not guaranteed). Use only the supplied USB connection cable for connection.
  - When you connect the unit to the PC for the first time, it sometimes may not be recognized as a Removable Disk. In this case, disconnect the unit and reconnect it again.
  - The unit will operate without battery while the unit is connected to the PC.
- A USB driver is required for Windows 98SE.  
The USB driver must be installed from the CD-ROM (Supplied) before connecting the unit to your PC.





## Disconnecting the unit from your PC

Before disconnecting, make sure no data is being transferred.

For Windows 98SE

Disconnect the unit from your PC.

For Windows XP/2000/ME

Follow the steps below to disconnect. (The screen shots are of Windows XP.)

- The screen might be different for a different OS.

1. Right-click the Task tray icon at the bottom right of the Windows screen.



If the icon is not displayed, refer to the Windows help.

2. Click [Safely Remove Hardware] displayed.





## Before Using

### 1) Battery

#### Installing Battery

One AAA/LR03/HP16 Alkaline battery

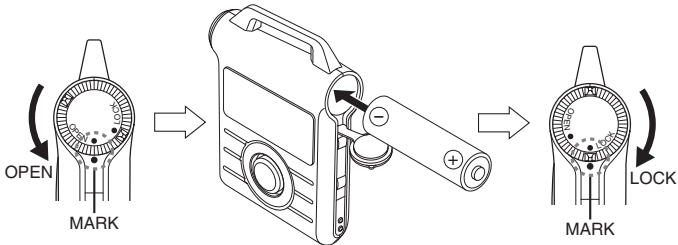

Adjust the “●” marks when opening or closing.

#### Battery indicator



Full



Level 2



Level 1



Exhausted  
(Time to replace)

#### Battery Lifetime

Battery	WMA/MP3 Playback	FM Listening
AAA Alkaline	Approx, 12Hours	Approx, 9Hours

#### Note

- Battery lifetime might be different depending on the kind of battery, volume, etc.
- It is optional to set to power off automatically.



## 2) Headphones (supplied)

Connect the headphones to the  terminal.

### Note

Be sure to reduce the volume before connecting or disconnecting the headphones.

## 3) SD Card

### Inserting the SD Card

1. Open the SD Card compartment lid.
2. Check the edge of the card and insert the card as shown.
3. Close the lid.

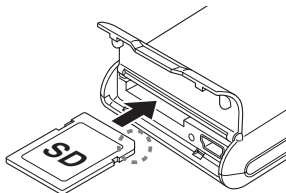

### Removing the SD Card

1. Press and hold  button to turn the power off.
2. Open the SD card compartment lid.
3. Push the card slightly into the slot to release.
4. Pull it out.

### Note

- Never remove the card while operating the unit.
- Do not place the card where it is exposed to static electricity or electric noise.
- 128MB/256MB/512MB/1GB/2GB SD card can be used. Some SD card may not be able to use with this unit.
- Switch the write-protect switch to "Lock" to protect your data.
- Do not touch the metal terminals of the card with your hands or metal objects.

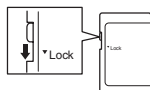



#### 4) Power On/Off

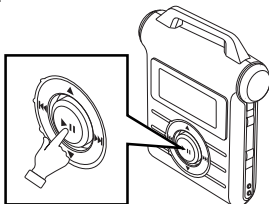

##### Power On

Press and hold ►|| button for at least 2 seconds, "HELLO!" appears briefly on the display and the power turns on.

##### Power Off

Press and hold ►|| button for at least 2 seconds, "SEE YOU!" appears and power turns off.

#### 5) Hold On/Off

Hold On = Slide HOLD switch to the left.

Hold Off = Slide HOLD switch to the right.

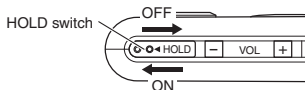

#### 6) Volume Control

Press +/- button shortly to control the sound volume.

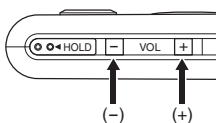





## 7) Switching Mode

Slide and hold ►|| button to ▲ for at least 2 seconds to enter Switching Mode.



Slide and hold to ▲ for at least 2 seconds



<MUSIC>



<FM>



<SETUP>

- 1) **MUSIC** : Music Files Playback such as MP3, WMA
- 2) **FM** : FM radio
- 3) **SETUP** : Function adjustment

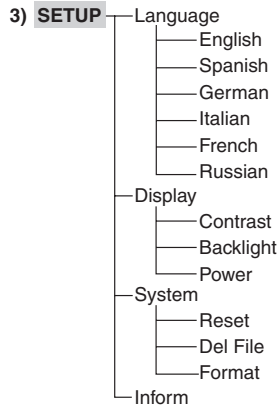
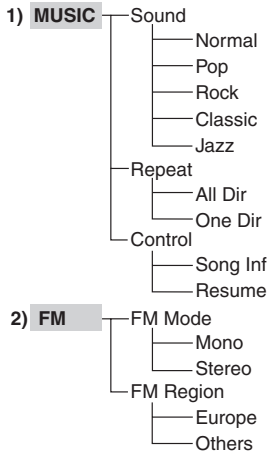



## Music Mode

### 1) Playback/Stop (Pause)



Press ►|| button shortly

**Playback :** Press ►|| button shortly once.

**Stop (Pause) :** Press ►|| button shortly once in the playback mode.

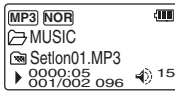

<Playback>

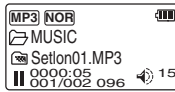

<Stop (Pause)>

### 2) File Search/Navigation/Selection



**File Search :** Slide ►|| button to ◀◀◀/▶▶▶ shortly/longer once.

**Navigation :** Slide ►|| button to ▲ shortly.

**Search :** In the playback mode, slide and hold ►|| button to ◀◀◀/▶▶▶ for at least 2 seconds.

As long as you press the button, you can move to the next files.

**Moving to the previous/next file :** Slide ►|| button to ◀◀◀/▶▶▶ shortly once in the playback mode.

**To skip the previous/next file :** In the playback, or stop(pause) mode, slide ►|| button to ◀◀◀/▶▶▶ shortly once. Select the file.

**Navigation mode :** In the playback or stop(pause) mode, slide ►|| button to ▲ shortly once.

You can select the file sliding ►|| button to ▲, ▼, ◀◀◀ or ▶▶▶.



#### Note

In the playback mode, when the play time is less than 5 seconds, then skipping to the previous file sliding ►|| button to ◀◀◀ shortly once.





### 3) Section Repetition (A-B)



Slide ►|| button to ▼ shortly.

- On :** Slide ►|| button to ▼ shortly once to select the point A during playback.  
Slide ►|| button to ▼ shortly once again to select the point B.  
Then the section from A to B is played repeatedly.
- Off :** Slide ►|| button to ▼ shortly once.

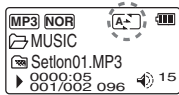

<Setting A Point>

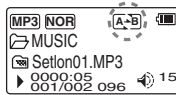

<Setting B Point>

### 4) Entering MENU mode

In MUSIC mode, slide and hold ►|| button to ▲ for at least 2 seconds, then select "MUSIC" and press ►|| button shortly to enter.



Slide and hold to ▲ for at least 2 seconds



Slide ►|| button to ◀◀ shortly to return to higher menu.

#### ● Sound



#### Sound

Slide ►|| button to ▲ / ▼ and Slide ►|| button to ►► shortly once.

Select desirable Sound type sliding and holding ►|| button to ▲ / ▼ and slide ►|| button to ►► shortly once.

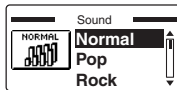

<Normal>

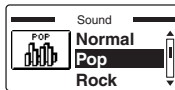

<Pop>

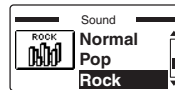

<Rock>



<Classic>

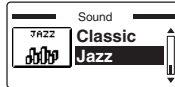

<Jazz>

[ENGLISH]

GB-18



## ● Repeat



### Repeat

Slide ►|| button to ▲ / ▼ and slide ►|| button to ►► shortly once.

Select desirable Repeat mode sliding ►|| button to ▲ / ▼ and slide ►|| button to ►►| shortly once.



### All Dir

Play all files in all folders in the SD card.



### One Dir

Play files in the selected folder.

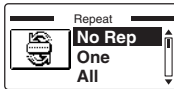

### No Rep

Play all files once in an order.



### No Rep

Play all files in the selected folder once in an order.

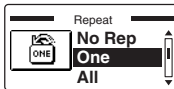

### One

Play the selected file repeatedly.

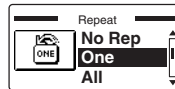

### One

Play the selected file repeatedly.

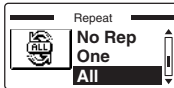

### All

Play all files in folders in SD card repeatedly.

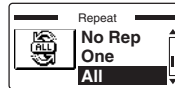

### All

Play all files in the selected folder repeatedly.



### Random

Randomly play all files in folders in SD card repeatedly.



### Random

Randomly play all files in the selected folder repeatedly.



## ● Control



### Control

Slide ►|| button to ▲ / ▼ and slide ►|| button to ►►| shortly once.

Select desirable Song Inf mode and Resume mode sliding ►|| button to ►►|.

### 1) Song Inf

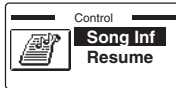

**Song Inf** : Display Song Title, Artist and Album name.

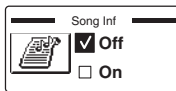

Slide ►|| button to ▲ / ▼ and slide ►|| button to ►►| to select Off/On.

### 2) Resume



**Resume** : Set "Resume" function.

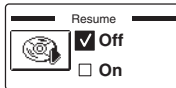

Slide ►|| button to ▲ / ▼ and slide ►|| button to ►►| to select Off/On.





## FM Mode

In the stop(pause) mode, slide and hold ►|| button to ▲ for at least 2 seconds, then select “FM” sliding ►|| button to ▲/▼ and slide ►|| button to ►| to enter FM Mode.



Slide and hold to ▲ for at least 2 seconds

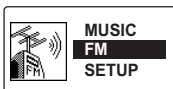

### 1) Selecting FM Mode

You can select 2 kinds of FM mode, Normal Mode and Preset Mode.  
To select Preset Mode, slide ►|| button to ▲.



Slide ►|| button to ▲ shortly.

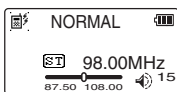

<Normal Mode>

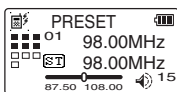

<Preset Mode>

#### Note

- When Preset mode is selected, “Empty” sign will be shown if there’s no saved frequency.
- 10 Stations can be preset.
  - : Station preset
  - : Blank

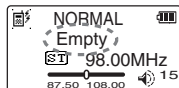



## 2) Searching FM Frequency

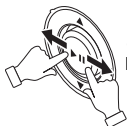

Slide ►|| button to  
◀◀/▶▶ shortly.

**Normal Mode :** Slide ►|| button to ◀◀/▶▶ shortly, then Frequency level changes as 0.05MHz(50kHz) every click.

Slide ►|| button to ◀◀/▶▶ longer, then through automatic scanning, Frequency will be selected at a good reception.

**Preset Mode :** Slide ►|| button to ◀◀/▶▶ shortly, then the channels jump to saved Frequency level.

## 3) Saving FM Frequency

Search the favorable FM frequency in Normal Mode and press ►|| button shortly once. When the station number is displayed, select the number(01~10) sliding ►|| button to ◀◀/▶▶ and press ►|| button shortly to save the frequency.

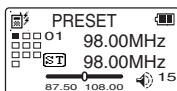
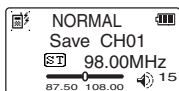

### Note

Once you save the frequency, FM mode is automatically switched to Preset Mode.

Slide ►|| button to ▲ shortly once to return to Normal mode.

## 4) Deleting Preset Channel

Press ►|| button shortly once when the station number to delete is displayed. Select [YES] to delete the station sliding ►|| button to ◀◀/▶▶ and press ►|| button shortly again.

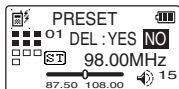



## 6) Entering MENU mode

In FM Mode, slide and hold ►|| button to ▲ for at least 2 seconds, then select “FM” and press ►|| button shortly once to enter.



Slide and hold to ▲ for at least 2 seconds



Slide ►|| button to ◀◀ shortly to return to higher menu.

### ● FM Mode

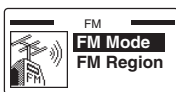

#### FM Mode

Slide ►|| button to ▲ / ▼ and press ►|| button shortly once.

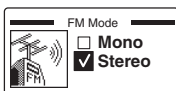

#### FM Mode

Select MONO/STEREO sliding ►|| button to ▲ / ▼ and press ►|| button shortly once.

### ● FM Region



#### FM Region

Slide ►|| button to ▲ / ▼ and press ►|| button shortly once.



**FM Region** : Select reception region sliding ►|| button to ▲ / ▼ .

(Europe, Others)

#### Frequency Range

Europe : 87.5 MHz~108 MHz

Others : 76 MHz~108 MHz







## Setup Mode

Slide and hold ►|| button to ▲ for at least 2 seconds, then select "SETUP" sliding ►|| button to ▲ / ▼ and press ►|| button shortly once.  
Slide ►|| button to ◀◀ shortly to return to higher menu.



Slide and hold to ▲ for at least 2 seconds



### ● Language



#### Language

Slide ►|| button to ▲ / ▼ and press ►|| button shortly once.

Slide ►|| button to ◀◀ shortly to return to higher menu.



#### Language

English, Spanish, German, Italian, French, Russian

### ● Display



#### Display

Select Contrast/Backlight/Power mode sliding ►|| button to ▲ / ▼ and press ►|| button shortly once.

#### 1) Contrast



#### Contrast

Control the contrast on the LCD sliding ►|| button to ▲ / ▼ (01~24) and press ►|| button shortly once.

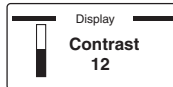



## 2) Backlight

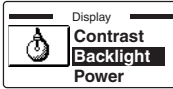

### Backlight

Adjust the period of time sliding ►|| button to ▲/▼ (Off, 01~08, On) and press ►|| button shortly once.

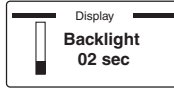

## 3) Power

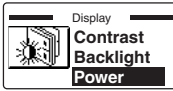

### Power

Set the lead time to auto power off in stop(pause) mode sliding ►|| button to ▲/▼ and press ►|| button shortly once. (On, 01~09min).



## ● System



### System

Select Reset, Del File, Format mode sliding ►|| button to ▲/▼ and press ►|| button shortly once.

## 1) Reset



### Reset

Reset and initialize all the setting as factory default.

Select [Yes] sliding ►|| button to ▲/▼ and press ►|| button shortly once.

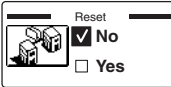



## 2) Del File

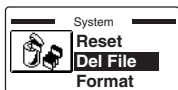

### Del File

MP3/WMA files playback possible are to be able to delete.

Select a file that you want to delete sliding ►|| button to ▲/▼/◀◀/▶▶, then slide and hold ►|| button to ►▶ for at least 2 seconds.

Select [Yes] sliding ►|| button to ◀◀/▶▶ and press ►|| button shortly once.



### Note

- Before deleting, make sure that battery indicator is "Level 2" or "Full".
- Unlock the protect of SD card before deleting.
- Deleting folders is not possible.





### 3) Format

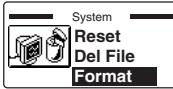

#### Format

After SD card formatted, all data is deleted.  
Select [Yes] sliding ►|| button to ▲ / ▼ .  
Press ►|| button shortly once.



#### Note

- Before format, make sure that battery indicator is "Level 2" or "Full".
- Unlock the protect of SD card before Format.
- Do not remove battery and SD card while formatting.

### ● Inform



#### Inform

Press ►|| button shortly once.



#### FW

Shows the current firmware version.

#### FREE

Shows the memory of SD card remain volume.

#### SIZE

Shows the memory of SD card actual capacity.





## Troubleshooting guide

### Symptom

#### Possible cause

#### Corrective action

The unit does not start.

Battery is not inserted properly or is dead.

Reinsert the battery correctly or replace with new alkaline battery.

SD card error.

Remove a battery after turning off the unit. After wait a moment, insert a battery and turn on the unit again.

(When the symptom doesn't improve it, format the SD card.)

Buttons do not respond.

The hold function is set.

Turn off the function.

The USB cable is still connected.

Disconnect the unit from the PC.

No sound.

The volume is turned down too low.

Adjust the volume.

Files cannot be played (correctly or at all).

The file is not in a playable format.

Use MP3/WMA-format files.

The data which cannot be played on the unit.

Create a file using different encoder (MP3/WMA conversion) software.



---

**Symptom****Possible cause****Corrective action**

---

The Removable Disk is not displayed when the unit is connected to the PC.

The PC and the unit are not connected correctly.

Make sure the connect is corrected.

Disconnect the unit from the PC and reconnect it again.

Sufficient power is not being supplied from the PC.

If a USB hub is being used, reconnect the unit directly to the USB port on the PC. If the PC is equipped with several different USB ports, try another port.

The USB driver is not installed properly.

Check the installation (only for Windows 98SE operating systems, see page 9).

A network drive has been assigned.

If a network drive has been assigned, the drive letter (the letters used as drive names) is already taken, so the Removable Disk cannot be created. Change the network drive assignments and reconnect. Talk to your network administrator about reassigning network drives.

---

A file can't be deleted.

The attribute of the file is set up only for reading.

Please delete a file whether connects this to a PC and changes file attribute.

Or please do format of SD card.

Protect the SD card.

Unlock the protect of SD card.

---





## Cleaning the cabinet

Clean the outside of the unit with a clean soft cloth, moistened with lukewarm water. Do not use benzene, thinner or alcohol since they will mar the finish of the surfaces.



[ENGLISH]

**GB-30**





## [ESPAÑOL]

### Contenido

Precauciones .....	1	Desconectar el grabador de voz del PC .....	12
Precauciones de seguridad .....	2	Antes de utilizar el dispositivo .....	13
Características .....	5	Modo de música .....	17
Controles .....	6	Modo de FM .....	21
Descripción en la LCD .....	7	Modo de configuración .....	24
Entorno de PC recomendado .....	8	Guía de solución de problemas .....	28
Programa de controlador USB .....	9	Limpieza de la carcasa .....	30
Conecte la unidad a su PC .....	11		

### Precauciones

- IBM y PC/AT son marcas comerciales registradas de International Business Machines Corporation.
- Microsoft, Windows Media™ y el logotipo de Windows® son marcas comerciales o marcas comerciales registradas de Microsoft Corporation en los EE.UU. y/o en otros países.
- Windows Media™ Player es una marca comercial o una marca comercial registrada de Microsoft Corporation.
- SD™ es una marca registrada de SD Association.
- Otros nombres de sistemas y de productos son generalmente marcas comerciales registradas o marcas comerciales de sus respectivos fabricantes y desarrolladores. Los símbolos™ y® no se muestran en este manual.
- SANYO no se responsabiliza de ningún daño de grabación derivado de interrupciones en el suministro eléctrico o daños en la unidad.
- Para evitar posibles pérdidas de datos provocadas por un uso accidental o erróneo de la unidad, se recomienda guardar una copia de seguridad de los mensajes grabados en un PC o en otro dispositivo.
- La grabación de material con derechos de autor sin el permiso de los propietarios de dichos derechos suele constituir un delito. Si desea volver a grabar material con derechos de autor, deberá obtener el permiso correspondiente de los propietarios. SANYO no aprueba ni puede hacerse responsable de un uso fraudulento de este aparato.







## Precauciones de seguridad

- Este manual contiene información importante acerca de las precauciones de seguridad y la correcta manipulación del producto para evitar un accidente. Asegúrese de leer atentamente este manual antes de utilizar el producto.
- Guarde este manual en un lugar seguro, donde lo pueda encontrar fácilmente para futura referencia.
- SANYO no se responsabiliza de las pérdidas causadas por el borrado de la memoria del dispositivo si éste se avería, debe repararse o por otras razones.

### Símbolos de advertencia y precaución



#### Advertencia

Si se maltratara, el usuario podría herirse o el producto podría funcionar mal.



#### Precaución

Si se maltratara, el usuario podría sufrir efectos perjudiciales o podrían producirse errores en el sistema.



## Precauciones de seguridad

### Precauciones de almacenamiento

- No utilice ni almacene la unidad en lugares donde las temperaturas sean extremas (Inferiores a  $-5^{\circ}\text{C}$  o superiores a  $35^{\circ}\text{C}$ ).
- Mantenga la unidad lejos del alcance de los niños.
- No almacene el producto en lugares muy húmedos o con mucho polvo.

### Precauciones de uso

- No deje caer el producto y evite que sufra golpes.
- Evite que la pantalla LCD reciba golpes fuertes.
- Extraiga la pila de inmediato si sale humo de la unidad o si ésta se deforma a causa del calor.
- No utilice el producto en lugares en los que esté prohibido utilizar dispositivos electrónicos, como por ejemplo aviones, etc.
- Si ajusta el volumen a un nivel demasiado alto, su capacidad auditiva puede verse afectada.

Ajuste un nivel adecuado de volumen.

Si oye un zumbido en los oídos, reduzca el volumen o deje de utilizar la unidad.

- Hay riesgo de que sufra un accidente de tráfico si utiliza este producto mientras conduce o anda por la calle.
- No desarme el producto.



Los productos SANYO están diseñados y fabricados con materiales y componentes de alta calidad, que pueden ser reciclados y reutilizados.

Este símbolo significa que el equipo eléctrico y electrónico, al final de su ciclo de vida, no se debe desechar con el resto de residuos domésticos.

Por favor, deposite su viejo "televisor" en el punto de recogida de residuos o contacte con su administración local.

En la Unión Europea existen sistemas de recogida específicos para residuos de aparatos eléctricos y electrónicos.

Por favor, ayúdenos a conservar el medio ambiente!



## Precauciones de seguridad

### Precauciones relacionadas con el uso de las pilas

- Asegúrese de utilizar pilas del tipo especificado en este manual (pilas alcalinas AAA).
- El calor por fricción podría incendiar las pilas. Mantenga las pilas alejadas de objetos metálicos, tales como monedas o candados. .
- Extraiga la pila del interior de la unidad si no va a utilizarla durante un período largo de tiempo.
- Compruebe que la polaridad sea correcta (+/-).

#### Nota

Deseche todas las pilas usadas de manera segura y de acuerdo con la legislación aplicable.



### Advertencia

- Si su ropa o su piel se manchan con un electrolito, lávelo con agua de inmediato o consulte qué hacer con su médico.
- Si sus ojos entran en contacto con un electrolito, no los fregue; lávelos con agua limpia de inmediato y consulte qué hacer con su médico.





## Características

- **Ranura de la tarjeta SD**
- **MP3, WMA**
- **Dispositivo portátil de almacenamiento en masa USB**
- **Modo de música – Normal, popular, rock, clásica y jazz**
- **Función de navegación USB fácil de utilizar**
- **FM estéreo**

### Nota:

- Este manual de instrucciones se ha impreso antes del desarrollo final del producto.  
Si es necesario cambiar las funciones o parte de las especificaciones del producto para mejorar su operabilidad, se da prioridad a las propias especificaciones del mismo. En dichos casos, es posible que el manual de instrucciones no coincida completamente con las funciones del producto real. En consecuencia, el producto y el embalaje finales, así como su nombre y las ilustraciones, pueden diferir de lo mostrado en este manual.
- La pantalla LCD que se muestra como ejemplo en este manual puede diferir de la pantalla LCD real.
- DRM9 (Administración de derechos digitales 9) soportado  
No se soporta DRM10

## Accesorios

Cable USB x 1  
CD-ROM x 1  
Auriculares x 1  
Pila alcalina AAA/LR03/HP16



## Controles

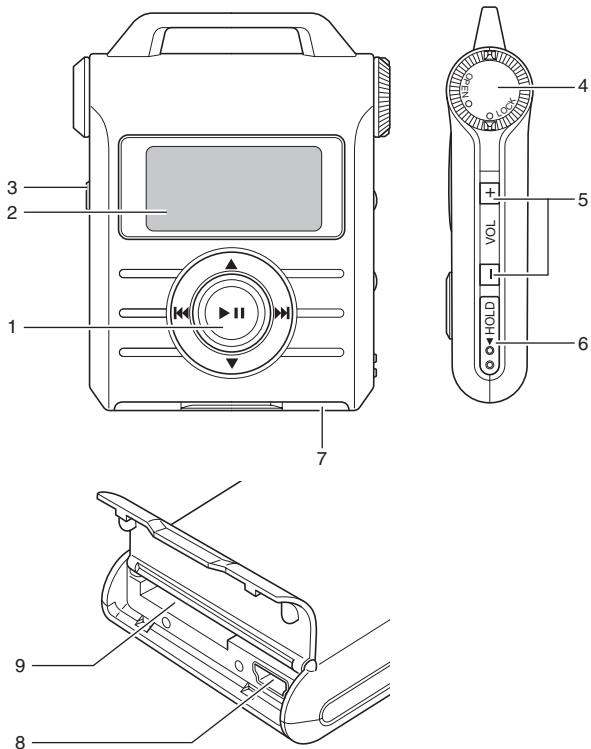

1. Botón ► || (Alimentación/Operación)
2. Pantalla LCD
3. Terminal de auriculares estéreo
4. Tapa del compartimento de la pila
5. Botones de volumen +, -
6. Conmutador de bloqueo (HOLD)
7. Tapa de la ranura de la tarjeta SD
8. Terminal USB
9. Ranura de la tarjeta SD



## Descripción en la LCD

### Música (WMA/MP3)

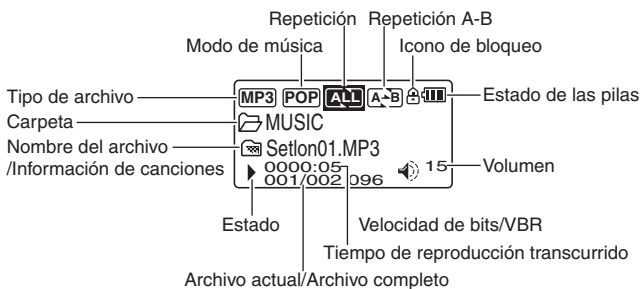

### FM

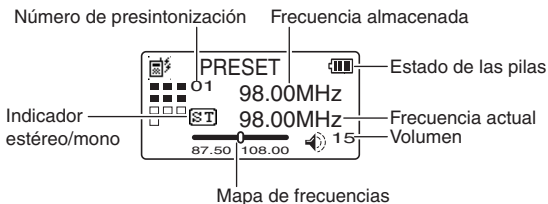



## Entorno de PC recomendado

PC soportados Ordenadores compatibles IBM PC/AT

Sistemas operativos soportados

Windows XP Professional

Windows XP Home Edition

Windows 2000 Professional

Windows Millennium Edition(Me)

Windows 98 Second Edition

Puerto USB

Se requiere uno para la conexión

Tarjeta de sonido

Tarjeta de sonido de 16 bits compatible con Windows

Otros

Se requieren unos altavoces o unos auriculares

Nota:

- No se garantiza el funcionamiento con ordenadores Macintosh.
- No se garantiza el funcionamiento en los entornos siguientes:
  - Futuros entornos de Windows
  - Windows 95, Windows 98, Windows NT
  - Entornos Windows de arranque dual
- No se garantiza el funcionamiento con todos los ordenadores personales, aunque cumplan las especificaciones del entorno recomendado.
- Es posible que los modos en espera, suspendido y otros no funcionen correctamente en su entorno particular. Si experimenta problemas con estos modos, no los utilice.

- Se requiere un controlador USB para Windows 98SE.  
El controlador USB debe instalarse desde el CD-ROM (suministrado) antes de conectar esta unidad a su PC.



## Programa de controlador USB

### Instalar el controlador USB para Windows 98SE

Si usted es usuario de Windows 98SE deberá instalar el controlador USB.

- No debe instalar el controlador USB si dispone de Windows XP/2000/ME.
- Se prohíbe la reproducción de este controlador.
- No se puede copiar ni reproducir este controlador.
- SANYO no se responsabiliza de ningún daño derivado del uso de este controlador.

1. Encienda su PC y arranque Windows. No conecte todavía la unidad al PC.
2. Inserte el CD-ROM del controlador USB (suministrado) en la unidad de CD-ROM del PC. Aparecerá la pantalla de instalación [USB Mass Storage Driver Setup] automáticamente.

Nota:

- Si la pantalla no aparece directamente, haga clic con el botón derecho sobre el botón [Start], seleccione [Explore]. Haga doble clic en el archivo "Setupapp.exe" del CD-ROM. Aparecerá la pantalla de instalación [USB Mass Storage Driver Setup].
- Haga clic en [Uninstall] para retirar el programa del controlador USB de su PC.







3. Haga clic en [Install]. Aparecerá la pantalla del asistente de instalación [Install].

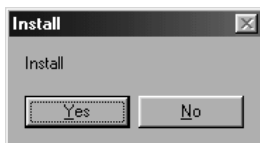

4. Haga clic en [Yes].



4. Haga clic en [OK]. El ordenador se reiniciará.





## Conecte la unidad a su PC

Inserte la tarjeta SD en la ranura de tarjeta SD antes de hacer la conexión a un PC.

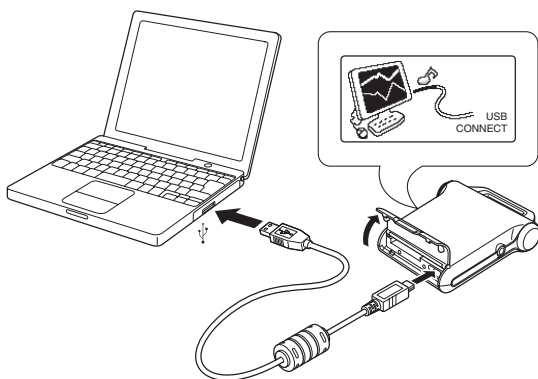

Nota:

- No utilice un concentrador USB o un cable de extensión USB, ya que no podemos garantizar el correcto funcionamiento de la unidad. Utilice solamente el cable de conexión USB incluido con la unidad.
- Si es la primera vez que conecta la unidad al PC, es posible que no se reconozca como disco extraíble. En caso de ocurrir, desconecte la unidad y vuelva a conectarla.
- La unidad funcionará sin batería mientras esté conectada al PC.

- Se requiere un controlador USB para Windows 98SE.  
El controlador USB debe instalarse desde el CD-ROM (suministrado) antes de conectar esta unidad a su PC.





## Desconectar el grabador de voz del PC

Antes de desconectar la unidad del PC, asegúrese de que no se estén transfiriendo datos.

Para Windows 98SE  
Desconecte la unidad del PC.

Para Windows XP/2000/ME  
Siga los pasos siguientes para desconectar la unidad. Las pantallas siguientes son de Windows XP.

- La pantalla puede no ser igual si utiliza un sistema operativo diferente.
1. Haga clic con el botón derecho en el icono de la Barra de tareas, en la parte inferior derecha de la pantalla.



Si el icono no aparece, consulte la Ayuda de Windows.

2. Haga clic en [Safely Remove Hardware].





## Antes de utilizar el dispositivo

### 1) Pila

#### Instalación de la pila

Una pila alcalina AAA/LR03/HP16

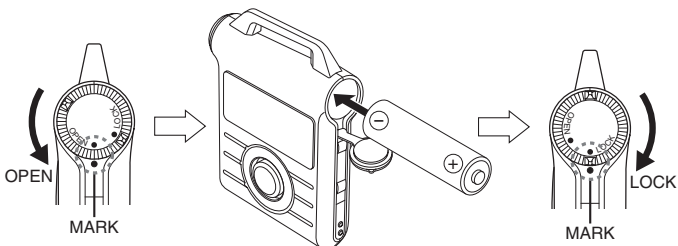

Ajuste las marcas “●” cuando abra o cierre.

#### Icono del estado de la pila



Llena



Nivel 2



Nivel 1



Agotada  
(Tiempo hasta reemplazarla)

#### Duración de la pila

Pila	Reproducción de WMA/MP3	Escucha de FM
Pila AAA	12 horas aproximadamente	9 horas aproximadamente

#### Nota

- La duración de la pila puede ser diferente dependiendo de su tipo, el volumen de la reproducción, etc.
- El ajuste de la desconexión automática de la alimentación es opcional.



## 2) Auriculares (suministrados)

Conecte los auriculares al terminal .

Nota

Asegúrese de reducir el volumen antes de conectar o desconectar los auriculares.

## 3) Tarjeta SD

### Inserción de la tarjeta SD

1. Abra la tapa del compartimiento de la tarjeta SD.
2. Compruebe el borde de la tarjeta e insértela como se muestra.
3. Cierre la tapa.

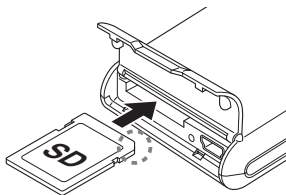

### Extracción de la tarjeta SD

1. Pulse el botón y mantenga pulsado  para conectar la alimentación.
2. Abra la tapa del compartimiento de la tarjeta SD.
3. Empuje suavemente la tarjeta hacia el interior de la ranura para liberarla.
4. Sáquela.

#### Nota

- No extraiga nunca la tarjeta mientras está funcionando la unidad.
- No coloque la tarjeta donde quede expuesta a la electricidad estática o al ruido eléctrico.
- Se puede utilizar una tarjeta SD de 128 MB/256 MB/512 MB/1 GB/2 GB. Algunas tarjetas SD tal vez no puedan utilizarse con esta unidad.
- Ponga el interruptor de protección contra escritura en "Lock" para proteger sus datos.
- No toque los terminales de metal de la tarjeta con sus manos u otros objetos metálicos.

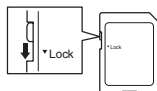



#### 4) Conexión/desconexión de la alimentación

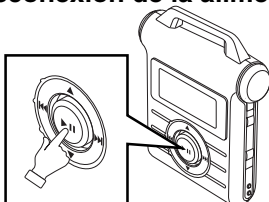

##### Conexión de la alimentación

Pulse y mantenga pulsado el botón ►|| durante un mínimo de 2 segundos, "HELLO!" aparece brevemente en la pantalla y se conecta la alimentación.

##### Desconexión de la alimentación

Pulse y mantenga pulsado el botón ►|| durante un mínimo de 2 segundos, "SEE YOU!" aparece y se desconecta la alimentación.

#### 5) Activación/desactivación del bloqueo

Bloqueo activado = Deslice el conmutador HOLD hacia la izquierda.

Bloqueo desactivado = Deslice el conmutador HOLD hacia la derecha.

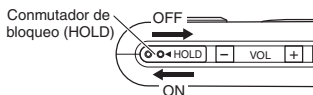

#### 6) Control de volumen

Pulse brevemente el botón +/- para controlar el volumen del sonido.

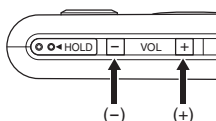



## 7) Modo de conmutación

Deslice y mantenga pulsado el botón ► en ▲ durante un mínimo de 2 segundos para entrar en el modo de conmutación.



Deslícelo y manténgalo en ▲ durante un mínimo de 2 segundos.



<MUSIC>



<FM>



<SETUP>

- 1) **MUSIC** : Reproducción de archivos de música como MP3 y WMA
- 2) **FM** : Radio de FM
- 3) **SETUP** : Ajuste de función

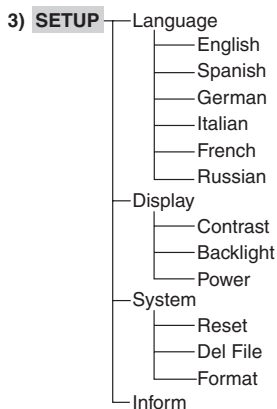
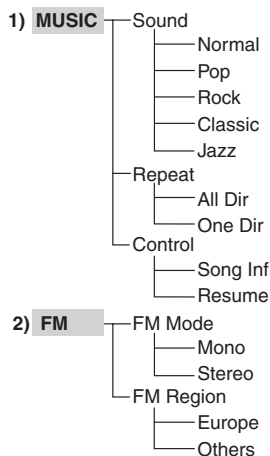



## Modo de música

### 1) Reproducción/Parada (Pausa)



Pulse brevemente el botón ►||

**Reproducción** : Pulse brevemente una vez el botón ►|| .

**Parada (Pausa)** : Pulse brevemente una vez el botón ►|| en el modo de reproducción.



<Reproducción>



<Parada (Pausa)>

### 2) Búsqueda de archivo/Navegación/Selección



**Búsqueda de archivo** : Deslice brevemente/o durante más tiempo una vez el botón ►|| hacia ◀◀/▶▶.

**Navegación** : Deslice brevemente el botón ►|| hacia ▲ .

**Búsqueda**: En el modo de reproducción, deslice y mantenga el botón ►|| en ◀◀/▶▶ durante un mínimo de 2 segundos.

Siempre que pulse el botón, usted podrá pasar a los siguientes archivos.

**Desplazamiento al archivo anterior/siguiente**: Deslice brevemente una vez el botón ►|| a ◀◀/▶▶ en el modo de reproducción.

**Para saltar al archivo anterior/siguiente**: En el modo de reproducción, o en el de parada (pausa), deslice brevemente una vez el botón ►|| a ◀◀/▶▶ . Y seleccione luego el archivo.

**Modo de navegación**: En el modo de reproducción, o en el de parada (pausa), deslice brevemente una vez el botón ►|| a ▲ .

Puede seleccionar el archivo deslizando el botón ►|| a ▲, ▼, ◀◀ o ▶▶ .



#### Nota

En el modo de reproducción, cuando el tiempo de reproducción es inferior a 5 segundos, salte al archivo anterior deslizando brevemente una vez el botón ►|| a ◀◀ .







### 3) Repetición de sección (A-B)



Deslice brevemente el botón **▶ ||** hacia **▲**.

**Activación :** Deslice brevemente una vez el botón **▶ || a ▼** para seleccionar el punto A durante la reproducción.  
Vuelva a deslizar brevemente una vez el botón **▶ || a ▼** para seleccionar el punto B.  
Luego, la sección de A a B se reproducirá repetidamente.

**Desactivación :** Deslice brevemente una vez el botón **▶ || a ▼**.

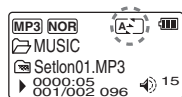

<Fijación del punto A>

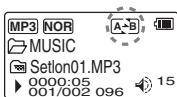

<Fijación del punto B>

### 4) Entrada en el modo MENU

En el modo MUSIC, deslice y mantenga el botón **▶ ||** en **▲** durante un mínimo de 2 segundos, y luego seleccione "MUSIC" y pulse brevemente el botón **▶ ||** para entrar en el menú.



Deslícelo y manténgalo en **▲** durante un mínimo de 2 segundos.



Deslice brevemente el botón **▶ || a ◀◀** para volver a un menú anterior.

#### ● Sonido



#### Sonido

Deslice brevemente una vez el botón **▶ || a ▲ / ▼** y el botón **▶ || a ▶▶**.

Seleccione el tipo de sonido deseado deslizando y manteniendo brevemente una vez el botón **▶ ||** en **▲ / ▼** y el botón **▶ ||** en **▶▶**.

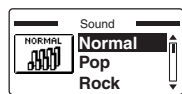

<Normal>

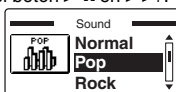

<Pop>

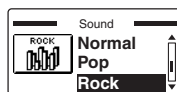

<Rock>



<Classic>

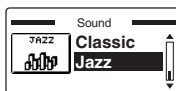

<Jazz>

[ESPAÑOL]





## ● Repetición



### Repetición

Deslice brevemente una vez el botón ►|| a ▲/▼ y el botón ►|| a ►►|.

Selección el modo de repetición deseado deslizando brevemente una vez el botón ►|| a ▲/▼ y el botón ►|| a ►►|.



### Todas las direcciones (All Dir)

Reproduzca todos los archivos de todas las carpetas de la tarjeta SD.

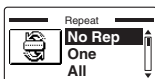

### Sin repetición (No Rep)

Reproduzca todos los archivos de la tarjeta SD una vez.



### Una dirección (One Dir)

Reproduzca los archivos de la carpeta seleccionada.

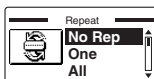

### Sin repetición (No Rep)

Reproduzca todos los archivos de la carpeta seleccionada una vez.

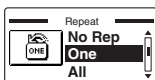

### Uno (One)

Reproduzca repetidamente el archivo seleccionado.

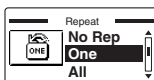

### Uno (One)

Reproduzca repetidamente el archivo seleccionado.



### Todos (All)

Reproduzca repetidamente todos los archivos de las carpetas de la tarjeta SD.



### Todos (All)

Reproduzca repetidamente todos los archivos de la carpeta seleccionada.



### Reproducción aleatoria (Random)

Reproduzca de forma aleatoria y repetida todos los archivos de las carpetas de la tarjeta SD.



### Reproducción aleatoria (Random)

Reproduzca de forma aleatoria y repetida todos los archivos de la carpeta seleccionada.



## ● Control



### Control

Deslice brevemente una vez el botón ►|| a ▲/▼ y el botón ►|| a ►▶|.

Seleccione el modo de información de canciones y el modo de reanudación deseados deslizando el botón ►|| a ►▶|.

## 1) Información de canciones



**Información de canciones** : Visualiza el título de la canción, el nombre del artista y del álbum.



Deslice el botón ►|| a ▲/▼ y el botón ►|| a ►▶| para seleccionar la activación/desactivación.

## 2) Reanudación



**Reanudación** : Active la función de "reanudación".

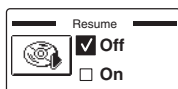

Deslice el botón ►|| a ▲/▼ y el botón ►|| a ►▶| para seleccionar la activación/desactivación.





## Modo de FM

En el modo de parada (pausa), deslice y mantenga el botón ►|| en ▲ durante un mínimo de 2 segundos, y luego seleccione "FM" deslizando el botón ►|| a ▲/▼ y el botón ►|| a ►|| para entrar en el modo de FM.



Deslícelo y manténgalo en ▲ durante un mínimo de 2 segundos.

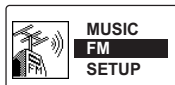

### 1) Selección del modo de FM

Puede elegir 2 clases de modo de FM: modo normal y modo de presintonización. Para seleccionar el modo de presintonización, deslice el botón ►|| a ▲.



Deslice brevemente el botón ►|| hacia ▲.

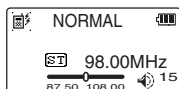

<Modo normal>

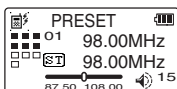

<Modo de presintonización>



#### Nota

- Cuando se seleccione el modo de presintonización aparecerá el signo "Empty" si no hay una frecuencia guardada.
- Se pueden presintonizar 10 emisoras.
  - : Presintonización de emisoras
  - : En blanco

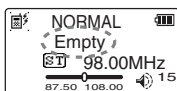



## 2) Búsqueda de frecuencias de FM



Deslice brevemente el botón ►|| hacia ◀◀◀/▶▶▶.

**Modo normal :** Deslice brevemente el botón ►|| a ◀◀◀/▶▶▶ y el nivel de la frecuencia cambiará 0.05 MHz (50 kHz) con cada clic. Deslice más tiempo el botón ►|| a ◀◀◀/▶▶▶ y, mediante la exploración automática, la frecuencia se seleccionará con una buena recepción.

**Modo de presintonización :** Deslice brevemente el botón ►|| a ◀◀◀/▶▶▶ y los canales saltarán al nivel de la frecuencia guardada.

## 3) Almacenamiento de la Frecuencia de FM

Busque la frecuencia de FM apropiada en el modo normal y pulse brevemente una vez el botón ►||. Cuando se visualice el número de la emisora, seleccione el número (01 - 10) deslizando el botón ►|| a ◀◀◀/▶▶▶, y pulse el botón ►|| brevemente para guardar la frecuencia.

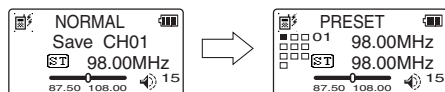

### Nota

Una vez guardada la frecuencia, el modo de FM cambia automáticamente al modo de presintonización.

Deslice brevemente una vez el botón ►|| a ▲ para volver al modo normal.

## 4) Borrado de canales presintonizados

Presione brevemente una vez el botón ►|| cuando se visualice el número de la emisora que va a ser borrada.

Seleccione [YES] para eliminar la emisora deslizando el botón ►|| a ◀◀◀/▶▶▶ y pulse de nuevo brevemente el botón ►||.

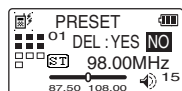



## 6) Entrada en el modo MENU

En el modo de FM, deslice y mantenga el botón ►|| en ▲ durante un mínimo de 2 segundos, y luego seleccione "FM" y pulse brevemente una vez el botón ►|| para entrar en el modo.



Desléclo y manténgalo en ▲ durante un mínimo de 2 segundos.



Deslice brevemente el botón ►|| a ◀◀ para volver a un menú anterior.

### ● Modo de FM



#### Modo de FM

Deslice el botón ►|| a ▲/▼ y pulse brevemente una vez el botón ►||.

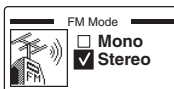

#### Modo de FM

Seleccione MONO/STEREO deslizando el botón ►|| a ▲/▼ y pulse brevemente una vez el botón ►||.

### ● Región de FM



#### Región de FM

Deslice el botón ►|| a ▲/▼ y pulse brevemente una vez el botón ►||.



**Región de FM :** Seleccione la región de recepción deslizando el botón ►|| a ▲/▼ .  
(Europa y otras regiones)

#### Gama de frecuencias

Europa : 87,5 MHz~108 MHz

Otros: 76 MHz~108 MHz





## Modo de configuración

Deslice y mantenga el botón ►|| en ▲ durante un mínimo de 2 segundos, y luego seleccione "SETUP" deslizando el botón ►|| a ▲/▼ y pulse brevemente una vez el botón ►||.

Deslice brevemente el botón ►|| a ◀◀ para volver a un menú anterior.



Deslécilo y manténgalo en ▲ durante un mínimo de 2 segundos.



### ● Idioma



#### Idioma

Deslice el botón ►|| a ▲/▼ y pulse brevemente una vez el botón ►||.

Deslice brevemente el botón ►|| a ◀◀ para volver a un menú anterior.



#### Idioma

Inglés, español, alemán, italiano, francés, ruso

### ● Visualización



#### Visualización

Seleccione el modo de contraste/luz de fondo/alimentación deslizando el botón ►|| a ▲/▼ y pulsando brevemente una vez el botón ►||.

#### 1) Contraste

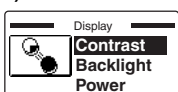

#### Contraste

Controle el contraste de la LCD deslizando el botón ►|| a ▲/▼ (01~24) y pulse brevemente una vez el botón ►||.

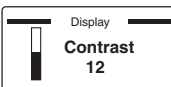



## 2) Luz de fondo



### Luz de fondo

Ajuste el periodo de tiempo deslizando el botón ►|| a ▲ /▼ (desactivación, 01~08, activación) y pulse brevemente una vez el botón ►||.

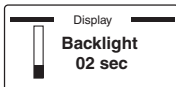

## 3) Alimentación



Establezca el tiempo que va a pasar hasta la desconexión automática de la alimentación, estando en el modo de parada (pausa), deslizando el botón ►|| a ▲ /▼ y pulse brevemente una vez el botón ►||. (Activación, 01~09 minutos).



## ● Sistema



### Sistema

Seleccione el modo de restablecer, eliminar archivo y formatear deslizando el botón ►|| a ▲ /▼ y pulse brevemente una vez el botón ►||.

### 1) Restablecer



### Restablecer

Restablezca e inicialice los ajustes predeterminados en la fábrica.

Seleccione [Yes] deslizando el botón ►|| a ▲ /▼ y pulse brevemente una vez el botón ►||.

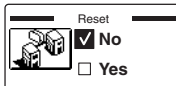





## 2) Eliminar archivo



### Eliminar archivo

Los archivos MP3/WMA de reproducción se pueden borrar.

Seleccione un archivo que quiera eliminar y deslizando el botón ►|| a ▲ / ▼ / ◀◀ / ▶▶, y luego deslice y mantenga el botón ►|| en ▶▶ durante un mínimo de 2 segundos.

Seleccione [Yes] deslizando el botón ►|| a ◀◀ / ▶▶ y pulse brevemente una vez el botón ►||.

### Nota

- Antes de eliminar un archivo, asegúrese de que el indicador de la pila esté en "Nivel 2" o en "Llena".
- Desbloquee la protección de la tarjeta SD antes de eliminar archivos.
- No es posible eliminar carpetas.



### 3) Formatear

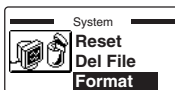

#### Formatear

Después de formatear la tarjeta SD se eliminarán todos los datos.

Seleccione [Yes] deslizando el botón ► II a ▲ / ▼ .

Pulse brevemente una vez el botón ► II .

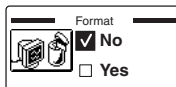

#### Nota

- Antes de formatear, asegúrese de que el indicador de la pila esté en "Nivel 2" o "Llena".
- Desbloquee la protección de la tarjeta SD antes de formatear.
- No extraiga la pila ni la tarjeta SD mientras formatea.

### ● Informar



#### Informar

Pulse brevemente una vez el botón ► II .

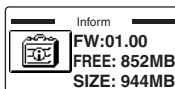

#### FW (Firmware)

Muestra la versión del firmware actual.

#### FREE (Espacio libre)

Muestra la capacidad libre de la memoria de la tarjeta SD.

#### SIZE (Tamaño)

Muestra la capacidad actual de la memoria de la tarjeta SD.



## Guía de solución de problemas

### Síntoma

#### Posible causa

#### Acción correctora

La unidad no se pone en funcionamiento.

Las pilas no están colocadas correctamente o están gastadas.

Coloque la pila correctamente o cámbiela por una pila nueva.

Error de tarjeta SD.

Retire la pila después de apagar la unidad. Después de esperar un momento, inserte la pila y vuelva a encender la unidad.

(Cuando no mejore el síntoma, formatee la tarjeta SD.)

Los botones no responden.

La función de retención está activada.

Desactive la función.

El cable USB aún está conectado.

Desconecte la unidad del PC.

No hay sonido.

El volumen está ajustado al mínimo.

Aumente el volumen.

Los ficheros no se pueden reproducir correctamente (o no se reproducen, ni bien ni mal).

El formato del fichero no se puede reproducir.

Utilice ficheros con formato MP3 o WMA.

Los datos que no se podrán reproducir en la unidad.

Cree un fichero utilizando otro software de codificación (de conversión a MP3 o WMA).



---

## Síntoma

### Posible causa

#### Acción correctora

---

La unidad está conectada al PC y el Disco extraíble no aparece.

El PC y la unidad no están conectadas correctamente.

Compruebe que la conexión es correcta.

Desconecte la unidad del PC y vuelva a conectarla.

El PC no suministra energía suficiente a la unidad.

Si se está utilizando un condensador USB, conecte la unidad directamente al puerto USB del PC. Si el PC está equipado con más de un puerto USB, pruebe con otro puerto.

El controlador USB no está instalado correctamente.

Compruebe la instalación del controlador (sólo para los sistemas operativos Windows 98SE; consulte la página 9).

Se ha asignado una unidad de red.

Si se ha asignado una unidad de red, la letra de la unidad (las letras usadas como nombres de las unidades) ya está ocupada, por lo que no se puede crear el Disco extraíble. Cambie las asignaciones de la unidad de red y reconecte la unidad al PC. Diríjase a su administrador de red para conocer cómo reasignar unidades de red.

---

No se puede eliminar un archivo.

El atributo del archivo está ajustado en sólo lectura.

Elimine un archivo si se conecta a un PC o si se cambia el atributo de archivo.

O formatee la tarjeta SD.

Proteja la tarjeta SD.

Desbloquee la protección de la tarjeta SD.

---



## Limpeza de la carcasa

Limpe el exterior de la unidad con un paño suave humedecido en agua templada. No utilice benceno, diluyentes ni alcohol, ya que podrían dañar la capa protectora de la superficie.



[ESPAÑOL]

**E-30**





**MEMO**





**MEMO**





## Specifications

Internal memory : None (SD card slot)

Frequency response (playback): 20Hz - 20kHz

Music playback capability:

MP3 [MPEG1, 2 Layer3] [MPEG2.5] (16 - 44.1kHz, 8 - 320kbps)

WMA [Windows Media Audio] (16 - 44.1kHz, 32 - 192kbps)

Tuner reception frequency: FM: 76.0 - 108 MHz / 87.5 - 108 MHz

Terminals: USB,  (Headphones)

Output power: 10mW + 10mW

Power source : DC 1.5V AAA/LR03/HP16 battery x 1

Battery Lifetime : WMA/MP3 (playback) Approx. 12Hours

FM Approx. 9Hours

Dimensions (W x H x D): Approx. 55 x 69 x 15 mm

Weight : Approx. 29g (without battery)

### IMPORTANT INFORMATION

Because its products are subject to continuous improvement, SANYO reserves the right to modify product designs and specifications without notice and without incurring any obligation.

This set complies with the EMC Directive 89/336 and with the LVD Directive 73/23.

Este aparato cumple con la Directiva EMC 89/336 y con la Directiva LVD 73/23.

# SANYO

(XE0) 86485-200-002

SANYO Electric Co., Ltd.