

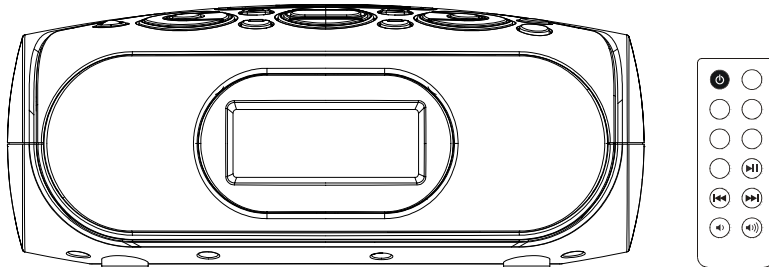

INSTRUCTION MANUAL

DMP-P7

Clock Radio with dock for iPod



Please take good note of the following instructions:

- The unit must be connected to the power voltage which is the same as the local area. If not, there is a danger of "burning" the unit that causes a fire.
- Do not expose to the temperature higher than 35°C.
- Avoid installation near heaters or in areas subjected to direct sunlight.
- Ensure good air circulation.
- Protect the unit from dust, moisture and water.
- Avoid strong magnetic fields, e.g. near TVs or Speakers for other units.
- Avoid using strong chemical agents to clean.
- Do not grease or oil components, running mechanisms, etc. The CD player is designed to be maintenance free.
- Take the unit to approved service point for servicing.

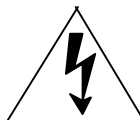
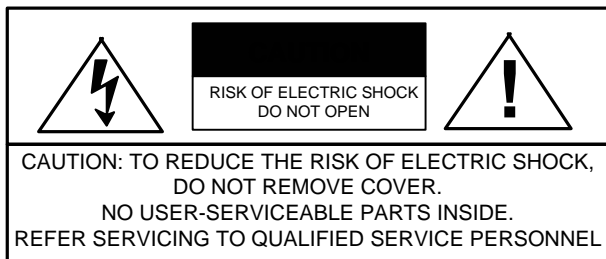

This symbol indicates that dangerous voltage constituting a risk of electric shock is present within this unit.



This symbol indicates that there are important operating and maintenance instructions in the literature accompanying this unit.

CAUTION:

- The product shall not be exposed to dripping or splashing and that no objects filled with liquids, such as vases, shall be placed on the product.
- The normal ventilation of the product shall not be impeded for intended use.
- Do not place naked flame sources, such as lighted candles, on the apparatus.
- The ventilation should not be impeded by covering the ventilation openings with items, such as newspapers, tablecloths, curtains, etc.
- Do not place the product in closed bookcases or racks without proper ventilation.
- Where the mains plug or an appliance coupler is used as the disconnect device, the disconnect device shall remain readily operable. (for example: main plug is used as the connection, so it should always remain ready operate.)
- Minimum distances around the apparatus for sufficient ventilation;
- Before scrapping the appliance, remove the batteries and place them in the appropriate battery collection container.
- Batteries (battery pack or batteries installed) shall not be exposed to excessive heat such as sunshine, fire or the like.
- Excessive sound pressure from earphones and headphones shall not be used to avoid hearing loss.
- The apparatus shall not be exposed to dripping or splashing.
- Do not install this equipment in a confined space, such as a bookcase or built-in cabinet.

Before operating the system, check that the operating voltage indicated on the model plate at your system bottom is identical with the voltage of your local power supply. If not, please consult your dealer.

SOME DO'S AND DON'TS ON THE SAFE USE OF EQUIPMENT

This equipment has been designed and manufactured to meet European safety standards but like any electrical equipment, care must be taken if you are to obtain the best results and safety is to be assured.

DO read the operating instructions before you attempt to use the equipment.

DO ensure that all electrical connections (including the mains plug, extension leads and interconnections between piece of equipment) are properly made in accordance with the supplied instructions. Switch off and withdraw the mains plug when making or changing connections.

DO consult your dealer if you are ever in doubt about the installation, operation, or safety of your equipment.

DO be careful with glass panels or doors on equipment.

DON'T continue to operate the equipment if you are in any doubt about it working normally, or if it is damaged, in any way - switch off, withdraw the mains plug and consult your dealer.

DON'T remove any fixed cover as this may expose dangerous voltages.

DON'T leave equipment switched on when it is unattended unless it is specifically stated that it is designed for unattended operation or has a standby mode. Switch off using the switch on the equipment and make sure that your family knows how to do this. Special arrangements may need to be made for infirm or handicapped people.

DON'T listen to headphones at high volume, as such use can permanently damage your hearing.

DON'T obstruct the ventilation of the equipment, for example with curtains or soft furnishings. Overheating will cause damage and shorten the life of the equipment.

DON'T allow electrical equipment to be exposed to rain or moisture.

Above all

- NEVER let anyone, especially children, push anything into holes, slots or any other openings in the case. This could result in a fatal electric shock.
- NEVER guess or take chances with electrical equipment of any kind.
- It is better to be safe than sorry!

Note : If energy saving lamps (Fluorescent) are used in the same room as the unit, erratic operation may occur.

Controls and Indicators

1. Speaker
2. LCD Display
3. SKIP ►►/◄◄ FORWARD/BACKWARD
4. Buttons
5. AUX Button
6. Dock
7. ALARM 1 Button
8. WAKE Button
9. VOLUME UP/DOWN Buttons
10. SLEEP Button
11. ST/MONO Button
12. ALARM 2 Button
13. SNOOZE/DIMMER Button
14. iPod PLAY/PAUSE Button
15. BAND/RADIO Button
- POWER Button

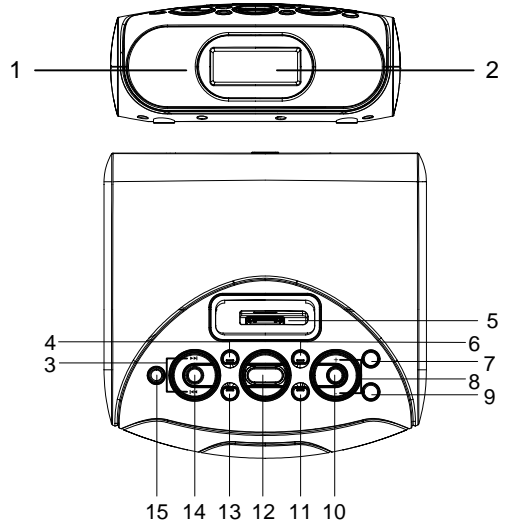

16. Battery compartment
17. AC Cord
18. AUX OUT Jack
19. CLOCK Button
20. AM Loop Antenna Socket
21. AUX IN Jack
22. FM Antenna Wire

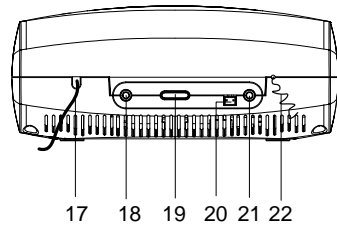
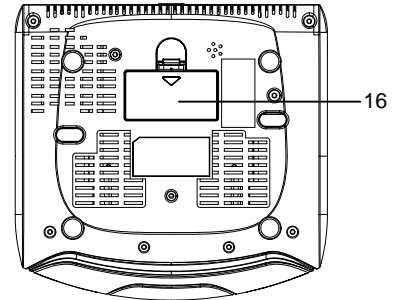

Getting Started

Thank-you for choosing the SANYO DMP-P7 Dual alarm clock PLL radio with iPod.

Designed specifically to work with your docking iPod, this system provides high quality audio and radio performance that brings out the best in your music. An auxiliary input enables connection of a non-iPod.

Please read this instruction book carefully before operating the DMP-P7, and keep it for future reference.

iPod Inserts

Your clock radio comes with removable inserts to ensure your iPod fits properly in the dock on the top of the system.

Due to new iPod models, new inserts subject to availability.

Thin iPods Insert		Thick iPods Insert		Nano Insert	
iPod 3 Gen	10-15 GB	iPod 3 Gen	30 GB	iPod Nano	2 GB
iPod 3 Gen	20 GB	iPod 3 Gen	40 GB	iPod Nano	4 GB
iPod 4 Gen	20 GB	iPod 4 Gen	40 GB		
iPod Photo	30 GB	iPod Photo	40 GB		
		iPod Photo	60 GB		

To place an insert:

1. Select the insert for your iPod. Using the correct insert ensures the proper fit for your iPod.
2. Gently press the iPod insert into the dock.
3. Carefully place your iPod into the dock. (The iPod must not be in a case or "skin").
4. To remove/replace an insert, first remove your iPod, then grip the insert and pull gently upwards.

Install AM loop antenna

Plug the AM loop antenna into the connector located on the back of the unit for AM band radio operation. For best reception, please move the AM antenna 12" away from the unit and iPod.

Getting Started

Install/Replace Backup Battery

The clock radio uses a backup battery system to provide continuous alarm operation and clock settings in the event of a power failure. If the Backup Battery has been installed and a power failure occurs or the AC cord is accidentally disconnected, the display will not remain lit, but the current time and alarm time settings will be temporarily maintained. Otherwise, you must reset the time and alarm settings.

1. Please make sure the AC cord is connected. Otherwise all settings may be lost during battery replacement.
2. Open the battery compartment cover located on the bottom of the unit.
3. Insert 2 "AA" batteries, checking that the polarity (+ and - ends of the batteries) matches the drawing inside the battery compartment. We recommend the use of alkaline batteries for longer life. Different types of batteries or new and used batteries are not to be mixed.
4. Close the compartment cover.

Batteries information:



- Do not mix old and new batteries.
- Do not mix alkaline, standard (carbon-zinc) or rechargeable (nickel-cadmium) batteries.

Maintenance

- Place the unit on a level surface away from sources of direct sunlight or excessive heat.
- Protect your furniture when placing your unit on a natural wood and lacquered finish. A cloth or other protective material should be placed between it and the furniture.
- Clean your unit with a soft cloth moistened only with mild soap and water. Stronger cleaning agents, such as Benzine, thinner or similar materials can damage the surface of the unit.

Before Operation

Turning the power on and off

- Press the  / STANDBY button to turn on the power, the display lights.
- To turn the power off, press the  / STANDBY button again.
- When the mains lead is connected to the AC outlet, the unit will respond to commands from the remote controller.

CONNECTIONS

Note:

- Do not connect the main lead to an AC outlet until all connection have been made.
- The system is not completely disconnected from the mains when the  / STANDBY button is set to the position (standby mode).

Using The Remote Control Unit

Install/Replace the Remote Control Battery

The remote control battery is already installed at the factory. When the remote control stops operating, replace the battery with a new one.

1. The battery door is located on the back end of the unit.
2. Squeeze notched tab A while pulling battery door latch B to release the battery door latch and take out the battery holder.
3. Insert a "CR2025" 3-volt lithium battery. Make sure the polarity (the + and - side of the battery) is correct.
4. Replace the battery holder back in the remote control.

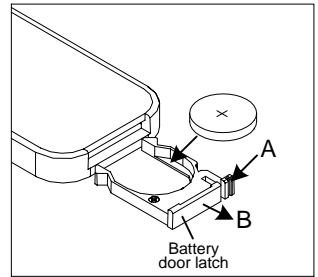

NOTE: PLEASE DISCARD BATTERIES PROPERLY

The Remote Control controls basic functions on the clock radio. For best results, aim remote control towards the grill by the lower right corner of the display.

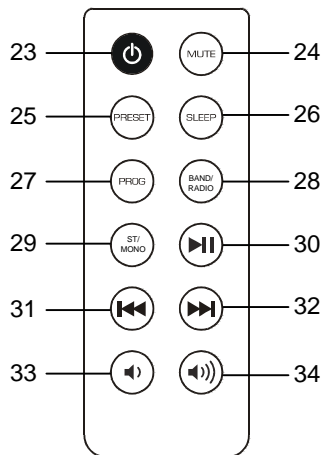

- | | |
|----------------------------|---|
| 23. POWER ON/OFF Button | Turns clock radio ON or OFF or reset alarm when alarm is sounding |
| 24. MUTE Button | Mutes the sound |
| 25. PRESET Button | Selects preset radio stations |
| 26. SLEEP | Selects sleep function |
| 27. PROG Button | Stores radio program |
| 28. BAND/RADIO Button | This button switches between AM and FM radio bands. |
| 29. ST/MONO Button | Switches the receiver between FM stereo and mono modes. Mono reduces the noise heard when listening to weak FM stations. |
| 30. iPod PLAY/PAUSE Button | iPod and plays track. In play mode, press to pause. |
| 31. ⏮ Button | Skip to previous or next track when iPod is playing, or HOLD to scan current playing track. In radio mode, press to tune stations. HOLD to scan radio stations. |
| 32. ⏭ Button | |
| 33. VOLUME - Button | Lowers volume level |
| 34. VOLUME + Button | Raises volume level |

Clock Display

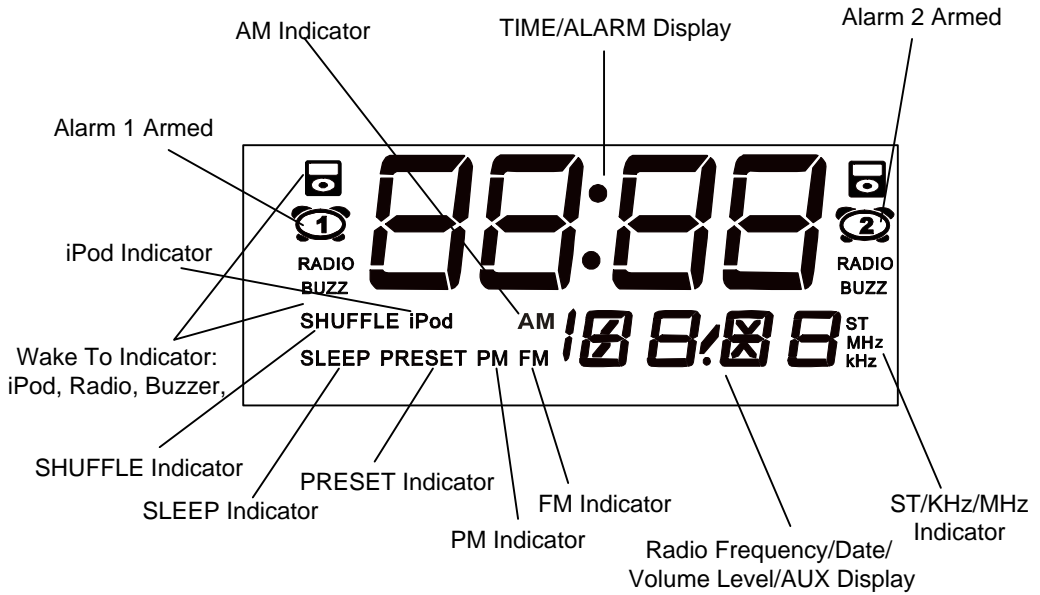

Setting Up the Clock Radio

Setting Clock Time and Calendar

1. Press and hold the **CLOCK Button** located on the back of the unit until 12H or 24H appeared. Select your desired clock display either 12 hour or 24 hour by pressing **SKIP FORWARD or BACKWARD Button** repeatedly. Then press the **CLOCK Button** again to confirm 12H or 24H mode setting.
2. The clock display at the centre will flash. Press the **SKIP FORWARD or BACKWARD Button** to set the current time, then press the **CLOCK Button** again to confirm clock setting. (Note: if the system is set to 12-hour mode, if it's afternoon, the PM indicator will be lighted on.)
3. The year display at the lower right will flash. Press the **CLOCK Button** to accept the current setting, or press the **SKIP FORWARD or BACKWARD Button** until current year is displayed. Press the **CLOCK Button** to confirm year setting.
4. The date display at the lower right will flash. Press the **CLOCK Button** to accept the current setting or press the **SKIP FORWARD or BACKWARD Button** until current date is displayed. Press the **CLOCK Button** to confirm date setting.

Setting Alarm Time

1. The unit can set two Alarm Time.
2. Press and hold the **ALARM 1 Button** or **ALARM 2 Button** until the display flashes. Press the **SKIP FORWARD or BACKWARD Button** until the desired alarm time is displayed. Remember to set the correct AM or PM (an icon to the right of the time display is the PM indicator).
3. Press the **WAKE Button** to select the iPod, radio or alarm buzzer hi or low to wake to.
A corresponding Wake Icon will light up for the selected Wake sound.
To select Buzzer Hi or Low
4. Press and hold **ALARM 1** or **ALARM 2** Button until clock display flashing, press **ALARM 1** or **ALARM 2** Button again. Then select AL-L or AL-H by pressing **SKIP ◀◀** or **▶▶** repeatedly. Press the **ALARM 1 Button** or **ALARM 2 Button** again to exit the setting mode. The alarm time and wake to mode are set.

Note: Once you set the alarm time, the alarm will be automatically armed. The Alarm Icon and Wake Icon will appear to indicate the alarm is armed.

Note: Make sure to adjust volume level for comfortable wake up volume.

Charging your iPod

Note: Please make sure you are using the correct insert for your iPod and that it is properly docked into the clock radio. Failure to do so may damage your iPod.

1. While your iPod is docked in the system, it recharges (until fully charged). Note that other non-docking iPods will NOT charge.
 - Please note that this unit will not recharge iPod 1G, 2G and 3G.

Listening to your iPod

1. Dock the already playing iPod. The clock radio will automatically turn on and you will hear the music playing from your iPod.

Note: If the playing song/music loudness is too low, clock radio may not detect iPod is in play mode. Press the **PLAY/PAUSE Button** on the clock radio (or **PLAY/PAUSE Button** on the remote control) twice to play it.

2. When the iPod is docked and in standby mode, press the **PLAY/PAUSE Button** on the clock radio (or **PLAY/PAUSE Button** on the remote control) to play it. The iPod Icon will appear on the clock radio LCD display, showing iPod Playing mode.
3. Press the **PLAY/PAUSE Button** again to pause play; press again to resume play.
4. Press the **VOLUME UP or DOWN** on the clock radio (or **Volume + and Volume - Button** on the remote control) to adjust the system volume.
5. Press the **MUTE Button** on the remote control to turn OFF the sound. Press the **MUTE Button** again or **Volume +/- buttons** on Handset to restore the sound.
6. Press **◀◀ or ▶▶ Button** to go to the next or previous track. Press and hold while track is playing for high speed forward or reverse music search of the current track.
7. To turn off the unit, press the **POWER Button** or **POWER ON/OFF Button** on remote control to turn it off. The iPod will continue charging while in the dock.

Listening to a non-docking iPod or other portable audio devices

If you are using an iPod without a docking port or other MP3 player or other portable audio device, you can still play it through the clock radio via the AUX IN Jack.

NOTE: To use the AUX IN Jack, make sure no iPod is docked in the clock radio.

1. Plug one end of the audio connecting cable into the **AUX OUT Jack** on your device and the other end of the connecting cable into the clock radio **AUX IN Jack**, located on the back of the unit.
2. Press the **PLAY/PAUSE Button** on the clock radio (or **PLAY/PAUSE Button** on the remote control). The **AUX Icon** will appear, indicating AUX playing mode.
3. Turn on and play your device.
4. Press the **VOLUME UP or DOWN** on the clock radio (or **Volume+ and Volume- Button** on the remote control) to adjust the system volume. You may need to adjust your device volume, too.
5. To turn off the unit, press the **POWER Button** (or **POWER ON/OFF Button** on the remote control). Please remember to turn off your device, too.

Listening to Radio

Note: Extend FM wire antenna fully for best FM reception (do not strip, alter or attach to other antennas). The AM loop antenna should be placed up to 12" away from the unit for best reception. Rotate the AM loop antenna as required for best AM reception.

1. Press the **BAND/RADIO Button** on the clock radio to play the radio. The radio frequency appears at the lower of the display. Press the **BAND/RADIO Button** on the clock radio repeatedly to select AM or FM band.
2. Press the **SKIP FORWARD or BACKWARD Button** on the clock radio (or **◀◀ or ▶▶ Button** on the remote control) to tune in the desired station. Press the **◀◀ or ▶▶ Button** on the remote control again to Auto scan to the next clear station. Hold for seek mode.
3. Press the **ST/MONO Button** (or **ST/MONO** on the remote control) to ST/MONO switches the receiver between FM stereo and mono modes. Mono reduces the noise heard when listening to weak FM stations.
4. Press the **VOLUME UP or DOWN Button** on the clock radio (or **Volume+ and Volume- Button** on the remote control) to adjust the system volume.
5. Press the **MUTE Button** on the remote control to turn OFF the sound. Press the **MUTE Button** again or **Volume +/- buttons** on Handset to restore the sound.
6. To turn off the unit, press the **POWER Button** (or **POWER ON/OFF Button** on the remote control) to turn it off.

Storing preset stations

The unit enables you to program 10 stations of FM and 10 stations of AM band.

1. Press the **SKIP FORWARD or BACKWARD Button** on the clock radio (or **◀◀** or **▶▶ Button** on the remote control) to tune to the station you wish to store.
2. Press the **PROG Button** once on the remote.
3. Press the **PRESET Button** repeatedly on remote to select a preset number to store the station.
4. Press the **PROG Button** again to store station in chosen preset.

RECALLING PRESET STATION

Press the **PRESET Button** on remote control repeatedly to select the desired station.

Alarm Operation

NOTE: TO WAKE TO IPOD, YOUR IPOD MUST BE PROPERLY DOCKED AND OFF (NOT IN PLAY MODE) OR NO ALARM WILL SOUND.

1. Set the alarm time per Setting Alarm time. To preview the alarm time, just press the **ALARM 1 Button** or **ALARM 2 Button** once.
2. You can change the sound mode you wish to wake to at any time by pressing the **WAKE Button**.
3. Press the **ALARM 1 Button** or **ALARM 2 Button** again to arm or disarm the alarm.
4. When the alarm is sounding, press the **POWER Button** on the clock radio (or **POWER ON/OFF Button** on the remote control) to turn the alarm OFF. The alarm will come on again the next day at the same time.
5. To stop the alarm from coming on the following day, press the **ALARM 1 Button** or **ALARM 2 Button** to turn it OFF. The Alarm Icon and Wake Icon will disappear to indicate the alarm is disarmed.
If the alarm is not turned off after it sounds it will play for approximately 1 hour then turn off automatically.
6. This cycle will repeat every 24 hours unless the controls are changed.

Note: When you select Wake To iPod, please make sure your iPod has enough songs to play for 1 hour, otherwise please set the iPod repeat mode to ON.

Note: If you select Wake To iPod but no iPod is present or there is no music on the iPod at alarm time, the clock radio will automatically switch to buzzer alarm.

Sleep Operation

1. When the clock radio is off or while listening to your iPod or the radio, press the **SLEEP Button** to enter sleep mode. The unit will automatically turn off after the selected time. Sleep mode has a Gentle Sleep feature which gradually lowers the volume.
2. You can adjust the sleep timer from 120, 90, 60, 30, 15 minutes by pressing the **SLEEP Button** again. Pressing the **SLEEP Button** while sleep is set to 30 minutes will turn off the unit.
3. When the display changes back to show the real time, pressing the **SLEEP Button** once will show the sleep time remaining. Pressing it again will change sleep time to the next lowest increment.
4. Clock radio has independent volume setting for sleep for sleep mode so you can adjust the sleeping volume without affecting the alarm volume. Press the **VOLUME UP or DOWN** (or press **Volume+ and Volume- Button** on the remote control) to adjust sleep volume. The sleep volume will remain at that level the next time the you enter sleep mode until controls are changed.
5. To stop listening at any time, press the **POWER Button** (or **POWER ON/OFF Button** on the remote control).

Snooze/Dimmer Operation

1. Press the **SNOOZE/DIMMER Button** on the clock radio after the alarm sounds. The alarm will go off and will come on again in approx. 9 minutes. You may repeat this cycle several times during the 1 hour alarm cycle.
2. During normal operation, press the **SNOOZE/DIMMER Button** to control the brightness of the LCD display.

AUX Out Operation

You can connect the clock radio to another line-level device such as an amplifier or recording device through the **AUX OUT Jack** located at the back of the unit. The volume setting on the clock radio does not affect the line level. Adjust volume level using the volume control on the device you connect to.

Troubleshooting

Symptom	Possible Problem	Solution
Unit doesn't respond (no power)	AC cord isn't plugged into a wall outlet.	Plug the AC cord into a wall outlet.
	Wall outlet is not functioning	Plug another device into the same outlet to confirm the outlet is working
iPod does not dock properly	Using no or wrong iPod insert	Make sure the dock insert is the proper fit for your iPod
	iPod didn't install properly	Remove your iPod from the dock and check for obstruction on the connectors in the dock and on your iPod. Then reseal it in the dock.
iPod does not respond to the unit	iPod is not installed properly	Remove your iPod from the dock and check for obstruction on the connectors in the dock and on your iPod. Then reseal it in the dock.
	Your iPod software is too old	Upgrade software on your iPod. For details visit http://www.apple.com/ipod/download
	iPod is locked up	Please make sure your iPod is working properly before docking into the unit. Please refer to your iPod manual for details.
	Using 1 st or 2 nd generation iPod, other devices.	Clock radio cannot control those iPods or other devices.

Troubleshooting

Symptom	Possible Problem	Solution
iPod didn't charge up	iPod is not installed properly	Remove your iPod from the dock and check for obstruction on the connectors in the dock and on your iPod. Then reseat it in the dock.
	iPod is locked up/frozen	Please make sure your iPod is working properly before docking into the unit. Please refer to your iPod manual for details.
No AM band radio sound but others OK	AM loop antenna is not connected to the unit	Plug the AM loop antenna connector to the jack on the back of the unit
AM band radio is very noisy	AM loop antenna isn't located properly	Move the AM loop antenna away from the main unit and rotate it for best reception
Sound is distorted	Volume level is set too high	Decrease the volume
	Sound source is distorted	If the iPod original sound source (MP3) is of poor quality, distortion and noise are easily noticed with high-power speakers. Try a different audio source such as a music CD, (via the aux socket).
Remote Control didn't work	Battery weak	Replace current battery with new battery
	Remote Control is not pointed toward to the clock radio	Point the Remote Control toward the clock radio, move within 10 feet of the unit.
Unit gets warm after extended play at high volume	This is normal	Turn unit off for a while or lower volume
Can't hear speakers attached to aux out jack	Speakers lack power source	The signal from the aux out jack needs amplification. Use powered speakers/monitors or other amplified audio device.

SPECIFICATIONS

GENERAL

Power requirement	AC 240V ~ 50Hz
	DC 3V "AA" size/UM-3 x 2 pcs for Tuner MEMORY back up
	DC CR2025 3V lithium battery for Remote control handset
Power consumption	AC 18 Watts
Dimension	Unit 206 (W) x 195 (D) x 85 (H)mm

RECEIVER SECTION

Receiving bands	AM/FM
Tuning range	AM 522 - 1620KHz, 9KHz/STEP
	FM 87.5 - 108MHz, 50KHz/STEP

AUDIO SECTION

Power output	2 Watts per channel
Speaker impedance	4 ohms
AUX input sensitivity	1000 mV

ACCESSORIES

Power AC cord	1 PC
Instruction Manual	1 PC
Insert	3 PC
Remote Control handset with battery	1 PC
AM loop antenna	1 PC
Patch card	1 PC
3.5 & 3.5mm plug cable	1 PC

Specifications subject to change without notice.

