

SANYO

INSTRUCTION MANUAL

DC-AVD8501

DVD Home Theater System

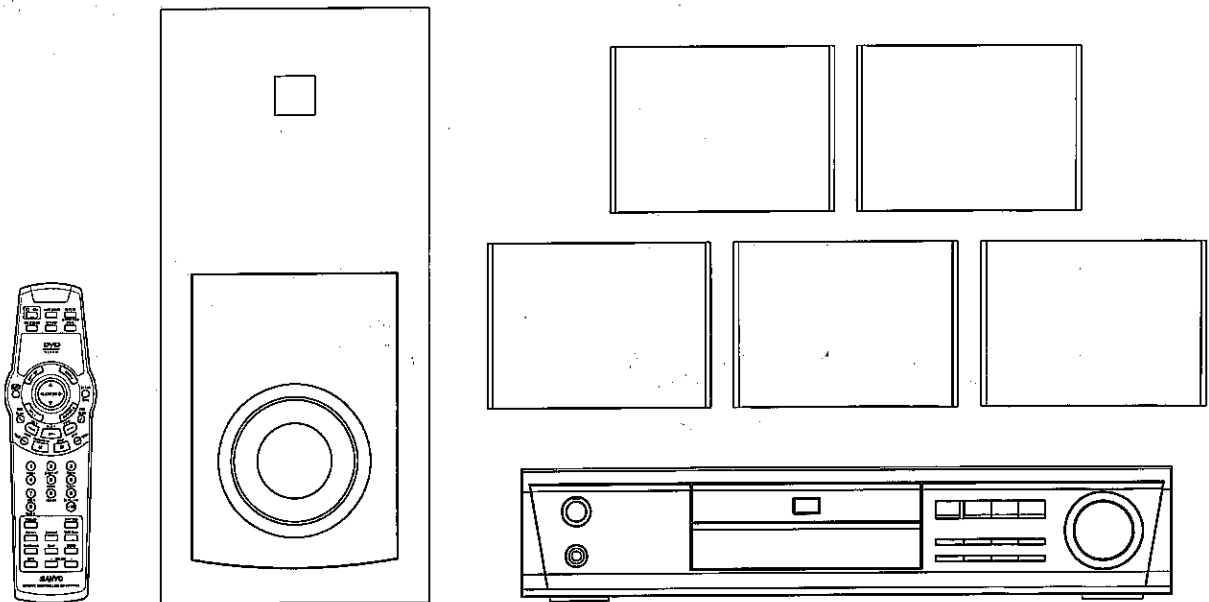

PRECAUTIONS

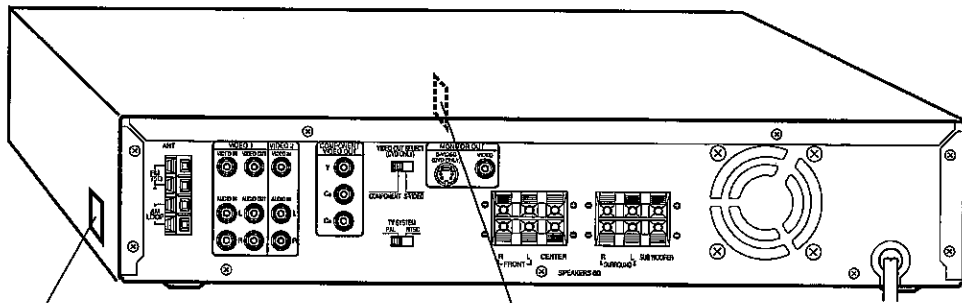

CLASS 1 LASER PRODUCT
LUOKAN 1 LASERLAITE
KLASS 1 LASERAPPARAT

CAUTION - INVISIBLE LASER RADIATION WHEN OPEN AND INTERLOCKS DEFEATED. AVOID EXPOSURE TO BEAM.
 ADVARSEL - USYNLIG LASER STRÅLING VED ÅBNING, NÅR SIKKERHEDSAFBYDERE ER UDE AF FUNKTION, UNDGÅ UDSÆTTELSE FOR STRÅLING.
 VARNING - OSYNLIG LASER STRÅLNING NÅR DENNA DEL ÄR ÖPPNAD OCH SPÄRR ÄR URKOPPLAD. STRÅLEN ÄR FARLIG.
 VORSICHT - UNSICHTBARE LASERSTRAHLUNG TRITT AUS, WENN DECKEL GEÖFFNET UND WENN SICHERHEITVERRIEGELUNG ÜBERBRÜCKT IST. NICHT, DEM STRAHL AUSSETZEN.
 VARO - AVATTAESSA JA SUOJALUKITUS OHITETTAESSA OLET ALTTIINA NÄKYMÄTTÖMÄLLE LASERSÄTEILYLLE. ÄLÄ KATSO SÄTEESEEN.



CAUTION - USE OF CONTROLS OR ADJUSTMENTS OR PERFORMANCE OF PROCEDURES OTHER THAN THOSE SPECIFIED IN THE OPERATING INSTRUCTIONS MAY RESULT IN HAZARDOUS RADIATION EXPOSURE. THIS UNIT SHOULD NOT BE ADJUSTED OR REPAIRED BY ANYONE EXCEPT PROPERLY QUALIFIED PERSONNEL.

- The apparatus shall not be exposed to dripping or splashing.
- Do not use where there are extremes of temperature (below 5°C or exceeding 35°C) or where direct sunlight may strike it.
- Because of the DVD player's extremely low noise and wide dynamic range, there might be a tendency to set the volume on the amplifier unnecessarily high. Doing so may produce an excessively large output from the amplifier which could damage your speakers.
- Sudden changes in the ambient temperature may cause condensation to form on the optical lens inside the unit. If this happens, take out the disc, leave the unit for about 1 hour, and then proceed to operate.
- When carrying the unit, be sure to remove a disc which may be inside and turn the power off. Wait at least 10 seconds, then unplug the mains lead from the AC outlet. Carrying the unit with a disc inside may damage the disc and/or the unit.
- Do not install this equipment in a confined space, such as a book case or built in cabinet.
- Placing the unit in a well ventilated area is strongly recommended. Do not place any object on the top of the unit. Do not block ventilation holes. The cabinet of the unit warms up when it is used for a long time, but it is not a malfunction.

Important Information:
 To connect this unit to a TV, TV must have a Video input socket at least. You cannot connect it to an RF input socket or aerial terminal of TV.
 This product incorporates copyright protection technology that is protected by method claims of certain U.S. patents and other intellectual property rights owned by Macrovision Corporation and other rights owners. Use of this copyright protection technology must be authorized by Macrovision Corporation, and is intended for home and other limited viewing uses only unless otherwise authorized by Macrovision Corporation. Reverse engineering or disassembly is prohibited.

CONTROLS

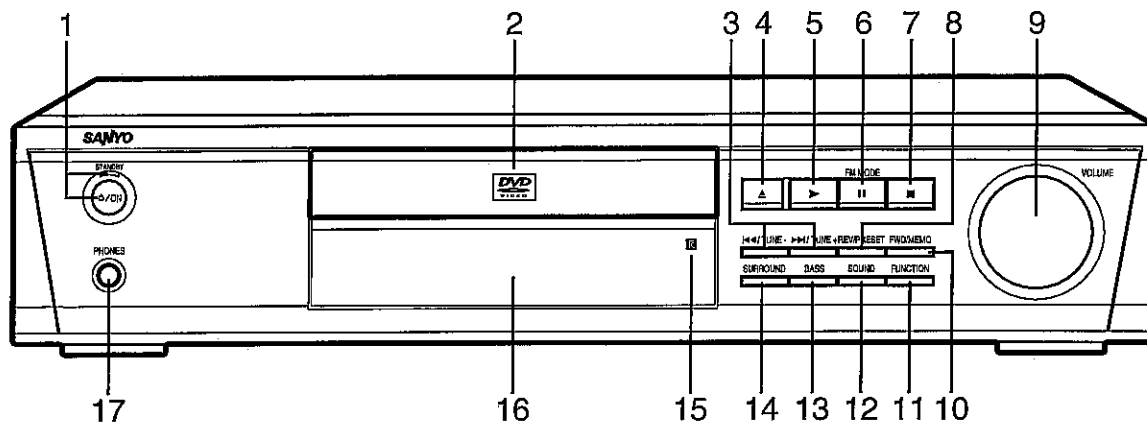

- | | |
|---|--------------------------------------|
| 1. Power button/Standby indicator (⏻/ON, STANDBY) | 10. Forward/Memory button (FWD/MEMO) |
| 2. Disc tray | 11. Function button (FUNCTION) |
| 3. Skip/Next/Previous/Tuning buttons (⏪/TUNE-, ⏩/TUNE+) | 12. Sound preset button (SOUND) |
| 4. Open/Close button (⏏) | 13. Bass button (BASS) |
| 5. Play button (▶) | 14. Surround button (SURROUND) |
| 6. FM mode/Pause/Step button (FM MODE/⏸) | 15. Remote sensor (IR) |
| 7. Stop button (■) | 16. Display |
| 8. Reverse/Preset button (REV/PRESET) | 17. Headphones socket (PHONES) |
| 9. Volume control (VOLUME) | |

REMOTE CONTROL

Note:

In this instruction manual, any operation of pressing any button while pressing the SHIFT button is as shown below.

Example: "Press the **SHIFT + 1 ANGLE** buttons."

Controls

1. Power button (ON/OFF)
2. Number and other function buttons
Number buttons (1 - 9, 0, +10)
Angle button (ANGLE)
Angle replay button (A.REPLAY)
Zoom button (ZOOM)
Audio button (AUDIO)
Sleep button (SLEEP)
Timer button (TIMER)
Adjust button (ADJUST)
Set/Clear button (SET/CLEAR)
Clock button (CLOCK)
3. Amplifier controls
Function button (FUNCTION)
Test tone button (TEST TONE)
Surround button (SURROUND)
Bass button (BASS)
Sound preset button (SOUND)
Muting button (MUTE)
Volume buttons (- VOLUME +)
4. Tuner controls
Tuner function/Band select button (TU/BAND)
Preset tuning button (PRESET)
FM mode button (FM MODE)
5. Shift button (SHIFT)
6. Last memory button (LAST MEMO)
7. Repeat/Search mode button (REPEAT/SEARCH MODE)
8. Programme button (PROG)

9. Return button (RETURN)
10. Menu button (MENU)
11. Clear/Trim button (CLEAR/TRIM)
12. Subtitle button (SUBTITLE)
13. Forward slow button (FWD SLOW)
14. Forward button (FWD)
15. Time setting/Skip/Next/Tuning button (NEXT/TUNE+)
16. Stop button (STOP)
17. Play button (PLAY)

18. Pause/Step button (PAUSE/STEP)
19. Time setting/Skip/Previous/Tuning button (PREV-/TUNE)
20. Reverse button (REV)
21. Reverse slow button (REV SLOW)
22. Title button (TITLE)
23. Joy-stick (ENTER, ▲, ►, ▼, ◀)
24. Setup button (SET UP)
25. On screen button (ON SCREEN)

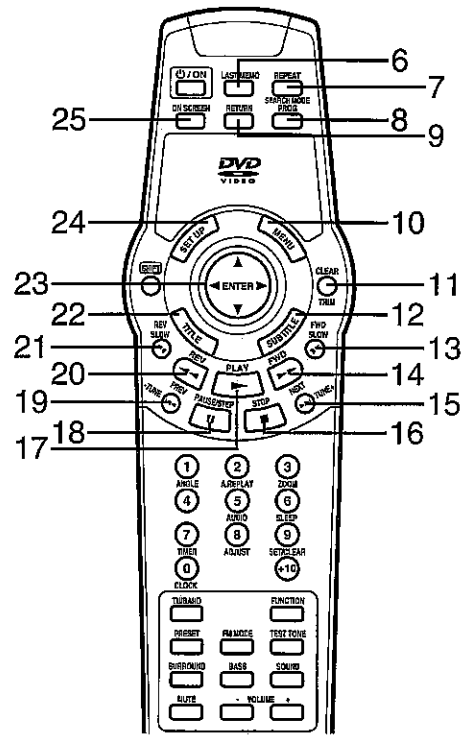
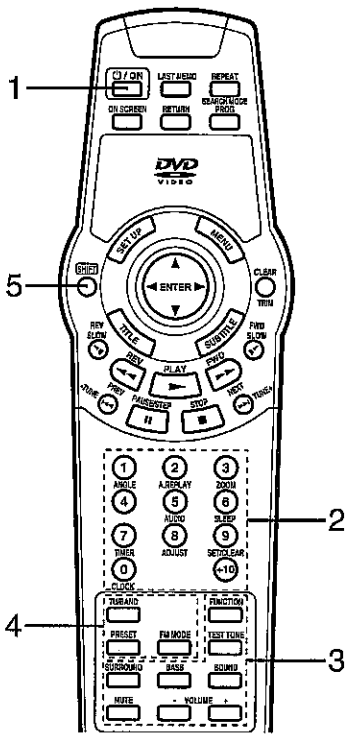

Inserting batteries

Install two "R6/AA" batteries (not supplied).

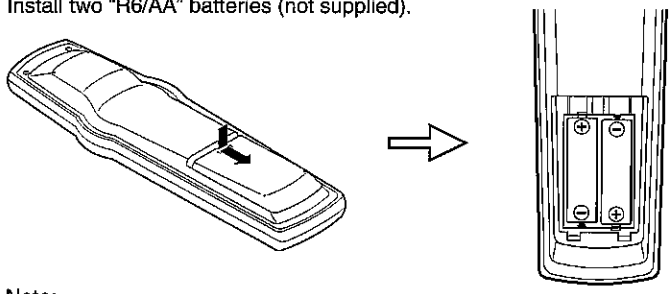

Note:
Remove the batteries if the remote control is not to be used for a month or more. Batteries left in the unit may leak and cause damage.

Remote control range

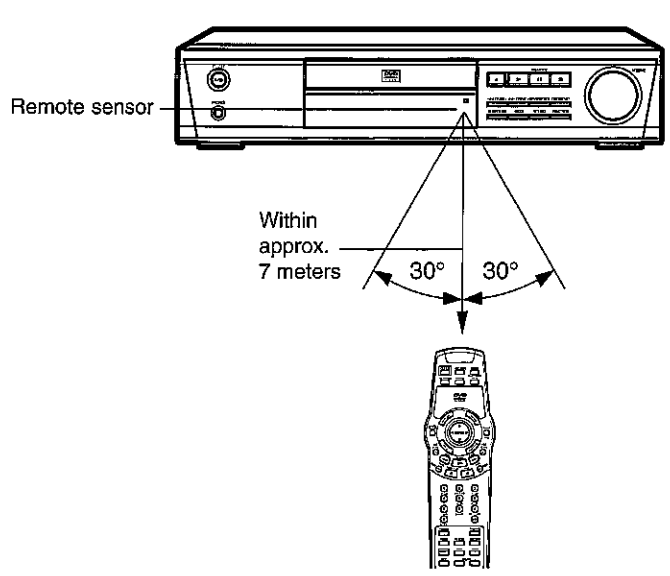

Notes on using the joy-stick

The joy-stick has five functions depending on the direction it is moved.

- Press straight down: ENTER
- Tilt towards the front: ▲
- Tilt towards the right: ►
- Tilt towards the back: ▼
- Tilt towards the left: ◀



Note: Control the stick using your thumb.

BASIC CONNECTIONS

Selecting TV system

Before connecting, be sure the TV SYSTEM switch (rear of the unit) setting corresponds with your local TV system (PAL or NTSC).

After all connections have been made, connect the mains lead to an AC outlet.

Note:

- Do not connect the mains lead to an AC outlet until all connections have been made.
- The system is not completely disconnected from the mains when the ϕ /ON button is set to the ϕ position.

Speaker connections

To achieve proper stereo reproduction, connect the speaker wires without shorting to adjacent wires as shown in figure.

Speaker wire colour	Use
Black and Red	Front right speaker
Black and Blue	Front left speaker
Black and Green	Centre speaker
Black and Orange	Surround right speaker
Black and Gray	Surround left speaker
Black and Brown	Subwoofer

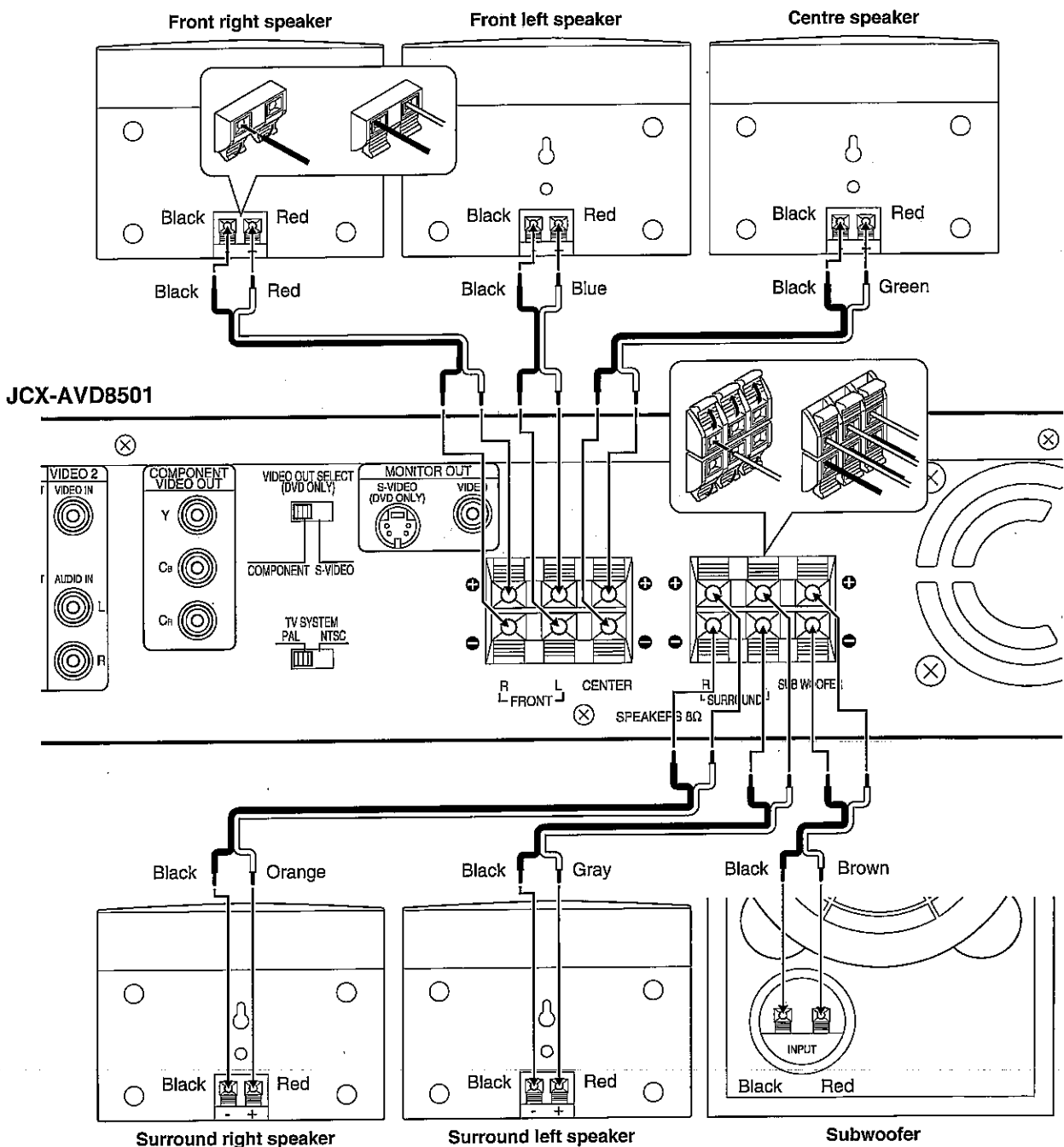

Speaker placement

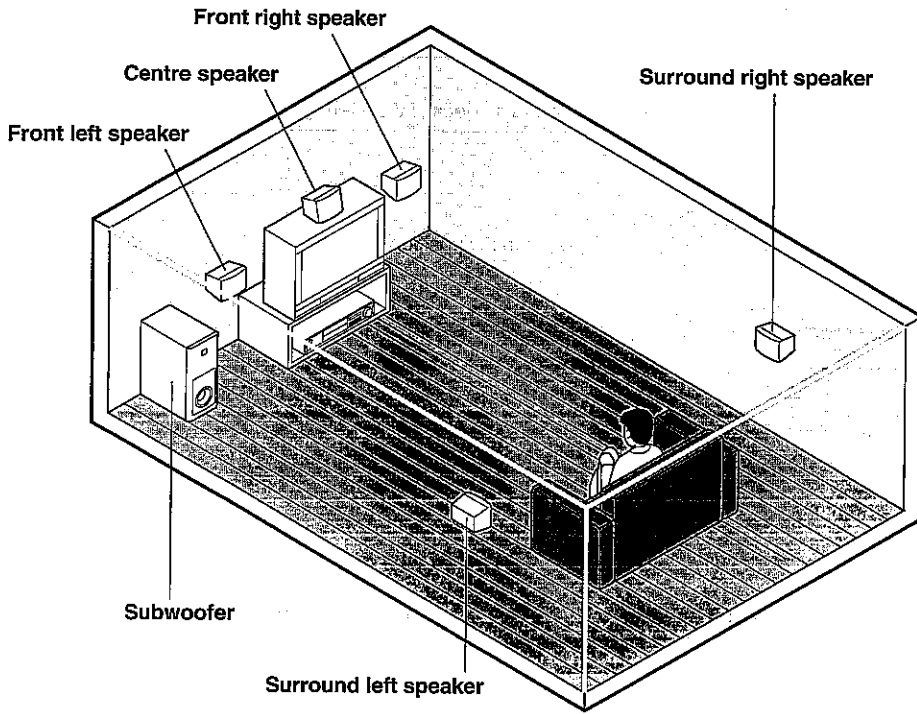

The supplied speaker has built-in magnetic stray field compensation. It may be placed close to a TV without affecting the colour purity.

Five speakers are all the same and can be used for Front left, Centre, Front right, Surround left and Surround right speakers.

Note:

If you use the other speaker system, please refer to "Speaker" under "INITIAL SETTINGS". (See Page 16.)

Example: To hang the speaker on a wall

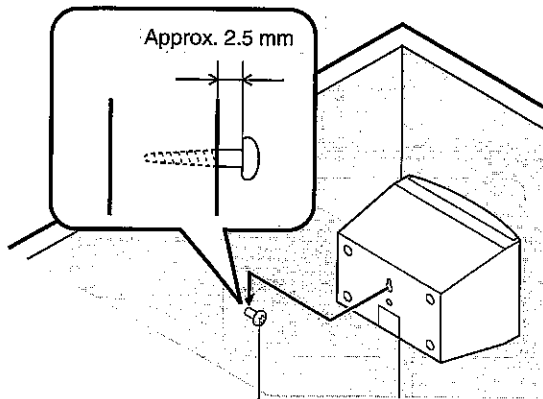

Round head screw (not supplied)

Example: To mount the speaker with a stand

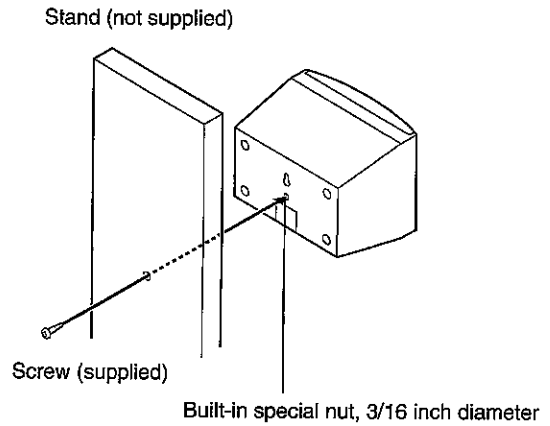

Note: Be careful of falling the speaker system, it might cause the damage or serious injuries.

Aerial connections

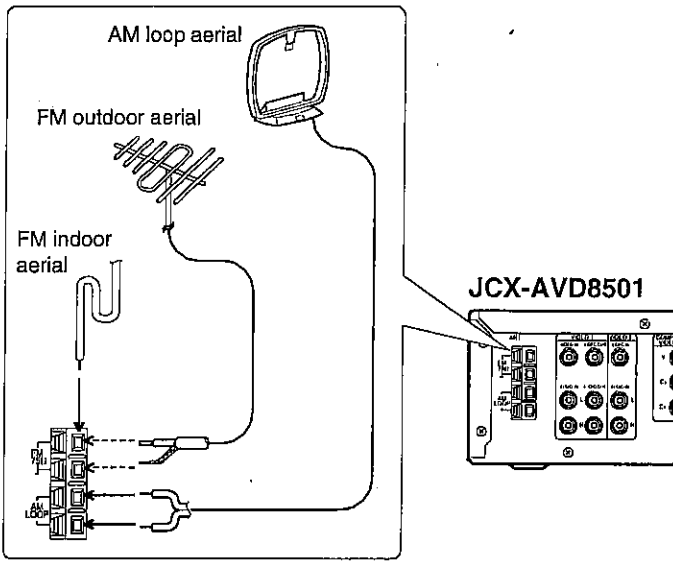

FM aerial

The FM indoor aerial is sufficient to receive most local FM broadcasts and should be connected to the FM 75Ω terminal. Extend the aerial wire as straight as possible and, while listening to the sound from the system, secure it in a position which yields minimal distortion and noise. In fringe areas or where reception is distorted or noisy, an FM outdoor aerial (not supplied) should be connected instead of the indoor aerial. The terminals will accept 75-ohm coaxial cable. Consult your dealer.

AM loop aerial

Assemble the loop aerial.

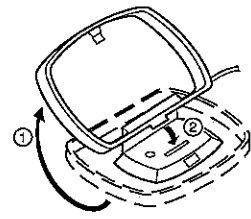

Unwind the aerial wires, then connect them to the AM LOOP terminals. Place the loop aerial in a position which yields the best AM reception, or attach it to a wall or other surface.

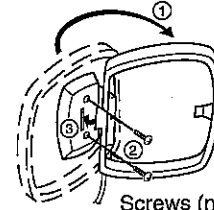

Screws (not supplied)

Note:

To minimize noise, the speaker, mains and any other leads should not come close to the FM indoor or outdoor aerial lead and AM loop aerial. Do not place the aerial leads close to the system.

Connecting to a TV with the video lead

Connect the video lead between the MONITOR OUT VIDEO socket of the unit and the video input socket of the TV.

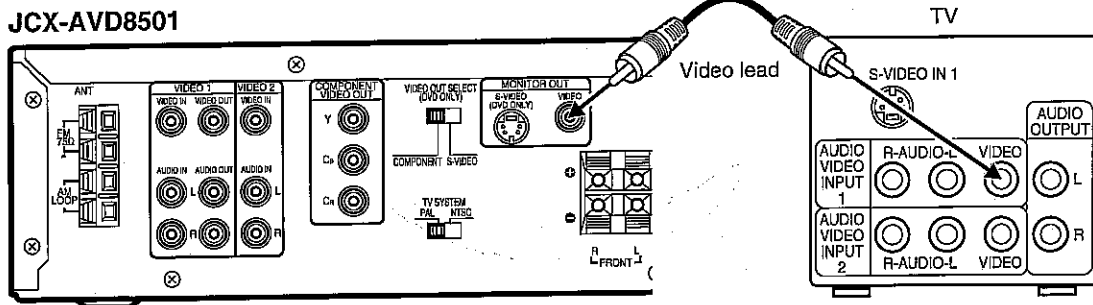

Notes on connections

- Please refer to the instruction manuals for the components that you are connecting (TV, VCR, etc.).
- When you connect the unit to your TV and other equipment, be sure to turn off the power and disconnect all of the equipments from the AC outlet until all the connections have been made.
- **Do not connect the MONITOR OUT (S-VIDEO/VIDEO) and COMPONENT VIDEO OUT sockets of the unit to a VCR directly. The playback picture will be distorted because DVD discs are copy protected.**
- Please consult your local audio/video dealer for more details.

ADDITIONAL CONNECTIONS EXAMPLES

Connecting to a TV with an S-video lead

Please follow the steps before turn on the power.

1. If your TV has an S-video input socket, connect the unit as shown in figure. (The MONITOR OUT VIDEO socket connection is not necessary.) You can enjoy clearer picture playback.
2. Set the VIDEO OUT SELECT switch to S-VIDEO.

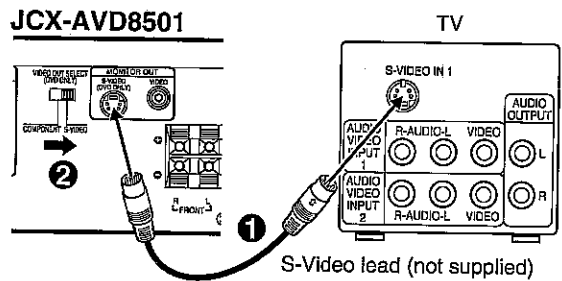

Connecting to a TV with a component video lead

Please follow the steps before turn on the power.

1. If your TV has component video input sockets, connect the unit as shown in figure. (The MONITOR OUT S-VIDEO/VIDEO socket connection is not necessary.) You can enjoy high quality picture playback.
2. Set the VIDEO OUT SELECT switch to COMPONENT.

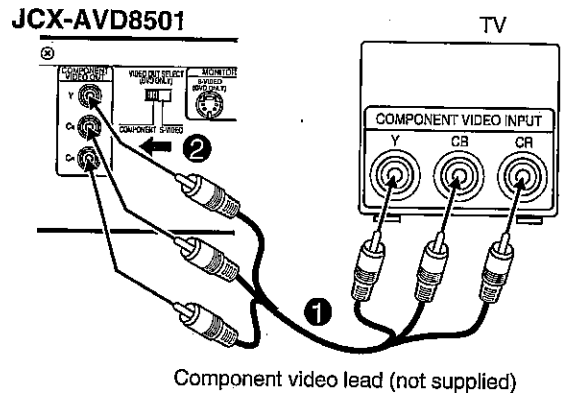

VCR Connections

With this connection, it is possible watch and listen to videocassettes or other video equipment.

Connect the 1st VCR as shown in figure (1) - (4).

If using 2nd VCR or other video equipment, connect it as shown in figure (5) - (6).

Video leads (not supplied)

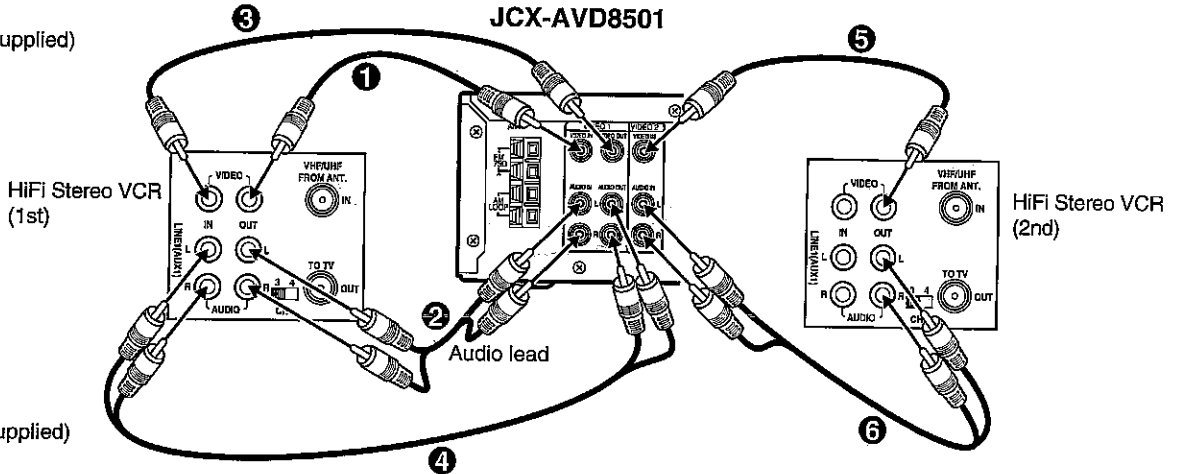

Note:

- The picture from VCR may be distorted in some cases.
- When watching VCR, you must connect the video lead between the MONITOR OUT VIDEO socket of the unit and the video input socket of the TV. There are no VCR video signals from MONITOR OUT S-VIDEO and COMPONENT VIDEO OUT sockets of the unit.

Headphones

Connect stereo headphones (not supplied) to the PHONES socket for monitoring or for private listening. The speakers are automatically disconnected when headphones are connected.

Manufactured under license from Dolby Laboratories.

"Dolby", "Pro Logic" and the double-D symbol are trademarks of Dolby Laboratories.

DVD disc with DTS may not work correctly. You can see the picture on the TV screen, but there is no sound.

"DTS" and "DTS Digital Out" are trademarks of Digital Theater Systems, Inc.

BEFORE OPERATION

Turning the power on and off

Press the \odot /ON button. The STANDBY indicator goes out. (After connecting the mains lead, when you press the \odot /ON button for the first time, the volume-reset feature automatically sets the initial volume level.) To turn the power off, press the \odot /ON button again. The STANDBY indicator lights.

- When the mains lead is connected to the AC outlet, the unit will respond to commands from the remote control.

Direct start function

If the following buttons are pressed when the unit is in standby, the unit turns on automatically and the selected function is activated.

Main unit ▶, ▲
Remote control PLAY, TU/BAND

Selecting the function

Press the FUNCTION button to select the desired function. Each time the button is pressed, the display changes as follows:

DVD → VIDEO 1 → VIDEO 2 → FM → AM → ...

- When the function selection is changed, disc play is automatically stopped.

Adjusting the volume

Turn the VOLUME control (or press the + or - VOLUME button on the remote control). The volume level appears on the display (VOL. 0 ~ VOL. 80).

To reduce the volume temporarily (Remote control only)

Press the MUTE button. The volume control illumination blinks. To restore the previous volume setting, press the MUTE button again.

Bass boost system

Press the BASS button to select the desired bass boost effect.

BASS OFF → BASS ON1 → BASS ON2 → BASS OFF ...

Selecting the sound mode

Press the SOUND button to select the sound mode matching the source to be listened to.

POP: Pops, etc.
CLASSIC: Classical music, etc.
ROCK: Rock music, etc.
JAZZ: Jazz, etc.

WHAT TO DO IF...

If the operation of the unit or display is not normal,

1. Disconnect the mains lead.
2. While pressing both BASS and SOUND buttons on the main unit at the same time, connect the mains lead. "RESET" briefly appears on the display.
3. Resume operation.

ADJUSTING THE CLOCK (Using the remote control)

Example: To set "PM 6:30"

1. Press the \odot /ON button to turn the power on.
2. Press the SHIFT + 0 CLOCK buttons. "AM 12:00" blinks.
3. Press the SHIFT + 8 ADJUST buttons.

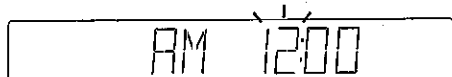

The hours display blinks.

4. Press the ▶▶| or |◀◀ button to set the "hours".

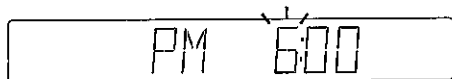

5. Press the SHIFT + 8 ADJUST buttons.

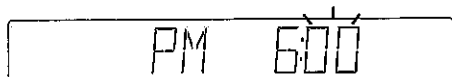

The minutes display blinks.

6. Press the ▶▶| or |◀◀ button to set the "minutes".

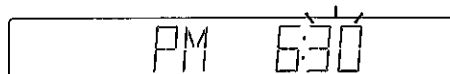

7. Press the SHIFT + 8 ADJUST buttons. The clock starts.

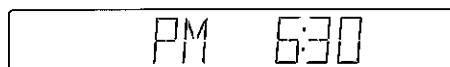

- The time can be set accurately by pressing the SHIFT + 8 ADJUST buttons when a time signal is heard.

To display the clock during operation

Press the SHIFT + 0 CLOCK buttons. Press both buttons again to return to the original display.

Note:

When the display blinks because of a power failure, reset the time.

SELECTING THE SURROUND MODE

Press the SURROUND button to select the surround mode. Each time the button is pressed, the surround mode changes as follows:

PROLOGIC → 3-CH → THEATER → HALL → SURR OFF → PROLOGIC . . .

Note:
Some discs may restrict the selection.

PROLOGIC: Dolby Pro Logic mode

When playing a programme source encoded with Dolby Surround sound (video tape, laser disc, DVD, etc.) (Fig. A)

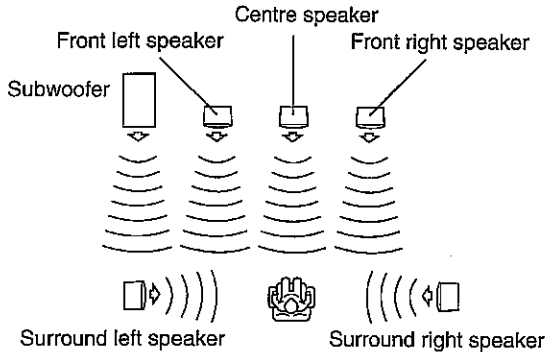

Fig. A

3-CH: 3 channel mode

Using only the Front left, Centre, Front right and Subwoofer speakers (Fig. B)

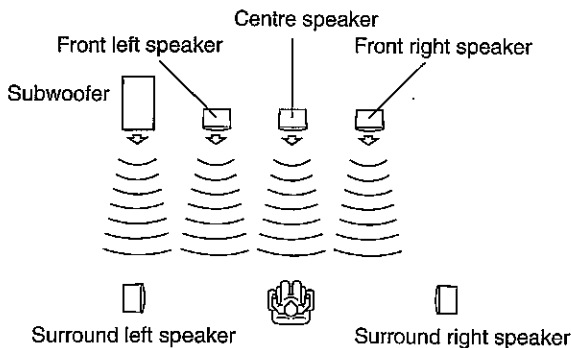

Fig. B

THEATER: "Theater" effect

HALL: "Hall" effect

When playing a programme source which is not encoded with Dolby Surround sound (Fig. A)

SURR OFF: Normal stereo sound

Using only the Front left, Front right and Subwoofer speakers (Fig. C)

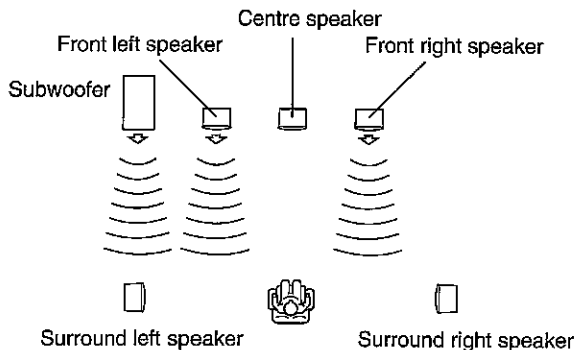

Fig. C

DOLBY D: Dolby Digital 5.1 Channel mode

When playing a DVD disc encoded with Dolby Digital 5.1 Channel (Fig. A)

Note:

Centre or Surround speakers do not sound with some discs.

Selecting Dolby Pro Logic Surround mode

When playing a programme source encoded with Dolby Surround sound (video tape, laser disc, DVD etc.), follow the steps below.

Please use the remote control at the listening point.

1. Press the + or - VOLUME button to adjust the sound level from the speakers.
2. Press the SURROUND button repeatedly until "PROLOGIC" appears.
3. Press the TEST TONE button. "TTONE" appears and "FL" blinks. The test tone will be heard from each speaker sequentially as follows:

TTONE

FL (Front left speaker)
C (Centre speaker)
FR (Front right speaker)
RS (Surround right speaker)
LS (Surround left speaker)

4. Press the + or - VOLUME button until the test tone is at a comfortable level.

If the test tone level is not the same from each speaker, you may need fine adjustment of the volume level. Please follow the steps as below.

Note:

If leave it, the original display returns after approximately 15 seconds.

- 1) Press the TEST TONE button to turn the test tone off.
- 2) Press the SURROUND button to select the desired surround mode.
- 3) Press the SHIFT + TRIM buttons. "FNTL 0" appears.
- 4) Press the ENTER button repeatedly to select the speaker.

FL display (Speaker)

FNTL (Front left speaker)
CENT (Centre speaker)
FNTR (Front right speaker)
SURR (Surround right speaker)
SURL (Surround left speaker)
SUBW (Subwoofer)

- 5) Press the ► or ◀ button to adjust the volume level. (FNTR/FNTR: "0" - "-10", CENT/SURR/SURL/SUBW: "+10" - "-10".)
- 6) Press the ENTER button.
- 7) Repeat step 4) to 6) for another speaker, if necessary.
- 8) Press the SHIFT + TRIM buttons again to turn it off.

5. Press the TEST TONE button to turn the test tone off. "TTONE" disappears.





6. Press the + or - VOLUME button to adjust the volume.

Notes:

- There is no Dolby Surround effect when monaural programme material is used.
- When receiving weak FM broadcasts, switch the Dolby Pro Logic off. The sound quality may improve.
- When headphones are connected while any of the surround modes are selected, the surround mode is switched off automatically. The SURROUND button does not function while headphones are connected.
- For other surround mode, please refer to "Selecting Dolby Pro Logic Surround mode" as above.
- Trimming can be set at each function respectively.

PLAYABLE DISCS

The following types of discs can be played on this unit.

Disc type and logo mark		Recorded content	Disc size	Maximum playing time
DVD Video		Audio + Video	12 cm	Approx. 4 hours (Single sided disc) Approx. 8 hours (Double sided disc)
			8 cm	Approx. 80 minutes (Single sided disc) Approx. 160 minutes (Double sided disc)
Video CD	 	Audio + Video	12 cm	74 minutes
			8 cm	20 minutes
Music CD		Audio	12 cm	74 minutes
			8 cm	20 minutes

Region number

Region number (Regional restriction code) is built-in to the unit and DVD discs.

There is a region number on the rear of the unit.

The same region number or region number "ALL" of DVD discs can be used on this unit.

DVD disc

There are the marks on some DVD disc package.

Examples:

 Multiple Languages

 Multi-language subtitles

 Multi-Angle

 Multi-Aspect

 Region number

DVD discs are divided into titles, and the titles are sub-divided into chapters.

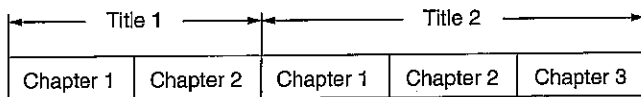

Video CD/Music CD disc

Video CD and Music CD discs are divided into tracks.

Track 1	Track 2	Track 3	Track 4	Track 5
---------	---------	---------	---------	---------

Note:

- Only the above types of discs can be played on this unit. DVD-ROM, CD-ROM, SVCD, CVD, etc. cannot be played.
- This unit can play back the CD-R/RW that have recorded music data or MP3 files as well. However, some CD-R/RWs can not be played back depending on the recording conditions.
- The CD-R/RW that has no music data or non-MP3 files can not be played back.
- This unit is to be used exclusively with the PAL or NTSC colour system. SECAM system discs cannot be used with this unit.

Notes on handling discs

- Do not expose the disc to direct sunlight, high humidity or high temperatures for extended periods of time.
- Discs should be returned to their cases after use.
- Do not apply paper or write anything on the disc surface.
- Handle the disc by its edge. Do not touch the playing surface (glossy side).
- Fingerprints and dust should be carefully wiped off the playing surface of the disc with a soft cloth. Wipe in a straight motion from the centre to the outside of the disc.
- Never use chemicals such as record cleaning sprays, antistatic sprays or fluids, benzene or thinner to clean discs.

DISC PLAY

Important note:

- This "DISC PLAY" explains the basic instruction of the DVD player section using the remote control unit.
- Some DVD or Video CD discs have different functions that may not be explained in this instruction manual. You may be needed extra instructions. In this case, please follow the instructions displayed on the TV screen or jacket or case of the disc.
- "⊘" may appear on the TV screen during operation. This icon means that the function is not available on the disc now.

Preparations

- Turn on the TV and select the channel for the DVD player.
- Select the playback picture size according to the aspect ratio of the TV. (See "Display" under "INITIAL SETTINGS" on Page 16.)

Note:

- Do not touch the disc tray while it is moving.
- Never place anything except a disc on the disc tray. Foreign objects can damage the unit.
- Do not apply excessive force to the disc tray.
- Discs must be placed on the disc tray one at a time.
- To open or close the disc tray, be sure to use the ▲ button (Main unit). Do not press the disc tray with your hand.

When operation buttons are pressed, that operation is displayed on the TV screen. The display turns off after several seconds.

If a disc is loaded, you can turn the unit on and begin play immediately by pressing the PLAY button.

1. Press the ▲ button. "OPEN" appears on the display and the disc tray opens. "SANYO" logo appears on the TV screen.
2. Place the disc with the label facing up on the disc tray.

12 cm disc

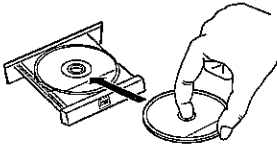

8 cm disc

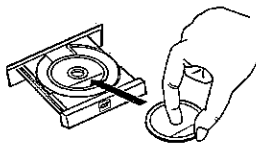

3. Press the ▲ button again to close the disc tray.
 - Some discs may start play automatically.

Starting play

Press the PLAY button. The DVD function is selected and play starts automatically.

- When using the main unit, use the ► button.

Example:

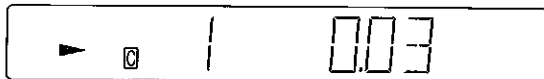

Note:

If "NO DISC" appears on the display, load the disc.

- If the disc is loaded with the label side downward (and it is a single sided disc), or if a badly scratched disc is loaded, "NO DISC" (or "NO PLAY") appears. If this occurs, load the disc correctly or replace the disc.

If a menu appears on the TV screen...

Press the ▲, ►, ▼ or ◀ button (or the number buttons), then press the ENTER button to select the desired menu. Playback of the selected menu will start.

Note:

For more details, please refer to the jacket or case of the disc.



Stopping play

- Press the STOP button once.
 - When you press the PLAY button, play starts automatically from the point where you stopped.
 - When using the main unit, use the ■ button.

Note:

Some discs may not resume play.

- Press the STOP button twice. The player stops completely.
 - When you press the PLAY button, play starts from the beginning of the disc.

Continuing play from where you stopped watching (LAST MEMORY PLAY) [DVD]

1. During play, press the LAST MEMO button at the point from which you want to resume play later. "L.M.-STOP" appears on the display. Play stops automatically.
2. Remove the disc or turn off the power.
3. Load the disc (and press the PLAY button), or turn on the power. "Last Memory Play?" screen appears.

Last Memory Play?

Yes

No

Clear ... The memory is released.

4. Press the ▲ or ▼ button to select "Yes".
5. Press the ENTER button. Play resumes from the point where you stopped. (If desired, press the LAST MEMO button again.)

Note:

- Point on up to 5 discs can be memorized.
- The Last Memory Play mode may not work correctly with some discs.

What is "PBC"?

"PBC" is an abbreviation for "Playback Control" that refers to control codes prerecorded on Video CDs.

During playback of Video CD with PBC, "PBC" appears on the display.

To lock the disc tray (Using the main unit)

You can lock the disc tray to prevent misuse of young children.

While the disc tray is opened, press the ▲ button until "LOCKED" appears on the screen.

- The ▲ button will not function.

To release this mode, press the ▲ button until "UNLOCKED" appears.

VARIOUS DISC PLAYING FUNCTIONS

"⊘" may appear on the TV screen during operation. This icon means that the function is not available on the disc now.

Selecting a DVD menu [DVD]

1. Press the MENU button. The main menu screen appears.
Note:
Press the MENU button again to resume play.
2. Press the ▲, ►, ▼ or ◀ button (or the number buttons) to select the desired menu then press the ENTER button. The selected menu play starts.

Selecting a title menu [DVD]

1. Press the TITLE button. The title menu appears.
Note:
Press the TITLE button again to resume play from the scene when the TITLE button was first pressed.
2. Press the ▲, ►, ▼ or ◀ button (or the number buttons) to select the desired title then press the ENTER button. The selected title play starts.

Note:

Selecting a DVD or title menu operation may differ depending on the disc used and may not be possible on some discs.

Return button (RETURN) for Video CD

Normally, it returns to the previous menu when the RETURN button is pressed during play.

Note:

The operation differs according to the content of the Video CD.

Chapter (Track) skip

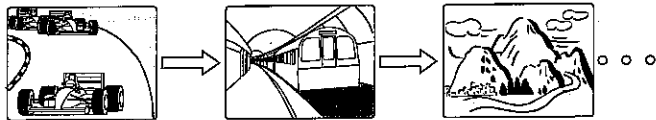

Skipping forward

Press the NEXT button during play to skip to the next chapter (or track). A chapter (or track) is skipped each time the button is pressed.

- When using the main unit, use the ►►/TUNE+ button.

Skipping back

Press the PREV button during play to skip back to the beginning of the chapter (or track) currently play. Press the button again immediately to skip back to the beginning of the previous chapter (or track).

- When using the main unit, use the ◀◀/TUNE- button.

Note:

You can skip only through the chapters, not over the title on the DVD disc.

Title search [DVD]

1. Press the SHIFT + SEARCH MODE buttons once during play or in the stop mode. "TITLE SEARCH..." screen appears.
2. Press the number button(s) to enter the title number. Play starts from the selected title.

Example:

To select No. 3, press 3.

To select No. 10, press +10, then 0.

To select No. 24, press +10, +10, then 4.

Chapter search [DVD]

1. Press the SHIFT + SEARCH MODE buttons twice during play. "CHAPTER SEARCH..." screen appears.
2. Press the number button(s) to enter the chapter number. Play starts from the selected chapter.

Track search [Video CD] [CD]

Press the number button(s) during play or in the stop mode. Play starts from the selected track.

Time search

[DVD]

1. Press the SHIFT + SEARCH MODE buttons three times during play. "TIME SEARCH..." screen appears.
2. Press the number button(s) to enter the time.

Example:

20 minutes 5 seconds

Press 2, 0, 0 then 5.

1 hour 4 minutes 35 seconds

Press 1, 0, 4, 3 then 5.

Note:

- Do not use the +10 button.

- If you made a mistake, press the CLEAR button.

3. Press the PLAY button. Play starts from the searched time.

[Video CD] [CD]

1. Press the SHIFT + SEARCH MODE buttons once during play. "TIME SEARCH..." screen appears.
2. Press the number button(s) to enter the time.
3. Press the PLAY button. Play starts from the searched time in the track.

Note:

By repeating steps 1 - 3 in the stop mode, play starts at the searched time in the disc.

Fast play

Press the FWD or REV button repeatedly to select the fast speed forward or reverse play.

[DVD] [Video CD]

"FF1 ►►", "FF2 ►►", "FF3 ►►" or "FR1 ◀◀", "FR2 ◀◀", "FR3 ◀◀"

[CD]

"FF1 ►►", "FF2 ►►" or "FR1 ◀◀", "FR2 ◀◀"

Press the PLAY button to return to normal play.

Slow-motion play

[DVD] [Video CD]: Forward slow play, [DVD]: Reverse slow play
Press the FWD SLOW or REV SLOW button repeatedly to select the forward or reverse slow speed play.

"SF1 ►►", "SF2 ►►", "SF3 ►►" or "SR1 ◀◀", "SR2 ◀◀", "SR3 ◀◀"

Press the PLAY button to return to normal play.

Note:

The sound is muted during fast play or slow-motion play in DVD and Video CD.

Still picture (Pause)

[DVD] [Video CD]: Still picture mode, [CD]: Pause mode

Press the PAUSE/STEP button during play.

- When using the main unit, use the || button.

Press the PLAY button to resume normal play.

Note: The sound is muted.

Frame by frame advance play [DVD] [Video CD]

Press the PAUSE/STEP button during still picture. Each time the button is pressed, the picture advances one frame.

Press the PLAY button to resume normal play.

Note:

- The sound is muted.

- Frame play is operated forward only.

Picture zoom [DVD] [Video CD]

1. Press the SHIFT + 3 ZOOM buttons during play. The central part of the picture is magnified.

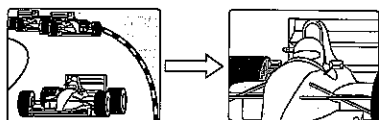

- Each time you press the SHIFT + 3 ZOOM buttons or press the RETURN button, the picture zooms in or out ("Zoom +15" - "Zoom -15").
- Each time you press the ▲, ►, ▼ or ◀ button, the picture moves from side to side, up and down.

2. To return to normal play, press the CLEAR button.

Note:

Some discs may not work Picture zoom.

Viewing from a desired camera angle (Multi-Angle) [DVD]

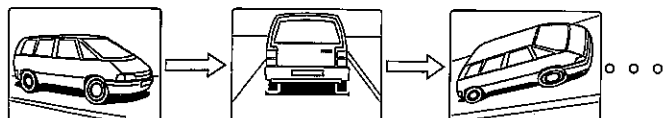

Some DVD discs may contain scenes which have been shot simultaneously from a number of different camera angles. The jacket or case of discs that are recorded with angles will be marked.

Example:



Note: The recorded angles differ depending on the disc used.

1. Play the disc that is recorded with angles.
2. Press the SHIFT + 1 ANGLE buttons repeatedly until the desired angle appears.

Example:



Angle replay [DVD]

During Multi-angle play screen, press the SHIFT + 2 A.REPLAY buttons. The player skips back to last approximately 10 seconds, changes it to the next camera angle and plays it, and continues play. (If desired, press both buttons again.)

Repeat play

Press the REPEAT button during play (or programmed play) of the title (or track) you want to repeat. Each time the button is pressed, the repeat mode changes as follows.

[DVD]

- ↪ Title (1 REP.): Repeat of title being played
- ↪ Off: Normal play mode

[Video CD] [CD]

- ↪ 1 (1 REP.): Repeat of track being played
- ↪ All (ALL REP.): Repeat all tracks
- ↪ Off: Normal play mode

Note:

Repeat play mode may not work correctly with some discs.

Programmed play [Video CD] [CD]

Up to 32 selections can be programmed.

Programming procedure

1. Press the PROG button in the stop mode. "PROGRAM" screen appears. "PROG." blinks and "Pr 1" appears on the display.
2. Press the number button(s) to select the track number.

Example:

To select track No. 3, press 3.

To select track No.10, press 1, then 0.

To select track No.24, press 2, then 4.

Note:

- If you made a mistake, press the CLEAR button.
 - Do not use the +10 button.
 - Press the PROG button to quit this menu.
3. Press the ENTER button. The highlighted box automatically moves to the next programme number.

Example:

PROGRAM

#	Track	Track Time
1	02	00 : 04 : 57
--	--	--
--	--	--
--	--	--
--	--	--
--	--	--
--	--	--

00 : 04 : 57

Total programmed time

4. Repeat step 2 - 3 above to select another track.
5. Press the PLAY button to start play. "PROG." remains lit. When all programmed selections have played, the player stops automatically.
 - The programme contents are retained in memory.

To clear the programme one by one

In the programming mode, press the ▲ or ▼ button to select the programme number. Then press the CLEAR button.

To clear all the programmes

In the programming mode, press the STOP button.

To change the programme

1. In the programming mode, press the ▲ or ▼ button to select the programme number.
2. Press the number button(s) to select the track number to be replaced, then press the ENTER button.

To use the programme again with the same contents

Press the PROG button. The previous programme contents appears on the screen, then press the PLAY button.

Selecting subtitle language [DVD]

This operation works only with discs on which multiple subtitle languages are recorded.

1. Press the SUBTITLE button during play. "SUBTITLE CHANGE" screen appears.
2. Press the ▲ button to select "On". The language is highlighted.

Example:

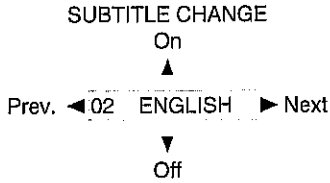

3. Press the ► or ◀ button to select the desired subtitle language, then press the SUBTITLE button.

Note:

- In some cases, the subtitle language is not changed to the selected one.
- When a disc supporting the closed caption is played, the subtitle and the closed caption may overlap each other on the TV screen. In this case, turn the subtitle off.
- When the desired language is not selected even if the button is pressed, the language is not available on the disc.
- When the power is turned on or the disc is replaced, select the subtitle language again.
- If the subtitle language is not necessary, select "Off".

Selecting audio soundtrack language (Multi-Language) [DVD]

This operation works only with discs on which multiple audio soundtrack languages are recorded.

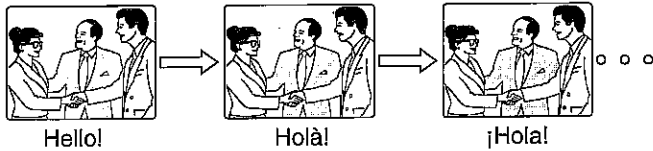

1. Press the SHIFT + 5 AUDIO buttons during play.
2. Press the SHIFT + 5 AUDIO buttons repeatedly until the desired language appears on the screen.

Example:

AUDIO CHANGE 04 FRENCH

Note:

- When the desired language is not selected even if the button is pressed, the language is not available on the disc.
- When the power is turned on or the disc is replaced, select the language again.
- If the language is not recorded on the disc, only the available language on the disc will be heard.

Changing the audio channel output [Video CD]

During Video CD play, press the SHIFT + 5 AUDIO buttons to select an audio channel.

LEFT MONO → RIGHT MONO → STEREO → LEFT MONO ...

Selecting on-screen information

Press the ON SCREEN button repeatedly to show the disc information (Title, Chapter, Title elapsed playing time, Language, etc.).

Example for DVD:

1. Press the ON SCREEN button.

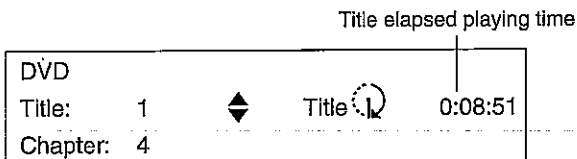

By pressing the ▲ or ▼ button, the title or chapter information changes.

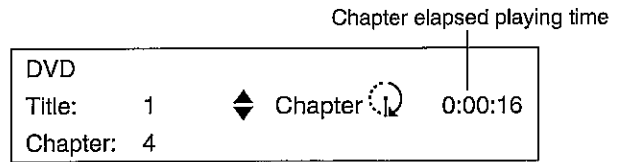

2. Press the ON SCREEN button.

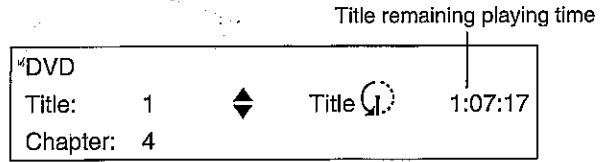

By pressing the ▲ or ▼ button, the title or chapter information changes.

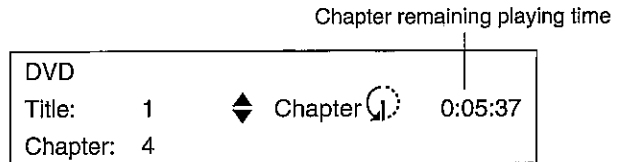

3. Press the ON SCREEN button.

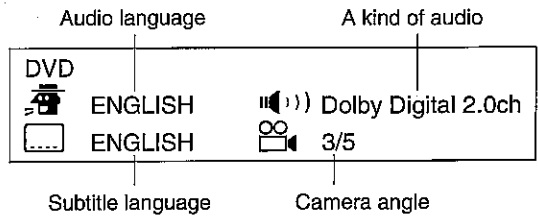

Note:

The ▲ or ▼ button can be used only on the active screen while "ON SCREEN" is working.

Example for VCD:

1. Press the ON SCREEN button.

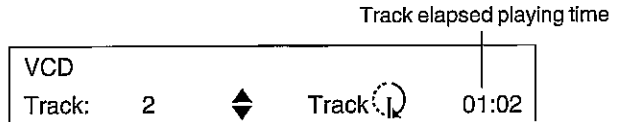

By pressing the ▲ or ▼ button, the track or disc information changes.



2. Press the ON SCREEN button.

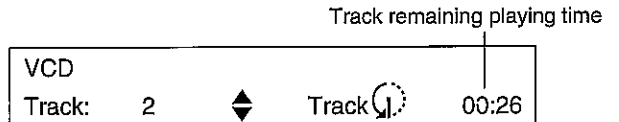

By pressing the ▲ or ▼ button, the track or disc information changes.

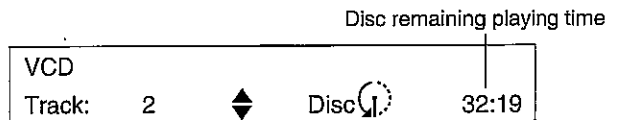

Note:

For Music CD, please refer to "Example for VCD" as above.

MP3 CD OPERATION

This player can play back the CD-R/RW that have recorded music data or MP3 files. Before playing back MP3 CD, please read the following.

MP3 CD information

Limitations on MP3 CD play

- This player can recognize up to 255 files or folders per disc. The CD with 256 files or folders and over is not available to this player.
- This player can recognize up to 8 directory trees per disc.
- MP3 CD may not be played in the recorded order.
- As for multi-session disc, only the first session can be played.
- If the CD has both audio tracks and MP3 files, only audio tracks are played.
- It would take 30 seconds or more for this player to read MP3 files depending on its structure.

Limitations on display

- The maximum number for display is 33 letters. Available letters for display are the following: capital or small alphabets of A through Z, numbers of 0 through 9, and _ (underline).
- Other letters than those above are replaced in blank.

Notes on MP3 files

- The recommend recording setting for a high-quality sound is 44.1 kHz of sampling frequency and 128kbps of fixing bit rate.
- To play MP3 CD in the recorded order,
 1. Please use the MP3 software with the function that can record data alphabetically or numerically.
 2. Put the name including two-digit or three-digit number like "01" "02" or "001" "002" on each file.
 3. Please refrain from making many sub-folders by preference.
- Some MP3 CDs can not be played back depending on the recording conditions.

MP3 CD Play

1. Load the MP3 CD.

A table of contents in the root directory appears on the TV screen.

Example: (the root directory)

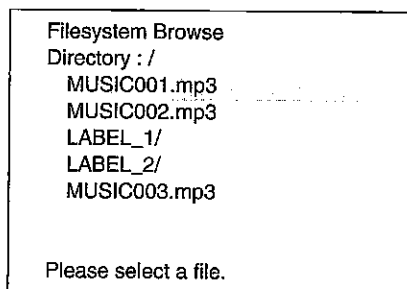

Note:

If nothing appears on the TV screen, press the MENU button.

2. Select the desired file by pressing the ▲ or ▼ button. The selected file is highlighted.
 - To go on to the next directory, select the appropriate folder and press the ► button. A table of contents in the selected directory appears on the TV screen.
 - To go back to the previous directory, press the ◀ button.
 - You can go on up to the eighth directory.
3. Press the ENTER (or PLAY) button to start playback. Elapsed playing time and total playing time in current file are displayed on the TV screen.

Example: (the second directory)

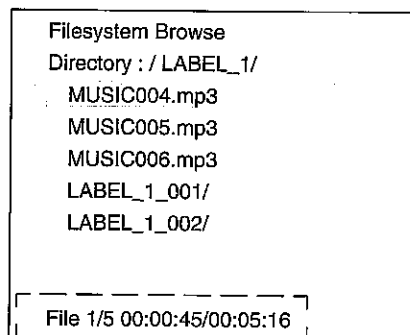

File information

Notes on file skip

Skipping forward

Press the NEXT button during play to skip to the next file. Each time the button is pressed, a file is skipped within the same directory.

Skipping back

Press the PREV button during play to skip back to the beginning of the file currently play. Press the button again immediately to skip back to the beginning of the previous file.

Note:

- The files with no-MP3 extension and the folders are automatically skipped.
- To roll up and down the display, press the ▲ and ▼ buttons respectively.

INITIAL SETTINGS

Once the initial settings have been completed, the player can always be operated under the same conditions. The settings will be retained in the memory until they are changed, even if the power is turned off.

Common procedures of initial settings

1. Press the SET UP button in the stop mode. "SET UP MENU" appears on the TV screen.



2. Press the ▲, ►, ▼ or ◀ button, then press the ENTER button to select the menu. Please refer to the on-screen instructions.
3. Press the SET UP button to quit this menu.

Example:



OSD: ENGLISH
AUDIO: DISC, ENGLISH, SPANISH, FRENCH, OTHERS
SUBTITLE: DISC, ENGLISH, SPANISH, FRENCH, OTHERS
DVD MENU: DISC, ENGLISH, SPANISH, FRENCH, OTHERS
(DISC: It will use its first priority language setting.)

Note:

- You cannot switch audio sound track languages if there is only one language recorded on the disc.
- When you play a DVD disc, the player automatically displays the pre-selected subtitle language if it is included on the disc.
- If "OTHERS" is selected, enter the language code. (See "LANGUAGE CODE LIST" on Page 18.)

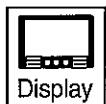

TV TYPE: 4:3 LB, 4:3 PS, 16:9

Select the appropriate your TV screen size.

4:3 LB (Letterbox):

Select when a conventional TV set is connected. When the wide screen disc is played back, the black bands appear at the top and bottom of screen.



4:3 PS (Panscan):

Select when a conventional TV set is connected. When the wide screen disc is played back, it displays pictures cropped to fill to your TV screen. The left and right edges are cut off.



Cut off Cut off

16:9 :

Select when a wide screen TV set is connected. Played in "FULL" size. (Setting the wide screen TV to "FULL" mode is also necessary.)

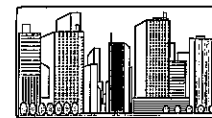

Note:

- The screen size may differ depending on the DVD discs.
- If you select 16:9 to get rid of the black bands on screen when wide screen disc is played back, picture may be slightly distorted.
- In some discs, even if 4.3 PS is selected, the black bands will remain on the screen.



D-RANGE CONTROL: OFF, ON
FRONT SPEAKER: SMALL, LARGE
CENTER SPEAKER: SMALL, LARGE
SURROUND SPEAKER: SMALL, LARGE
SUBWOOFER: YES, NO

When the supplied speakers are connected, you must set the speaker settings as follows:

D-RANGE CONTROL (Dynamic range control):

It limits a big sound. Select "ON" or "OFF".

FRONT SPEAKER/CENTER SPEAKER/SURROUND SPEAKER:

When using the supplied speakers, select "SMALL".

SUBWOOFER:

When using the supplied speaker, select "YES". If not, select "NO".



ENTER PASSWORD

Enter a number in 4 digits, then press "ENTER".



To confirm, enter password again, then press "ENTER".

Invalid password
Enter a number in 4 digits, then press "ENTER".

PARENTAL LEVEL: OFF, 1, 2, 3, 4, 5, 6, 7, 8

CHANGE PASSWORD:

CHANGE PASSWORD

Enter a number in 4 digits, then press "ENTER".



To confirm, enter password again, then press "ENTER".

Parental control

MPAA (Motion Picture Association of America) Guideline is rating system that provide advance cautionary information to parent about the content of movie programmes.

The parental lock level is equivalent to the following MPAA Rating System.

Level 7: NC-17 (No one 17 and under admitted)

Level 6: R (Restricted)

Level 4: PG13 (Parental guidance cautioned)

Level 3: PG (Parental guidance suggested)

Level 1: G (General audiences)

Some DVD discs contain a restriction level which enables parents to prevent playback of discs by children. This DVD player is equipped with a password designed to prevent children changing the level.

You cannot play DVD discs rated higher than the level you selected unless you cancel the parental lock function.

For example, when you select level "5", the DVD player will not play discs with ratings of "6", "7" or "8". The information will appear on the TV screen.

If you forget the password...

Enter "788444" to clear the current password.

Enter a new password and set the parental lock level again.

Note:

DVD discs may or may not respond to the parental lock settings. Make sure this function works with your DVD discs.

For improvement, on screen displays subject to change without notice.

LANGUAGE CODE LIST

Enter the appropriate code number for the initial settings "AUDIO", "SUBTITLE" and "DVD MENU".

Code	Abbreviation of the language	Language	Code	Abbreviation of the language	Language	Code	Abbreviation of the language	Language
6565	aa	Afar	7369	ie	Interlingue	8278	m	Kirundi
6566	ab	Abkhazian	7375	ik	Inupiak	8279	ro	Romanian
6570	af	Afrikaans	7378	in	Indonesian	8285	ru	Russian
6577	am	Amharic	7383	is	Icelandic	8287	rw	Kinyarwanda
6582	ar	Arabic	7384	it	Italian	8365	sa	Sanskrit
6583	as	Assamese	7387	iw	Hebrew	8368	sd	Sindhi
6589	ay	Aymara	7465	ja	Japanese	8371	sg	Sangro
6590	az	Azerbaijani	7473	ji	Yiddish	8372	sh	Serbo-Croatian
6665	ba	Bashkir	7487	jw	Javanese	8373	si	Singhalese
6669	be	Byelorussian	7565	ka	Georgian	8375	sk	Slovak
6671	bg	Bulgarian	7575	kk	Kazakh	8376	sl	Slovenian
6672	bh	Bihari	7576	kl	Greenlandic	8377	sm	Samoan
6673	bi	Bislama	7577	km	Cambodian	8378	sn	Shona
6678	bn	Bengali; Bangla	7578	kn	Kannada	8379	so	Somali
6679	bo	Tibetan	7579	ko	Korean	8381	sq	Albanian
6682	br	Breton	7583	ks	Kashmiri	8382	sr	Serbian
6765	ca	Catalan	7585	ku	Kurdish	8383	ss	Siswati
6779	co	Corsican	7589	ky	Kirghiz	8384	st	Sesotho
6783	cs	Czech	7665	la	Latin	8385	su	Sundanese
6789	cy	Welsh	7678	ln	Lingala	8386	sv	Swedish
6865	da	Danish	7679	lo	Laothian	8387	sw	Swahili
6869	de	German	7684	lt	Lithuanian	8465	ta	Tamil
6890	dz	Bhutani	7686	lv	Latvian, Lettish	8469	te	Telugu
6976	el	Greek	7771	mg	Malagasy	8471	tg	Tajik
6978	en	English	7773	mi	Maori	8472	th	Thai
6979	eo	Esperanto	7775	mk	Macedonian	8473	ti	Tigrinya
6983	es	Spanish	7776	ml	Malayalam	8475	tk	Turkmen
6984	et	Estonian	7778	mn	Mongolian	8476	tl	Tagalog
6985	eu	Basque	7779	mo	Moldavian	8478	tn	Setswana
7065	fa	Persian	7782	mr	Marathi	8479	to	Tonga
7073	fi	Finnish	7783	ms	Malay	8482	tr	Turkish
7074	fj	Fiji	7784	mt	Maltese	8483	ts	Tsonga
7079	fo	Faeroese	7789	my	Burmese	8484	tt	Tatar
7082	fr	French	7865	na	Nauru	8487	tw	Twai
7089	fy	Frisian	7869	ne	Nepali	8575	uk	Ukrainian
7165	ga	Irish	7876	nl	Dutch	8582	ur	Urdu
7168	gd	Scots Gaelic	7879	no	Norwegian	8590	uz	Uzbek
7176	gl	Galician	7967	oc	Occitan	8673	vi	Vietnamese
7178	gn	Guarani	7977	om	(Afan) Oromo	8679	vo	Volapük
7185	gu	Gujarati	7982	or	Oriya	8779	wo	Wolof
7265	ha	Hausa	8065	pa	Punjabi	8872	xh	Xhosa
7273	hi	Hindi	8076	pl	Polish	8979	yo	Yoruba
7282	hr	Croatian	8083	ps	Pashto, Pushto	9072	zh	Chinese
7285	hu	Hungarian	8084	pt	Portuguese	9085	zu	Zulu
7289	hy	Armenian	8185	qu	Quechua			
7365	ia	Interlingua	8277	rm	Rhaeto-Romance			

LISTENING TO VIDEO SOURCES

1. Press the FUNCTION button to select "VIDEO 1" or "VIDEO 2".
2. Follow the instructions supplied with VCR or other video equipment.

LISTENING TO THE RADIO

To turn the unit on and listen to the last received station, press the TU/BAND button on the remote control.

Automatic/Manual tuning

1. Press the FUNCTION button to select FM or AM.

When using the remote control, press the TU/BAND button instead of the FUNCTION button.

2. Automatic tuning

Press the ►►/TUNE+ or ◀◀/TUNE- button for at least 1 second to tune in a station. The unit will scan up or down the band and receive the next receivable station. Press the button again to continue.

Manual tuning

Press the ►►/TUNE+ or ◀◀/TUNE- button briefly until the desired frequency is displayed.

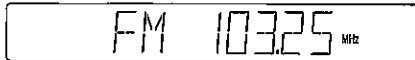

To preset stations

Up to 20 FM and 10 AM stations can be preset.

Automatic presetting (APT)

1. Press the FUNCTION button to select FM or AM.
2. Press the FWD/MEMO button for at least 3 seconds. "PROG." blinks. The automatic tuning mode is set and automatic presetting begins from the low end of the band.
When 20 FM or 10 AM stations have been preset or the high end of the band is reached, automatic presetting stops. "PROG." disappears and the station memorized on channel 1 will be heard.
3. To preset stations on the other band, follow steps above.

Note:

If APT is activated, all previously programmed stations of the band will be cleared and new stations will be programmed.

Manual presetting

1. Tune in the station to be preset as described in "Automatic/Manual tuning".
2. Press the FWD/MEMO button.

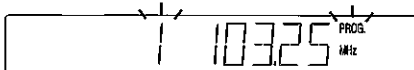

3. While "PROG." is blinking, press the REV/PRESET button to select the channel to be preset.



4. While "PROG." is blinking, press the FWD/MEMO button.
 - In this example, "103.25 MHz" FM station is preset on FM channel 9.

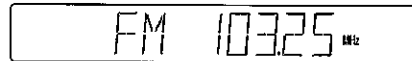

5. Repeat steps above to add more preset stations.
 - When presetting a new station, the previous preset station is cleared.

Listening to preset stations

1. Press the FUNCTION button to select FM or AM.
2. Press the REV/PRESET button briefly to select the desired channel.
 - The number buttons on the remote control can also be used. Example: Press 0, then 9.

Preset scan tuning

1. Press the FUNCTION button to select FM or AM.
2. Press the REV/PRESET button for at least 1 second. The channel number appears. Each of the preset stations is tuned in for 5 seconds.
 - The PRESET button on the remote control can also be used.
3. When the desired station has been tuned in, press the REV/PRESET button again to keep the reception locked at that station.

To receive FM stereo broadcasts

Make sure that "MONO" is not displayed. If "MONO" appears, press the FM MODE button to turn the "MONO" indication off.

"ST" appears when an FM stereo broadcast is received.

- If the signal from an FM stereo station is weak and reception is poor, press the FM MODE button to change to the MONO mode. The reception may be improved, but the sound will be monaural.

TIMER OPERATION (Using the remote control)

Using the timer

Set the on and off times, function to be used and volume level. Operation will start with the selected function at the on time. The power will be switched off at the off time.

The timer will function every day unless it is released.

Preparation

Note:

Make absolutely sure that the clock is set to the correct time before setting the timer.

- Select the function for timer operation and prepare the sources to be used.
 - If the function selected is tuner, tune in to the desired band and station.
- Adjust the volume level as desired.

Operation

1. Press the SHIFT + 7 TIMER buttons.

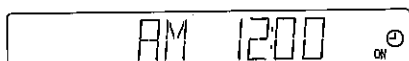

The previous timer on time setting appears.

2. Press the SHIFT + 8 ADJUST buttons within 15 seconds.

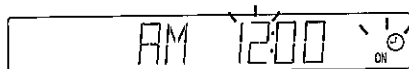

3. Set the hours of timer on time by pressing the ►| or ◀◀ button, then press the SHIFT + 8 ADJUST buttons.



Set the minutes in the same way.



The timer off time setting appears.

4. Set the timer off time as described in step 3. "Ⓞ" blinks.
5. While "Ⓞ" is blinking, press the FUNCTION button to select the source to be used.
6. Press the SHIFT + 8 ADJUST buttons.
The timer operation standby mode is activated. "Ⓞ" remains lit.
7. Press the Ⓞ/ON button to switch off the power.
 - "Ⓞ" appears while timer operation is engaged.
 - To switch off the power during a timer-controlled operation, press the Ⓞ/ON button. The timer will be set in the standby mode.

To check the timer settings

Press the SHIFT + 7 TIMER buttons repeatedly. The timer settings are displayed in the following order:

On time → Off time → Function

To change the settings, press the SHIFT + 7 TIMER buttons to select the setting to be changed, then press the SHIFT + 8 ADJUST buttons so that the display blinks. Change the setting as explained above.

To release the timer

After turning the power on, press the SHIFT + 7 TIMER buttons, then press the SHIFT + 9 SET/CLEAR.

Note:

- If the SHIFT + 9 SET/CLEAR buttons are pressed while the timer is being set, the original display returns.
- The timer mode is released if a power failure occurs during timer controlled operation.
- The timer may not operate if a power failure occurs during timer operation standby mode.

Using the sleep timer

The sleep timer automatically switches off the power after a preset time has elapsed. The volume will gradually be reduced (fade-out) during the 1-minute period before the unit turns off. There are 9 time periods available: 90, 80, 70, 60, 50, 40, 30, 20, and 10 minutes.

Press the SHIFT + 6 SLEEP buttons repeatedly to select the desired sleep time. "SLEEP" appears on the display. After several seconds, the original display returns and the brightness of the display reduces.

To check the remaining sleep time

Press the SHIFT + 6 SLEEP buttons once. After several seconds, the original display returns.

To release the sleep timer while in operation

Press the SHIFT + 9 SET/CLEAR buttons. The timer is also released if the power is switched off.

MAINTENANCE

Cleaning the unit

Clean the outside of the unit with a clean soft cloth moistened with lukewarm water. Do not use benzene, thinner or alcohol since they will mar the finish of the surfaces.

TROUBLESHOOTING GUIDE

If you have followed the instructions and are having difficulty operation the unit, locate the SYMPTOM in the left column below. Check the corresponding POSSIBLE CAUSE and CORRECTIVE ACTION columns to locate and remedy the problem.

SYMPTOM	POSSIBLE CAUSE	CORRECTIVE ACTION
No picture.	The wrong function is selected.	Select the correct function.
	No disc is loaded or an unplayable disc is loaded.	Load a disc or load a playable disc. (Check the disc logo, type, colour system and regional code.)
	The TV is not set to receive signal from the unit.	Select the correct input function on the TV.
No sound.	The wrong function is selected.	Select the correct function.
	Volume control is set to minimum.	Turn up the volume.
The playback picture is poor.	An unplayable disc is loaded.	Load a playable disc. (Check the disc logo, type, colour system and regional code.)
"⊗" appears on the TV screen.	The selected function does not operate on the disc now.	The feature or action cannot be completed at this time because: <ul style="list-style-type: none"> - The feature is not available at the moment. - The DVD software restricts it. - The DVD software does not support the feature (e.g., angles).
The player does not start play.	No disc is loaded.	Load a disc.
	An unplayable disc is loaded.	Load a playable disc. (Check the disc logo, type, colour system and regional code.)
	The disc is loaded with the label side down.	Load the disc on the disc tray correctly.
	The disc is dirty.	Clean the disc or replace it.
	"PARENTAL" is set.	Cancel the parental lock function or change the rating level. Reset it after play.
The operation or display is not normal.	The memory must be reset.	<ol style="list-style-type: none"> 1. Disconnect the mains lead. 2. While pressing both BASS and SOUND buttons at the same time, connect the mains lead. 3. Resume operation.
The remote control does not work properly.	The batteries in the remote control are weak, or installed incorrectly.	Check the battery polarity (+ or -). Replace the batteries.
	The remote control is not aimed at the remote sensor window.	Aim the remote control at the remote sensor window.

SPECIFICATIONS

Amplifier

Main amplifier

Stereo mode

30 W x 2 (at 8 ohms, 10% distortion)

Dolby Digital mode

30 W x 2 (at 8 ohms, 10% distortion, with Centre/Surround/
Subwoofer amplifier off)

Centre amplifier

30 W (at 8 ohms, 10% distortion, with Main/Surround/Subwoofer
amplifier off)

Surround amplifier

30 W x 2 (at 8 ohms, 10% distortion, with Main/Centre/Subwoofer
amplifier off)

Subwoofer amplifier

30 W (at 8 ohms, 10% distortion, with Main/Centre/Surround
amplifier off)

Inputs/Outputs:

VIDEO 1:

VIDEO IN: 1.0 Vp-p (75 Ω)

AUDIO IN (L/R): 800 mV/50 k Ω

VIDEO OUT: 1.0 Vp-p (75 Ω)

AUDIO OUT (L/R): 300 mV/2.2 k Ω

VIDEO 2:

VIDEO IN: 1.0 Vp-p (75 Ω)

AUDIO IN (L/R): 800 mV/50 k Ω

Outputs:

FRONT SPEAKERS (L/R): 8 Ω

CENTER SPEAKER: 8 Ω

SURROUND SPEAKERS (L/R): 8 Ω

SUBWOOFER: 8 Ω

COMPONENT VIDEO OUT (DVD ONLY):

Y: 1.0 Vp-p (75 Ω)

Cb: 0.7 Vp-p (75 Ω)

Cr: 0.7 Vp-p (75 Ω)

MONITOR OUT S-VIDEO (DVD ONLY):

Y: 1.0 Vp-p (75 Ω)

C: 0.286 Vp-p (75 Ω) NTSC, 0.3 Vp-p (75 Ω) PAL

MONITOR OUT VIDEO: 1.0 Vp-p (75 Ω)

DVD Player

Type:

DVD video player

Playback standard:

PAL or NTSC

Laser:

Semiconductor laser, wavelength: 650/790 nm

Laser output (Continuous wave max.):

1 mW (DVD)

0.5 mW (CD)

Signal to noise ratio:

More than 105 dB

Harmonic distortion

0.003 %

Wow and flutter:

Below measurable level

Tuner

Reception frequency:

FM: 87.5 - 108 MHz

AM: 522 - 1710 KHz

General

Power requirements:

AC 230 - 240 V, 50 Hz

Power consumption:

170 W

1.8 W (standby mode)

Dimensions:

435(W) x 90(H) x 382(D) mm

Weight:

7.9 kg

Speaker system

Front left, Front right, Centre, Surround left and Surround right speakers (SX-8501S, magnetic shield)

Unit used:

8 cm cone type, full range

Maximum power handling capacity:

60 W (peak)

Nominal impedance:

8 Ω

Dimensions:

150(W) x 110(H) x 115(D) mm

Weight:

0.75 kg/speaker

Subwoofer (SX-8501W)

Unit used:

13 cm cone type

Maximum power handling capacity:

60 W (peak)

Nominal impedance:

8 Ω

Dimensions:

180(W) x 390(H) x 290(D) mm

Weight:

5.7 kg

IMPORTANT INFORMATION

Because its products are subject to continuous improvement, SANYO reserves the right to modify product designs and specifications without notice and without incurring any obligation.

