

SANYO

INSTRUCTION
MANUAL

CD Portable
FM Stereo / AM Radio
Cassette Recorder

MCD-Z16F

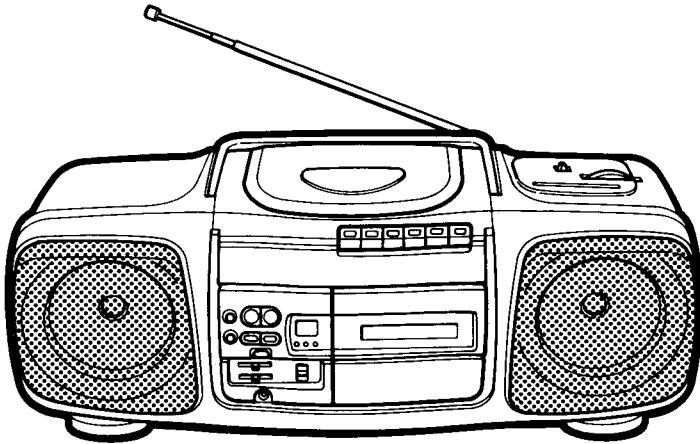

CAUTION

USE OF CONTROLS OR ADJUSTMENTS OR PERFORMANCE OF PROCEDURES OTHER THAN THOSE SPECIFIED IN THE OPERATING INSTRUCTIONS MAY RESULT IN HAZARDOUS RADIATION EXPOSURE.

THE COMPACT DISC PLAYER SHOULD NOT BE ADJUSTED OR REPAIRED BY ANYONE EXCEPT PROPERLY QUALIFIED PERSONNEL.

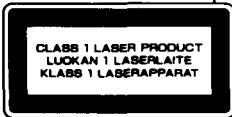
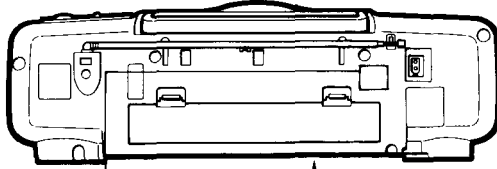

CAUTION - INVISIBLE LASER RADIATION WHEN OPEN AND INTERLOCKS DEFEATED. AVOID EXPOSURE TO BEAM.

ADVARSEL - USYNLIG LASER STRÅLING VED ÅBNING, NÅR SIKKERHEDSAFBRYDERE ER UDE AF FUNKTION. UNDGÅ UDSÆTTELSE FOR STRÅLING.

VARNING - OSYNLIG LASER STRÅLNING NÅR DENNA DEL ÄR ÖPPNAD OCH SPÄRR ÄR URKOPPLAD. STRÅLEN ÄR FARLIG.

VORSICHT - UNSICHTBARE LASERSTRAHLUNG TRIT AUS, WENN DECKEL GEÖFFNET UND WENN SICHERHEITSVERRIEGELUNG ÜBERBRÜCKT IST. NICHT, DEM STRAHL AUSSETZEN.

VARO! Avattaessa ja suojalukitus ohitettaessa olet alltiina näkymättömälle lasersäteilylle. Älä katso säteeseen.



FOR SAFE AND EFFICIENT OPERATION

- The apparatus shall not be exposed to dripping or splashing.
- Do not damage the mains lead.
- When not in use, disconnect the mains lead from the outlet. Grasp the plug, not the lead, when disconnecting the unit.
- If water should enter the unit, electrical shock or a malfunction may result. Use in an area where there is low humidity and little dust.
- Do not disassemble or alter the unit in any way.
- Do not use the unit in areas where extremes in temperature occur (below 5°C or exceeding 35°C), or where it may be exposed to direct sunlight.
- Because of the CD player's extremely low noise and wide dynamic range, there is a tendency to turn the volume on the amplifier higher than necessary.

Doing so may produce an excessively high output from the amplifier which can cause damage to your speakers. Please be careful in this regard.

- Sudden changes in the surrounding temperature can cause dew to form on the optical pickup lens inside the unit. Under this condition the unit may be unable to operate properly. If this should occur, remove the disc and allow the player to adjust to the surrounding temperature.

POWER SUPPLY

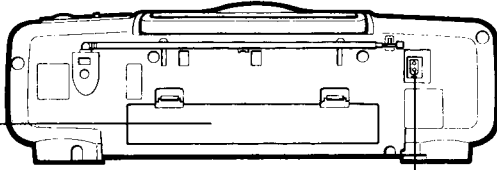

Battery power operation

Install batteries.
Observe + and - signs.

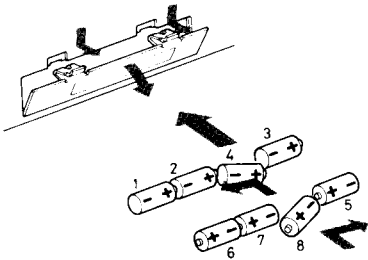

8 "D" size batteries

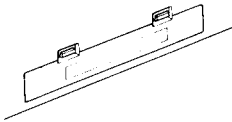

Replace lid.

AC power operation

Take out the cord and
connect it.

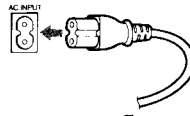

230 ~ 240V AC, 50Hz

NOTE:

When the AC mains lead is connected to the unit, the installed batteries will be automatically disconnected.

CAUTION:

WHEN INSTALLING THE BATTERIES

To prevent leakage from the batteries, which is corrosive and can cause personal injury and damage to the unit, observe the following precautions:

1. The batteries must be installed correctly. Match the polarities (+ and - signs) on the batteries, to the polarities shown on the back of the unit.
2. Do not mix new batteries with old or used batteries.
3. Only use batteries of the same type and brand.

4. If the unit will not be used for an extended period of time, remove the batteries and store them in a cool place.
5. Carefully follow the battery manufacturer's instructions for proper use and disposal.
6. DO NOT ALLOW YOUNG CHILDREN TO HANDLE BATTERIES.

NOTE:

When the batteries have become discharged, they must be disposed of in a safe manner that complies with all applicable laws.

COMPACT DISC OPERATION

CD PLAY

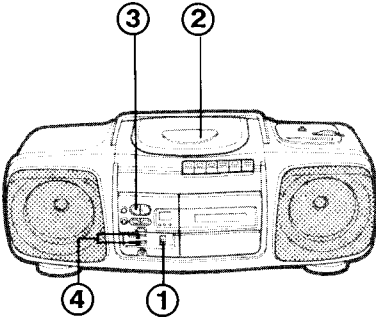

① To CD.

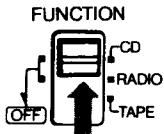

② Push down.

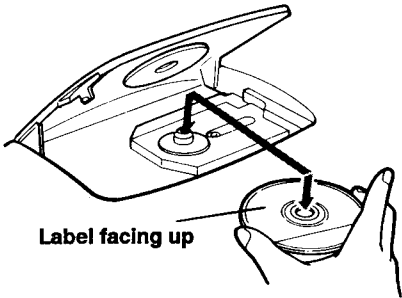
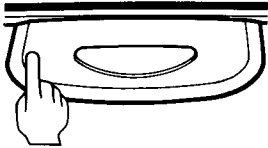

Push down.

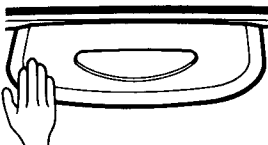

③ Press PLAY/PAUSE.

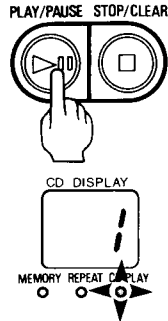

The CD PLAY indicator will light.

④ To control the sound.

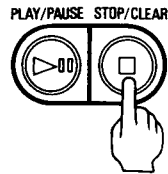
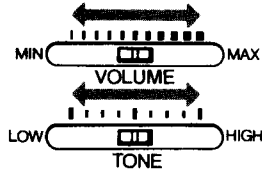

Press STOP/CLEAR.

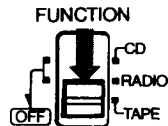

To OFF (TAPE).

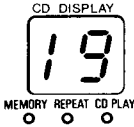

The CD DISPLAY will show the total number of tracks on the disc as shown below.

TRACKS	CD DISPLAY
1 ~ 19	1 ~ 19
More than 19	"0" Flashes

Table

NOTES:

- If a disc is loaded upside down, or if no disc is loaded, the CD player will not operate.
- Opening the CD compartment lid while a CD is playing could scratch the disc. Always press the STOP/CLEAR button and wait for the disc to stop rotating before opening the CD compartment lid.



BASS switch

- Button in: Increases the bass output level.
- Button out: For normal bass output level.

Compact discs

- Both 8cm and 12cm discs can be played in this unit.
- NOTE: Place only one disc at a time in the CD compartment.
- Only discs bearing the logo as shown can be played in this unit.



- Always place the compact disc in the CD compartment with the label facing up. Compact discs can be played on only one side.
- Fingerprints and dust should be carefully wiped off the disc's signal surface (opposite the label side) with a soft cloth. Gently wipe in a straight motion from the inside to the outside of the disc.
- Discs should be returned to their cases after use to avoid serious scratches which could cause the player to skip.
- Do not expose a disc to direct sunlight, high humidity, or high temperatures for extended periods of time to prevent warping the disc.
- Do not apply paper or write anything on the surface of the disc.
- Do not use cleaners or antistatic sprays on discs, such as those used for phonograph records.

IMPORTANT NOTE

If an abnormal display indication, or an operating problem occurs, disconnect the AC mains lead. Remove the "D" batteries (see page 2). Wait at least 5 seconds, then reconnect the AC mains lead. Reinstall the "D" batteries.

PLAY/PAUSE STOP/CLEAR

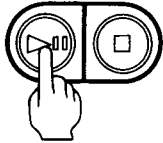

PAUSE MODE

1. Press the PLAY/PAUSE button during play. Play will temporarily stop, and the CD PLAY indicator will flash.
2. Press the PLAY/PAUSE button again to resume play. The CD PLAY indicator will remain ON.

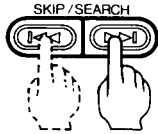

Press and hold down during playback

TRACK SEARCH

1. In the play mode, press and hold down the "◀◀" or "▶▶" SKIP/SEARCH button to lower the volume level and quickly advance or return to any part of the disc. The CD DISPLAY will flash.
2. Release the "◀◀" or "▶▶" SKIP/SEARCH button to return the volume to normal level and resume play.

NOTE:

If the "◀◀" or "▶▶" SKIP/SEARCH button is pressed during the PAUSE mode, no sound will be heard, and the PAUSE mode will continue when the button is released.

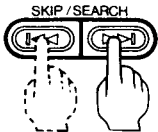

Press and release repeatedly

TRACK SKIP

1. Press and release the "◀◀" or "▶▶" SKIP/SEARCH button repeatedly during play to quickly locate the beginning of a track.
2. The CD DISPLAY will show the number of the selected track. Play will continue from the beginning of the new track.

NOTE:

If the "◀◀" or "▶▶" SKIP/SEARCH button is pressed while the unit is in the PAUSE mode, the unit will remain in the PAUSE mode when the button is released.

Using headphones

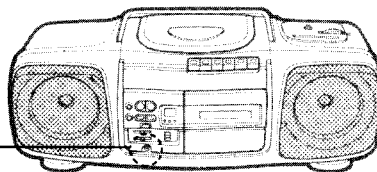

PROGRAMMED PLAY

With programmed play, up to 16 tracks on a disc can be memorized and played in any order.

TO PROGRAM

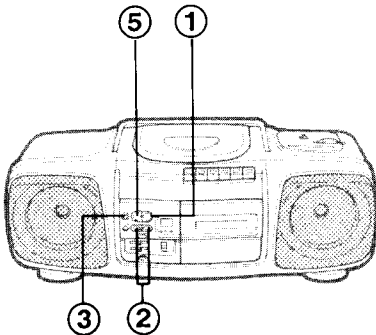

① Press STOP/CLEAR.

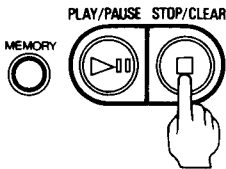

② Press **⏮** or **⏭**.

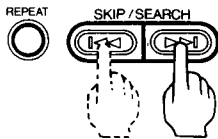

③ Press MEMORY.

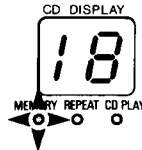
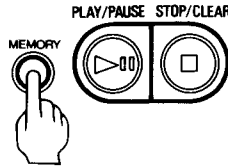

- The MEMORY indicator will light on the unit.

④ Repeat 2 and 3 to memorize additional tracks.

Checking the program

Press MEMORY.

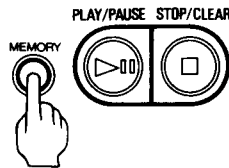

To view the memorized track numbers, in the order they were entered.

TO BEGIN PROGRAM PLAY

⑤ Press PLAY/PAUSE.

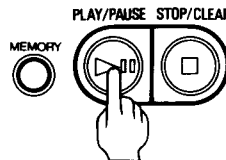

Programmed play will begin.

- To cancel programmed play, press STOP/CLEAR twice. The MEMORY indicator will go off.

REPEAT PLAY

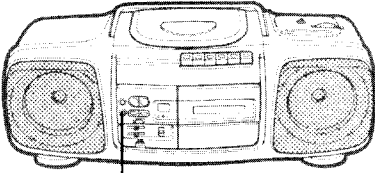

REPEAT

Press REPEAT before or during play (or programmed play).

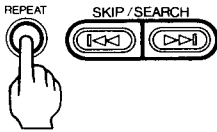

- The REPEAT indicator will light on the unit.

To cancel repeat play

Press REPEAT again.

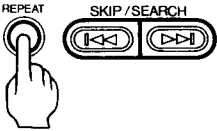

- The REPEAT indicator will go off.

RADIO OPERATION

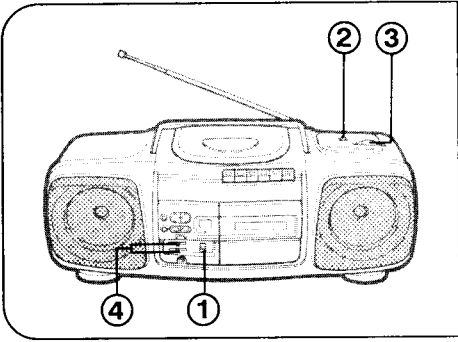

① **To RADIO.**
 FUNCTION

 CD
 RADIO
 TAPE
 OFF

② **To AM or FM.**

 BAND
 AM FM

③ **Tune in a station.**

 TUNING
 FM MHz
 AM kHz
 Dial pointer

To OFF (TAPE).
 FUNCTION

 CD
 RADIO
 TAPE
 OFF

④ **To control the sound.**

 MIN MAX
 VOLUME
 LOW HIGH
 TONE

NOTE:
 The unit will automatically switch to stereo when an FM stereo broadcast is received.

To improve reception

FM - Extend and change position.

AM - Rotate unit.

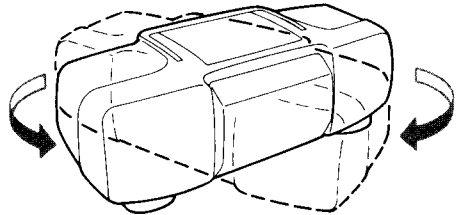
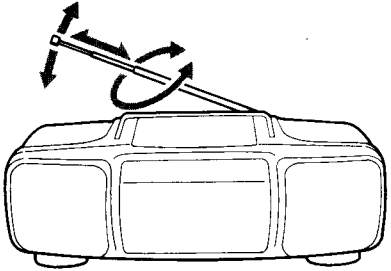

CASSETTE TAPE OPERATION

PLAYBACK

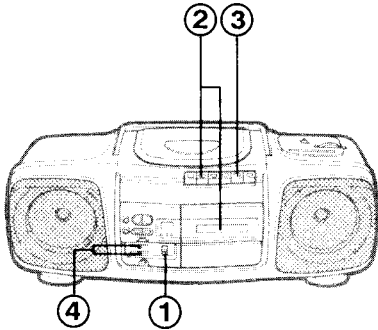

① To TAPE.

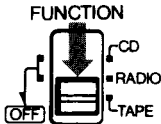

② Press STOP/EJECT. Insert cassette.

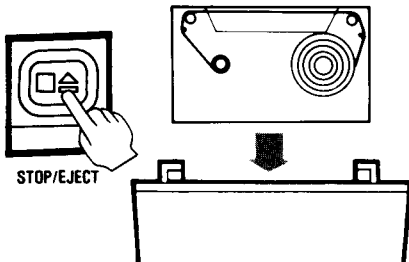

③ Press PLAY.

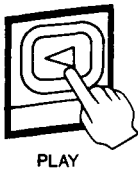

Press to temporarily stop the tape during playback or recording. Press it again to continue.

To quickly wind the tape forward

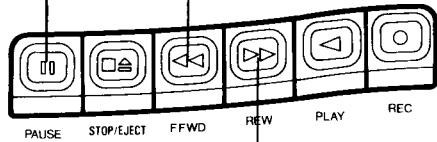

To quickly wind the tape backward

Full automatic stop

This unit has a full-release stop system to protect the tape and prevent-pinch roller damage. When the end of the tape is reached in Playback, Recording, Fast forward or Rewind, the tape mechanism will automatically stop.



Press STOP/EJECT once to stop tape. Press again to remove cassette.

④ To control the sound.

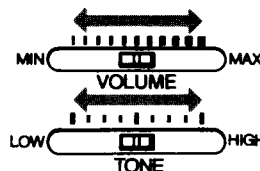

RECORDING (RADIO)

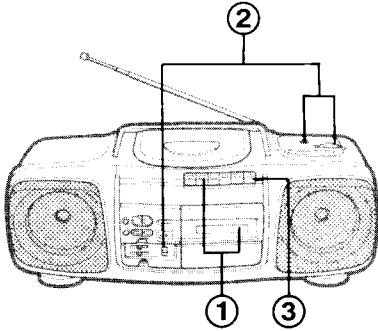

- ① Press STOP/EJECT.
Insert cassette.

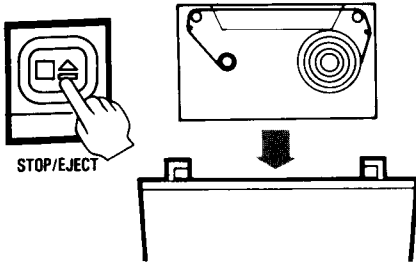

- ② To RADIO

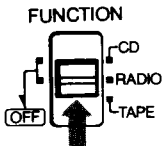

To FM or AM. Tune in a station.

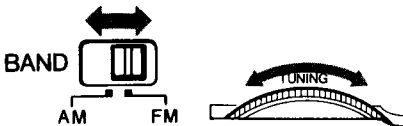

- ③ Press REC.

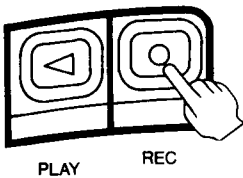

Automatic Level Control (ALC) recording
The ALC circuit adjusts the recording input level automatically. No adjustments are required.

Safeguards against accidental erasure

To protect side A, break out tab (1). To protect side B, break out tab (2).

NOTE:

A cassette with the erase guard tabs removed cannot be erased or used for recording and the REC button cannot be depressed. To record or erase a protected cassette, cover the tab openings with adhesive tape (3).

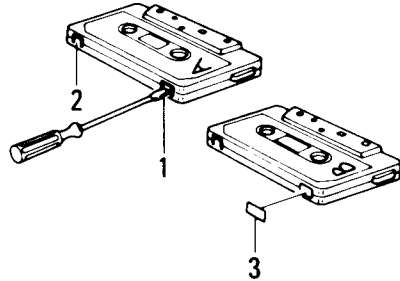

Press STOP/EJECT once to stop tape.
Press again to remove cassette.

RECORDING (CD)

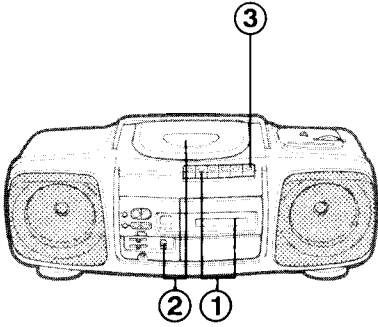

- ① Press STOP/EJECT. Insert cassette.

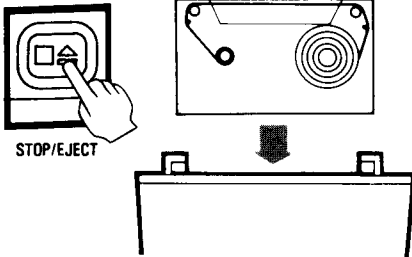

- ② To CD.

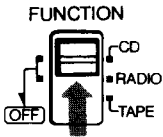

- ③ Press REC.

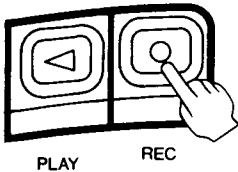

WARNING

Recording copyright material without permission of the copyright owners is usually an infringement. If you wish to re-record copyright material, permission from the copyright owner is necessary. SANYO does not approve of, and cannot be held responsible for, any unlawful use of this machine.

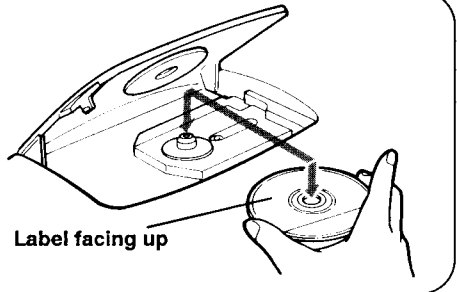

Label facing up

Synchronous recording (CD-to-TAPE SYNCHRO DUBBING)

This recording system starts disc play and cassette recording at the same time.

When the REC button is pressed, recording will start at the beginning of track number 1 of the disc.

If a program has been entered, recording will start from the beginning of the first programmed track.

MAINTENANCE

Cleaning the unit

Clean the outside of the unit with a clean soft cloth, moistened with luke-warm water. Do not use solvents such as benzene or thinner. These will permanently damage the units finish.

Cleaning the tape heads

When dust or reddish-brown oxide builds up on the tape deck heads, pinch roller and capstan, the following problems may result:

Poor sound quality during playback
Distorted, poor quality recordings
Erratic tape speed during recording or playback

1. Press the STOP/EJECT button to open the cassette compartment lid.
2. Press the REC button while holding the lever down as shown.

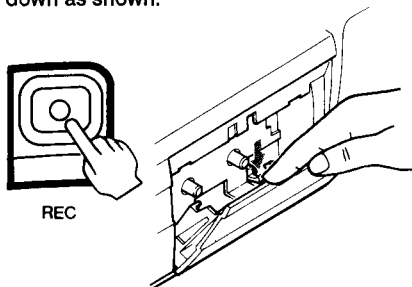

3. Moisten a cotton swab (1) with Isopropyl alcohol or special head cleaning fluid. Gently rub the face of each head (4, 5) with alcohol. Also clean the capstan (2) and pinch roller (3).

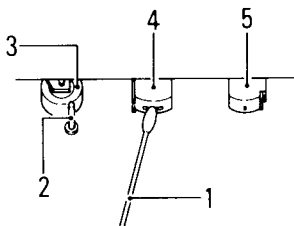

Cleaning the CD player lens

The lens should never be touched. If dust is on the lens, blow it off using a camera lens blower. (Please consult your dealer.)

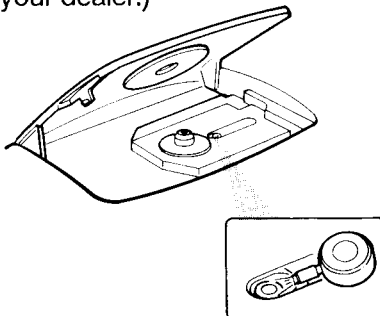

If trouble occurs ...

To avoid the hazard of electric shock and damage to the unit, have the unit bench tested by an authorized SANYO service station. Do not remove the unit from its cabinet to attempt repairs yourself.

SPECIFICATIONS

(CASSETTE SECTION)

Recording system:
AC bias, 4-track stereo
Erasing system:
Magnet erase
Tape speed:
4.75 cm/sec.
Fast forward and rewind time:
110 sec. (C-60 tape)
Frequency response:
80 ~ 12,000 Hz (Normal tape)

(CD SECTION)

Channels:
2 channels
S/N ratio:
70 dB
Wow & Flutter:
undetectable
Sampling frequency:
44.1 kHz
Quantization:
16 bits linear/ch
Pick up light source:
Semi-conductor laser
Pick up wave length:
790 nm

(RADIO SECTION)

Tuning ranges :
AM: 525 ~ 1,710 kHz
FM: 88 ~ 108 MHz
Aerials:
Built-in ferrite bar and telescopic aerials

(GENERAL)

Output power:
4.0 W x 2 (DC max.)
Speaker:
12 cm x 2, 4 ohms
Terminal impedance
PHONES: 32 ohms
Power source:
AC: 230 ~ 240 V, 50 Hz
DC: 12 V (8 "D" size batteries)
Dimensions:
556 x 170 x 215 mm (W x H x D)
Weight (approx.):
3.4 kg without batteries

Specifications subject to change without notice.

1AD6P10A32401
(AU)

SANYO

SANYO Electric Co., Ltd.

Printed in Singapore