

SANYO

INSTRUCTION MANUAL

MCD-ZX300F

**CD Portable
Radio Cassette Recorder**

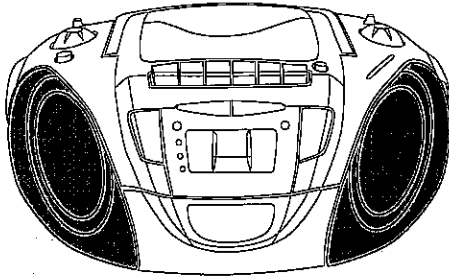

PRECAUTIONS

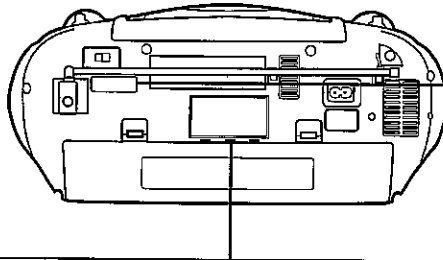

CLASS 1 LASER PRODUCT
LUOKAN 1 LASERLAITE
KLASS 1 LASERAPPARAT

CAUTION-INVISIBLE LASER RADIATION WHEN OPEN AND INTERLOCKS DEFEATED. AVOID EXPOSURE TO BEAM.

ADVARSEL-USYNLIG LASER STRÅLING VED ÅBNING, NÅR SIKKERHEDSAFBRYDERE ER UDE AF FUNKTION, UNDGÅ UDSÆTTELSE FOR STRÅLING.

VARNING-OSYNLIG LASER STRÅLNING NÅR DENNA DEL ÄR ÖPPNAD OCH SPÄRR ÄR URKOPPLAD. STRÅLEN ÄR FARLIG.

VORSICHT!-UNSIHTBARE LASERSTRAHLUNG TRITT AUS, WENN DECKEL GEÖFFNET UND ENN SICHERHEITSVERRIEGELUNG ÜBERBRÜCKT IST. NICHT, DEM STRAHL AUSSETZEN.

VARO I-Avattaessa ja suojalukitus ohitettaessa olet alttiina näkymättömälle lasersäteilylle. Älä katso säteeseen.



CAUTION - USE OF CONTROLS OR ADJUSTMENTS OR PERFORMANCE OF PROCEDURES OTHER THAN THOSE SPECIFIED IN THE OPERATION INSTRUCTION MAY RESULT IN HAZARDOUS RADIATION EXPOSURE.

THIS PRODUCT SHOULD NOT BE ADJUSTED OR REPAIRED BY ANYONE EXCEPT PROPERLY QUALIFIED PERSONNEL.

- The apparatus shall not be exposed to dripping or splashing.
- No objects filled with liquids, such as vases, shall be placed on the apparatus.
- Do not use where there are extremes of temperature (below 5°C or exceeding 35°C).
- Because of the CD player's extremely low noise and wide dynamic range, there might be a tendency to set the volume on the amplifier unnecessarily high. Doing so may produce an excessively large output from the amplifier which could damage your speakers.
- Sudden changes in the ambient temperature may cause condensation to form on the optical lens inside the unit. If this happens, take out the disc, leave the unit for about 1 hour, and then proceed to operate.
- Do not install this equipment in a confined space, such as a book case or built in cabinet.
- The rating label is located on the back of the unit.

CONTROLS

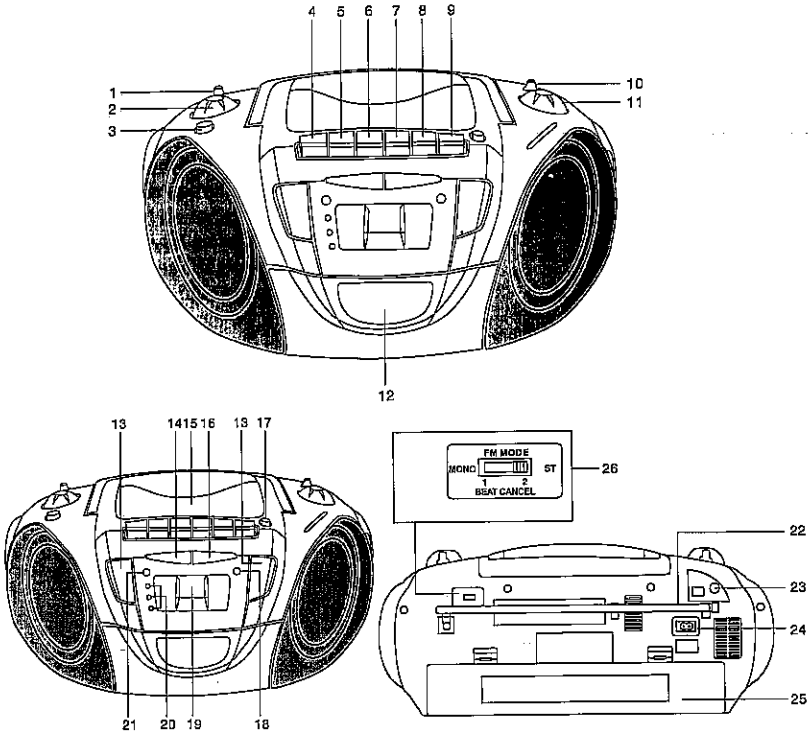

1. Function switch (FUNCTION)
2. Volume control (VOLUME)
3. Bass expander button (BASSXPANDER)
4. Pause button (PAUSE)
5. Stop/Eject button (STOP/EJECT)
6. Fast Forward button (FFWD)
7. Rewind button (REW)
8. Play button (PLAY)
9. Record button (REC)
10. Radio band switch (BAND)
11. Tuning control (TUNING)
12. Cassette holder
13. Skip/Search buttons(SKIP/SEARCH)
14. Stop/Clear button (STOP/CLEAR)
15. CD Compartment Lid
16. Play/Pause button (PLAY/PAUSE)
17. CD Compartment Opening button (CD OPEN)
18. Repeat button (REPEAT)
19. CD track number display (CD TRACK NO.)
20. Indicators (CD PLAY, MEMORY, REPEAT)
21. Memory button (MEMORY)
22. Telescopic aerial
23. Headphones socket (PHONES)
24. AC input socket (AC INPUT)
25. Battery compartment lid
26. FM mode/Beat cancel switch (FM MODE/BEAT CANCEL)

POWER SUPPLY

AC POWER

Connect one end of the mains lead to the AC INPUT socket and the other end to an AC outlet.

Note:

- The installed batteries are automatically disconnected when the mains lead is connected to the unit.
- The FUNCTION switch is mounted on the secondary side. The unit is not disconnected from mains, even switched off.

BATTERY POWER

Installing batteries

Install eight "D/R20" batteries (not supplied) as shown below.

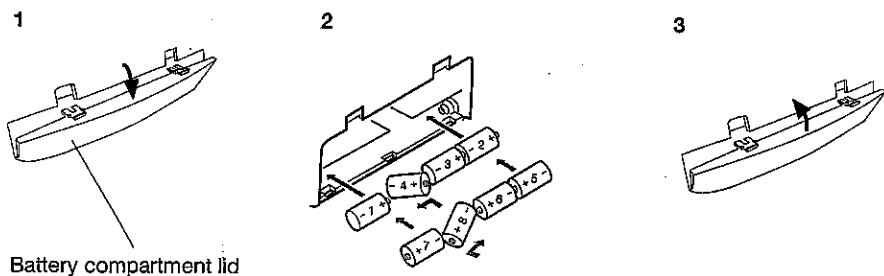

GENERAL OPERATION

Adjusting the volume

Turn the VOLUME control.

Bass expander button

Press the BASSXPANDER button to ON to enhance the bass sound.

Headphones

Connect stereo headphones (not supplied) to the PHONES socket for monitoring or for private listening. The speakers are automatically disconnected when headphones are connected.

CD PLAY

Use compact discs bearing the symbol shown below. In addition to conventional 12 cm CDs, this system can be used to play 8 cm CDs without an adapter.



1. Set the FUNCTION switch to CD.
2. Press the CD OPEN button. The CD compartment opens.
3. Place the disc with the label facing up on the turntable. (Place only one disc at a time.)

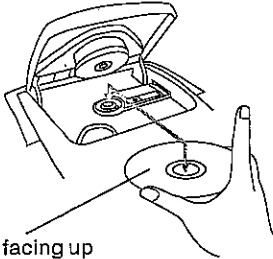

Label facing up

4. Press the CD compartment lid (PUSH TO CLOSE portion) to close it. The total number of track on the disc appears on the CD TRACK NO. display.
5. Press the PLAY/PAUSE button.

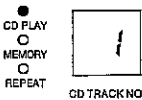

The CD PLAY indicator lights and the current track number appears. Play starts from the first track.

- To start play from the desired track, select the track by using the SKIP/SEARCH buttons, then press the PLAY/PAUSE button.

Note:

If a disc is loaded upside down, or if no disc is loaded, the CD player will not operate.

6. Press the STOP/CLEAR button to end disc play. When the last track has been played, the player stops automatically.
7. To turn the CD player off, set the FUNCTION switch to TAPE/OFF.

Note:

Do not open the CD compartment during CD play. Always press the STOP/ CLEAR button and wait for the disc to stop rotating before opening the CD compartment.

This unit can play back the CD-R/RW as well. However, some CD-R/RWs can not be played back depending on the recording conditions.

Notes on handling compact discs

- Do not expose the disc to direct sunlight, high humidity or high temperatures for extended periods of time.
- Discs should be returned to their cases after use.
- Do not apply paper or write anything on the disc surface.
- Handle the disc by its edge. Do not touch the playing surface (glossy side).
- Fingerprints and dust should be carefully wiped off the playing surface of the disc with a soft cloth. Wipe in a straight motion from the center to the outside of the disc.
- Never use chemicals such as record cleaning sprays, antistatic sprays or fluids, benzene or thinner to clean compact discs.

Temporarily stopping play

Press the PLAY/PAUSE button. The CD PLAY indicator blinks. To resume play, press the button again.

Skip play

To skip to track 6 while track 3 is playing, press the ►► SKIP/ SEARCH button repeatedly until "6" appears on the display. To skip back to track 3 while track 6 is playing, press the ◄◄ SKIP/ SEARCH button repeatedly until "3" appears.

Search (forward/reverse)

If the ►► or ◀◀ SKIP/SEARCH button is pressed during play, the player will search at high speed in the forward or reverse direction while the button is being pressed. When the button is released, normal play will continue.

Repeat play

Press the REPEAT button before or during play (or programmed play).

Each time the button is pressed, the repeat mode change as follows.

The REPEAT indicator blinks:

One track repeat mode.

The REPEAT indicator lights:

All tracks repeat mode.

The REPEAT indicator goes out:

Normal play mode.

PROGRAMMED PLAY

Up to 19 tracks on a disc can be programmed for play in any order.

- To begin the programming procedure, select "CD" function first.
- The same track can be programmed more than once.
- Load a disc that you want to programme before starting programmed play.

1. Press the STOP/CLEAR button if necessary.
2. Press the MEMORY button. The MEMORY indicator and "0" blink.
3. Select a track by using the SKIP/SEARCH buttons.
4. Press the MEMORY button.
5. Repeat steps 3 - 4 to programme additional tracks.
6. Press the PLAY/PAUSE button to start play. The MEMORY indicator blinks.
When all programmed tracks have been played, the player stops automatically.
 - The programme contents are retained in memory.

To cancel programmed play, press the STOP/CLEAR button twice.

Checking the programme

Each time the MEMORY button is pressed in the stop mode, the programmed details sequentially appear on the display.

WHAT TO DO IF..

If an abnormal display indication or an operating problem occurs, disconnect the mains lead and remove all batteries. Wait at least 5 seconds then reconnect the mains lead and reinstall the batteries. Resume the operation.

LISTENING TO TAPES

1. Set the FUNCTION switch to TAPE.
2. Press the STOP/ EJECT button. The cassette holder opens.
3. Load the cassette into the cassette holder.

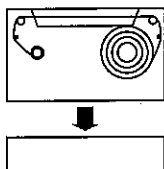

After loading the cassette, press the cassette holder back into position.

4. Press the PLAY button to begin playback.
 5. Press the STOP/ EJECT button to stop playback at any time. Press it again to remove the cassette.
- When the end of the tape has been reached, the tape stops automatically.

Note:

- Use the normal tape (TYPE 1).
- Endless tapes cannot be used.
- Do not use C-100 (or longer) tapes. They may jam in the mechanism.

Pause

Press the PAUSE button to temporarily stop playback or recording. Press it again to resume operation.

Fast forward and rewind

Press the FFWD or REW button. When the desired location has been reached, or the tape has been wound to the end, press the STOP/ EJECT button.

Automatic stop system

At the end of the tape while recording or playing back, the cassette deck stops automatically and the buttons are released.

This system does not work in fast forward and rewind operation. Be sure to press the STOP/EJECT button when the end of the tape has been reached.

Example (When using C-60 tape):

Press the STOP/EJECT button after approximately 2 minutes have elapsed under fast forward and rewind operation.

LISTENING TO THE RADIO

1. Set the FUNCTION switch to RADIO.
2. Select the desired radio band with the BAND switch.
3. Tune in a desired station by turning the TUNING control.
4. To turn the radio off, set the FUNCTION switch to TAPE/OFF.

To receive FM stereo broadcasts

Set the FM MODE switch to ST.

- If the signal from an FM stereo station is weak and reception is poor, set the FM MODE switch to MONO. The reception may be improved, but the sound will be monaural.

To improve reception

- FM: Pull out the telescopic aerial and adjust its position.
- AM: Rotate the unit.

RECORDING

Recording copyright material without permission of the copyright owners is usually an infringement. If you wish to re-record copyright material, permission from the copyright owner is necessary. SANYO does not approve of, and cannot be held responsible for, any unlawful use of this machine.

Recording compact discs (Synchronous recording)

1. Load a blank cassette.
2. Select "CD" function.
3. Load the disc to be recorded.
 - Select the track number if required.
 - For programmed recording, programme the material in advance (as described under "PROGRAMMED PLAY").
4. Press the REC button. The PLAY button is engaged simultaneously and CD recording starts.
5. Press the STOP/EJECT button to stop recording.

Recording from the radio

1. Load a blank cassette.
2. Tune in the radio station to be recorded.
3. Press the REC button to start recording.
4. Press the STOP/EJECT button to stop recording.

When beat is heard

Beat (a high-pitched noise) may sometimes be heard during the recording of radio broadcasts. If this occurs, set the BEAT CANCEL switch to the position that reduces the level of the beat noise.

Safeguards against accidental erasure

To protect side A, break out tab (1). To protect side B, break out tab (2).

- To erase or record a protected cassette, cover the tab openings with adhesive tape (3).

Note:

The REC button cannot be depressed when using a protected cassette.

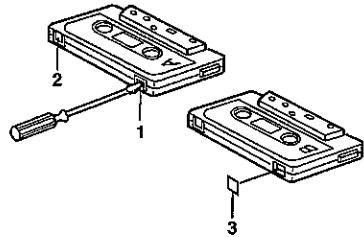

MAINTENANCE

Cleaning the tape heads

To ensure continued high performance, use a cleaning tape (available from your local audio dealer) to clean the head block of the deck after about every 10 hours of use.

Cleaning the unit

Clean the outside of the unit with a clean soft cloth, moistened with lukewarm water. Do not use benzene, thinners, or alcohol since they will mar the finish of the surfaces.

Cleaning the CD player lens

The lens should never be touched. If dust is on the lens, blow it off using a camera lens blower. (Consult your dealer.)

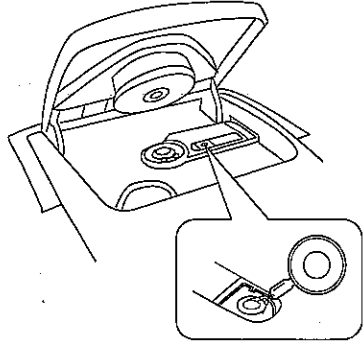

SPECIFICATIONS

CD Player

Channels:

2-channel stereo

Sampling frequency:

44.1 kHz

Pick-up :

Semiconductor laser

Laser output:

0.6mW (Continuous wave max.)

Wave length:

790 nm

Wow & Flutter:

Below measurable limits

Radio

Reception frequency:

FM: 87.5 ~ 108 MHz

AM: 526.5 ~ 1606.5 kHz

Cassette deck

Track system:

4-track, 2-channel stereo

Erasing system:

Magnet erase

Tape speed:

4.75 cm/sec.

Frequency response:

80 ~ 12,000 Hz

Fast forward / rewind time:

Approx.110 sec. (C-60)

General

Output power :

2W/ch (DC max.)

Speakers:

10 cm x 2

Terminals:

PHONES: 32 ohms

Power source:

AC: 230~240V, 50Hz

DC:12V, 8 "D/R20" batteries

Dimensions:

380(W) x 170(H) x 260 (D)mm

Weight :

Approx.2.7 kg (not including batteries)

Specifications subject to change without notice.



(AU) 1AD6P1P1743--

SANYO

SANYO Electric Co., Ltd.
Printed in China