

# SANYO

## User guide

## VHR-VK910A VHR-VK310A

## Video cassette recorder

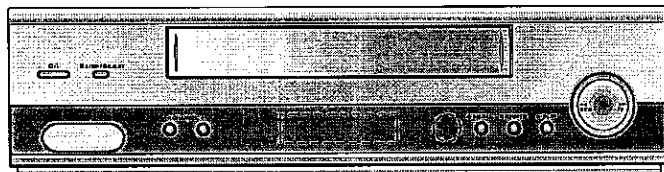
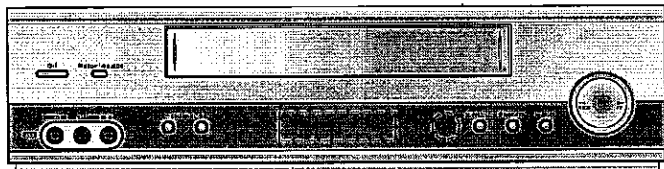

Before connecting, operating or adjusting your new Video, please read this user guide carefully. Thank you.

**Hi-Fi**  
**MONO**

**VHS**  
PAL

# Contents, safety and cleaning

Please read the following information carefully.

2

<b>Contents</b>	
Introducing your Video and remote control	3
Connecting to a television	4
Tuning TV stations	5
Adjusting TV stations manually	6
Operating your Video	7
Recording television programs	8
Timer recording	9
Advanced functions	10-13
Troubleshooting	14
Technical specifications	15

## Safety

- Position your Video so that no bright light or sunlight falls directly onto it.
- Care should be taken not to expose your Video to any unnecessary vibration, moisture, dust or heat.
- During electrical storms it is advisable to unplug both the aerial cable and mains plug to prevent accidental damage to your Video and TV.
- Do not operate your Video if it is damaged.
- If your Video still does not operate properly, unplug it and call your dealer. Your Video should not be repaired by anyone except qualified service personnel.
- Never remove the top cover of your Video as this can expose you to very high voltage and other hazards.

- Ensure that your Video is placed in a position to allow a free flow of air.
- The apparatus shall not be exposed to dripping or splashing and that no objects filled with liquids, such as vases, shall be placed on the apparatus.

## Cleaning

- 1 Unplug the Video from the mains supply.
- 2 Clean the cabinet with a soft damp cloth, do not apply liquid cleaners or aerosol cleaners.

Never spray cleaning liquids on or near the Video.

## Video head cleaning

Whenever a video cassette is inserted into or ejected from your video the video head is automatically cleaned. This should mean that additional head cleaning should not be necessary. However dirt accumulating on the head after a long period of time can cause the playback picture to become blurred or broken up. High quality video cassette tapes will not normally deposit dirt onto the video head, but old or damaged tapes might.

# Introducing your Video and Remote Control

Most of your Video's functions are accessed using the Remote Control. A summary of the functions of the main buttons are shown below (right), other buttons are described elsewhere in this guide.

Basic functions of your Video can also be operated using the control panel on the front of your Video.

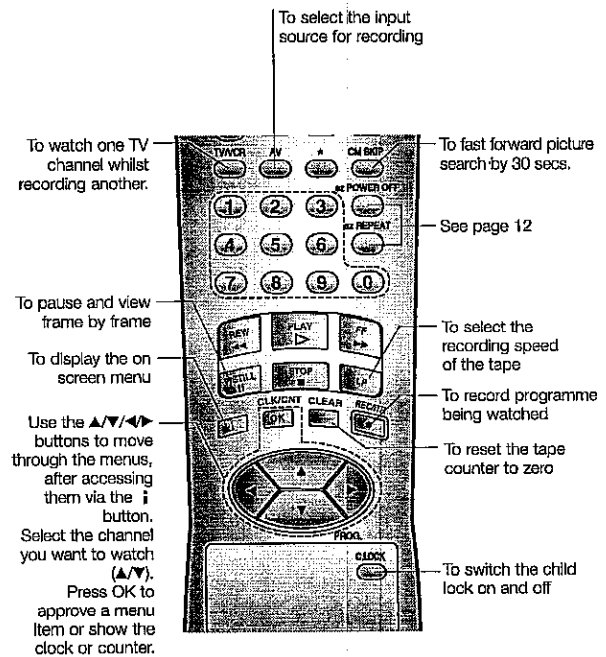
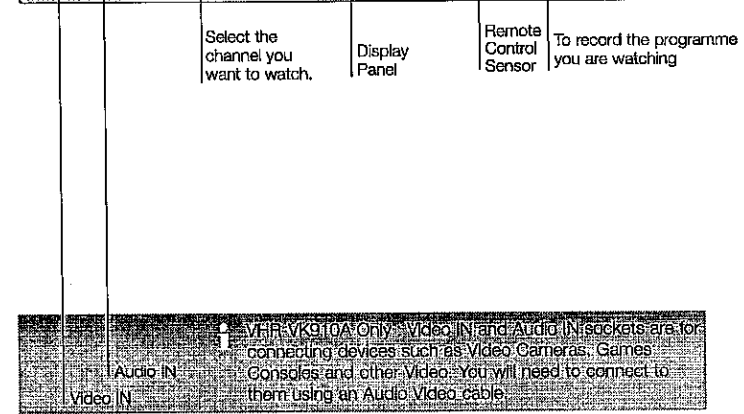
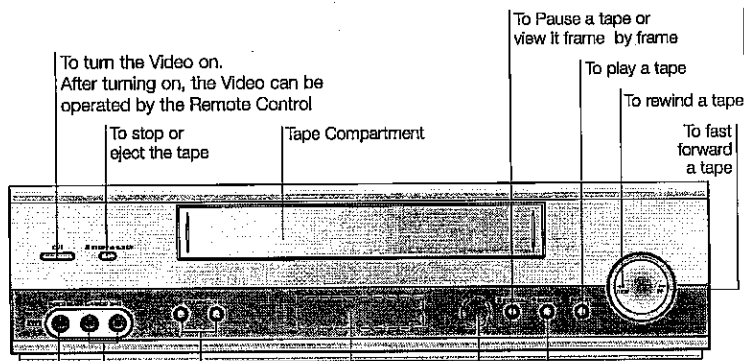

★ Feature is not available

Don't forget to install three AAA type batteries in the Remote Control.

# Connecting to a television

The information given here refers to the two most common forms of connection. Make sure that all the appliances are unplugged from the mains power, before making any connections to avoid causing damage to your equipment. Using an AV cable to connect your appliances will give you the best sound and picture quality.

4

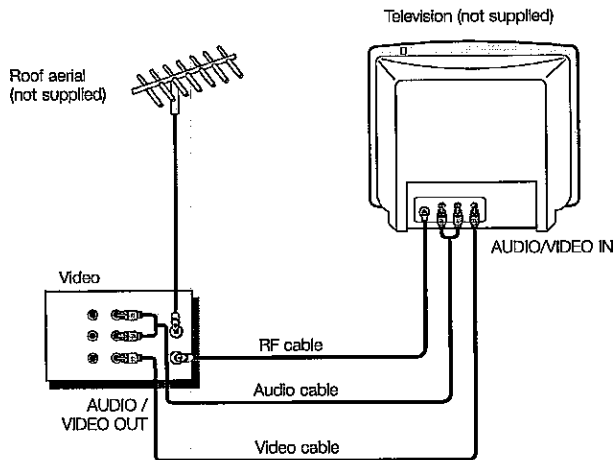

Note : V1R-VK310A has no AUDIO IN (R) and AUDIO OUT (R) sockets.

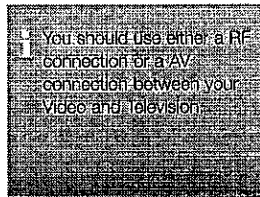
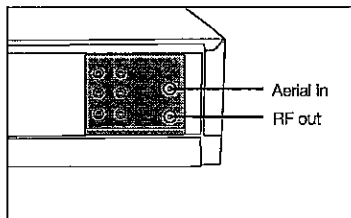

You should use either a RF connection or a AV connection between your Video and television.

## Connection guide

### Roof aerial

Your outside aerial should be connected to the AERIAL socket on your television.

### RF cable

If you are using the RF cable a connection needs to be made from the RF. OUT socket on your Video to the aerial socket on your television.

### AV socket

If you have a AV socket connection on your television you can connect the television's AUDIO IN/VIDEO IN sockets to the AUDIO OUT/VIDEO OUT sockets on the back of the Video.



## Tune a video channel

If you are using a AV connection then the video picture will be shown on the AV channel of your television.

If you are using a RF cable you need to select a Video channel on your television and tune it to the Video signal, a test picture.



Turn on the Video and TV.

Select the vacant position 68 on your TV.

Press POWER  on the Remote Control to put the Video on standby then press and hold PROG.  or  on the front of your Video for more than 4 seconds. If the test picture appear clearly on the television screen, the position 68 is your video channel.

If the test picture do not appear clearly, go to next.

Select a vacant position between 28 and 68 on your television.

Press PROG.  or  on the Video until the test picture appear clearly on the television screen.



You can also set the output frequency to OFF if there is any interference when your TV is connected to the Video with a AV cable.

# Tuning in TV stations

ACMS (Automatic Channel Memory System) automatically tunes and stores TV channels. If you want to return to ACMS after your initial set up, access it via the menu.

5

## Using ACMS

- 1 Turn on your television and your Video and select the video channel on your television.
- 2 Press **i** to access the main menu. Press **◀** or **▶** to select ACMS, and then OK.

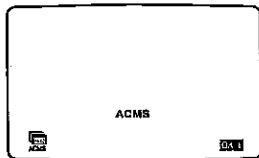

- 3 Press OK to start the automatic tuning process.
- 4 When the ACMS has finished a screen showing all the channels that have been found and the positions they have been placed in will be displayed.

- 5 Check that the channels correspond to the positions in which you want them. If they are not in the order that you would like they can be moved or deleted. See **Changing the order of the television stations** and **Deleting the television stations**.

- 6 Press **i** to store the settings.

## Changing the order of the television stations

You will find it useful to have a current television programme guide to hand during this operation.

- 1 Press **i** to access the main menu. Use **◀** or **▶** to select PR SET then press OK.
- 2 Press **i** again.
- 3 Use either the **▲** or **▼** buttons to select the programme number that you wish to move. Then press **▶**.
- 4 Press **▲** or **▼** until you reach the position you wish to store the channel in.
- 5 Press OK. The programme will move to the new position.
- 6 Press **i** to leave the menu.

To move other programs repeat the above process.

## Deleting the television stations

- 1 Press **i** to access the main menu.
- 2 Use **◀** or **▶** to select PR SET then press OK.
- 3 Press **i** then use **▲** or **▼** to select the programme number you wish to delete.
- 4 Press **◀**, after a short while the selected station will be deleted. The remaining stations are resorted automatically.
- 5 Press **i** to remove the menu. If you wish to delete further stations repeat the above process.

# Tuning and adjusting TV stations manually

You may prefer to tune your television manually. Manual tuning can be more effective if the television signal in your area is too weak for the ACMS to work properly. You can also fine tune your channels and customise the channel names.

6

## Manual tuning

- 1 Turn on your television and your Video. Select the video channel on your television and press **i** to access the main menu.
- 2 Press either **◀** or **▶** to select PR SET then press OK.
- 3 Press **i** again and the television station table will then appear.
- 4 Use the **▲** or **▼** buttons to select the programme number you want to tune then press OK.
- 5 Select the CH section (if not already selected) by using the **◀** or **▶** buttons and then press AV to select C (Standard stations) or S (Cable stations).
- 6 Use the **▲** or **▼** buttons to move through the channel numbers to find the required station.
- 7 The station can be fine tuned to improve picture quality. Select MFT (Manual Fine Tuning) using the **◀** or **▶** buttons. Use the **▲** or **▼** buttons to adjust the picture.
- 8 Select STATION by pressing **▶** you can then name your station.

- 9 Press OK to reveal the television station name list. Use the **▲** or **▼** buttons to select a station name from the list. Press OK to select it.

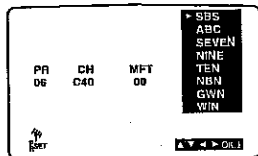

- If the name you require is not on the list see Customising station names opposite (Start from step No. 5).
- 10 To confirm the station placement press **i**.
  - 11 Press **i** again to remove the menu.
  - 12 The new station has now been stored into your Video.

If you wish to manually tune other channels you should repeat the above procedure.

To move the manually tuned channel to it's correct position see Changing the order of the television stations on page 5.

If it is necessary for you to tune all the television stations manually you may find it easier if you write the CH numbers down for each station as you find them. You can then select each channel from the main menu and type the CH numbers in directly. Each channel will then be in the correct position so there is no need to change them later.

## Customising station names

If the station name you require isn't listed you can insert one manually instead of using the templates.

- 1 Press **i** to access the main menu. Use **◀** or **▶** to select PR SET then press OK.
- 2 Press **i** again then use **▲** or **▼** to select the programme number you wish to customise station name.
- 3 Press OK.
- 4 Press **▶** to go to STATION and then press OK.
- 5 Then press **▶**, a flashing bar appears beneath the first letter.

- 6 Use **▲** or **▼** to select letters and numbers for the new station name up to a maximum of 5.
- 7 Press **◀** or **▶** to move between the characters.
- 8 Press OK.
- 9 To confirm the new position press **i**.
- 10 press **i** again to exit the menu.
- 11 The new station name is now stored in your Video.

# Operating your Video

The main functions of your Video can be operated using either the Remote Control or front control panel on the Video. Before starting, you should ensure that your television and your Video have been plugged in and switched on and that the video channel on your television is selected.

## Playing a video tape

Press **PLAY ▷**. The television screen will display **PLAY**.

## Auto tracking

Your Video will automatically adjust the tracking to give you the best picture quality. If the quality of the recording is poor, repeatedly press **▼** or **▲** on the remote control to manually adjust the tracking until any distortions have been removed.

## Stopping play

Simply press **STOP ■** to halt video play. The Video will revert to television mode.

## Picture Search

While a video cassette is playing you can search the tape forward and backward to look for a specific position on the tape.

Press **REW ◀◀** or **FF ▶▶** to make the tape play rapidly forwards or backwards. The picture will be shown at seven times normal play speed.

## Fast Forward/Rewind

To fast forward or rewind at maximum speed, the tape must not be in play mode. Press **STOP ■** then press either **◀◀ REW** for rewind or **FF ▶▶** for fast forward. Whilst you are rewinding or fast forwarding you can view the section you are passing. Press and hold (for a few seconds) either **REW ◀◀** or **FF ▶▶**. Releasing the **REW ◀◀** or **FF ▶▶** will return the Video to normal rewind or fast forward operation.

## Slow Motion Playback, Shuttle (VHR-VK910A Only)

Using the **◀** or **▶** buttons it is possible to adjust playback speed during playing back or still picture. Below is a list of what speeds are accessible and how to reach them.

- ◀ once = slow play
- ◀ twice = still
- ◀ three times = play backwards
- ◀ four times = Reverse play 3x speed
- ◀ five times = Reverse play 7x speed
- ▶ once = 2x forward play
- ▶ twice = 7x forward play

To switch off the slow motion and shuttle, press the desired function.

During slow motion and shuttle, the noise bars may appear on the picture according to the status of tape. If distortions can be seen in the picture, reduce them with **▲** or **▼**.

## Pausing a tape

Pressing **P/STILL ■** will pause play, giving you a still picture on the screen. This picture may display some interference in the form of black and white horizontal lines. This is perfectly normal and does not mean that the video tape or Video are damaged.

The tape can be paused for up to five minutes. The Video will then automatically play back a tape in order to avoid damaging the tape or your Video.

## Frame Advance (VHR-VK910A Only)

- 1 Pressing **P/STILL ■** repeatedly will advance the picture frame by frame.
- 2 You can use the **▲** or **▼** buttons to reduce any vertical movement seen on the still picture.
- 3 Press **PLAY ▷** to continue play from pause.

## Removing the Video tape

Press **EJECT ▲** to remove the video cassette from your Video. If the end of the tape is reached, your Video will automatically stop, rewind, eject the tape and place itself into Standby mode.

# Recording from television programs

There are two methods of recording, Instant Timer Recording (ITR) and Timer Recording.

For all recording methods you should ensure the television channels are tuned and stored correctly and that the clock is set to the correct time.

8

## Recording from RCA

If you wish to record directly from the AV socket at the back of your Video, connect the device you wish to record from using a AV cable and press AV to display the picture from the device.

## Long Play/Standard Play

Your Video has a Long Play (LP) feature. This means you can record twice the amount of information on each recordable video tape.

For example on a three hour (E180) tape you would be able to record six hours worth of programmes.

With Long Play picture and sound playback quality are slightly reduced from that of standard play.

Press the LP button if you wish to change to Long Play (LP), press it again to select Standard Play (SP). SP or LP will be displayed on your television screen to let you know which has been selected.

## Instant Timer Recording

ITR begins recording immediately, either for a set period of time or until the tape runs out.

- 1 Turn on your Video and television. Insert a video tape into the Video. Select the Video channel on your television.
- 2 Use the PROG. ▲ or ▼ (or CHANNEL +/-) buttons to select which programme you wish to record. The currently selected programme will be displayed on screen. You can also select the programme number using the Remote Control number buttons.
- 3 Press REC/ITR ● to begin recording. On the first press REC SP (or LP) will appear on the television screen.

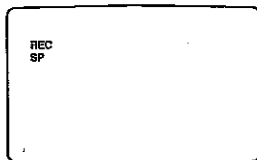

The Video will start recording. It will continue recording until the end of the tape is reached or it is manually stopped.

To set the length of time which you want to record for, press the REC/ITR ● button twice. The television screen will show 0H30. Each subsequent press of the REC/ITR ● button will increase the recording time by thirty minutes to a maximum of nine hours.

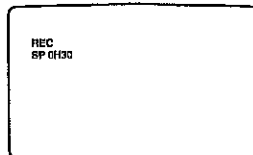

You can also interrupt recording to avoid unwanted scenes.

If you press P/STILL ■ during ITR the Video will enter the record pause mode and the set period of time is cancelled.

- 1 To pause recording press P/STILL ■.
- 2 Press P/STILL ■ again to continue recording.

Tapes can be paused for up to five minutes. REC PAUSE will be displayed on the television screen while a tape is paused. After five minutes your Video will automatically cancel recording to prevent damage to the video tape or your Video.

To view one channel whilst recording another, press TV/VCR to disappear VCR on the display panel. Using your TV remote, switch to the channel you want to watch.

## Finishing a recording

- 1 Press STOP ■.
- 2 Press EJECT ▲. EJECT will appear on the television screen. If the end of the tape is reached your Video will automatically stop recording, rewind, stop and eject the tape and place itself into Standby.



# Recording using Timer Recording

Allows you to specify a time at which the Video will start recording.

This can be done up to one month in advance with up to seven recordings being pre-programmed.

Ensure the television channels have been tuned and stored correctly and that the clock is set to the correct time.

## Timer Recording

Insert a video tape.

- 1 Press **i** for the main menu.
- 2 Use **◀** or **▶** to select REC.
- 3 Press OK. Press OK again to enter the timer record menu.

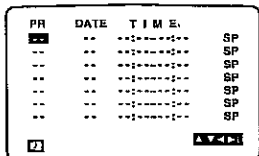

- 4 To enter the programme number that you wish to record you can scroll through the available options using the **▲** or **▼** buttons or you can enter the numbers directly. When selecting single digit numbers remember to put 0 first. If you wish to record from the VIDEO IN/AUDIO IN sockets press AV.
- 5 Press **▶** and enter the date of the programme that you wish to record. Press OK before entering a date to select one of the automated features. They are DLY (daily) to record every day except Saturday and

Sunday at the set time, or individual days e.g. MO (Monday) to record at the same time every week. Press **◀** or **▶** to select, then press OK to confirm.

- 6 Enter the time of the start and end of the programme that you wish to record. The Video uses a 24 hour clock.

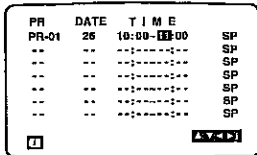

- 7 Press **▶** to select the recording speed. Use the **▲** or **▼** to move among Standard Play, Intelligent Play and Long Play. IP (Intelligent Play) determines how much tape is left and switches speed from SP to LP, if necessary, to complete recording the programme.
- 8 Check that the timer event details are correct, if they are, press **i** to save your settings. If PLEASE CHECK is displayed you have entered incorrect information.

Check the details on the television screen and reenter it. If you want to enter more Timer recordings, repeat the above process from point 3. Press **i** again to remove the menu.

- 9 Place the Video on standby by pressing the POWER **⏻** on the remote control. TIMER will appear in the Video display to show that it is set to record. The Video is now set to record at the time you have specified.

## Changing timer events

If you wish at any time to change a recording event press **▲** or **▼** to select the timer slot that you wish to change.

Press **◀** to delete or OK to edit that entry.

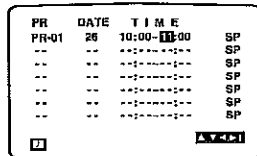

Use the **◀** or **▶** buttons to select the section you wish to change and the **▲** or **▼** buttons to change those sections.

## Protect your recordings

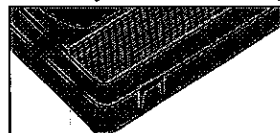

To stop a recording you have made being recorded over, break off the protection tab on the rear of the video tape. To record on a tape that has had its protection strip removed, cover the hole with adhesive tape.

## Recording tape to tape

You will need a second Video for tape to tape copying. Connect using an AV cable from AUDIO IN/VIDEO IN sockets of your Video. Select audio/video mode on the recording Video by pressing the AV on the Remote Control. To monitor the recording, connect the recording Video to your TV using the standard coaxial aerial cable.

# Advanced functions on your Video

Your Video has some advanced operations with features you may find useful.

10

## CM (Commercial Message) Skip

This enables you to skip past small sections of the video tape, such as commercial messages, television adverts or film trailers.

Press the **CM SKIP** button on the remote control, during play. Each subsequent press of the button increases the amount of the tape which is skipped by 30 seconds, up to a total of three minutes (180 seconds). After the chosen time has passed normal play will automatically resume.

## OPR (Optimum Picture Response)

This enhances the picture from the video tape by adjusting to the condition of the video tape. If you feel that the picture needs adjusting you can manually change the OPR setting. You can only set OPR when a tape is playing in the Video.

- 1 Press **⏏** to enter the main menu.
- 2 Use **◀** or **▶** to select **OPR** then press **OK**.

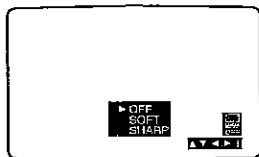

- 3 Use the **▲** or **▼** buttons to select **OFF**, **SOFT** or **SHARP**.
- 4 Press **⏏** to exit the menus.

## Colour standards

Your Video uses dual colour standards, PAL and MESECAM. During play your Video should select the Colour System automatically, however if you experience problems you may need to do it manually.

- 1 Press **⏏** to enter the main menu.
- 2 Use **◀** or **▶** to select **SYSTEM** then press **OK**.
- 3 Use **▲** or **▼** to select the colour system used in your recording.

## PAL Signals

(Playback or recording mode)

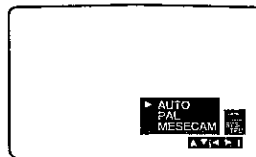

NTSC Signals (Playback mode)

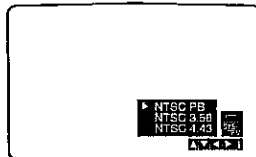

## NTSC PB:

Use when playing back a tape recorded in the NTSC system on PAL TV.

## NTSC 3.58:

Use when playing back a tape recorded in the NTSC system in 3.58 mode.

## NTSC 4.43:

Use when playing back a tape recorded in the NTSC system in 4.43 mode.

## NTSC Signals (Recording mode)

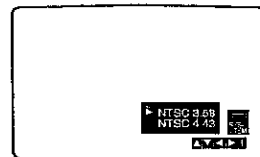

## NTSC 3.58:

Use when recording NTSC 3.58 signals.

## NTSC 4.43:

Use when recording NTSC 4.43 signals.

- 4 Press **⏏** to exit the menus.

# Advanced functions on your Video

Your Video has some advanced operations with features you may find useful.

## Setting the clock

The Video uses a 24 hour clock, so that for example 1 pm is represented as 13:00. Single digit numbers should be entered with a 0 in front for instance, 01.

- 1 Press **⏸** to enter the main menu. Use the **◀** or **▶** buttons to select TIME DATE then press OK.
- 2 Use the numbered buttons or the **▲** or **▼** on the remote control to enter the the HOURS, MINUTES, DAY, MONTH and YEAR.

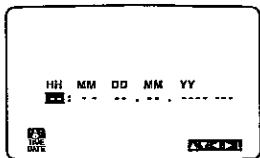

The day of the week will appear automatically once the date has been entered. If you make a mistake use **◀** or **▶** to select the item and re-enter the details.

- 3 Once you are satisfied press **⏸** to store your settings.

## On screen display (OSD)

This can be used to display the current time, tape counter, tape remaining, day, month and year, day of week, channel and operational mode of your Video on your television screen. If a recording is taking place, the on screen displays will not be recorded onto tape.

- 1 Press OK to show the OSD.

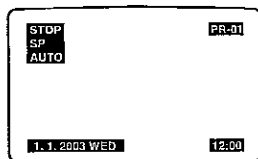

- 2 Press OK repeatedly to cycle through the display options. The tape counter and amount of tape left will appear if there is a tape loaded.
- 3 Press OK again to remove all OSD's from the television screen.

To turn off the on screen displays completely.

- 1 Press **⏸** to enter the main menu.
- 2 Select fOSD ON OFF using **◀** or **▶** then press OK.
- 3 Select OFF using **▲** or **▼**. Press **⏸** to save the setting.

## Resetting the digital tape counter

The tape counter displays the play or recording time elapsed in hours minutes and seconds. Press CLEAR to reset the counter to 0:00:00. When you press STOP **■** and press REW **◀◀**, the Video will stop at 0:00:00, the point where you reset the counter.

## Child Lock

You can turn off the buttons on the Control Panel so that your Video can only be operated using the Remote Control.

- 1 Press the C.LOCK on the Remote Control. SAFE will appear on the television screen for a few seconds.

None of the buttons on the Control Panel will work apart from EJECT **▲**.



If any other buttons on the front of the Video are pressed, SAFE will appear on the television screen for a few seconds. To unlock the Child Lock press the C.LOCK again on the Remote Control.

## Automatic power off

By pressing the POWER **⏻** while rewinding a tape the Video will turn off automatically when the tape rewind has completed.

# Advanced functions on your Video

Your Video has some advanced operations with features you may find useful.

12

## Sound settings (VHR-VK910A Only)

Your Video can record and play back stereo sound. You can select the way sound is played back.

- 1 Press **i** to access the main menu.
- 2 Select AUDIO with the **◀** or **▶** buttons.
- 3 Press **OK**.
- 4 Use the **▲** or **▼** buttons to choose between:  
STEREO  
LEFT (left channel only)  
RIGHT (right channel only)  
MONO
- 5 Press **i** to exit the menu.

## ez Operations

### ez Power Off

Press ez **POWER OFF** during play. The Video will automatically stop the tape, rewind to the beginning and eject the tape. It will then turn itself to standby.

### ez Repeat

You can select a section of the video tape to repeat twice and then resume play.

- 1 Press and hold the ez **REPEAT** for more than 4 seconds. The Video will automatically rewind for as long as the ez **REPEAT** is held.
- 2 Release the button when you want the replay to begin.
- 3 The Video will then play the selected section twice.

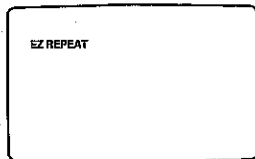

- 4 To resume normal play from any position, press **PLAY ▷** during the first repeat.

## ez (easy) Operation

If you press **PLAY ▷**, **FF ▶▶**, **REW ◀◀**, **EJECT ▲** or **REC/ITR ●** when the power of your Video is off and a tape is inserted. The power turns on automatically and then the appropriate operation will work as below.

Press	Operation
<b>PLAY ▷</b>	Power On ➔ Play back a tape
<b>FF ▶▶</b>	Power On ➔ Fast-forward a tape
<b>REW ◀◀</b>	Power On ➔ Rewind a tape
<b>EJECT ▲</b>	Eject a tape ➔ Power Off
<b>REC/ITR ●</b>	Power On ➔ Enter pause record mode. If a video tape with no safety tab is loaded, the video tape will be ejected automatically.

# Advanced functions on your Video

Your Video has some advanced operations with features you may find useful.

## Video Doctor

The Video Doctor will show the status of aspects of the Video.

- 1 Press **;** to access the main menu.
- 2 Select Dr. with the **◀** or **▶** buttons.
- 3 Press OK.

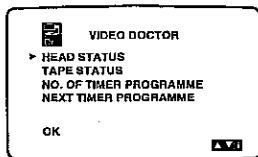

- 4 Use the **▲** or **▼** buttons to check the following features.

### HEAD STATUS

**PLEASE CLEAN:** The tape heads need cleaning.

### TAPE STATUS

**NOT RECORDABLE:** The Cassette in the Video has had its protection tabs removed, insert a tape suitable for recording.

### NO. OF TIMER PROGRAMME

2

Shows the number of timer recording programmed.

### NEXT TIMER PROGRAMME

PR-01 26 10:00-11:00 SP

Shows the current status of timer recording.

- 5 Press **;** to remove the menu from the television screen.

## Language selection

It is possible to change the language that the on screen displays are shown in. You can choose between English, Russian, Deutsch, Français and Polski.

- 1 Press **;** to display the main menu.
- 2 Select ABC using the **◀** or **▶** buttons.
- 3 Press OK to reveal the language choice screen.  
Select your desired language using the **▲** or **▼** buttons.
- 4 Press **;** to store the settings.

# Troubleshooting

If you are having trouble with your Video please check the following before calling your service centre.

14

## No picture and no sound

- Check that the Video plug has been plugged in and switched on at a mains wall socket and that the television has been plugged in and switched on.
- Check the aerial lead is undamaged and securely connected to the correct sockets in both the television and the Video.
- Check that you have tuned into a video channel on your television.
- If you are using a AV connection, check that the cable is secure and that the correct AV channel is selected on your television.

## No playback or a poor picture

- Try a different video cassette. If the problem is resolved, the problem may have been the cassette itself.
- Try using the tracking buttons ▲ or ▼ to reduce the amount of visible interference.
- If the cassette contains a recording that you have recently made from the television, the television channels may not be tuned to the Video correctly.

## TV programmes cannot be recorded

- Check the reception on your television set. If you cannot receive a picture through your aerial, the Video will be unable to record television broadcasts.
- Check the aerial lead is undamaged and securely connected to the correct sockets.
- Check that the Video has been tuned to the television programmes properly.
- Check the rear of the video cassette to see if the safety tab used to prevent recording has been removed.
- Check that the signal being received by the television is reasonable quality.

## A video tape cannot be inserted

- Check that there is not a cassette in the Video already.
- Is the video cassette the right way round? The windows should be at the top and the arrow should be pointing toward the Video.

## The Remote Control does not work

- Has the Video been plugged in and switched on?
- Check that the batteries have been inserted correctly into the Remote Control.

## The top of the video picture is unstable

- The video cassette may be damaged. Insert another video cassette and check the picture from it.
- Try adjusting the horizontal control on your television, you should consult your television user guide on how to do this.
- Check the aerial lead is undamaged and securely connected to the correct sockets.
- Ensure that the television has been correctly tuned to your Video.

## No Hi - Fi sound (VHR-VK910A Only)

- In the Audio menu check that the STEREO option has been selected.
- Check your television user guide to see if you have a stereo feature on your television.

## Autoplay does not work

- If the safety tab has not been removed from the video cassette this function will not work.

# Technical specifications

Specifications are correct at time of printing. SANYO is constantly innovating and products may change at any time without warning.

## Specifications

### General

Power	110-240V~, 50/60Hz
Power consumption	Approx. 12 Watts (Energy Saving mode: 3 Watts)
Video Head System	Double azimuth 4 heads, helical scanning (VHR-VK910A) Rotary 2 heads, helical scanning (VHR-VK310A)
Tape speed	23.39 mm/sec (SP mode) 11.69 mm/sec (LP mode)
Tape Format	Tape width 12.7mm (0.5 inch)
Max. recording time	4 hours (SP mode, E-240 Tape) 8 hours (LP mode, E-240 Tape)
Rewind time	Approx. 65 (±10) secs (E-180 tape)
Dimensions	360 x 94 x 230mm (W x H x D)
Weight	3.2 kg
Operating temperature	5° C - 35° C
Operating humidity	Less than 80%
Timer	24 hours display type

### Video

Television system	CCIR standard (625 lines, 50 fields) PAL(B/G, D/K)/SECAM(B/G, D/K) colour signal
Recording format	PAL/MESECAM/NTSC 3.58/NTSC 4.43
RF reception	PAL B/G, SECAM B/G
RF OUT	PAL G
Input level	VIDEO IN (RCA) 1.0 Vp-p, 75 Ohm unbalanced
Output level	VIDEO OUT (RCA) 1.0 Vp-p, 75 Ohm unbalanced
Signal to noise ratio	More than 43 dBm
RF modulator	UHF channel 28-68 (Adjustable)

### Audio

Input level	AUDIO IN (RCA) - 6.0 dBm, more than 47 kohms
Output level	AUDIO OUT (RCA) - 6.0 dBm, less than 1 kohms
Track	Mono track & Hi - Fi Track
Frequency response	Normal : 100 Hz - 10 kHz (-6/+3 dBm) Hi - Fi : 20 Hz - 20 kHz (-3/+3 dBm)
Signal to noise ratio	Hi-Fi : More than 70 dB (JIS A filter)
Dynamic range	Hi-Fi : More than 85 dB (JIS A filter)

P/N: 3834RP0090W

**SANYO**

---

SANYO Electric Co., Ltd.