

ASW 33AP

PORTABLE COMPACT AUTOMATIC WASHER

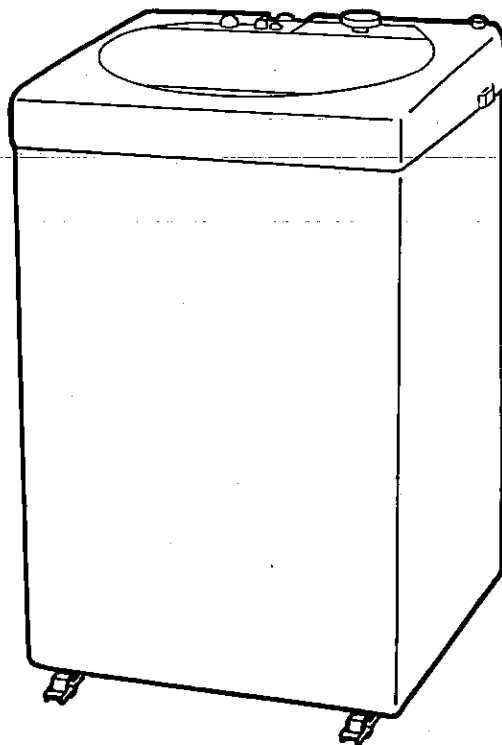

ATTENTION

For your protection in the event of theft or loss of this product; please fill in the information requested below:

Model No. _____

Serial No. _____

(Located on the back of the unit)

Date of Purchase _____

Purchased Price _____

Where Purchased _____

IMPORTANT SAFETY INSTRUCTIONS

WARNING — To reduce the risk of fire, electric shock, or injury to persons when using your appliance, follow basic precautions, including the following:

1. Read all instructions before using the appliance.
2. Do not wash articles that have been previously cleaned in, washed in, soaked in, or spotted with gasoline, dry-cleaning solvents, other flammable or explosive substances as they give off vapors that could ignite or explode.
Do not add these substances to the wash water.
Do not use these substances around the appliance during operation.
3. Do not allow children to play on or in the appliance. Close supervision of children is necessary when the appliance is used near children.
4. Before the appliance is removed from service or discarded, remove the washer lid to the washing compartment.
5. Do not reach into the appliance if the tub, pulsator, or drum is moving.
6. Do not install or store this appliance where it will be exposed to the weather.
7. Do not tamper with controls.
8. Do not repair or replace any part of the appliance or attempt any servicing unless specifically recommended in the user-maintenance instructions.
9. Under certain conditions, hydrogen gas may be produced in a hot water system that has not been used for 2 weeks or more. **HYDROGEN GAS IS EXPLOSIVE.**
If the hot water system has not been used for such a period, before using a washing machine, turn on all hot water faucets in the house and let the water flow from each for several minutes. This will release any accumulated hydrogen gas. As the gas is flammable, do not smoke or use an open flame during this time.
10. Do not use hot water that exceeds 60°C in temperature.
11. To prevent movement of the washer during spinning, be sure to lock casters.

SAVE THESE INSTRUCTIONS

GROUNDING INSTRUCTIONS

This appliance must be grounded.

In the event of malfunction or breakdown, grounding will reduce the risk of electric shock by providing a path of least resistance for electric current.

This appliance is equipped with a cord having an equipment-grounding conductor and a grounding plug.

The plug must be plugged into an appropriate outlet that is properly installed and grounded in accordance with all local codes and ordinances.

DANGER — Improper connection of the equipment-grounding conductor can result in a risk of electric shock.

Check with a qualified electrician or serviceman if you are in doubt as to whether the appliance is properly grounded.

Do not modify the plug provided with the appliance — if it will not fit the outlet, have a proper outlet installed by a qualified electrician.

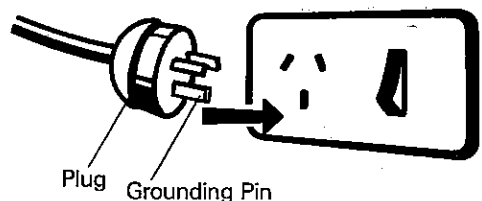

NAMES OF PARTS

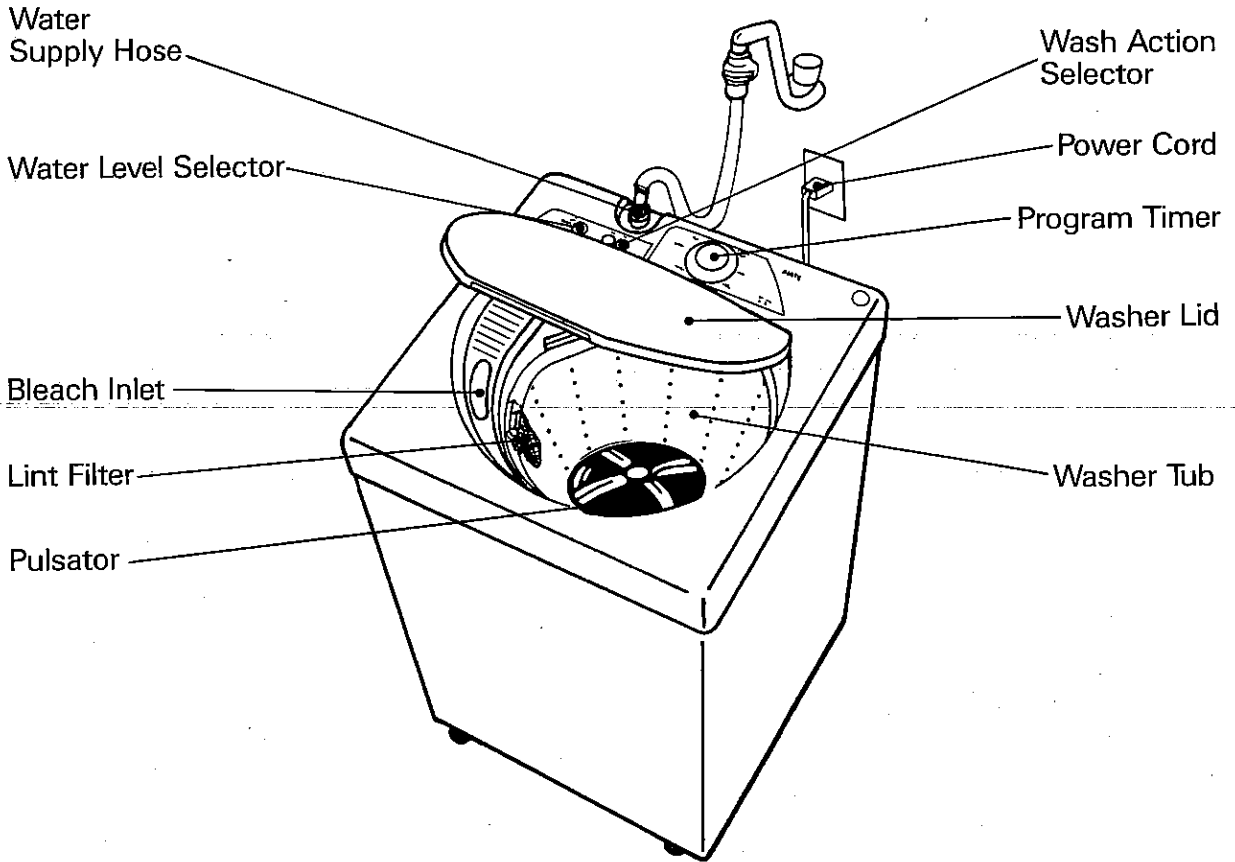

ACCESSORIES

Caster-Front (2 each)



Drain Hose



Hose Hanger



Water Supply Hose



Roller (2 each)



Screw (2 each)



Caster Wrench



Goose Neck



Hose Band (2 each)



INSTALLATION INSTRUCTIONS

1. Location

- (1) Choose a dry spot, out of sunlight.
- (2) Install on a firm and level surface.

2. Mounting of Casters

- (1) Lay down the washer carefully on the floor. To avoid any damage to surface of washer, place a soft cloth or cushion on the floor.
- (2) Casters are packed in the accessory bag with attachment parts.
- (3) **FRONT** Install front casters by screwing into threaded holes, tighten with caster wrench.
- (4) **REAR** Slip one end of rear caster into the slit and then secure by screw.

NOTE: Front casters have stopper levers, be sure to lock them before using.

3. Install Water Supply Hose

- (1) Attach the elbow end of the water supply hose to the water inlet of the washer.
- (2) Attach the other end of the water supply hose to a tap.

4. Install Drain Hose

- (1) Slip hose bands onto both ends of the drain hose.
- (2) Attach the goose neck to the free end of the drain hose and secure it with a hose band. (Hook it over a sink or tub for drainage.)
- (3) Attach the other end to the drain outlet in the rear of the washer and secure it with a hose band.

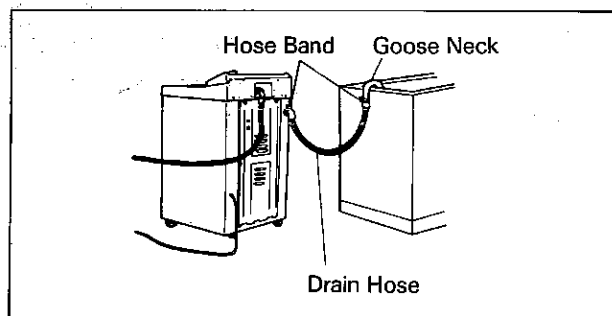
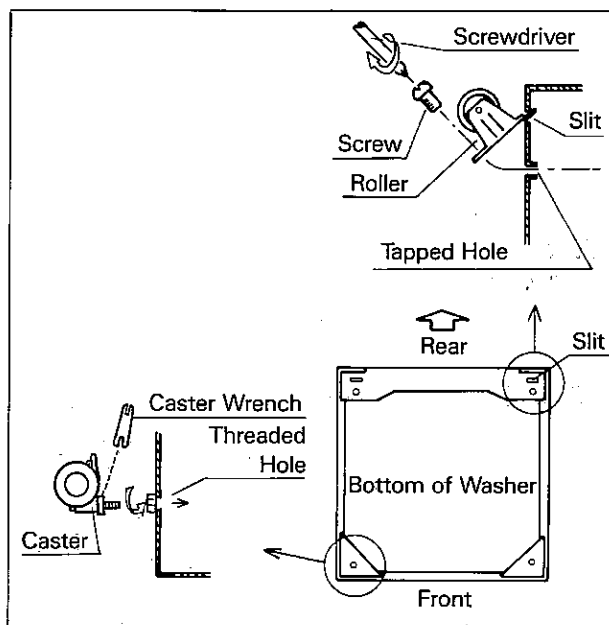

OPERATING INSTRUCTIONS

WARNING — To reduce the risk of fire, electric shock, or injury to persons, read the **IMPORTANT SAFETY INSTRUCTIONS** before operating this appliance.

Before Operation

1. Push the 3-pin power plug firmly into a correctly grounded AC outlet.

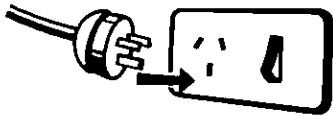

2. Attach water hose to sink faucet and extend drain hose into sink. Turn water on. Water temperature is controlled by adjusting sink faucet controls.

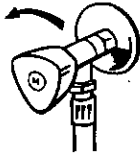

3. Place detergent and clothes into the washer.

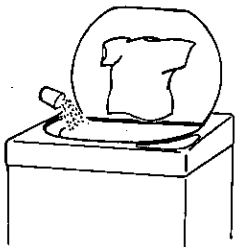

4. Set the WATER LEVEL selector for load size.

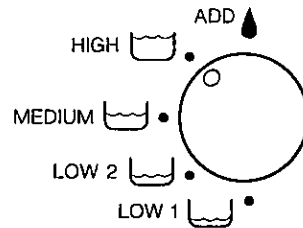

WATER LEVEL

5. Depress the desired WASH ACTION button.



WASH ACTION

6. Set the program timer and pull the knob to begin operation.

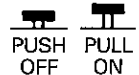
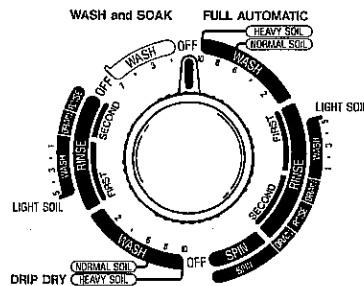

After Operation

1. Push the program timer knob in to turn off the washer.
The washer can be turned off at any time during operation.
2. Turn the faucet off and, if necessary, disconnect the water supply hose.
3. Unplug the power cord.

HOW TO USE (1)

1. Program Timer

- Pull the knob in the center of the timer dial and the washer will begin operation. Push it in to stop.
- The washing program for automatic operation is described in the table below:

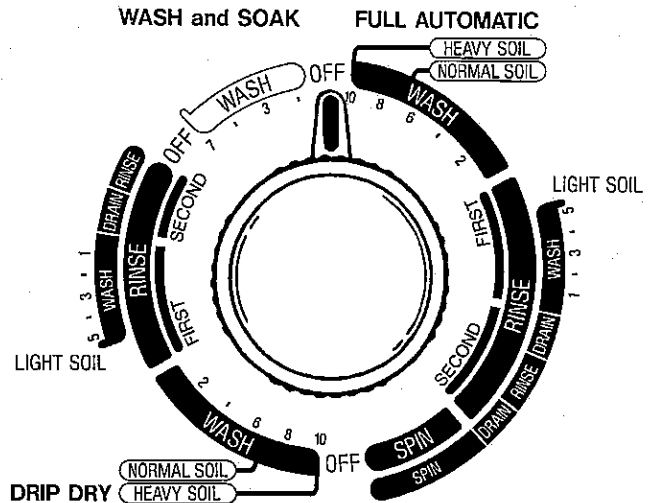

Cycle Fabrics Operation	FULL AUTOMATIC		DRIP DRY	
	Heavy to Normal Soilage	Light Soilage (Synthetic Fiber)	Heavy to Normal Soilage	Light Soilage (Wool, Delicate)
Wash	6 to 10 min.	—	6 to 10 min.	—
Drain	2 min.	—	2 min.	—
Rinse/Wash	5 min.	5 min.	5 min.	5 min.
Drain	2 min.	2 min.	2 min.	2 min.
Rinse	2 min.	2 min.	2 min.	2 min.
Drain	2 min.	2 min.	—	—
Spin-dry	6 min.	6 min.	—	—

- WASH** Set the program timer according to the fabric and the degree of soiliness. The timer can be readjusted during operation.

Clothing	Wash Action Selector	Washing Time
Preshrunk Wool and Delicate Fabrics	GENTLE	4 to 6 min.
Synthetic Fiber	NORMAL	6 to 8 min.
Cotton, Linen	NORMAL	6 to 8 min.
Heavily Soiled Cotton or Linen	NORMAL	8 to 10 min.

- WASH and SOAK** This cycle is also automatic. Two loads of laundry can be washed without changing water and detergent. At the end of the first WASH and SOAK cycle, take out the first load and put in the second load. Then advance the timer dial to the FULL AUTOMATIC cycle and pull the knob.
- PRE-WASHING** For very heavily soiled laundry, use the WASH and SOAK cycle which takes about 3 minutes. Then turn the knob until it points to the DRAIN section to drain the water. Note that silk, wool, synthetic fibers and light clothing do not require pre-washing.
- DRAIN or SPIN-DRY** Turn the knob until it points to the DRAIN or SPIN section of the FULL AUTOMATIC cycle.

2. Water Level Selector

Choose the water level in accordance with the type and amount of laundry being done.

LOW 1 is for loads less than $\frac{1}{3}$ full of clothes.

LOW 2 is for loads between $\frac{1}{3}$ and $\frac{1}{2}$ full.

MEDIUM is for loads between $\frac{1}{2}$ and $\frac{2}{3}$ full.

HIGH is for loads over $\frac{2}{3}$ full.

Use the following chart.

Relationship between water level, volume of laundry and amount of detergent and bleach.

WATER LEVEL (Water Volume)		LOW 1 (26ℓ)	LOW 2 (32ℓ)	MEDIUM (37ℓ)	HIGH (42ℓ)
DETERGENT (High Suds Powder Type)		38g	46g	53g	60g
BLEACH (Liquid Type)		60 ml	75 ml	85 ml	95 ml
CLOTHES	Sheets	—	—	—	1
	Tablecloths	—	—	1	1
	Shirts	1	2	2	2
	Bath towels	1	1	2	3
	T-shirts	1	1	2	1
	Pillow cases	1	2	2	2
	Shorts	1	2	3	2
	Wash cloths	2	4	4	5
	Handkerchiefs	0	4	4	5

NOTES

1. Use recommended amount of detergent for your load as shown in chart.
2. If the recommended amount of detergent produces too much suds, switch to a low suds detergent, and follow instructions on package.
3. For other detergents — Low and normal suds, powders, liquids, non-phosphate powders, follow recommendations on package.
4. For LIGHT SOIL Cycle, use half the amount of detergent recommended in the chart.
5. Using too little detergent is a common case of laundry problems.
Always measure detergent in a standard measuring cup.
6. Preshrunk wool with "hand washing" label attached and other delicate fabrics should be placed in a nylon net for extra protection.

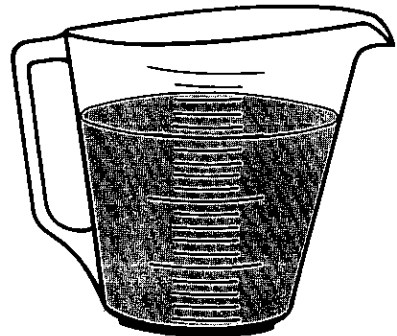

Standard Measuring Cup

HOW TO USE (2)

3. Bleach Inlet

- Pour bleach into the washer during wash cycle through the bleach inlet after it has been properly diluted. Use the chart on page 6 for proper quantities.
- Do not use bleach for colored fabrics.
- Wash the bleach inlet with water after using it.
- Do not leave water with bleach in the washer tub for an extended period of time. Drain after use.

5. Drain Hose

The built-in pump is capable of discharging water to a maximum height of 1.2 meters and minimum height of 0.7 meters. This must be within 1.5 meters of either side of the location of the washer.

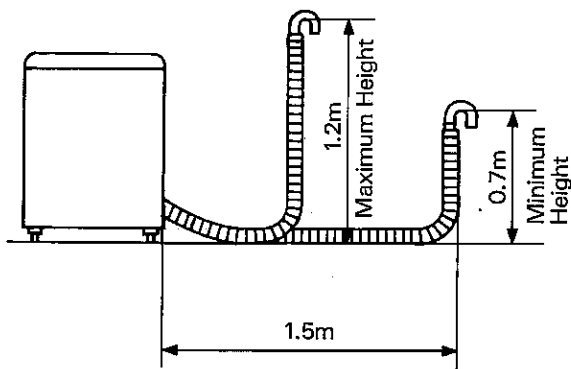

4. Lint Filter

a) Removal

To remove the lint filter, hold the ring section of the filter and pull forward.

b) Cleaning

Pull out the inside of the filter net and rinse in water.

c) Replacement

Place the ring section of the filter on both filter attachment parts on the balancer and push the ring in firmly until both sides click. Pull the ring slightly to make sure that it is securely attached.

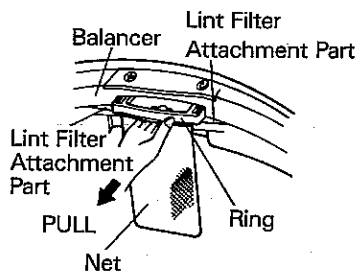

CAUTION

- Clean the lint filter each time you wash.
- Laundry that can damage the net of the lint filter should be placed in a nylon net washing bag.
- If the lint filter is damaged, a new one can be purchased at your dealer.

CARE AND MAINTENANCE

- Occasionally remove the water supply hose from the water inlet and clean the metal filter of the water inlet.

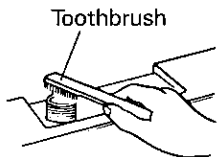

- Wipe the washer clean and dry with a soft cloth. Do not use brushes, polishing powder, benzene, or other volatiles to clean the washer.

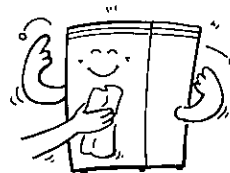

- This washer incorporates a large number of plastic parts, so be sure not to bring any type of flame near it, or put lit cigarettes or volatile materials on top of it. Also, make sure to keep the washer at least one meter away from heat sources.

- Do not install the unit in a place where it will be exposed to moisture or rain, for example, in a bathroom or outdoors.

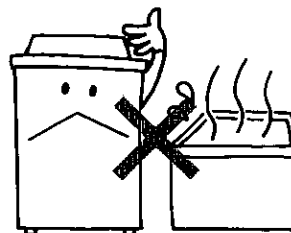
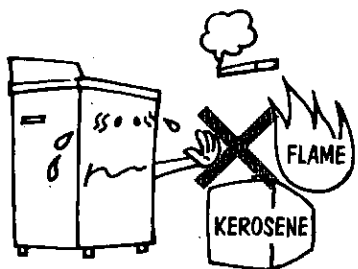

- Be sure not to splash or pour water on the control panel where the timer and switches are located.

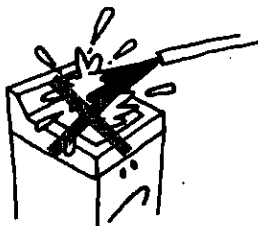

- Be careful during the spin-dry cycle. Never put your hands into the washer/spin-dryer tub until it comes to a complete stop, as it can cause injury.

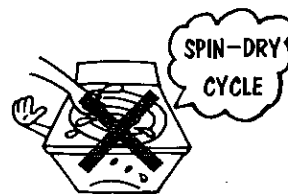

SERVICE

If the washer fails to operate properly, check the following points before you call your dealer or service center.

1. When the motor does not start:
 - Has the timer dial been pulled out to activate?
 - Is the unit securely plugged into a power outlet?
 - If the washer stops during Spin cycle, refer to point 4.
2. When operation is excessively noisy:
 - Are clothes collected on one side of the tub?
 - Is the washer installed on a firm, level area?

3. When the drain pump does not drain out:

- Check the drain hose for blockage.
4. When the washer stops during the Spin cycle:
- Open the lid and rearrange the clothes evenly around the tub.

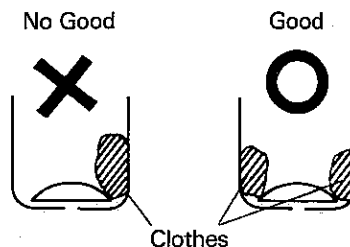

SPECIFICATIONS

Overall Dimensions	540(W) × 570(D) × 940(H) mm
Weight	Approx. 29 kg
Power Source	50 Hz, 240V
Power Consumption	Wash/Spin Motor 360W Pump Motor 115W
Water Levels	LOW 1 : 26 litres LOW 2 : 32 litres MEDIUM: 37 litres HIGH : 42 litres
Pulsator	700 — 760 rpm
Spin-Dryer	800 — 830 rpm
Spin-Drying Method	Centrifugal spin-drying
Service Water Pressure	Below 750 kPa (110 p.s.i)

**CORD REPLACEMENT: (IN SERVICE) RETURN TO SUPPLIER
FOR REPAIR AND FOR REPLACEMENT OF FLEXIBLE CORD.**

MEMO

SANYO

SANYO Electric Co., Ltd.
OSAKA, JAPAN

CODE NO. 301-6-411S-16000

617-123-7757

Printed in Singapore