

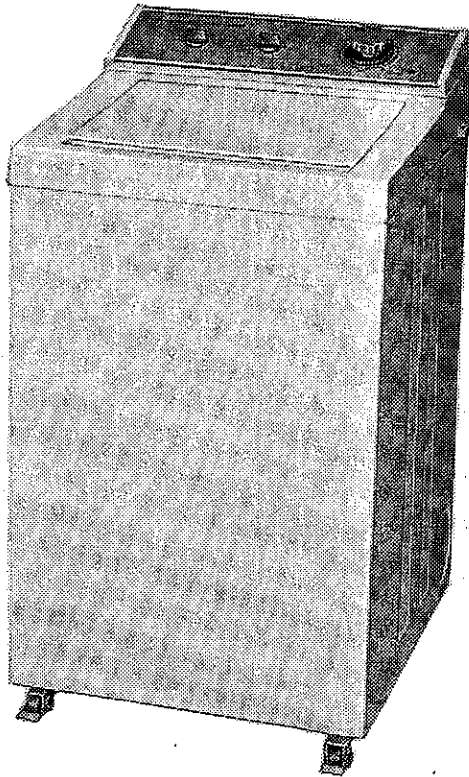

SANYO

ASW 960P



SANYO AUTOMATIC WASHER OPERATING INSTRUCTIONS

(S.A.)

Thank you for your purchase of the Sanyo Automatic Washer.
Please read these instructions carefully before using.

NAME OF PARTS IDENTIFICATION

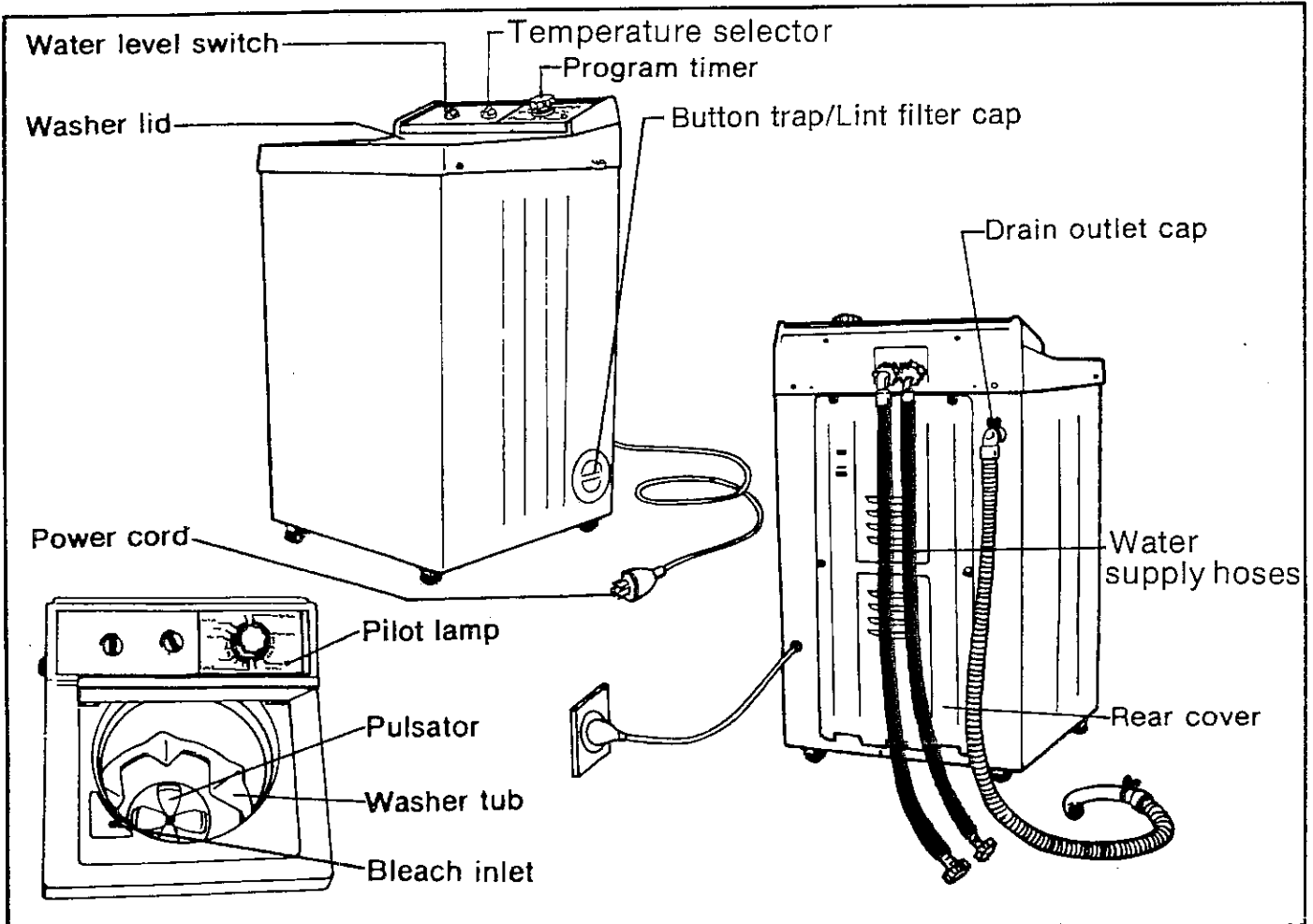

Accessories

Caster-Front (2-each)

Rollor (2-each)

Screw (2-each)

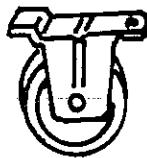
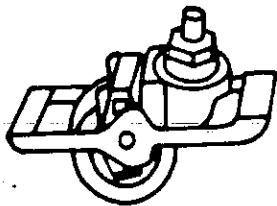

Hose band (2 each)

Water supply hose (2-each)

Hose hanger

Goose neck

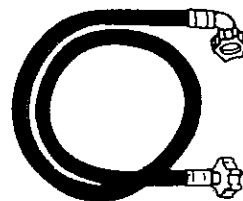
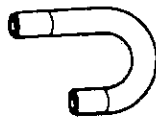

Cap nut

Tray

Drain hose



INSTALLATION

1. Place

1. Make sure the place you select provides easy access to water, electrical power and drainage.
2. Choose a dry spot.
3. Do not install the washer outdoors in regions where the temperature drops below the freezing point. If this cannot be avoided, drain the washer completely after use.
4. Install the washer on a firm, level surface.
5. To attach the hose to the washer, simply tighten the cap nut securely to the water supply valve.

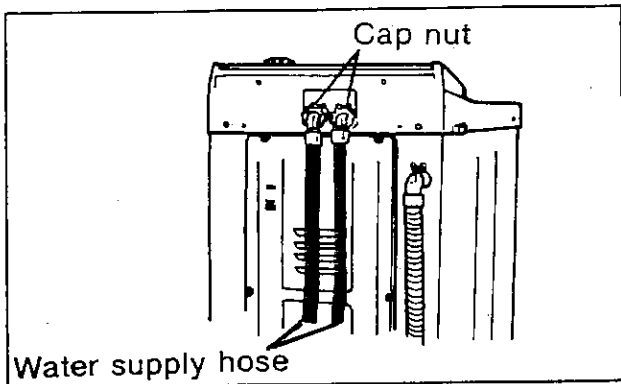

2. Drain Hose

1. Slip hose bands onto both ends of the drain hose.
2. Attach the goose neck to the free end of the drain hose and secure it with a hose band. (Hook it over a sink or tub for drainage).
3. Attach the other end to the drain outlet in the rear of the washer and secure it with a hose band.

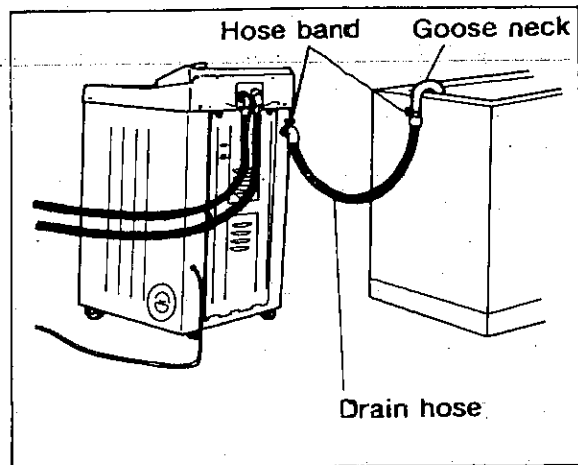

3. Power Cord

1. This model is designed to operate on ordinary house current (local voltage). Plug the power cord into the nearest outlet.
2. Do not overload the outlet with more than one appliance.

WASHING

1. Before Operation

- a) Check the water supply and drain hoses and the power cord.
- b) Open the faucets that are connected to the water supply hoses. (Hot water 60 to 70°C can be used.) If the water level switch is set at LOW, 28 liters are required. MEDIUM takes 32 liters and HIGH takes 36 liters.
- c) Sort out the laundry according to fabric. Silk and other delicate fabrics should be placed in a nylon net for extra protection.
- d) Put in the proper amount of detergent. Apply it directly to collars, cuffs and other areas that are heavily soiled. Low-foam detergent is recommended.
- e) Adjust the water level switch.
- f) Set the program timer and pull the knob to begin operation.
- g) If bleach is to be used, pour in through the bleach inlet during operation.

2. After Operation

- a) Push the program timer knob to turn off the washer. The washer can be turned off at any time during operation.
- b) Close the faucets and, if necessary, disconnect the water supply hoses.
- c) Unplug the power cord.
- d) Clean lint filter after every 3 or 4 washers, more frequently if washing fluffy items e.g. nappies.
- e) Maintenance of the lint filter is the user's responsibility. Service resulting from non compliance with the lint filter cleaning procedure is not covered by warranty.

HOW TO USE

1. Program Timer

- a) Pull the knob in the center of the timer dial and the washer will start operation. Push it to stop.
- b) The washing program for automatic operation is described in the table below:

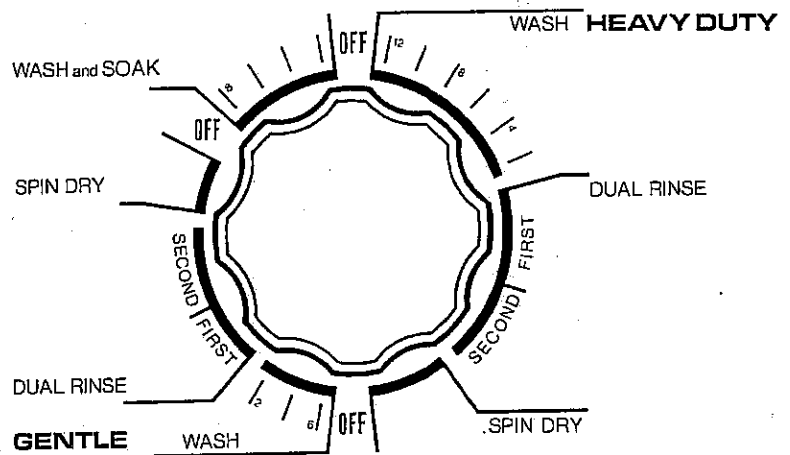

Cycle Fabrics		HEAVY DUTY		GENTLE	
		Heavy to medium soilage		Light soilage (synthetic fiber, wool)	
WASH		12 min.		6 min.	
RINSE	FIRST	Drain	2 min.	Drain	2 min.
		Rinse	4 min.	Rinse	2 min.
	SECOND	Drain	2 min.	Drain	2 min.
		Rinse	2 min.	Rinse	2 min.
	Drain	2 min.	Drain	2 min.	
SPIN DRY		6 min.		4 min.	

- c) WASH. Set the program timer according to the fabric and the degree of soilage. The time can be readjusted during operation.

Clothing	Washing time
Silk, wool, synthetic fiber	4—6 min.
Cotton, linen	6—10 min.
Heavily soiled cotton or linen	10—12 min.

d) WASH and SOAK. This cycle is also automatic. Two loads of laundry can be washed without changing water and detergent. At the end of the first WASH and SOAK cycle, take out the first load and put in the second load. Then advance the timer dial to the HEAVY DUTY cycle and pull the knob.

e) PRE-WASHING. For very heavily soiled laundry, use the WASH and SOAK cycle which takes about 3

minutes. Then turn the knob until it points to the first segment of the RINSE section to drain the water. Note that silk, wool, synthetic fibers and light clothing do not require pre-washing.

f) DRAIN or SPIN DRY. Turn the knob until it points to the SPIN DRY section of the HEAVY DUTY cycle.

2. Water Level Switch

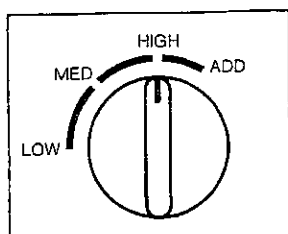

a) Choose the water level in accordance with the type of laundry and the amount. Use the following chart:

Clothing	Fabric	Low water level	Medium water level	High water level
Shirts	Cotton	6	8	11
Shirts	Synthetic	7	9	12
Children's wear	Cotton	16	20	27
Sheets	Cotton	3	4	5
Aprons	Cotton	5	6	8
Undershirts	Cotton	11	14	18
Pajamas (top and bottom)	Cotton	3	4	5
Winter shirts	Cotton	4	5	7

Note: This chart indicates standard washing capacities. For the best results, limit the load to about 80% of the figures given above.

- b) Low is for a load capacity of up to 1.5kg. MEDIUM is for loads from 1.5kg to 2.0kg. HIGH is for loads over 2.0kg.
- c) The water level switch can also be used to replenish water in the washer tub. Turn to ADD and additional water will be supplied. Turn it back to its original position to stop water supply.
- d) The amount of detergent is determined according to soilage and water level. Use the following chart.

Water level	Detergent
HIGH	40~50g
MEDIUM	35~45g
LOW	30~40g

3. Temperature Selector Switch

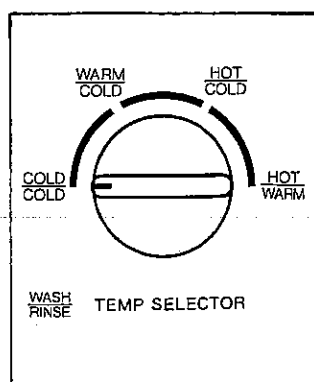

- a) Each position of the temperature selector gives a water temperature selection for wash fill and deep rinse fill.

- b) If hot and cold water is available you may select any one of the WASH/RINSE temperature combinations, but if only cold water is available, select COLD/COLD.

Be sure not to set either selector halfway between marked positions of a malfunction may result. Be sure to select the position precisely.

4. Bleach inlet

- a) Pour bleach into the washer through the bleach inlet after it has been properly diluted. Use the following chart for proper quantities:

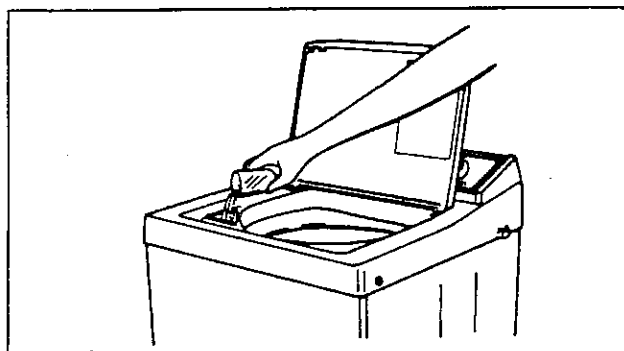

Water level switch	HIGH	MEDIUM	LOW
Bleach (undiluted)	70 cc	60 cc	50 cc

- b) Do not use bleach for coloured fabrics.
- c) Wash the bleach inlet with water after using it.
- d) Do not leave water with bleach in the washer tub for a long period of time. Drain after use.

CARE AND MAINTENANCE

1. Wipe your washer clean and dry with a soft cloth. Do not use brushes or polishing powder.
2. If the temperature is likely to drop below the freezing point, detach the water supply hose and drain all water from the washer.
3. If water does freeze in the washer, pour hot water (about 60°C) into the tub until the pulsator is submerged. Do not switch on the power until the pulsator can be turned by hand.

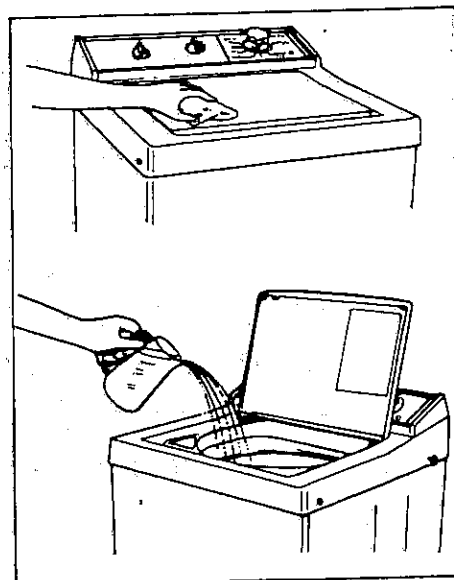

SPECIFICATIONS

Power source	AC: 240V 50Hz	
Motors	Washing: 360W input	
	Draining: 115W input	
Water levels	LOW	: 28 ℓ
	MEDIUM	: 32 ℓ
	HIGH	: 36 ℓ
Water temperature	<u>WASH</u>	<u>RINSE</u>
	HOT	WARM
	HOT	COLD
	WARM	COLD
	COLD	COLD
Program timer	64-minute electric timer	
Pulsator	700—730 rpm	
Spin dryer	800—830 rpm	
Spin drying method	Centrifugal spin drying	
Service water pressure	Below 5kg/cm ²	
Dimensions	865(H) × 515(W) × 540(D) mm	
Weight	30 kg	

A FEW THINGS TO REMEMBER

1. Keep the washer lid closed during operation. If the lid is left open, the spin dryer drum will not rotate.
2. Never put your hand into the dryer drum until it has come to a complete stop.
3. Keep the water faucets open throughout the entire washing process.
4. Do not splash water on the switch panel.
5. Keep the washer away from heat sources. Do not put lit cigarettes or inflammable liquids on it.
6. To allow good air circulation, install the washer at least 5cm from the wall.
7. To prevent water from spouting out of the water supply hose when disconnecting it from the water faucet, set the temp. selector to WARM/COLD then turn the timer to WASH and pull the timer knob in for a few seconds. This will drain water from the hose.
8. If there is any danger of freezing:
 - a) Turn off faucets, set the program timer to WASH and pull out the knob. (When disconnecting the water supply hoses to reduce water pressure be careful to avoid spouting.)
 - b) After disconnecting the water supply hoses, turn it down and drain it completely. It will take about 1 minute to drain.
 - c) Set the program timer to the final SPIN in the HEAVY DUTY cycle, pull out the knob and drain the water completely from the tub.
 - d) Pull out the stopper of the drain outlet and drain any remaining water in the pump.
9. To clean lint filter or button trap:
 - a) First, place the Tray, included, in front of the button trap cap.
 - b) Pull out the rubber cap and pre-drain.
 - c) Remove the entire button trap cap by turning it to the left.
 - d) Remove the filter and clean it.
 - e) Replace all parts.

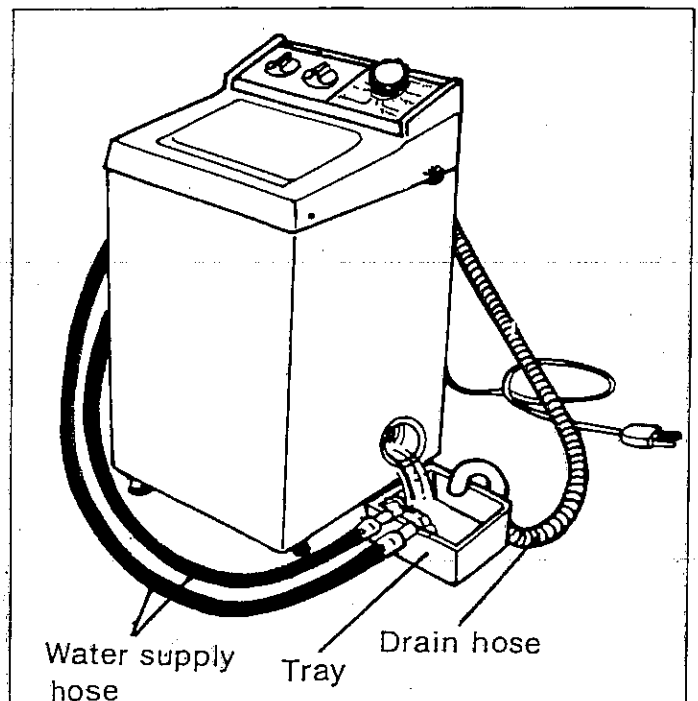

SOME USEFUL INFORMATION

1. The washer will not operate until the water has risen to the pre-set level.

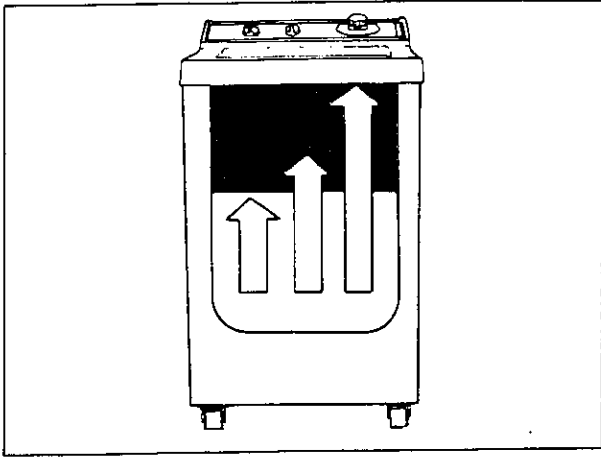

2. A built-in safety switch cuts off power and stops spin-drying if the drum begins to vibrate excessively. To correct this, open the washer lid, re-load the laundry evenly and then close the lid again. Spin-drying will continue.
3. Dirt or lint may collect underneath the pulsator. Clean out occasionally by:

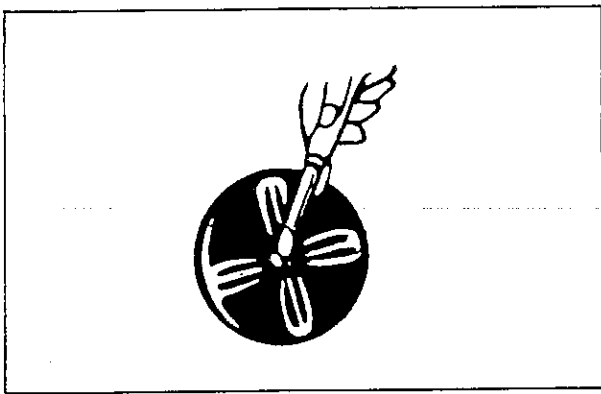

- a) turning the pulsator screw counterclockwise with a screwdriver,
- b) lifting out the pulsator, and
- c) wiping clean the bottom of the wash tub.

4. If water supply pressure runs low, i.e., it takes more than 4 minutes to reach the LOW water level, disconnect the water supply hose. Then disassemble the strainer, ring and 2 washers in the water inlet. Reassemble them after cleaning or replacing the strainer, and re-attach the water supply hose. When the strainer is clean, water supply pressure increases by 20 to 30%.
5. The spin dryer does not rotate unless the lid is closed. To stop the drum, open the lid.
6. The built-in drain pump is capable of discharging water to a maximum height of 1.2 meters. If the drain hose is more than 3.6 meters long, the dischargeable height is reduced to 0.8 meters. Refer to the following diagram for proper drainage:

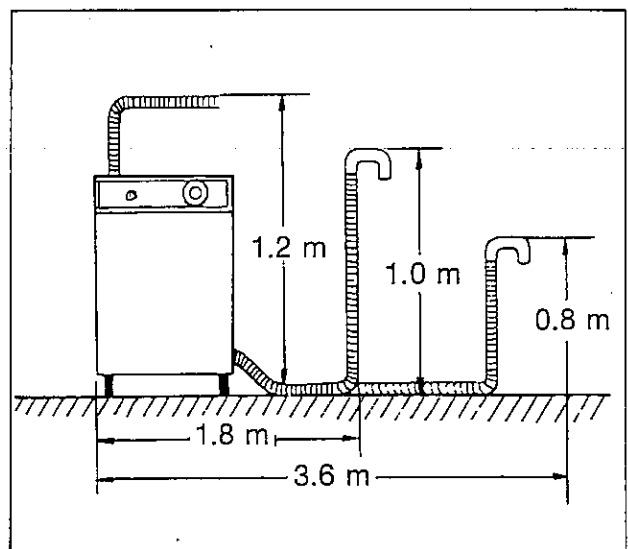

IN CASE OF TROUBLE

1. If the washer fails to operate properly after the completion of all necessary preparations, check the following:

A) When the washer does not operate at all, see if

- 1) the knob of the program timer has been pulled out,
- 2) the power cord is properly connected,
- 3) a fuse is blown or a circuit breaker is open, or
- 4) the washer lid is open (for spin-drying).

B) When the washer operates but no water is supplied, see if

- 1) the faucets are open and water is flowing,
- 2) water is frozen in the water supply hoses,
- 3) the strainer in the water supply valves are clogged, or
- 4) the washer lid is open (for spin-drying).

If troubles other than those mentioned above occur, contact the store where you purchased your washer or a Sanyo Service Center in your area.

2. If there is a power failure during the washing operation, leave the washer switched on. It will continue operation when power is restored.

3. If the water supply is cut off during the washing operation, switch off the power and disconnect the water supply hoses from the faucet. When water supply is resumed, it is often dirty and rust-coloured. Run the water until it becomes clean again, and then re-connect the supply hose.

4. Switch off the power if there are noticeable fluctuations in voltage (e.g., fluorescent lights go on and off).

5. A decrease in water pressure will mean that the washing cycle time takes longer. This does not denote a malfunction.

6. Rusty water can stain the laundry. In some areas it is necessary to detach the water supply hose before operation and let the water run until it becomes clean.

7. If washer does not pump out, check and if necessary clean lint filter.



SANYO

SANYO ELECTRIC CO., LTD
OSAKA, JAPAN

301-6-411S-83900
SI Printed in Japan