

**MIKROWELLENGERAET FUER DIE GASTRONOMIE
BEDIENUNGSANLEITUNG**

**COMMERCIAL USE MICROWAVE OVEN OPERATING
INSTRUCTIONS**

**FOUR PROFESSIONNEL A MICRO-ONDES
MODE D'EMPLOI**

**MAGNETRONOVEN VOOR COMMERCIEEL GEBRUIK
GEBRUIKSAANWIJZING**

**FORNO A MICROONDE PROFESSIONALE
ISTRUZIONI D'USO**

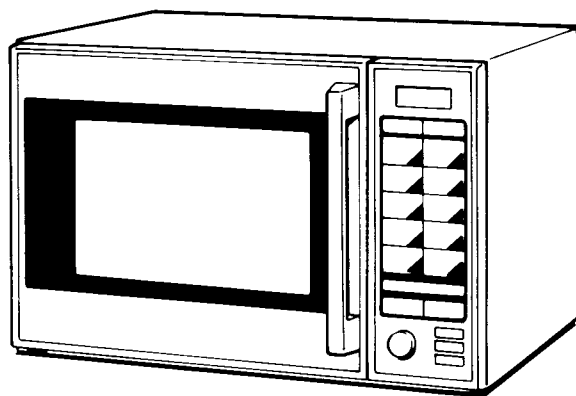

EM-C2000

NAME AND FUNCTION OF PARTS

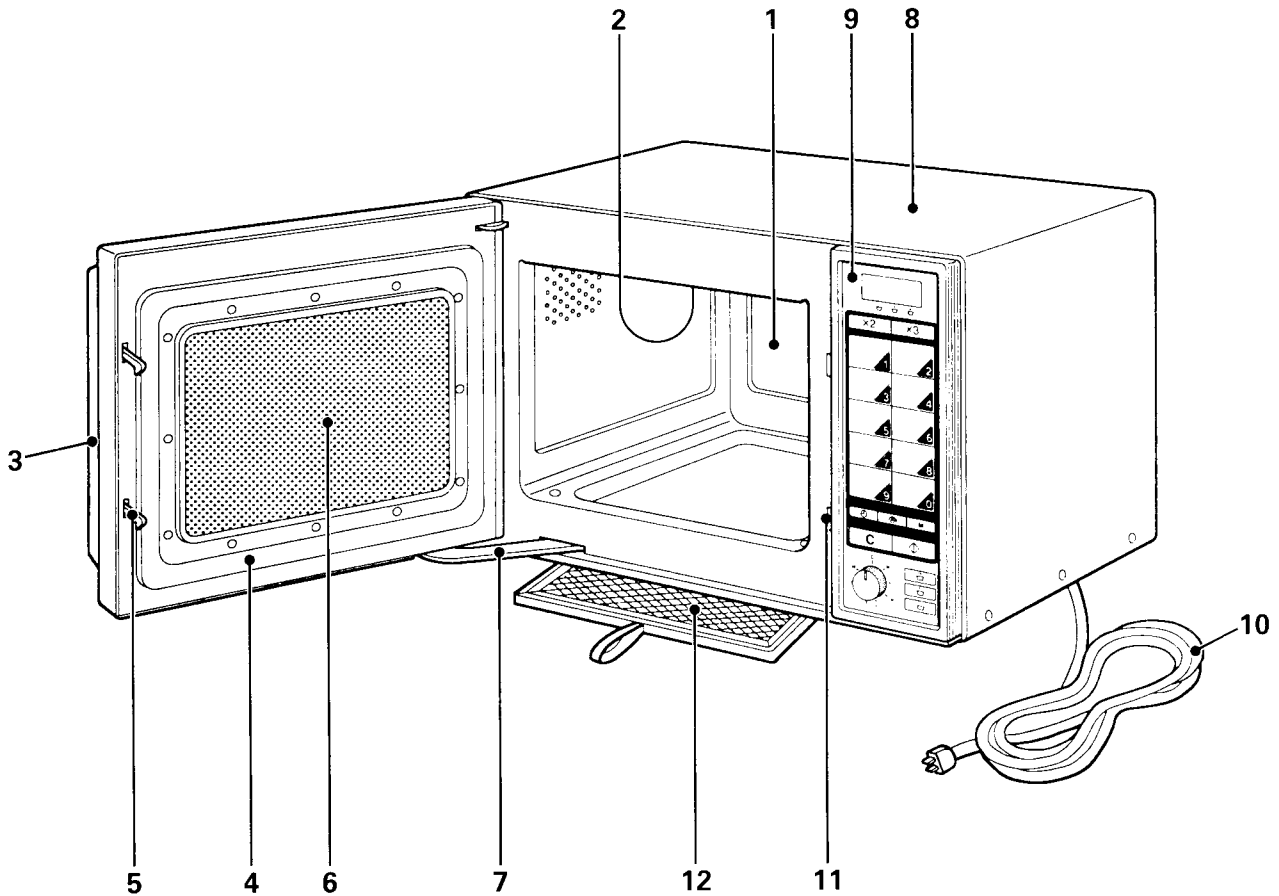

1.Oven Cavity

Place food in this space to cook. Wipe the cavity clean each time the oven is used.

2.Stirrer Shield

Clean with care.

3.Door Handle

When the door handle is gripped, a built-in switch turns off the power before the door is opened.

4.Door

5.Door Latch

6.Glass Shielded Viewing Window

The progress of cooking can be observed while oven is operating.

7.Door Arm

Prevents door swinging back.

8.Cabinet

9.Control Panel

10.Mains Lead

11.Safety Interlock System

With built-in safety interlock.

12.Air Filter

Clean with care.

Note: When opening door, be sure to open fully.

CONTROL PANEL

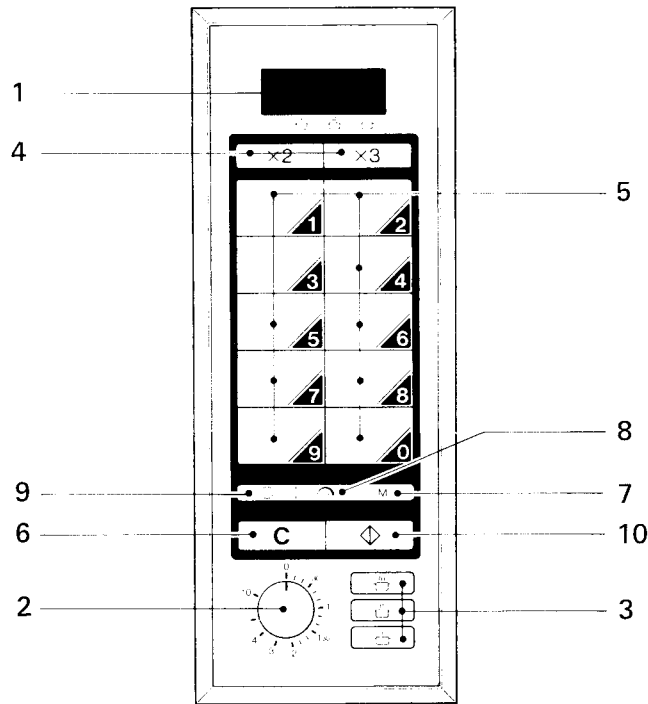

1. Digital Timer

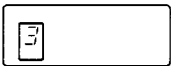

- Indicates when unit is operating and memory has been set. Programme is displayed by NO.

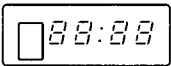

- Displays remaining cooking time.



- Displays cooking power levels.

2. Timer (Manual and Repeat)

3. Power Select Buttons (Manual cooking)

	High	1800W
	Medium	900W
	Low	360W

4. Multiple Quantity Selection Key

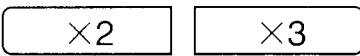

- For tailoring cooking to double or triple-quantity. These keys to be used in conjunction with the Programme key.

5. Programme Selection Keys



- The unit is ready to begin operation as soon as the heating time has been programmed, using these ten keys (numbered 1 to 0). The time selected will be displayed, and "count down" after the process is begun.



- For determining power output and cooking time during programming.

6. Clear Key



- For cancelling setting, interrupting the setting process when a mistake has been made, or stopping cooking before the completion of the cooking process.

7. Memory Key



- For entering the desired power output and cooking time.

8. Power Key



- For entering the desired power output into the unit's memory.

9. Timer Key



- For entering the desired cooking time into the unit's memory.

10. Start Key

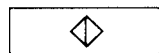

- For timer cooking.
- For restart at programmed cooking.

INSTALLATION

1. The oven surround and also the surround of the control panel is covered by a protective plastic film, and this should be removed prior to putting the oven into use.
2. **Install the oven on a flat, level surface**
Strong enough to safely bear the weight of the oven. To avoid the possibility of causing vibration or noise the oven must be in a stable position.
3. **Keep the oven away from heat and water**
Exposure to heat and water can lower oven efficiency and lead to malfunctioning, so be sure to install the oven away from external heat and water sources.
4. This oven conforms to EMC Directive 89/336 EEC, however some interference may occur if it is placed too close to a radio or TV – so keep them as far apart as possible.
5. **Exhaust vents are located at the rear of the oven so maintain a minimum spacing of 5cm (2") between the oven and any adjacent surfaces at these points.**
In an enclosed housing please maintain a minimum spacing of 20cm on the top.
Covering the exhaust vent may lead to malfunctioning. Hot air flows from these vents, so be sure not to obstruct cover or let curtains come between the oven and the rear wall.

WARNING - This appliance must be earthed

IMPORTANT

The wires in this mains lead are coloured in accordance with the following code:

Green-and-yellow: Earth.
Blue: Neutral.
Brown: Live.

As the colours of the wires in the mains lead of this appliance may not correspond with the coloured markings identifying the terminals in your plug, proceed as follows:

The wire which is coloured green-and-yellow must be connected to the terminal in the plug which is marked with the letter E or by the earth symbol  or coloured green or green-and-yellow.

The wire which is coloured blue must be connected to the terminal which is marked with the letter N or coloured black.
The wire which is coloured brown must be connected to the terminal which is marked with the letter L or coloured red.

THIS PLUG IS NOT WATERPROOF - KEEP DRY

This cord is already fitted with a moulded plug incorporating a fuse, the value of which is indicated on the pin face of the plug. Should the fuse need to be replaced, an ASTA approved BS1362 fuse must be used of the same rating marked thus: 

If the fuse cover is detachable, never use the plug with the cover omitted. If a replacement fuse cover is required, ensure it is the same colour as that visible on the pin face of the plug. Fuse covers are available at most electrical retailers.

If the plug supplied is not suitable for your socket outlet, it should be cut off and destroyed.

The end of the flexible cord should be suitably prepared and the correct plug fitted.

***WARNING: A PLUG WITH BARED FLEXIBLE CORDS IS HAZARDOUS IF ENGAGED IN A LIVE SOCKET OUTLET.**

HOW TO USE YOUR SANYO MICROWAVE OVEN SAFELY

Although your oven is provided with safety features, it is important to observe the following:

- a) It is important not to defeat or tamper with safety interlocks.
- b) Do not place any object between the oven front face and the door or allow residue to accumulate on sealing surfaces. Wipe the sealing area frequently with a mild detergent, rinse and wipe dry. Never use abrasive powders or pads.
- c) When opened, the door must not be subjected to strain, for example, a child hanging on an opened door or any load could cause the oven to fall forward to cause injury and also damage to the door.
Do not operate the oven if it is damaged, until it has been repaired by a qualified service engineer. It is particularly important that the oven closes properly and that there is no damage to the:
 - i) Door (bent)
 - ii) Hinges and Latches (broken or loosened)
 - iii) Door seals and Sealing surfaces
- d) It is dangerous for anyone other than a properly qualified service engineer trained by SANYO to carry out adjustments or repairs.

NOTE

It is quite normal for steam to be emitted around the door, or for misting to occur on the door, or even for water droplets to appear below the door during the cooking cycle. This is merely condensation from the heat of the food and does not affect the safety of your oven.
The door is not intended to seal the oven cavity completely but its special SANYO design contributes to the complete safety of the appliance.

Note: After cooking or when you stop cooking by opening the door. The fan of the oven will turn for one minute.

OTHER SAFEGUARDS:

1. Never remove the cabinet.
High voltage electricity is used in this oven, so be sure not to remove the cabinet.

2. Be careful not to spill water over the oven, especially near the air vents.
3. Never operate oven without the air filter which is located on underside of cabinet. Air Filter must be kept clean for maximum efficiency.
4. Do not operate when there is no food in the oven.
Operation of the oven when empty shortens the service life of the magnetron and causes overheating.
Also, the external components of oven melt or burn and will damage the product.
5. Do not operate without the cooking tray inside the oven.
The oven can become stained by food burning on to base of oven.
6. When cooking, never allow aluminum foil, metal skewers or other metallic objects to touch the glass viewing window or oven cavity.
This may cause sparking at the point of contact, may break the glass, or cause damage to the oven walls.
7. Do not leave the oven in unattended operation when food is heated or cooked in disposable containers of plastic, paper or other combustible materials.
8. If smoke is observed, keep the oven door closed and switch off by disconnecting the oven from the power supply.
9. Do not do anything that may interfere with the operation of the upper or lower hinges and/or latches of the oven's door. Such interference causes unit malfunctions.
10. Do not use excessive force when pressing the unit's keys, or press them with metal or sharp utensils or objects. These can damage the unit and lead to malfunctions.
11. Do not place or store things on top of the unit, as it can become quite hot during operation and there is the danger of melting or harming them.
12. Handle the unit's tray with care, as it can crack or break if dropped or struck.
13. Keep the plug clean at all times to ensure proper operation.
14. Allow the tray to cool before immersing it for cleaning. Failure to do so can result in cracking or breaking.

Note: If the supply cord is damaged, it must be replaced by SANYO SERVICE CENTRE, as a special prepared cord is required. 422 0 3390 41 000

HINTS FOR COOKING

1. Microwave cooking time
 - As when cooking with other forms of heat, microwaves can cause the moisture in foods to evaporate so that the food will burn if overheated.
 - Do not set the timer for a longer time than necessary.
 - The first time you make a dish with this oven, stop cooking a bit early and check on the cooking progress.
 - Do not overcook. Baked foods having a hard, dry brown spot after microwave cooking indicates overcooking.
2. Do not heat small quantities of food or dried foods for long periods of time.
 - Such foods may burn or catch fire, and the oven will also be affected in much the same way as if it were operating empty. Put a cup of water in the oven when heating such foods.
3. Always make sure that closed containers, such as jars of baby food, are opened and plastic pouches of vegetables are pierced before cooking.
 - Tightly closed containers could explode.
4. Avoid heating baby bottles or baby food jars. Transfer the food into a suitable container for the microwave oven. The food temperature should be tested before giving it to the baby.
5. Do not cook eggs in their shells because they will explode.
 - Prick the membrane around the yolk before frying eggs to allow steam to escape. This is because the yolk swells faster than the membrane and the egg explodes when heated quickly. Eggs cannot be boiled in this microwave oven.
6. Do not overheat
 - During defrosting, shorten the time to avoid overcooking.
7. Never use the oven as a Clothes Drying Cabinet.
Since there is no heating time guide for drying things like paper or cloth, using the oven for this purpose may lead to oven damage or fire!
8. When boiling water or other liquids, be sure to use wide mouthed containers. This will allow air bubbles to escape freely. Should a narrow mouthed container be used, air bubbles may combine to form a large bubble which may in turn cause the liquid to boil over. This may happen even after the cooking time has stopped.

MICROWAVE OVEN COOKING KNOW-HOW

1. Cooking times with quantity

- Input the cooking time that is appropriate to the quantity of foods being prepared.
- When heating double or triple quantity, use the appropriate multiple-quantity key.

Note: Before use, the user should check that utensils are suitable for used in microwave ovens.

2. To do even cooking

- Turn bulky foods over 180° degree halfway through the cooking.
- When cooking two or more items, rotate them halfway through the cooking.
- When cooking tall foods, be sure to turn them upside down halfway through the cooking.
- When cooking foods with parts of different thicknesses, protect the thinner, faster-cooking part with aluminum foil halfway through the cooking to protect them from overcooking.
- When cooking soups or sauces, stir them (once or twice) half way through the cooking.

OPERATING INSTRUCTIONS (1)

TIMER (MANUAL AND REPEAT) WITH 3 POWER SETTINGS BY TIMER KNOB

- 1) Connect main lead to power outlet.
- 2) Open the door. The oven lamp will light.
- 3) Put food in suitable containers on the tray in the oven cavity and close the door. The oven lamp will go out.

MANUAL USE

- 4) Set the timer knob to the desired time (maximum 10 minutes). The digital timer shows the set time.
- 5) To start cooking, press either "HIGH", "MEDIUM", or "LOW" power select buttons; the corresponding indicator lights up and the digital timer counts down to zero.

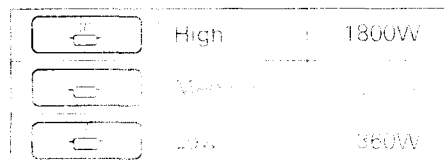

The oven lamp will light when any one of the power select buttons is pressed.

- * If you want to check cooking progress during oven operation, the door may be opened. The oven lamp will light.

The digital timer will count down to zero. When the timer reaches zero, the oven lamp will go out and the timer will stop until cooking is resumed.

To resume cooking, close the door and press previously selected power button.

Note: Other buttons will not operate the oven at this stage.

- * If you want to reduce or increase time, merely change by turning timer knob.
 - * If food is ready or you wish to cancel timer during cooking, press "C" button.
- 6) On completion of cooking time, the beep tone sounds and the microwaves stop.





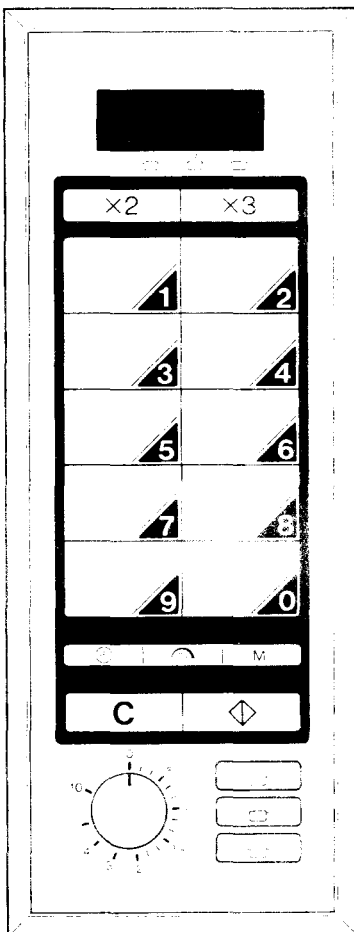







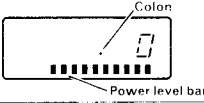

REPEAT TIMER USE

You will notice that during the microwave cooking, the timer knob will not move although the digital timer will count down to zero. If the same timer is required immediately after the first operation, merely press a power select button again. This can be repeated as often as required.

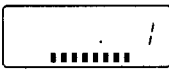

TIMER (MANUAL) COOKING BY KEYS

- 1) Connect mains lead to power outlet.
- 2) Open the door. The oven lamp will light.

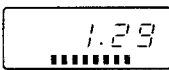
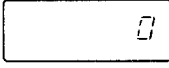
	Operational flow	Display window
1	Put food in suitable containers on the tray in the oven cavity and close the door. The oven lamp will go out.	 ● "0" will appear on the display
2	 ● Touch  key	 ● The colon will appear on the display and Power Level "10" Bar.
3	 ● Input POWER level 8 with the PROGRAMME keys ● Touch: number "8"	 ● Power Level "8" Bar.
4	 ● Touch  key	 ● No change in display
5	 ● Input the desired time with the PROGRAMME keys ● Touch number "1" of the desired 1 minute 30 seconds	 ● "1" will appear on the display
6	 ● Touch number "3"	 ● "3" will appear on the right of "1", "13" shows in the display window
7	 ● Touch another "0"	 ● "1.30" then shows in the display window
8	 ● Touch Start Key	 ● To start cooking, the corresponding indicator lights up and the digital timer counts down to zero.
9	● Cooking time ends ● Remove the food from oven	 ● The "beep" tone sounds, "0" will show. The oven lamp will go out.

Note: When you operate Max Power, don't touch " " key. Max power operation will automatically be made so you can skip operation 2 and 3. Max input timer is ten minutes.

Note: When a power select button is pressed to commence a cooking cycle, there will be an initial delay of approximately 3 seconds oven stabilisation time before the cooking cycle actually starts.











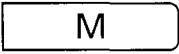

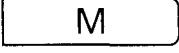

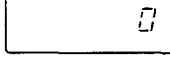

Note: Correct operation of any of the power select buttons is indicated by a short beep tone. If this tone is not heard, operate buttons again, applying firm finger pressure to centre of button. Should there still be no tone, it is an indication that the " " button needs to be operated.

OPERATING INSTRUCTIONS (2)

USING THE PROGRAMME KEY FOR MEMORY STORAGE

1. Programmed (1-Stage) Cooking

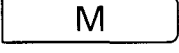
(Example) To programme the following on programme No.3: (Power Levelmax power for 30 seconds.

	Operational flow	Display window
1	 <ul style="list-style-type: none"> • Touch  key (1st time) 	 <ul style="list-style-type: none"> • The "0" will appear on the display
2	 <ul style="list-style-type: none"> • Touch  key (2nd time) 	 <ul style="list-style-type: none"> • No change
3	 <ul style="list-style-type: none"> • Touch PROGRAMME key number "3" 	 <ul style="list-style-type: none"> • Light No.3 Power level bar "10"
4	 <ul style="list-style-type: none"> • Touch "  " key 	 <ul style="list-style-type: none"> • No change
5	 <ul style="list-style-type: none"> • Input the operating time with PROGRAMME keys • First, touch number "3" 	 <ul style="list-style-type: none"> • The "3" will appear on the display
6	 <ul style="list-style-type: none"> • Then, touch number "0" 	 <ul style="list-style-type: none"> • The "0" will appear behind the "3"
7	 <ul style="list-style-type: none"> • Then, touch  key 	 <ul style="list-style-type: none"> • The "0" will appear on the display











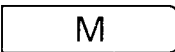

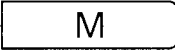

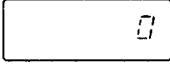



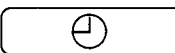

Note: When you operate with Max. power, do not touch "  " key. Max power operation automatically be made.

OPERATING INSTRUCTIONS (3)

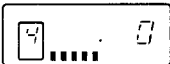
USING THE PROGRAMME KEY FOR MEMORY STORAGE

2. Programmed (1-Stage) Cooking

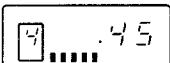
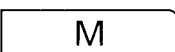

(Example) To programme the following on programme No.4: (Power Level 5 for 45 seconds

	Operational flow	Display window
1	 • Touch  key (1st time).	 • The "0" will appear on the display.
2	 • Touch  key (2nd time).	 • No change.
3	 • Touch PROGRAMME key number "4".	 • Light No. 4 Power level "10" bar.
4	 • Touch  key.	 • No change.
5	 • Input "power level 5" with PROGRAMME key Touch number "5".	 • Power Level "5" Bar.
6	 • Touch  key	 • No change.
7	 • Input the operating time with the PROGRAMME keys. Touch number "4".	 • The "4" will appear on the display.
8	 • Then, touch number "5".	 • The "5" will appear behind the "4". "45" then show in the display window.
9	 • Then, touch  key.	 • The "0" will appear on the display.

POWER LEVEL LIST

POWER LEVEL (Input figure)	POWER (W)	Max. Input time
max power (no Input)	1800	6 min. 00 sec.
9	1620	"
8	1440	"
7	1260	"
6	1080	"
5	900	30 min. 00 sec.
4	720	"
3	540	"
2	360	"
1	180	"
0	0	"

Note:

1. A "beep" tone sounds whenever any key is touched.
2. If the desired numeral is not displayed, touch " " and restart (procedures) from the beginning.
3. If an operating time over the MAX. input time is selected, subsequent key operation is impossible.
4. To enter 1 minute (60 seconds) input "100".
5. The storing process is completed by touching " " key last.

















If " " key is not touched, the information will not be retained and previous memory information be retained.

3. Programmed (2-Stage) Cooking

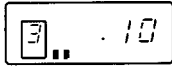
(Example) To programme the following on programme No. 3:

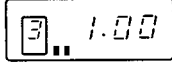
First (Max power for 30 seconds. Second (Power Level 2 for 10 minutes.

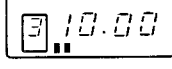
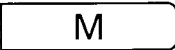

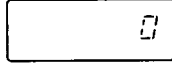





Operating flow 1~6 is the same as step 1~6 of 1-stage cooking, then: (see page 25)

	Operational flow	Display window
7	 <ul style="list-style-type: none"> • Touch  key 	 <ul style="list-style-type: none"> • The colon will appear on the display and Power Level "10" Bar.
8	 <ul style="list-style-type: none"> • Input POWER level 2 with the PROGRAMME keys • Touch: number "2" 	 <ul style="list-style-type: none"> • Power Level "2" Bar
9	 <ul style="list-style-type: none"> • Touch  key 	 <ul style="list-style-type: none"> • No change in display
10	 <ul style="list-style-type: none"> • Input the desired time with the PROGRAMME keys • Touch number "1" Of the desire 10 minutes 	 <ul style="list-style-type: none"> • "1" will appear on the display
11	 <ul style="list-style-type: none"> • Touch number "0" 	 <ul style="list-style-type: none"> • "0" will appear on the right of "1", "10" shows in the display window
12	 <ul style="list-style-type: none"> • Touch another "0" 	 <ul style="list-style-type: none"> • "100" then shows in the display window
13	 <ul style="list-style-type: none"> • Touch another "0" 	 <ul style="list-style-type: none"> • "1000" then shows in the display window
14	 <ul style="list-style-type: none"> • Touch "  " key (ending input) 	 <ul style="list-style-type: none"> • "0" will appear on the display

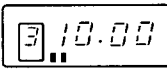

4. Confirmation of Memory

(Example) When programme No.3 is programmed as:

1st input (Max power for 30 seconds. 2nd input (Power Level 2 for 10 minutes.

	Operational Flow	Display window
1	<ul style="list-style-type: none"> • Open the door 	 <ul style="list-style-type: none"> • "0" will appear on the display
2	 <ul style="list-style-type: none"> • Touch number "3" 	 <ul style="list-style-type: none"> • Programmed No.3 • Input power Level Bar "10" • Input time 30 sec. (1st stage)
3	 <ul style="list-style-type: none"> • Touch number "3" again. 	 <ul style="list-style-type: none"> • Programmed No.3 • Input power Level Bar "2" • Input time 10 min (2nd stage)
4	 <ul style="list-style-type: none"> • Touch  key 	 <ul style="list-style-type: none"> • The "0" will appear on the display

Note:

1. Touch "  " key after confirming the contents of the unit's memory.
2. If nothing is in the memory, the programme Number will flash in the display window.
3. If you wish to change a programme memory, touch the "  " key twice and then input again as shown in pages 25 – 27.



OPERATING INSTRUCTIONS (4)

HEATING METHOD

1. Ordinary Use





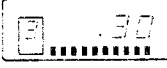
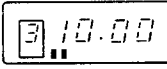
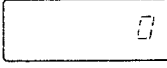

(Example) When programme No. 3 is programmed as:

First (Max power for 30 sec. Second (Power Level 2 for 10 min.

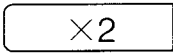
	Operational flow	Display window
1	<ul style="list-style-type: none"> Place food in oven 	 <ul style="list-style-type: none"> The "0" will appear on the display
2	 <ul style="list-style-type: none"> Touch PROGRAMME key number "3" (Heating Starts) Key "3" becomes illuminated. 	 <ul style="list-style-type: none"> Light programmed No.3 Power Level Bar "10" The rest of heating time for 1st stage will show and count down to zero.
		 <ul style="list-style-type: none"> After 1st stage is completed, the rest of heating time for 2nd stage will show and count down to zero.
3	<ul style="list-style-type: none"> Cooking time ends Remove the food from oven 	 <ul style="list-style-type: none"> The "beep" tone sounds, "0" will show

2. Multi-Quantity Key Use

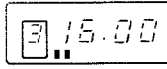
(Example) When DOUBLE is used.

	Operational flow	Display window
1	<ul style="list-style-type: none"> Place food in oven 	 <ul style="list-style-type: none"> The "0" will appear on the display
2	 <ul style="list-style-type: none"> Touch  key 	 <ul style="list-style-type: none"> "2" Will show
3	 <ul style="list-style-type: none"> Touch PROGRAMME key number "3" (Heating Starts) Key "3" becomes illuminated. 	 <ul style="list-style-type: none"> Light programmed No.3 Power Level Bar "10" The rest of heating time for 1st stage will show and count down to zero.
		 <ul style="list-style-type: none"> After 1st stage is completed, the rest of heating time for 2nd stage will show and count down to zero.
4	<ul style="list-style-type: none"> Cooking time ends Remove the food from oven 	 <ul style="list-style-type: none"> The "beep" tone sounds, "0" will show

PRECAUTION WHILE HEATING

1. Checking foods during cooking

When it is necessary to open the door while foods are cooking, the cooking programme is automatically suspended, with the programme indicator bar lit and remaining time displayed unchanged.

2. Resuming cooking after checking

To resume cooking after opening the door to check foods, close the door and touch "⏪" key.

3. Cutting cooking time short

The cooking process may be stopped at any time by touching the "C" key.

4. When a programme not entered in the unit's memory is selected

In this case, the programme NO is flashing in the display window. And the oven will then cease operation without heating.

5. Cooking time for double quantity

The cooking time for double quantity is 1.6 times the cooking time for ordinary quantity.

6. Cooking time for triple quantity

The cooking time for triple quantity is 2.1 times the cooking time for ordinary quantity.

7. Limitations on multiple-quantity cooking

When more than "Power Level 6" is being used, its max. heating time is 12 minutes. When less than "Power Level 5" is being used, its max. heating time is 60 minutes.

POWER LEVEL	Max input time			
	Double quantity		Triple quantity	
	Max input time	Heating time	Max input time	Heating time
10 ~ 6	6 min. 00 sec	9 min. 36 sec	5 min. 42 sec	12 min. 00 sec
5 ~ 1	30 min. 00 sec	48 min. 00 sec	28 min. 39 sec	60 min. 00 sec

USABLE COOKING UTENSILS AND MATERIALS

OVENPROOF GLASS

Ovenware (treated for high intensity heat), such as mixing bowls, bread dishes, pie plates, cake plates, liquid measuring cups, casseroles, and bowls without metallic decoration.

CHINA

Bowls, cups, serving pieces, plates, and platters without metallic decoration.

POTTERY

Dishes, cups, mugs, and bowls.

PLASTIC

Plastic wrap (cling film) may be used as a cover. Lay the plastic wrap loosely over the dish and press it to the sides. The dish should be deep enough so that plastic wrap will not touch the food, also the film should be pierced to allow steam to escape. As the food heats, it may cause the wrap to melt wherever it touches the food. Plastic dishes, cups, semi-rigid freezer containers, and plastic bags are usable for short cooking operations. Use with care as some softening of the plastic can occur with heat from the food.

Not suitable for microwave cooking

METAL UTENSILS

Metal utensils are not recommended because the metal shields the food from microwave energy on the bottom and sides, causing uneven cooking result. Metal utensils will also cause arcing and damage to the appliance.

METAL DECORATION

Metal-trimmed or banded dinnerware, casseroles, etc., should not be used. The metal trim interferes with normal cooking and may damage to the dish.

ALUMINUM FOIL

Large sheets or pieces of aluminum foil should be avoided because they will disrupt cooking and may cause harmful arcing. However, smaller pieces may be used to cover areas such as poultry legs and wings. Any aluminum foil use should never be closer than 1 inch from side walls of oven.

WOOD

Wooden bowls and boards will become dried out when used in the microwave oven and may split or crack.

OTHER

Avoid using cracked, flawed, or defective utensils, including ovenproof glassware.

CAUTION: DO NOT USE METAL TIES ON ANY PAPER OR PLASTIC BAGS; THE TIES BECOME HOT AND COULD CAUSE A FIRE.









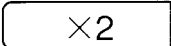
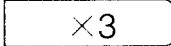

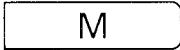

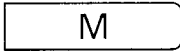



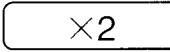

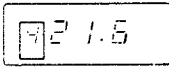
CHANGING A MULTIPLE FOR MULTIPLE QUANTITY SELECTION KEY

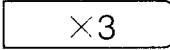
Initial

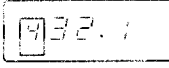
 1,6 times  2,1 times

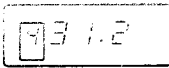
(Example) To change a multiple on programme NO.4 into the following:

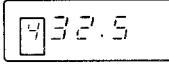
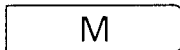









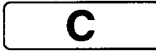

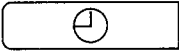



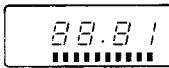

 1,6 times (No change)  2,5 times

	Operation flow		Display window	
1		• Touch  key (1st time)		• The "0" will appear on the display
2		• Touch  key (2nd time)		• No change
3		• Touch PROGRAMME key number "4"		• Light No.4 Power level "10" bar
4		• Touch  key		• First digit "2" shows  key Multiple figure of "1.6" is flashing.
5		• Touch  key		• First digit "3" shows  key Multiple figure of "2.1" is flashing.
6		• Touch number "2"		• Multiple figure is flashing.
7		• Touch number "5"		• Multiple figure is flashing.
8		• Touch "  " key (ending input)		• The "0" will appear on the display

- Note:**
1. You can change a multiple on programme NO.1 - NO.9. NO.0.
 2. If you confirm the contents of multiple quantity selection keys, you can skip operation 6 and 7.

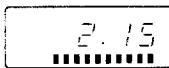
CHECKING ACCUMULATIVE COOKING TIME, NUMBER OF DOOR OPERATIONS AND CONTROL OF THE BUZZER SOUND

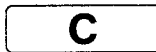
Display shows accumulative cooking time or the number of door operations by key operation. Also, you can change any remaining cooking time, buzzer sound or buzzer volume.

	Operation flow	Display window
1	 <ul style="list-style-type: none"> • Touch  key 	 <ul style="list-style-type: none"> • "0" will appear on the display
2	 <ul style="list-style-type: none"> • Touch  key 	 <ul style="list-style-type: none"> • The colon will appear on the display. Power level "10" bar.
3	 <ul style="list-style-type: none"> • Touch number "8" three times. 	 <ul style="list-style-type: none"> • The "8.88" will appear on the display.
*	Stages 1 to 3 are the same for all options. Input the 4th digit as follows to check or change the modes.	
4	 <ul style="list-style-type: none"> • Input one of the following options (1-0) using the course key. 	 <ul style="list-style-type: none"> • e.g. Input "1" (accumulative cooking time)
5	 <ul style="list-style-type: none"> • Touch  key 	 <ul style="list-style-type: none"> • All 4 digits will be flashing.
6	 <ul style="list-style-type: none"> • Touch  key again 	 <ul style="list-style-type: none"> • The number "215" shows total cooking hours OR
		 <ul style="list-style-type: none"> • In case where options' other than 1 or 2 were selected in stage 4, "0" appears on display confirming that the new setting has been accepted.
7	 <ul style="list-style-type: none"> • Touch  key 	 <ul style="list-style-type: none"> • In case of option 1 or 2, the "C" key must be pressed to clear the display. (Not necessary for options 3 to 0).

The following modes can be selected by inputting one of the numbers below at the operation stage "4".

INPUT OPTIONS

- | | |
|--|---|
| 1..... Accumulative cooking time. | 7..... The volume of the buzzer. (quiet) |
| 2..... The number of door operations. (100 times) | 8..... The volume of the buzzer. (medium) |
| 3..... Indication of remaining cooking time (When cooking is interrupted by door opening). | 9..... The volume of the buzzer. (loud) |
| 4..... To cancel remaining cooking time. | 0..... The volume of the buzzer. (none) |
| 5..... Tone of the buzzer on cooking completion (Pip. Pip, Pip) | |
| 6..... Tone of the buzzer on cooking completion (Peep) | |

CARE AND CLEANING

ALWAYS KEEP THE OVEN CLEAN

1. Cleaning the glass viewing window, the inner door panel and oven front face.

For best performance and to maintain the high degree of safety the inner door panel and oven front face should be free of food or grease build-up.

Wipe these parts with a mild detergent, rinse and wipe dry. Never use abrasive powders or pads.

2. Cleaning the oven interior

After use be sure to clean up spilled liquids, spattered oil and food debris as quickly as possible. If the oven is used when dirty, efficiency drops and the dirt gets stuck on the oven surface and may cause bad odours. Clean the interior with a cloth soaked in luke-warm water with a mild detergent dissolved in it, then rinse the soap off with a damp cloth.

In particular, the bottom of the oven interior tends to get stained from spices and food. Since this may cause odour and abnormal vibration, be sure to keep this area clean.

CAUTION: Do not wipe plastic and painted sections of the oven with bleach, thinners or other cleaning agents, as this may cause these parts to dissolve or change shape.

3. The stirrer shield (inside oven top) can be gently wiped in place or removed for washing at the sink. The shield is a flexible plastic, supported at the front, side and rear. Carefully remove the shield secured at the front tabs, pull forward to remove.

Wash only in warm (not hot) detergent water, rinse and wipe dry. Avoid hitting or bending the metal stirrer blades, as this could change the heating pattern in the oven.

To replace the shield, position it on the rails on sides and rear of the cooking chamber and secure it between the front metal tabs.

4. Clean the removable air filter regularly. (at least once a week)

Do not operate oven without air filter in position.

WHAT TO DO IF REPAIRS ARE NEEDED

If "E-21" appears on the display, Unplug the main lead, immediately, "E-21" indicates food on fire or any form of overheating in the oven.

Get in contact with your nearest Sanyo Service Centre. On no account remove or interfere with any parts or screws.

"THIS COULD PROVE VERY DANGEROUS"

Make the following simple check-up before contacting the Sanyo Service Centre:

- If the oven lamp does not light when one of the programme selection key is touched.
 1. Make sure that the mains lead is securely plugged in.
 2. Check the fuse in the plug top and ensure the plug top is wired correctly.
(Note: The appliance must be protected by a fuse)
 3. Make sure that the door is completely closed.
 4. Make sure that a programme has been stored.

- Before changing the oven lamp, please confirm the power supply plug is disconnected from the socket.
- If the oven lamp lights and the appropriate power select or preset cooking indicator is illuminated but the food is not heated;
 1. Make sure that the food is not completely covered with a metal container.
- Abnormal noise during operation.
 1. Make sure that sparking during microwave cooking is not caused by using unsuitable utensils of metal or having metal bands or trimmings, or aluminum foil or skewers.
 2. Make sure that the tray is set in the oven properly.
 3. Check whether foods or containers are touching inside walls of the oven.
- If smoke is observed, keep the oven door closed and switch off by disconnecting the oven from the power supply.

SPECIFICATIONS AND ACCESSORIES

Specifications

	EM-C2000
Power consumption	2.9KW
Microwave power output	1800W - 180W
Microwave frequency	2 450 MHz
Outer dimensions	610(W) · 493(D) · 410(H) mm
Cavity dimensions	374(W) · 413(D) · 238(H) mm
Weight	43 Kg

Accessories

Air filter.....	1
Operating instructions.....	1

CODE NO.432-6-413S-95500-A

SANYO

SANYO ELECTRIC CO., LTD
OSAKA, JAPAN

1/97 Printed in Japan