

Commercial Use Microwave Oven

OPERATING INSTRUCTIONS

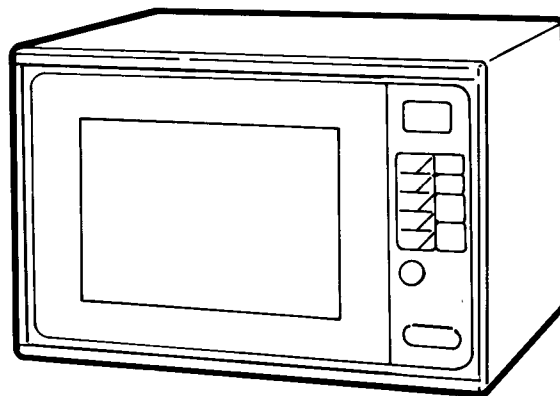

EM-C950

CONTENTS

NAME AND FUNCTION OF PARTS	2
CONTROL PANEL.....	3
INSTALLATION	4
WARNING-This appliance must be earthed.....	4
HOW TO USE YOUR SANYO MICROWAVE OVEN SAFELY	5
HINTS FOR COOKING	6
MICROWAVE OVEN COOKING KNOW-HOW.....	6
OPERATING INSTRUCTIONS	
TIMER (MANUAL) COOKING	7
USING THE PROGRAMME KEY FOR MEMORY STORAGE.....	8~11
HEATING METHOD.....	12
PRECAUTION WHILE HEATING	13
USABLE COOKING UTENSILES AND MATERIALS	13
CARE AND CLEANING	14
WHAT TO DO IF REPAIRS ARE NEEDED	14
SPECIFICATIONS AND ACCESSORIES	14

NAME AND FUNCTION OF PARTS

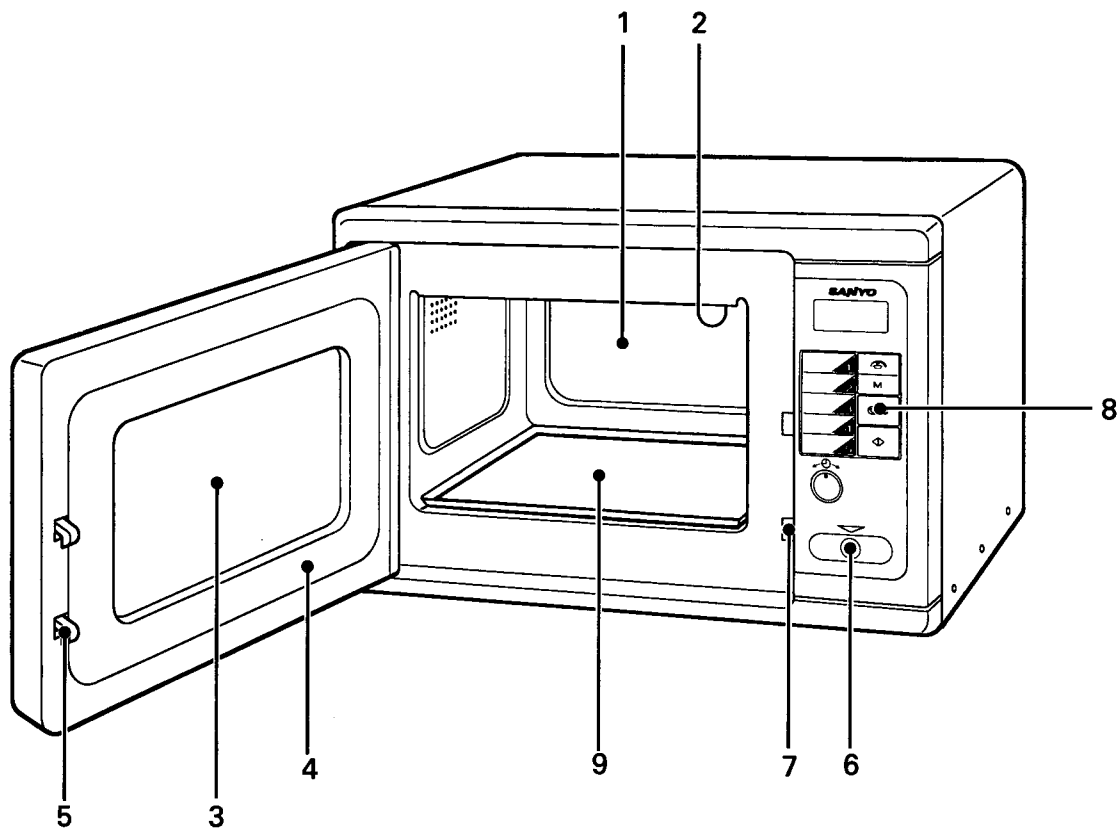

1. Oven Cavity

Wipe the chamber clean after using the oven.

2. Stirrer Shield

It protects the stirrer (radiowave stirring blade).

3. Shielded Viewing Window

Food can be checked while the microwave oven is in operation.

4. Door

The door must always be firmly closed while cooking.

5. Door Latch

6. Door Release Button

By pushing this lever the latch system cuts off all circuits and stops the oven before the door can be opened.

7. Safety Interlock System

With built-in safety interlocks.

8. Control Panel

9. Ceramic Tray

Food in suitable container is placed on this tray for cooking.

NOTE: When opening door, be sure to open fully.

CONTROL PANEL

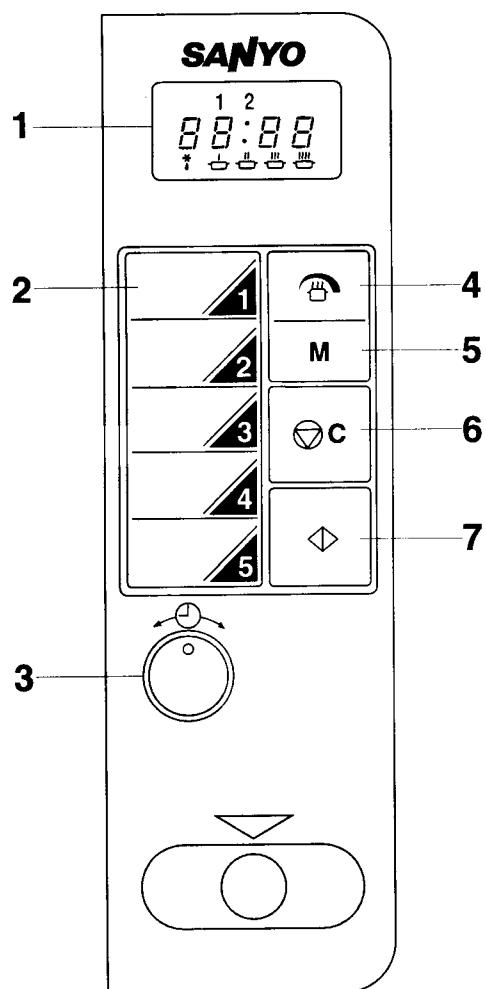

1. Displays

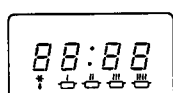

- Displays remaining cooking time.

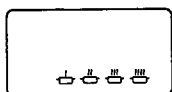

- Displays cooking power levels.

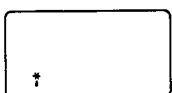

- Displays cooking defrost.

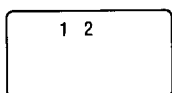

- Shows which stage the oven is cooking on.

2. Programme Selection Keys



- The unit is ready to begin operation as soon as the heating time has been programmed, using these five keys (numbered 1 to 5). The time selected will be displayed, and "count down" after the process is begun.

3. CONTROL KNOB



- Used in setting cooking time.

4. Power Key



- For entering the desired power output into the unit's memory.

5. Memory Key



- For entering the desired power output and cooking time.

6. Clear Key



- For cancelling setting, interrupting the setting process when a mistake has been made, or stopping cooking before the completion of the cooking process.

7. Start Key



- For timer cooking.
- For restart at programmed cooking.

INSTALLATION

1. The outer cabinet is covered by a protective plastic film, and this should be removed prior to putting the oven into use.
2. Install the oven on a flat, level surface strong enough to safely bear the weight of the oven. To avoid the possibility of causing vibration or noise the oven must be in a stable position.
3. **Keep the oven away from heat and water**
Exposure to heat and water can lower oven efficiency and lead to malfunctioning, so be sure to install the oven away from external heat and water sources.
4. This oven conforms to EMC Directive 89/336/EEC, however some interference may occur if it is placed too close to a radio or TV, so keep them as far apart as possible.

5. **Exhaust vents are located at the rear of the oven so maintain a minimum spacing of 5cm (2") between the oven and any adjacent surfaces at these points.**
In an enclosed housing, please maintain a minimum spacing of 20cm on the top.
Covering the exhaust vent may lead to malfunctioning. Hot air flows from these vents, so be sure not to obstruct cover or let curtains come between the oven and the rear wall.

WARNING - This appliance must be earthed

IMPORTANT

The wires in this mains lead are coloured in accordance with the following code:

Green-and-yellow: Earth.
Blue: Neutral.
Brown: Live.

As the colours of the wires in the mains lead of this appliance may not correspond with the coloured markings identifying the terminals in your plug, proceed as follows:

The wire which is coloured green-and-yellow must be connected to the terminal in the plug which is marked with the letter E or by the earth symbol \perp or coloured green or green-and-yellow.

The wire which is coloured blue must be connected to the terminal which is marked with the letter N or coloured black or blue. The wire which is coloured brown must be connected to the terminal which is marked with the letter L or coloured red or brown.

THIS PLUG IS NOT WATERPROOF - KEEP DRY

This cord is already fitted with a moulded plug incorporating a fuse, the value of which is indicated on the pin face of the plug. Should the fuse need to be replaced, an ASTA approved BS1362 fuse must be used of the same rating, marked thus. 

If the fuse cover is detachable, never use the plug with the cover omitted. If a replacement fuse cover is required, ensure it is the same colour as that visible on the pin face of the plug. Fuse covers are available from Sanyo Service Centre.

If the plug supplied is not suitable for your socket outlet, it should be cut off and destroyed*. The end of the flexible cord should be suitably prepared and the correct plug fitted.

***WARNING: A PLUG WITH BARED FLEXIBLE CORDS IS HAZARDOUS IF ENGAGED IN A LIVE SOCKET OUTLET.**

HOW TO USE YOUR SANYO MICROWAVE OVEN SAFELY

Although your oven is provided with safety features, it is important to observe the following:

- a) It is important not to tamper with safety interlocks.
- b) Do not place any object between the oven front face and the door or allow residue to accumulate on sealing surfaces. Wipe the sealing area frequently with a mild detergent, rinse and wipe dry. Never use abrasive powders or pads.
- c) When opened, the door must not be subjected to strain, for example, a child hanging on an opened door or any load could cause the oven to fall forward to cause injury and also damage to the door.
Do not operate the oven if it is damaged, until it has been repaired by a qualified service engineer. It is particularly important that the oven door closes properly and that there is no damage to the :
 - i) Door (bent)
 - ii) Hinges and Latches (broken or loosened)
 - iii) Door seals and Sealing surfaces
- d) It is dangerous for anyone other than a properly qualified service engineer trained by SANYO to carry out adjustments or repairs.

NOTE

It is quite normal for steam to be emitted around the door, or for misting to occur on the door, or even for water droplets to appear below the door during the cooking cycle. This is merely condensation from the heat of the food and does not affect the safety of your oven.

The door is not intended to seal the oven cavity completely but its special SANYO design contributes to the complete safety of the appliance.

OTHER SAFEGUARDS:

1. Never remove the cabinet.
High voltage electricity is used in this oven, so be sure not to remove the cabinet.
2. Be careful not to spill water over the oven, especially, near the air vents.
3. Do not operate when there is no food in the oven.
Operation of the oven when empty shortens the service life of the magnetron and causes overheating.
Also, the internal components of oven melt or burn and will damage the product.
4. Do not operate without the ceramic tray inside the oven.
The oven can become stained by food burning on to the base of oven.
5. When cooking, never allow aluminum foil, metal skewers or other metallic objects to touch the glass viewing window or oven cavity.
This may cause sparking at the point of contact, may break the glass, or cause damage to the oven walls.
6. Do not do anything that may interfere with the operation of the upper or lower hinges and/or latches of the oven's door. Such interference causes unit malfunctions.
7. Do not use excessive force when pressing the unit's keys, or press them with metal or sharp utensils or objects. These can damage the unit and lead to malfunctions.
8. Do not place or store things on top of the unit, as it can become quite hot during operation and there is the danger of melting or harming them.
9. Keep the plug clean at all times to ensure proper operation.
10. Do not leave the oven in unattended operation when food is heated or cooked in disposable containers of plastic, paper or other combustible materials.
11. The instruction sheet shall warn the user that the contents of feeding bottles and baby food jars are to be stirred or shaken and that the temperature is to be checked before consumption to avoid burns.
12. If smoke is observed, keep the oven door closed, and switch off or disconnect the oven from the power supply.

NOTE: If the supply cord is damaged, it must be replaced by SANYO SERVICE CENTRE, as a special prepared cord is required. (617 144 6142)

HINTS FOR COOKING

1. Microwave cooking time

- As when cooking with other forms of heat, microwaves can cause the moisture in foods to evaporate so that the food will burn if overheated.
- Do not set the timer for a longer time than necessary.
- The first time you make a dish with this oven, stop cooking a bit early and check on the cooking progress.
- Do not overcook. Baked foods having a hard, dry brown spot after microwave cooking indicates overcooking.

2. Do not heat small quantities of food or dried foods for long periods of time.

- Such foods may burn or catch fire, and the oven will also be affected in much the same way as if it were operating empty. Put a cup of water in the oven when heating such foods.

3. Always make sure that closed containers, such as jars of baby food, are opened and plastic pouches of vegetables are pierced before cooking.

- Tightly closed containers could explode.

4. Do not cook eggs in their shells because they will explode.

- Prick the membrane around the yolk before frying eggs to allow steam to escape. This is because the yolk swells faster than the membrane and the egg explodes when heated quickly. Eggs cannot be boiled in this microwave oven.

5. Never use the oven as a Clothes Drying Cabinet.

Since there is no heating time guide for drying things like paper or cloth, using the oven for this purpose may lead to oven damage or Fire!

6. When boiling water or other liquids, be sure to use wide mouthed containers. This will allow air bubbles to escape freely. Should a narrow mouthed container be used, air bubbles may combine to form a large bubble which may in turn cause the liquid to boil over. This may happen even after cooking has stopped.

MICROWAVE OVEN COOKING KNOW-HOW























- Before use, the user should check that utensils are suitable for use in microwave ovens. (see page 13)
- Turn bulky foods over (180° degree) halfway through the cooking.
- When cooking two or more items, rotate them halfway through the cooking.
- When cooking tall foods, be sure to turn them upside down halfway through the cooking.

- When cooking foods with parts of different thicknesses, protect the thinner, faster-cooking part with aluminum foil halfway through the cooking to protect them from overcooking.
- When cooking soups or sauces, stir them (once or twice) halfway through the cooking.

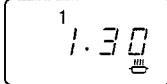

USING THE PROGRAMME KEY FOR MEMORY STORAGE

Programmed (1-Stage) Cooking at lower power level.

(Example) To programme the following on programme No.4: (Power Level  (450W). for 1 min 30 seconds.

	Operational flow	Display window
1	 <ul style="list-style-type: none"> • Touch  key (1st time) 	 <ul style="list-style-type: none"> • "0" will appear on the display
2	 <ul style="list-style-type: none"> • Touch  key (2nd time) 	 <ul style="list-style-type: none"> • No change
3	 <ul style="list-style-type: none"> • Touch PROGRAMME key number "4" 	 <ul style="list-style-type: none"> • The "4" will appear on the display.
4	 <ul style="list-style-type: none"> • Touch "" key 	 <ul style="list-style-type: none"> • "1" and Power Level "" will turn on.
5	 <ul style="list-style-type: none"> • Touch  key To select "". 	 <ul style="list-style-type: none"> • "1" and "" will appear on the display.
6	 <ul style="list-style-type: none"> • Set time. 	 <ul style="list-style-type: none"> • The setting time and the colon will appear on the display.
7	 <ul style="list-style-type: none"> • Then, touch  key 	 <ul style="list-style-type: none"> • The "0" will appear on the display

NOTE:













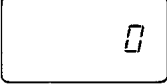



1. If the desired numeral is not displayed, touch " " and restart (procedures) from the beginning.
2. If an operating time over the Max. input time is selected, subsequent key operation is impossible.
3. The storing process is completed by touching " " key.
If " " key is not touched, the new settings will not be stored and the previous memory information will be retained.

OPERATING INSTRUCTIONS

USING THE PROGRAMME KEY FOR MEMORY STORAGE

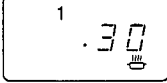
1. Programmed (1-Stage) Cooking at maximum power.

(Example) To programme the following on programme No.3: (Power Level..... max power for 30 seconds.









	Operational flow	Display window
1	 <ul style="list-style-type: none"> • Touch  key (1st time) 	 <ul style="list-style-type: none"> • "0" will appear on the display
2	 <ul style="list-style-type: none"> • Touch  key (2nd time) 	 <ul style="list-style-type: none"> • No change
3	 <ul style="list-style-type: none"> • Touch PROGRAMME key number "3" 	 <ul style="list-style-type: none"> • The program key number "3" will appear on the display.
4	 <ul style="list-style-type: none"> • Touch  key 	 <ul style="list-style-type: none"> • "1" and Power Level "" will appear on the display.
5	 <ul style="list-style-type: none"> • Set time. 	 <ul style="list-style-type: none"> • The setting time and the colon will appear on the display.
6	 <ul style="list-style-type: none"> • Then, touch  key 	 <ul style="list-style-type: none"> • "0" will appear on the display

2. Programme (2-Stage) Cooking

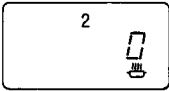
(Example) To programme the following on programme No. 3:

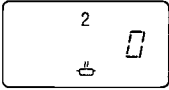
First (Max power for 30 seconds. Second (Power Level "II" for 10 minutes.

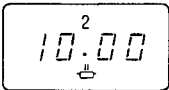
Operating flow 1~6 is the same as step 1~6 of 1-stage cooking, then: (see page 9)

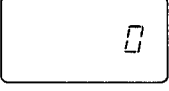
	Operational flow	Display window
7	 <ul style="list-style-type: none"> • Touch  key 	 <ul style="list-style-type: none"> • "2" and Power Level "IIII" will turn on.
8	 <ul style="list-style-type: none"> • Touch  key To select "II". 	 <ul style="list-style-type: none"> • "2" and "II" will appear on the display.
9	 <ul style="list-style-type: none"> • Set time 	 <ul style="list-style-type: none"> • The setting time and the colon will appear on the display.
10	 <ul style="list-style-type: none"> • Touch "M" key (ending input) 	 <ul style="list-style-type: none"> • "0" will appear on the display









OPERATING INSTRUCTIONS

USING THE PROGRAMME KEY FOR MEMORY STORAGE

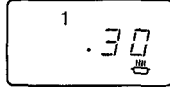

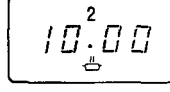
3. Confirmation of Memory

(Example) When programme No.3 is programmed as:

1st input (Max power for 30 seconds. 2nd input (Power Level "II" for 10 minutes.

	Operational flow	Display window
1	<ul style="list-style-type: none"> Open the door 	 <ul style="list-style-type: none"> "0" will appear on the display
2	 <ul style="list-style-type: none"> Touch number "3" 	 <ul style="list-style-type: none"> Programmed No.3 Input power Level Bar "III" Input time 30 sec. (1st stage)
3	 <ul style="list-style-type: none"> Touch number "3" again. 	 <ul style="list-style-type: none"> Programmed No.3 Input power Level Bar "II" Input time 10 min (2nd stage)
4	 <ul style="list-style-type: none"> Touch  key 	 <ul style="list-style-type: none"> The "0" will appear on the display



NOTE:

1. Touch " " key after confirming the contents of the unit's memory.
2. If nothing is in the memory, the "0" appears on the display.
3. If you wish to change a programme memory, touch the " " key twice and then input again as shown in pages 8-10.

HEATING METHOD

(Example) When programme No. 3 is programmed as:

First (Max power for 30 seconds. Second (Power Level "III" for 10 minutes.

	Operational flow	Display window
1	<ul style="list-style-type: none"> Place food in oven 	<div style="border: 1px solid black; padding: 5px; display: inline-block; text-align: center;">0</div> <ul style="list-style-type: none"> "0" will appear on the display
2	 <ul style="list-style-type: none"> Touch PROGRAMME key number "3" (Heating Starts) 	<div style="border: 1px solid black; padding: 5px; display: inline-block; text-align: center;"> ¹ .30  </div> <ul style="list-style-type: none"> Power Level "III" The rest of heating time for 1st stage will show and count down to zero.
		<div style="border: 1px solid black; padding: 5px; display: inline-block; text-align: center;"> ² 10.00  </div> <ul style="list-style-type: none"> After 1st stage is completed, the rest of heating time for 2nd stage will show and count down to zero.
3	<ul style="list-style-type: none"> Cooking time ends Remove the food from oven 	<div style="border: 1px solid black; padding: 5px; display: inline-block; text-align: center;">0</div> <ul style="list-style-type: none"> The "beep" tone sounds, "0" will show

PRECAUTION WHILE HEATING

1. Checking foods during cooking

When it is necessary to open the door while foods are cooking, the cooking programme is automatically suspended, with the programme indicator bar lit and remaining time displayed unchanged.

2. Resuming cooking after checking

To resume cooking after opening the door to check foods, close the door and touch “” key.

3. Cutting cooking time short

The cooking process may be stopped at any time by touching the “” key.

4. When a programme not entered in the unit's memory is selected

“0” will appear on the display and the oven does not operate.

USABLE COOKING UTENSILS AND MATERIALS

OVENPROOF GLASS

Ovenware (treated for high intensity heat), such as mixing bowls, bread dishes, pie plates, cake plates, liquid measuring cups, casseroles, and bowls without metallic decoration.

CHINA

Bowls, cups, serving pieces, plates, and platters without metallic decoration.

POTTERY

Dishes, cups, mugs, and bowls.

PLASTIC

Plastic wrap (cling film) may be used as a cover. Lay the plastic wrap loosely over the dish and press it to the sides. The dish should be deep enough so that plastic wrap will not touch the food, also the film should be pierced to allow steam to escape. As the food heats, it may cause the wrap to melt wherever it touches the food. Plastic dishes, cups, semi-rigid freezer containers, and plastic bags are usable for short cooking operations. Use with care as some softening of the plastic can occur with heat from the food.

Not suitable for microwave cooking

METAL UTENSILS

Metal utensils are not recommended because the metal shields the food from microwave energy on the bottom and sides, causing uneven cooking result. Metal utensils will also cause arcing and damage to the appliance.

METAL DECORATION

Metal-trimmed or banded dinnerware, casseroles, etc., should not be used. The metal trim interferes with normal cooking and damage may result.

ALUMINIUM FOIL

Large sheets or pieces of aluminium foil should be avoided because they will disrupt cooking and may cause harmful arcing. However, smaller pieces may be used to cover areas such as poultry legs and wings. Any aluminium foil use should never be closer than 1 inch from side walls of oven.

WOOD

Wooden bowls and boards will become dried out when used in the microwave oven and may split or crack.

OTHER

Avoid using cracked, flawed, or defective utensils, including ovenproof glassware.

CAUTION: DO NOT USE METAL TIES ON ANY PAPER OR PLASTIC BAGS; THE TIES BECOME HOT AND COULD CAUSE A FIRE.

CARE AND CLEANING

ALWAYS KEEP THE OVEN CLEAN

1. Cleaning the door viewing window, the inner door panel and oven front face.

For best performance and to maintain the high degree of safety the inner door panel and oven front face should be free of food or grease build-up.

Wipe these parts with a mild detergent, rinse and wipe dry. Never use abrasive powders or pads.

2. Cleaning the oven interior

After use be sure to clean up spilled liquids, spattered oil and food debris as quickly as possible. If the oven is used when dirty, efficiency drops and the dirt gets stuck on the oven surface and may cause bad odours. Clean the interior with a cloth soaked in luke-warm water with a mild detergent dissolved in it, then rinse the soap off with a damp cloth.

In particular, the bottom of the oven interior tends to get stained from spices and food. Since this may cause odour and fire, be sure to keep this area clean.

CAUTION: Do not wipe plastic and painted sections of the oven with bleach, thinners or other cleaning agents, as this may cause these parts to dissolve or change shape.

3. The stirrer shield (inside oven top) can be gently wiped in place or removed for washing at the sink. The shield is made of flexible plastic, supported at the front, sides and rear. Carefully remove the stirrer shield; pull it forward to lift out. Wash only in warm (not hot) detergent water, rinse and wipe dry. Avoid hitting or bending the metal stirrer blades, as this could change the heating pattern in the oven. To replace the shield, put it on the rails on the sides and at the rear of the cooking chamber.

WHAT TO DO IF REPAIRS ARE NEEDED

Get in contact with your nearest Sanyo Service Centre. On no account remove or interfere with any parts or screws.

"THIS COULD PROVE VERY DANGEROUS"

Make the following simple check-up before contacting the Sanyo Service Centre:

- If the interior lamp does not light up when the CONTROL KNOB is set, and the START KEY () is touched:
 1. Make sure that the power cord is securely plugged in.
 2. Make sure that the door is properly closed.
 3. Check the fuse or circuit breaker in the power supply box in your home.

- If the inside lamp lights but the food is not heated:

Make sure that the food is not covered with aluminium foil.

- Noisy operation:

1. Make sure that no sparks are being produced due to the use of metal utensils.
2. Make sure that the contents of the oven are not touching the stirrer shield.

- Before changing the oven lamp, please confirm the power supply plug is disconnected from the socket.

SPECIFICATIONS AND ACCESSORIES

Specifications

Model	EM-C950
Microwave power output	900W~80W
Microwave frequency	2450MHz
Outer dimensions	520(W)×413(D)×356(H)mm
Cavity dimensions	330(W)×348(D)×177(H)mm
Weight	19Kg

Accessories

Menu Sheet.....	1
Operating instructions.....	1

SANYO

SANYO ELECTRIC CO., LTD
OSAKA, JAPAN

CODE NO.432-6-414S-16300

7/96 Printed in Japan