

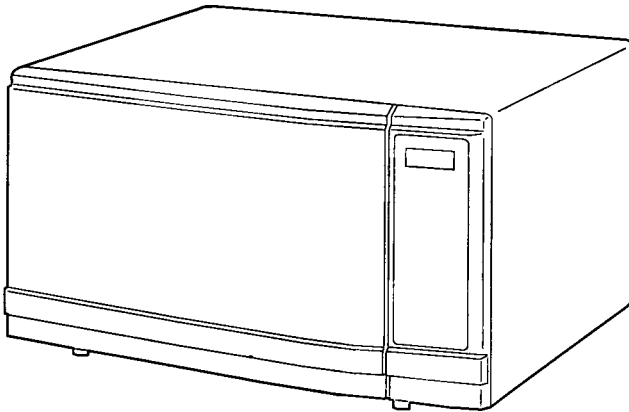

INSTRUCTION MANUAL

**EM-N202
EM-NI08
EM-MI07**

Microwave Oven



Read these instructions carefully before using your microwave oven.
If you follow the instructions, your oven will provide you with many years of
good service.

SAVE THESE INSTRUCTIONS

PRECAUTIONS TO AVOID POSSIBLE EXPOSURE TO EXCESSIVE MICROWAVE ENERGY

- (a) Never interfere or tamper with safety interlocks.
- (b) Do not place any object between the oven front face and the door or allow soil or cleaner residue to accumulate on sealing surfaces. Wipe the door sealing area frequently with a mild detergent, rise and wipe dry. Never use abrasive powders or pads.
- (c) When open, the door must not be subjected to strain; for example, a child hanging on the opened door or any load on it could cause the oven to fall forward, and the weight could also damage the door.
- (d) Do not operate the oven if it is damaged. It is particularly important that the oven door close properly and that there is no damage to the:
 - (1) DOOR (bent)
 - (2) HINGES AND LATCHES (broken or loosened)
 - (3) DOOR SEALS AND SEALING SURFACES

SPECIFICATIONS

Model:	EM-N202/N108/M107
Power Consumption:	1 150W
Maximum Output:	800W*
Oven Capacity:	17L
Turntable Diameter:	275 mm
Dimensions: (w x h x d)	461 x 256 x 355 mm
Weight: Approx.	12.5 kg

Specifications subject to change without notice.

*According to IEC-705 test procedures. The IEC-705 test procedure is an internationally recognized method of rating microwave wattage output.

Please record your product's information

When you call to request service, you need to know your complete model number and serial number. Please fill in the information below. Please also record purchase date, price and where purchased.

Model Number: _____ (Located on the front of the oven)

Serial Number: _____ (Located on the front of the oven)

Date of Purchase: _____

Purchase Price: _____

Where Purchased: _____

TABLE OF CONTENTS

SAFETY

■ Proper and Safe Use of Your Oven	4
■ Important Safety Instructions	5
■ Earthing Instructions	6
■ Utensils	6

SET UP

■ Names of Oven Parts and Accessories	8
■ Turntable installation	8
■ Installation	9

OPERATION

■ Operating Instructions for EM-N108/N202	
• Control Panel and Features	10
• Setting Clock	12
• Child Lock-Out	12
• Kitchen Timer	13
• Add 30 Seconds	13
• Time Cooking	14
• Direct Access Cooking	15
• Automatic Defrost By Weight.	16
• Quick Reheating	18
■ Operating Instructions for EM-M107	19

MAINTENANCE

■ Troubleshooting	20
■ Questions and Answers	21
■ Cleaning	21

SAFETY

SET UP

OPERATION

MAINTENANCE

SAFETY

PROPER AND SAFE USE OF YOUR OVEN

- The oven must be level.
 - The turntable and turntable roller rest must be in the oven during cooking.
 - Place the cookware gently on the turntable and handle it carefully to avoid possible breakage.
 - The oven has several built-in safety switches to ensure that the power remains off when the door is open. Do not tamper with these switches.
 - Do not operate the microwave oven when empty.
 - Do not overcook food. A small quantity of food with low moisture content or high fat or sugar content can burn.
 - Do not cook bacon directly on the turntable. Excessive local heating of the turntable may cause it to break.
 - When heating food in plastic or paper containers, check the oven frequently due to the possibility of cause fires in the oven.
 - Do not place liquids or other foods with sealed containers in the microwave oven, it may explode.
 - Avoid heating baby bottles or baby food jars. Transfer the food into a suitable container for the microwave oven. The food temperature should be tested before giving it to the baby.
 - Do not heat narrow-necked containers, such as syrup bottles.
 - Do not attempt to deep-fry in your microwave oven as the temperature of oil cannot be controlled.
 - Do not heat cans. Transfer the contents into a microwave-safe dish before heating.
 - Do not use this microwave oven for commercial purposes. This microwave oven is made for household use only.
- It is quite normal for steam to be emitted around the door, for misting to occur on the door, or even for water droplets to appear below the door during the cooking cycle. This is merely condensation from the heat of the food.

WARNING -

- (a) Do not adjust or repair microwave oven yourself. Do not operate the oven if it is damaged, until it has been repaired by a service engineer trained by the manufacturer,
- (b) It is dangerous for anyone other than a properly qualified engineer trained by the manufacturer to carry out adjustments or repairs.
- (c) If the power cord is damaged, it must be replaced by a special prepared cord available from the Manufacturer or its Service Agent,
- (d) On no account remove or interfere with any parts or screws. **THIS COULD PROVE VERY DANGEROUS.**
- (e) Before use, the user should check that utensils are suitable for use in microwave ovens.

IMPORTANT SAFETY INSTRUCTIONS

When using electrical appliances, basic safety precautions should be followed, including the following:

WARNING - To reduce the risk of burns, electric shock, fire, injury to persons or exposure to excessive microwave energy:

1. Read all instructions before using.
2. As with most cooking appliances, close supervision is necessary to reduce the risk of a fire in the oven cavity.
4. Use this oven only for its intended uses as described in the manual. It is not designed for industrial or laboratory use. Never use corrosive chemicals or vapours in this oven.

If a fire should start or smoke is observed:

- Keep the oven door closed
- Turn the oven off, and
- Disconnect the power cord or shut off power at the fuse or circuit breaker panel.

Keep in mind the following rules at all times:

- a. Do not overcook food. Overcooked food can cause fires in the oven. Carefully attend to the oven's activities, especially if paper, plastic, or other combustibles are inside.
 - b. Do not store combustible items such as bread, cookies, paper products, etc. inside the oven. They may catch fire if turned on accidentally.
 - c. Do not use wire twist-ties in the oven. Be sure to inspect purchased items for wire twist-ties and remove before placing food in the oven
5. As with any appliance, children should use the oven only under adult supervision.
 6. Do not store or use this appliance outdoors.
 7. Keep the oven away from heat and water sources. Exposure to heat and water can lower efficiency and lead to malfunctioning.
 8. When heating water or other liquids, use a wide necked container to allow air bubbles to escape freely. Using narrow-necked containers may cause the liquid to boil over. This may happen even after the cooking has stopped.
 9. It is important to keep the door and the oven interior clean. (See Cleaning instructions on page 21.)
 10. To prevent delayed eruptive boiling of hot liquids and beverages or scalding, stir liquid before placing the container in the oven and again halfway through cooking time. Let stand in the oven for a short time and stir again before removing the container.
3. Some products such as eggs in the shell, water with oil or fat, sealed containers and closed glass jars may explode and therefore should not be heated in this oven.

SAVE THESE INSTRUCTIONS

EARTHING INSTRUCTIONS

This appliance must be earthed. If there is an electrical short circuit, earthing reduces the risk of electric shock by providing an escape wire for the electric current. This appliance is equipped with a cord that has a earthing wire with a earthing plug. The plug must be plugged into an outlet that is properly installed and earthed.

The electrical power cord must be kept dry and must not be pinched or crushed in any way.

WARNING - Improper use of the grounding plug can result in electric shock.

UTENSILS

A CAUTION

Personal injury Hazard
•Tightly-closed utensils could explode. Closed containers are opened and plastic pouches pierced before cooking,

See next page for further instructions “Materials you can use in microwave oven or to be avoided in microwave oven.”

There may be certain non-metallic utensils that are not safe to use for microwaving. If in doubt, you can test the utensil in question following the procedure below.

Utensil Test:

1. Fill a microwave-safe container with 1 cup of cold water (250 mL) along with the utensil in question.
2. Cook on maximum power (P100) for 1 minute.
3. Carefully feel the utensil.

If the empty utensil is warm, do not use it for microwave cooking.

Do not exceed 1 minute testing time.

Materials you can use in microwave oven

Utensils	Remarks
Aluminum foil	Shielding only. Small smooth pieces can be used to cover thin parts of meat or poultry to prevent overcooking. Arcing can occur if foil is too close to oven walls. The foil should be at least 2.5 cm away from oven walls.
Browning dish	Follow manufacturer's instructions, The bottom of browning dish must be at least 5 mm above the turntable. Incorrect usage may cause the turntable to break.
Dinnerware	Microwave-safe only. Follow manufacturer's instructions. Do not use cracked or chipped dishes.
Glass jars	Always remove lid. Use only to heat food until just warm. Most glass jars are not heat resistant and may break.
Glassware	Heat-resistant oven glassware only. Make sure there is no metallic trim. Do not use cracked or chipped dishes.
Oven cooking bags	Follow manufacturer's instructions. Do not close with metal tie. Make slits to allow steam to escape.
Paper plates and cups	Use for short-term cooking/warming only. Do not leave oven unattended while cooking.
Paper towels	Use to cover food for reheating and absorbing fat. Use with supervision for a short-term cooking only.
Parchment paper	Use as a cover to prevent spattering or a wrap for steaming.
Plastic	Microwave-safe only. Follow the manufacturer's instructions. Should be labeled "Microwave Safe." Some plastic containers soften as the food inside gets hot. "Boiling bags" and tightly closed plastic bags should be slit, pierced or vented as directed by package.
Plastic wrap	Microwave-safe only. Use to cover food during cooking to retain moisture. Do not allow plastic wrap to touch food.
Thermometers	Microwave-safe only (meat and candy thermometers).
Wax paper	Use as a cover to prevent splattering and to retain moisture.

Materials to be avoided in microwave oven

Utensils	Remarks
Aluminum tray	May cause arcing. Transfer food into microwave-safe dish.
Food carton with metal handle	May cause arcing. Transfer food into microwave-safe dish.
Metal or metal-trimmed utensils	Metal shields the food from microwave energy. Metal trim may cause arcing.
Metal twist ties	May cause arcing and could cause a fire in the oven.
Paper bags	May cause a fire in the oven.
Plastic foam cups	Plastic foam may melt or contaminate the liquid inside when exposed to high temperature.
Wood	Wood will dry out when used in the microwave oven and may split or crack.

SET UP

NAMES OF OVEN PARTS AND ACCESSORIES

Remove the oven and all materials from the carton
Your oven comes with the following accessories:

Turntable	1
Turntable roller rest	1
Instruction Manual	1

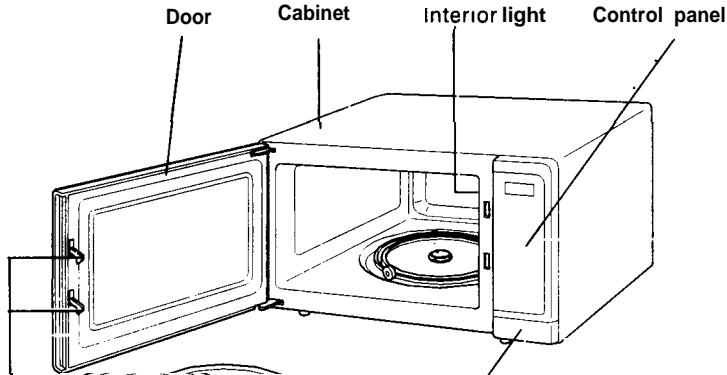

Safety interlock system
Shuts off oven power if door is opened during operation.

Door release button

- Press the button to open door.
- When you open the door during cooking process, the cooking stops without canceling the program. Cooking resumes when the door is closed. (EM-M 107). Press START to resume cooking. (EM-NI08, N202)

TURNTABLE INSTALLATION

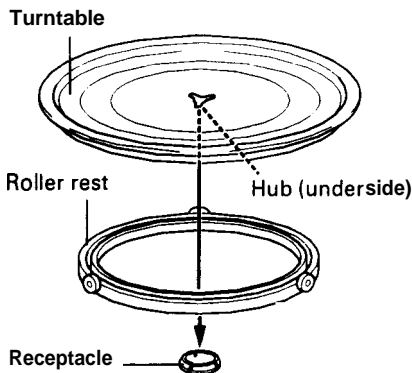

1. Place the roller rest on the cavity bottom.
2. Place the turntable on top of the roller rest as shown in the diagram. Make sure the turntable hub is securely locked in the receptacle.

- Never place the turntable upside down. The turntable should never be restricted.
- Both turntable and roller rest must always be used during cooking.
- All food and containers of food are always placed on the turntable for cooking.
- The turntable returns to its original starting position when cooking is finished. The light and fan will remain on but microwave power is turned off, (EM-N108, N202)
- The turntable rotates clockwise and counterclockwise; this is normal.
- If turntable or roller rest cracks or breaks, contact your nearest authorized service center.

INSTALLATION

Remove all packing material and accessories.

Examine the oven for any damage such as dents or a broken door

Do not install if oven is damaged.

1. Select a level surface that provides enough open space for the inlet and/or outlet vents.

- Leave a minimum clearance of 7.5 cm above the oven.
- Do not remove the legs from the bottom of the oven to ensure proper airflow.
- Blocking the inlet and/or outlet opening can damage the oven.
- Do not install oven over a range, cooktop or other heat-producing appliance.
- Place the oven as far away from radios and TV's as possible. Operation of microwave oven may cause interference to your radio, TV. Plug the microwave oven into a different outlet.
- When the cabinet is covered with a protective film, remove the film to fully show the intended colour and finish.

2. Plug your oven into a standard household outlet.

When installing in a Built-in situation, you must allow a minimum of 7.5cm on each side and the top and at the back of the microwave oven for ventilation. Failing to do so might cause damage to the microwave oven.

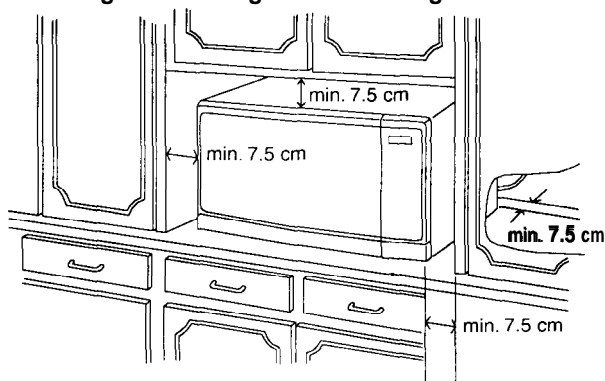

A minimum clearance of 7.5 cm is required between the oven and any adjacent walls including the back wall.

CAUTION: Use with care when handling oven. The control panel side of oven is heavy inside

OPERATION

OPERATING INSTRUCTIONS FOR EM-N108/N202 CONTROL PANEL AND FEATURES

EM-N108

EM-N202

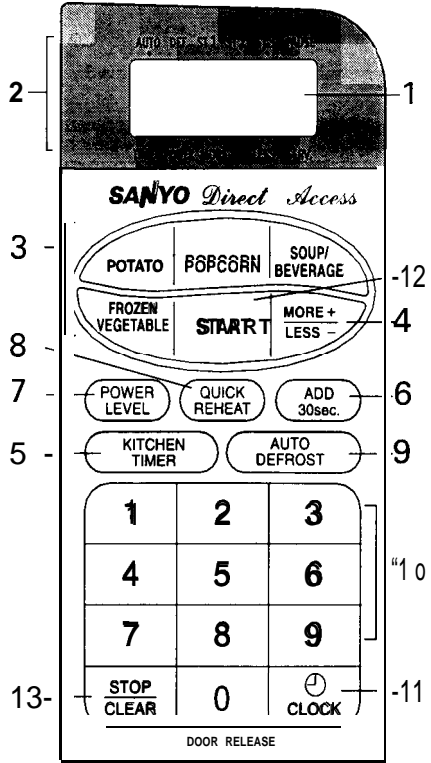
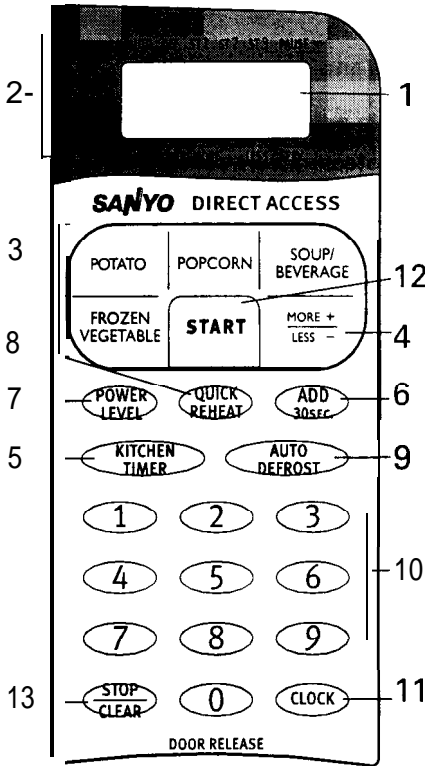





CONTROL PANEL AND FEATURES (CONT.)

- (1) **Display Window**
Shows cooking time in seconds during cooking. Shows clock time when oven is not in use,
- (2) **Indicators**
AUTO: Lights during Direct Access microwaving.
DEF.: Lights during Auto Defrost.
PAUSE: Flashes to alert you to rearrange food during Auto Defrost process.
ST1/ ST2/ ST3: Lights to indicates current cooking stage.
TIME: Lights to indicate the time has been entered.
POWER: Lights to indicate the power level has been selected,
MORE/LESS: Lights to indicate MORE/LESS adjustment has been entered.
SERV.: Lights to indicate the number of serving has been entered.
Kg/g: Flashes to prompts you to enter food weight for Auto Defrost. Lights when weight has been entered,
- (3) **Direct Access keypads (page 15)**
- (4) **MORE/LESS**
Adds or reduces cooking time for Direct Access menu keypads
- (5) **KITCHEN TIMER (page 13)**
- (6) **ADD 30 SEC. (page 13)**
- (7) **POWER LEVEL (page 14)**
- (8) **QUICK REHEAT (page 18)**
- (9) **AUTO DEFROST (page 16)**
- (10) **Number keys**
- (I I) **CLOCK (page 12)**
- (12) **START**
- (13) **STOP/CLEAR**
Clears all previous setting if pressed before cooking starts. During cooking: press once to stop oven; twice to stop and clear all entries,
- Beep Sound**
A beep sounds when a keypad is pressed, to confirm your key entry.

SETTING CLOCK

To set the time of day, follow the steps below.

Example: To set 3:15:

1	Press CLOCK .	
2	Press 3 , 1 and 5 to enter time of day.	  
3	Press CLOCK . The clock starts counting.	

Note: • If the clock (or display) shows any abnormality, unplug the oven from the AC outlet. Plug it in again and then reset the clock.

- When your oven is plugged in for the first time or when power resumes after a power interruption, the numbers in the display reset to 0:00
- This is a 12-hour clock,
- You can use the oven without setting clock.

CHILD LOCK-OUT

The oven has a safety feature which prevents use by children. The feature locks the operation of the oven until cancelled.

To set:

1	Press START and hold for 4 seconds. L appears in the display.	
----------	---	---





To cancel:

1	Press START and hold for 4 seconds. L disappears from the display,	
----------	--	---

KITCHEN TIMER

You can use the Kitchen Timer function independently, even while a cooking program is going on in the oven.

Example: To set timer for 3 minutes:

1	Press KITCHEN TIMER.	
2	Press 3, 0 and 0 to set 3 minutes. (up to 99 minutes 99 seconds)	  
3	Press START. The timer starts counting and beeps for 7 seconds at the end.	

- Note:**
- After pressing KITCHEN TIMER, you have 10 seconds to enter time. or the setting will be cleared with a beep,
 - Press STOP/CLEAR to clear or change a Kitchen Timer setting,
 - When cooking or defrosting time appears with a flashing letter K in the display, this indicates that the Kitchen Timer is in operation,
 - A steady letter K in display indicates that only the Kitchen Timer is in use.
 - To check remaining time on Kitchen Timer during cooking/defrosting, press KITCHEN TIMER, The remaining time will appear in the display for 5 seconds.
 - To stop Kitchen Timer beeping, press KITCHEN TIMER.
 - If oven and Kitchen Timer stop at the same time, only the oven will beep.
 - If cooking completes while you are setting the Kitchen Timer, all settings are cleared. Restart from step 1.
 - After entering time in step 2, Kitchen Timer will automatically begin after 5 seconds if START is not pressed,



OPERATION

ADD 30 SECONDS

This feature provides 2 functions:

- Allows you to cook for only 30 seconds on P100 (maximum power).
- Allows you to extend a cooking time by 30 seconds during Time Cooking without pressing START. You can repeat this option up to 3 times.



Example: To set 30-second cooking:

1	Press ADD 30 SEC. once.	
2	Press START. The display shows time countdown.	

Note: This feature cannot be used during Direct Access Cooking or Auto Defrost by weight,

TIME COOKING

This basic microwave cooking method allows you to cook food for a desired time. The oven can be programmed to cook for up to 99 minutes 99 seconds. In addition to the maximum power level (P100), you can select different microwave power from 10 levels, P 0 to P90 (0-90% of total power level). Example: To cook at power level P80 for 40 seconds:

1	Enter 40 seconds by pressing 4 and 0.	
2	Press POWER LEVEL until P80 appears in the display.	
3	Press START.	

- Note:**
- If no power level is entered, the power level will always be P100 (100%),
 - Foods with high moisture content should be cooked on P100 power.
 - To check the power level during cooking, press POWER LEVEL.

POWER LEVEL SETTING GUIDE

<p>P100 •Cooking poultry, vegetables, and most casseroles. Boiling water.</p> <p>•Preheating a browning dish.</p>	<p>P50 Medium</p> <p>•Cooking custards and pasta</p> <p>•Cooking rump roast, ham, veal, lamb.</p>
<p>P90 •Reheating rice and pasta,</p>	<p>P40 •Cooking less tender cuts of meat in liquid or slow-cooking dishes.</p> <p>•Completing the cooking cycle of less tender roasts.</p>
<p>P80 •Reheating precooked or prepared food quickly.</p> <p>•Cooking fish.</p>	<p>P30 Med. Low</p> <p>•Completing the cooking cycle of casseroles, stews, sauces.</p> <p>•Time defrosting.</p>
<p>P70 Med. High</p> <p>•Cooking cheese dishes</p>	<p>P20 •Softening chocolate</p> <p>•Clarifying butter.</p> <p>•Heating breads, rolls, pancakes, tacos, tortillas, French toast,</p>
<p>P60 •Cooking scrambled eggs.</p> <p>•Baking cakes.</p>	<p>P10 •Softening cream cheese, butter.</p> <p>•Keeping casseroles warm.</p>

Time Defrosting:

Use power level P30 (Medium Low). For most frozen foods, allow approximately 5 minutes per 500g. To speed up the defrosting of dense foods over 500g, you may start on P100 for 2 minutes. Then reduce to the power level P30 and enter remaining time.

Multistage Cooking:

You can program oven for 3 cooking stages. Each stage can be programmed with a different power level and time. To program 2-stage or 3-stage cooking, repeat the Time Cooking steps 1 and 2 and press START. The oven will automatically proceed to the end of cooking stages.



Delay Start Cooking:

You can delay the time when you want cooking to start, Cooking can be delayed up to 99 minutes and 99 seconds. To delay cooking, follow procedure for multistage cooking, but for stage1 use power level P0.

DIRECT ACCESS COOKING

Direct Access Cooking allows you to reheat or cook food automatically without entering power level or time. Choose the appropriate food keypad 1 -3 times, depending on the serving size, and press START.

Example: To cook 1 baked potato:

1	Press POTATO once.	
2	Press START. The time counts down in the display.	

Direct Access Cooking serving sizes:

Food Keypad	Press Food Keypad		
	once	twice	3 times
POTATO	1 serving (170 g)	2 servings (340 g)	3 servings (510 g)
POPCORN	100g	85 g	50 g
SOUP/BEVERAGE	1 serving (230 mL)	2 servings (460 mL)	3 servings (690 mL)
FROZEN VEGETABLE	1 serving (150 g)	2 servings (300 g)	3 servings (450 g)

OPERATION

MORE/LESS TIME ADJUSTMENT

The MORE/LESS keypad allows fine adjustments in Direct Access Cooking by either increasing or decreasing the preprogrammed cooking time.

You can change the cooking time by pressing MORE/LESS key once or twice before pressing START.

To increase the time, press MORE/LESS once, and press START.

To decrease the time, press MORE/LESS twice, and press START

COOKING/REHEATING TIPS

POTATO

- Arrange in a circular pattern with heavier ends pointing toward the outer edge of the dish. Rotate and turn over during cooking.

POPCORN

- Do not use this feature if popcorn bag size is not 100g, 85g or 50g.
- Do not leave the oven unattended when popping popcorn.
- Supervise children closely.

CAUTION:

- 1) Pop only one bag at a time.
- 2) Do not reheat unpopped kernels or reuse bag, Overcooking can result in an oven fire.
- 3) Never use a brown paper bag for popping corn.
- 4) After popping, open bag carefully as popcorn and steam are extremely hot.

SOUP/BEVERAGE

- Soups or beverages must be at room or refrigerator temperature for reheating.

FROZEN VEGETABLE

- Follow package directions for venting package, adding water, piercing pouch, replacing foil, covering with plastic wrap, etc.

DIRECT ACCESS COOKING (CONT.)





Direct Access Cooking/Reheating Guide

Item	Special Notes
Potato	Wash and scrub well. Pierce with fork. Place on paper towel. Turn over during cooking. Let stand 3-5 minutes. Do not place in centre of turntable.
Popcorn (100g,85g,50g)	Unfold the bag and place in oven according to directions.
Soup/Beverage	Coffee/Tea/Hot Chocolate: No cover. Stir after reheating. Soup: Cover. Stir after reheating.
Frozen Vegetable	Place in a suitable sized microwave-safe dish. Cover. Stir during cooking. Let stand 2-3 minutes.

AUTOMATIC DEFROST BY WEIGHT

Automatic Defrost allows you to easily defrost food. Power levels and times are automatically determined when the food weight is entered.

Example: To defrost a 2.5 kg whole chicken:

1	Press AUTO DEFROST.	
2	Enter the weight of food in kilogram.	 
3	Press START. Total defrost time appears in the display.	

Defrosting Techniques:

- Remove freezer paper, plastic wrap or foil wrap. Place food in a microwave-safe dish.
- To prevent thin parts and edges from becoming too warm and cooking before centre of food is defrosted, shield with small pieces of aluminium foil.
- Because some foods will still be icy in the centre, it is necessary to have a standing time after defrosting the food in the oven. Food should be taken out of the oven to complete defrosting. A longer standing time might be required for denser foods such as roasts.
- To defrost items not listed in defrosting chart, use Time defrosting (see page 14).

Note: • Maximum weight for defrosting is 2.9kg.

- The oven selects 1 kg if a weight is not entered.
- Beep tone sounds 5 times during the defrosting cycle to signal that food should be rearranged to improve defrosting performance. Open the door and rearrange the food. The oven continues the defrosting cycle to the end if you do not open the door.
- Food can be defrosted in a styrofoam package.
- If weight of food is stated in pounds and ounces, it must be converted to kilograms.

AUTOMATIC DEFROST BY WEIGHT (CONT.)

Conversion Table

lbs - oz.	kg	lbs - oz.	kg
4 oz.	0.1	3 lb-9 oz.	1.6
7 oz.	0.2	3 lb-12 oz.	1.7
10 oz.	0.3	4 lb	1.8
14 oz.	0.4	4 lb-3 oz.	1.9
1 lb-2 oz.	0.5	4 lb-7 oz.	2.0
1 lb-5 oz.	0.6	4 lb-10 oz.	2.1
1 lb-9 oz.	0.7	4 lb-14 oz.	2.2
1 lb-12 oz.	0.8	5 lb-1 oz.	2.3
2 lb	0.9	5 lb-5 oz.	2.4
2 lb-4 oz.	1.0	5 lb-8 oz.	2.5
2 lb-7 oz.	1.1	5 lb-12 oz.	2.6
2 lb-11 oz.	1.2	5 lb-15 oz.	2.7
2 lb-14 oz.	1.3	6 lb-3 oz.	2.8
3 lb-2 oz.	1.4	6 lb-6 oz.	2.9
3 lb-5 oz.	1.5		

DEFROSTING CHART



Item	During Defrosting
Beef	
Ground beef	Turn over. Remove defrosted portion.
Liver	Drain liquid. Separate pieces.
Roasts	Turn over. Cover ends with foil.
Sirloin steak	Turn over.
Rib or T-bone	Turn over.
Flank steak	Turn over.
Stewing meat	Break apart.
Pork	
Ground pork	Turn over. Remove defrosted portion.
Bacon	Defrost in original wrapper. Turn over.
Chops	Separate and turn over.
Ribs	Turn over.
Roasts	Turn over. Cover ends with foil.
Lamb	
Ground lamb	Turn over. Remove defrosted portion.
Chops	Separate. Turn over.
Ribs	Turn over.
Roasts	Turn over. Cover ends with foil.
Poultry	
Chicken, whole	Turn over. Cover ends with foil. Rinse under cold water after defrosting.
Pieces	Separate. Turn over.
Cornish hens	Turn over. Cover ends with foil. Rinse under cold water after defrosting.
Fish and Seafood	
Crabmeat, Shrimp	Break apart.
Fish fillets	Turn over. Rearrange. Rinse under cold water to separate after defrosting.
Fish whole	Turn over. Cover head and tail with foil.
Steaks	Turn over.
Scallops	Break apart. Remove defrosted seafood.

OPERATION

QUICK REHEATING

A time-saving feature, this simplified control lets you quickly set and start microwave cooking without pressing START.

Example: To set Quick Reheating for 2 minutes:

1	Press QUICK REHEAT,	
2	Press 2. The display shows time counting down.	

Note: • To cook for 30 seconds, press 0. To cook for 1 to 9 minutes, press the corresponding number key (1 - 9).

• This feature only cooks at highest power level (P100).

QUICK REHEATING AND COOKING CHART

Reheating	Amount	Time	Special Notes
Meat			Place in microwave-safe dish.
Chili, stews	2 cups	3-4 min.	Cover. Stir halfway through cooking time.
Hamburgers, meat loaf slices	1 serving	1/2 - 1 min.	Place on microwave-safe plate.
	2 servings	1 - 2 min.	Cover with paper towel. Turn over once.
Poultry			Heat on microwave-safe plate.
Chicken pieces	2	1 - 2 min.	Cover with wax paper. If fried, cover with paper towel.
	4	2-3 min.	
Chicken, turkey, sliced	85-140 g	1 - 2 min.	Heat on microwave-safe plate. Cover with wax paper.
Cooked rice, pasta	1 cup (250 mL)	1-2 min.	Heat in microwave-safe casserole, covered with plastic wrap.
	2 cups (500 mL)	2-3 min.	
Canned vegetable	230 g	1 - 2 min	Use microwave-safe casserole, covered. Stir once.
	425 g	2-3 min.	
Cooking	Amount	Time	Special Notes
Mashed potatoes instant	4 servings	3 - 5 min.	Follow package directions. Reduce liquid by 1 tbsp (15 mL).
Pudding and pie filling mix	90 g	4-6 min.	Follow package directions. Stir once.
Cereals			Add 3/4 cup (175 mL) of water.
Cream of wheat (regular)	1/2 cup (50 mL)	1 - 2 min.	Cook uncovered. Stir once. Let stand for 1 minute.

OPERATING INSTRUCTIONS FOR EM-MI07

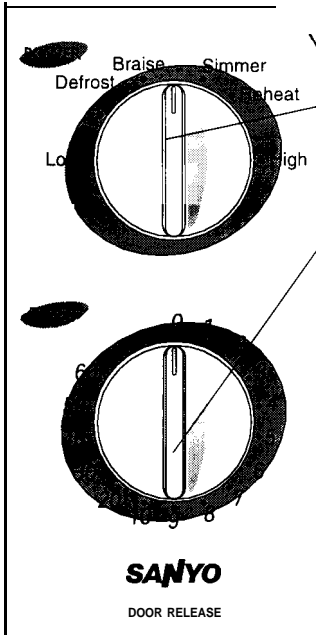

1. Open the door and place the food on the turntable in the oven. Then shut the door
2. Set the Variable **POWER** selector to the desired power level.
3. Set the **TIMER** to the desired time. The oven begins cooking. A single ring will sound at the end of the set time and the oven will turn off.

Note:

- When cooking for less than 2 minutes, turn the **TIMER** for a longer period and then return to the desired time,
- To turn off the oven during cooking, simply turn the timer to **0**; otherwise the microwave will continue to operate.
- After use, be sure to return the timer to **0** or the oven will continue to operate.

POWER SETTING GUIDE

Power Level	Cooking Example
LOW	<ul style="list-style-type: none"> • Softening cream cheese. • Keeping foods warm.
DEFROST	<ul style="list-style-type: none"> • Thawing meat, poultry and seafood.
BRAISE	<ul style="list-style-type: none"> • Cooking less tender cuts of meat in liquid or slow cooking dishes. • Completing the cooking cycle of less tender roasts.
SIMMER	<ul style="list-style-type: none"> • Baked custards and cheese cakes. • Roasting meats.
REHEAT	<ul style="list-style-type: none"> • Baking cakes, • Reheating precooked food.
HIGH	<ul style="list-style-type: none"> • Boiling liquids. • Cooking fish, vegetables. • Preheating a browning dish.

MAINTENANCE

TROUBLESHOOTING

Check your problem by using the chart below and try the solutions for each problem. If the microwave oven still does not work properly, contact the nearest authorized service center

TROUBLE	POSSIBLE CAUSE	POSSIBLE REMEDY
Oven will not start.	<ul style="list-style-type: none"> •Electrical cord for oven is not plugged in. •Door is open. •Wrong operation is set. 	<ul style="list-style-type: none"> •Plug into the outlet. •Close the door and try again. •Check instructions, (pages 12-19)
Arcing or sparking.	<ul style="list-style-type: none"> •Materials to be avoided in microwave oven are used. •The oven is operated when empty. •Spilled food remains in the cavity. 	<ul style="list-style-type: none"> •Use microwave-safe cookware only. (page 7) •Do not operate with oven empty. •Clean cavity with wet towel.
Unevenly cooked foods.	<ul style="list-style-type: none"> •Materials to be avoided in microwave oven are used. • Food is not defrosted completely. •Cooking time, power level is not suitable. •Food is not turned or stirred. 	<ul style="list-style-type: none"> •Use microwave-safe cookware only. (page 7) •Completely defrost food. •Use correct cooking time, power level. •Turn or stir food.
Overcooked foods.	<ul style="list-style-type: none"> •Cooking time, power level is not suitable. 	<ul style="list-style-type: none"> •Use correct cooking time, power level.
Undercooked foods.	<ul style="list-style-type: none"> •Materials to be avoided in microwave oven are used. •Food is not defrosted completely. •Oven ventilation ports are restricted. •Cooking time, power level is not suitable. 	<ul style="list-style-type: none"> •Use microwave-safe cookware only. (page 7) •Completely defrost food. •Check to see that oven ventilation ports are not restricted. •Use correct cooking time, power level.
Improper defrosting.	<ul style="list-style-type: none"> •Materials to be avoided in microweve oven are used. •Cooking time, power level is not suitable. •Food is not turned or stirred. 	<ul style="list-style-type: none"> •Use microwave-safe cookware only. (page 7) •Use correct cooking time, power level. •Turn or stir food.
E (error) message appears in the display.	<ul style="list-style-type: none"> •Wrong operation is set. 	<ul style="list-style-type: none"> •Check instructions, (pages 12-19)

QUESTIONS AND ANSWERS

- Q. When the oven is plugged into a wall outlet for the first time, it does not work properly. What is wrong?
- A. The microcomputer used in the oven control may temporarily become scrambled and fail to function as programmed. Unplug the oven from the wall outlet and then plug it back in. The microcomputer will then reset for proper functioning.
- Q. Why is there noise coming from the turntable when the oven is turned on?
- A. This noise occurs when the turntable roller rest and cavity bottom are dirty. Clean the turntable roller rest cavity bottom. Frequent cleaning of these parts should eliminate or reduce the noise.
- Q. Why is there noise coming from the oven when using a lower power level?
- A. When cooking with power other than High or P100, the oven automatically turns on and off to obtain lower power output. The clicking noise can be heard when the oven switches on and off. This is normal.
- Q. Why is there steam coming out of the air exhaust vent?
- A. Steam is produced during cooking. The microwave oven has been made to vent this steam.
- Q. What is wrong when the oven light will not glow?
- A. There may be several reasons why the oven light will not glow. The light bulb has burned out or START (EM-N108, N202) has not been pressed.
- Q. Why do eggs sometimes pop?
- A. The egg yolk may pop because of steam build-up inside the membrane. Pierce the membrane with a toothpick before cooking it. Never microwave eggs in the shell since they may explode.
- Q. How are boil-overs avoided?
- A. Use a larger utensil than usual for cooking. If you open the oven door or touch STOP/CLEAR (EM-N108, N202), the food will stop boiling.

CLEANING

Wipe the oven inside and outside with a soft cloth and a mild detergent solution. Then rinse and wipe dry. This should be done on a weekly basis, more often if needed. Never use cleaning powders or rough pads. Excessive oil splatters on the inside top will be difficult to remove if left for many days. Wipe splatters with a wet paper towel, especially after cooking chicken or bacon.

REMOVABLE PARTS

The following parts may be removed as described. They should be washed in warm (not hot) water with a mild detergent and a soft cloth. Once they are clean, rinse them well and dry with a soft cloth. Never use cleaning powders, steel wool or rough pads.

- The turntable may be cleaned at the sink, Be careful not to chip or scratch the edges as this may cause the turntable to break during use.
- The turntable roller rest should be cleaned regularly.

SPECIAL CARE

For best performance and safety, the inner door panel and the oven front frame should be free of food or grease buildup. Wipe them often with a mild detergent. Then rinse and wipe dry. Never use cleaning powders or rough pads

After cleaning the control panel, press STOP/CLEAR (EM-N108, N202) to clear any entries that might have been entered accidentally while cleaning the panel.

QUICK REFERENCE FOR EM-N108/N202

DIRECT ACCESS COOKING

1. Press
POTATO,
POPCORN,
SOUP/BEVERAGE or
FROZEN VEGETABLE,
1 -3 times until desired number of
servings appears.
 2. If desired, press MORE/LESS once
or twice.
Press once for increased cooking
time.
Press twice for decreased cooking
time.
 3. Press START.
-

CHILD LOCK-OUT

To set:

1. Press and hold START for
4 seconds, Indicator L lights.

To cancel:

1. Press and hold START for
4 seconds. Indicator L disappears.
-

QUICK REHEATING

(Hi-power only)

1. Press QUICK REHEAT
2. Press a number (0-9) for cooking
time.

NOTE: To set Quick Reheating for 30
seconds, press QUICK REHEAT and 0.

TIME COOKING

1. Press numbers for cooking time (in
minutes and seconds).
 2. Press POWER LEVEL until desired
power level (P100 - P 0) appears in
the display.
 3. Press START
-

AUTO DEFROST

1. Press AUTO DEFROST
2. Enter the weight of food in kg.
3. Press START
4. At pause, rearrange food.
5. Press START to restart.

NOTE: If you do not open the door at
the Pause, the oven continues to
complete the defrosting.

CLOCK

1. Press CLOCK.
 2. Press numbers to set time.
 3. Press CLOCK.
-

KITCHEN TIMER

1. Press KITCHEN TIMER.
 2. Press numbers for desired time
 3. Press START
-

ADD 30 SECONDS

1. Press ADD 30 SEC.
2. Press START.

NOTE: If you use ADD 30 SEC. while
cooking, you do not need to press
START. You can use ADD 30 SEC. up
to 3 times while oven is in operation.

S* O

SANYO Electric Co., Ltd.

8/99 Printed in Singapore

Code No. 432-6-414S-75600