



INSTRUCTION MANUAL

EM-N200

Microwave Oven

TABLE OF CONTENTS

Safety Instructions

■ PRECAUTIONS TO AVOID POSSIBLE EXPOSURE TO EXCESSIVE MICROWAVE ENERGY	1
■ Important Safety Instructions	2

Setting Up & Getting to Know Your Oven

■ Earthing Instructions	3
■ Installation	3
■ Names of Oven Parts and Accessories	4
■ Control Panel and Features	5
■ Setting Clock	6
■ Child Lock-Out	6
■ Utensils	7

Operating Instructions

■ Automatic Popcorn	8
■ Quick-Reheat Cooking	8
■ Automatic Defrost by Weight	9
■ Direct Access Cooking	10
■ Time Cooking	11
■ Minute Timer	12
■ Multistage Cooking	12

Care of Your Microwave Oven

■ Questions and Answers	13
■ Cleaning	14
■ Before Calling for Service	14

Charts

■ Quick-Reheat Cooking Chart	15
■ Automatic Defrost Chart	16

Quick Reference. back cover

Read these instructions carefully before using these ovens. If you follow the instructions, your microwave oven will provide you with many years of good service.

SAVE THESE INSTRUCTIONS

SPECIFICATIONS

Model	EM-N200
Power Consumption	1150W
Maximum Output	750W*
Oven Capacity	17.0 L
Turntable Diameter	275 mm
Dimensions (w x h x d)	461 mm x 250 mm x 346 mm
Weight (Approx.)	12.5 kg

*According to IEC-705 test procedures.

Specifications subject to change without notice.

PROPER AND SAFE USE OF YOUR OVEN

- The oven must be level.
- The turntable and turntable roller rest must be in the oven during cooking.
- Place the cookware gently on the turntable and handle it carefully to avoid possible breakage.
- The oven has several built-in safety switches to ensure that the power remains off when the door is open. Do not tamper with these switches.
- Do not operate the microwave oven empty.
- Do not overcook food. A small quantity of food with low moisture content or high fat or sugar content can burn.
- Do not cook bacon directly on the turntable. Excessive local heating of the turntable may cause it to break.
- Avoid heating baby bottles or baby food jars. Transfer the food into a suitable container for the microwave oven. The food temperature should be tested before giving it to the baby.
- Do not heat narrow-necked containers, such as syrup bottles.
- Do not attempt to deep-fry in your microwave oven as the temperature of oil cannot be controlled.
- Do not heat cans. Transfer the contents into a microwave-safe dish before heating.
- Do not use this microwave oven for commercial purposes. This microwave oven is made for household use only.

NOTE

- It is quite normal for steam to be emitted around the door, for misting to occur on the door, or even for water droplets to appear below the door during the cooking cycle. This is merely condensation from the heat of the food.

PRECAUTIONS TO AVOID POSSIBLE EXPOSURE TO EXCESSIVE MICROWAVE ENERGY

- (a) Never interfere or tamper with safety interlocks.
- (b) Do not place any object between the oven front face and the door or allow soil or cleaner residue to accumulate on door sealing surfaces. Wipe the door sealing area frequently with a mild detergent, rinse and wipe dry. Never use abrasive powders or pads.
- (c) When open, the door must not be subjected to strain; for example, a child hanging on the opened door or any load on it could cause the oven to fall forward, and the weight could also damage the door.
- (d) Do not operate the oven if it is damaged. It is particularly important that the oven door closes properly and that there is no damage to the:
 - (1) DOOR (bent)
 - (2) HINGES AND LATCHES (broken or loosened)
 - (3) DOOR SEALS AND SEALING SURFACES

IMPORTANT SAFETY INSTRUCTIONS

When using electrical appliances, basic safety precautions should be followed, including the following:

WARNING – To reduce the risk of burns, electric shock, fire, injury to persons or exposure to excessive microwave energy:

1. **Read all instructions before using.**
2. As with most cooking appliances, close supervision is necessary to reduce the risk of a fire in the oven cavity.

If a fire should start:

- Keep the oven door closed
- Turn the oven off, and
- Disconnect the power cord or shut off power at the fuse or circuit breaker panel.

Keep in mind the following rules at all times:

- a. Do not overcook food. Overcooked food can cause fires in the oven. Carefully attend to the oven's activities, especially if paper, plastic, or other combustibles are inside.
 - b. Do not store combustible items such as bread, cookies, paper products, etc. inside the oven. They may catch fire if turned on accidentally.
 - c. Do not use wire twist-ties in the oven. Be sure to inspect purchased items for wire twist-ties and remove before placing food in the oven.
3. Some products such as eggs in the shell, water with oil or fat, sealed containers and closed glass jars may explode and therefore should not be heated in this oven.
 4. Use this oven only for its intended uses as described in the manual. It is not designed for industrial or laboratory use. Never use corrosive chemicals or vapours in this oven.
 5. As with any appliance, children should use the oven only under adult supervision.
 6. Do not store or use this appliance outdoors.
 7. Keep the oven away from heat and water sources. Exposure to heat and water can lower efficiency and lead to malfunctioning.
 8. When heating water or other liquids, use a wide necked container to allow air bubbles to escape freely. Using narrow-necked containers may cause the liquid to boil over. This may happen even after the cooking has stopped.
 9. It is important to keep the door and the oven interior clean.
(See "Cleaning" instructions on page 14.)

WARNING

- (a) Do not adjust or repair microwave oven yourself. Do not operate the oven if it is damaged, until it has been repaired by a service engineer trained by the manufacturer.
- (b) It is dangerous for anyone other than a properly qualified engineer trained by the manufacturer to carry out adjustments or repairs.
- (c) If the power supply cord is damaged, it must be replaced by the manufacturer, as a specially prepared cord is required.
- (d) On no account remove or interfere with any parts or screws.
THIS COULD PROVE VERY DANGEROUS.

SAVE THESE INSTRUCTIONS

EARTHING INSTRUCTIONS

This appliance must be earthed. If there is an electrical short circuit, earthing reduces the risk of electric shock by providing an escape wire for the electric current. This appliance is equipped with a cord that has a earthing wire with a earthing plug. The plug must be plugged into an outlet that is properly installed and earthed.

The electrical power cord must be kept dry and must not be pinched or crushed in any way.

WARNING - Improper use of the earthing plug can result in electric shock.

INSTALLATION

Remove all packing material and accessories. Examine the oven for any damage such as dents or a broken door. Do not install if oven is damaged.

1. Select a level surface that provides enough open space (see illustration at right) for the inlet and/or outlet vents.
 - Leave a minimum clearance of 7.5 cm above the oven.
 - Do not remove the legs from the bottom of the oven.
 - Blocking the inlet and/or outlet openings can damage the oven.
 - Do not install oven over a range, cooktop or other heat-producing appliance.
 - Place the oven as far away from radios and T.V.'s as possible.
 - When the cabinet is covered with a protective film, remove the film to fully show the intended colour and finish.
2. Plug your oven into a standard household outlet. Be sure that your microwave oven is the only appliance on the circuit.

When installing in a "Built-in" situation, you must allow a minimum of 7.5 cm on each side and the top and at the back of the microwave oven for ventilation. Failing to do so might cause damage to the microwave oven.

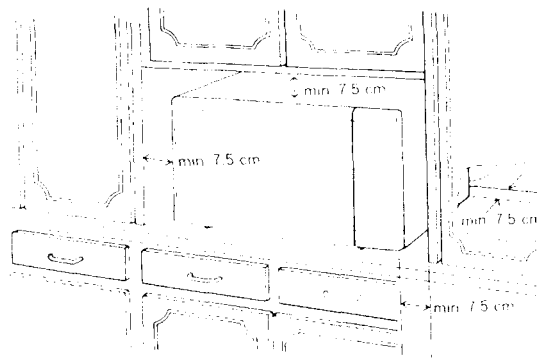

A minimum clearance of 7.5 cm is required between the oven and any adjacent walls including the back wall.

NAMES OF OVEN PARTS AND ACCESSORIES

Remove the oven and all materials from the carton.
Your oven comes with the following accessories:

Turntable	1
Turntable roller rest	1
Instruction Manual	1

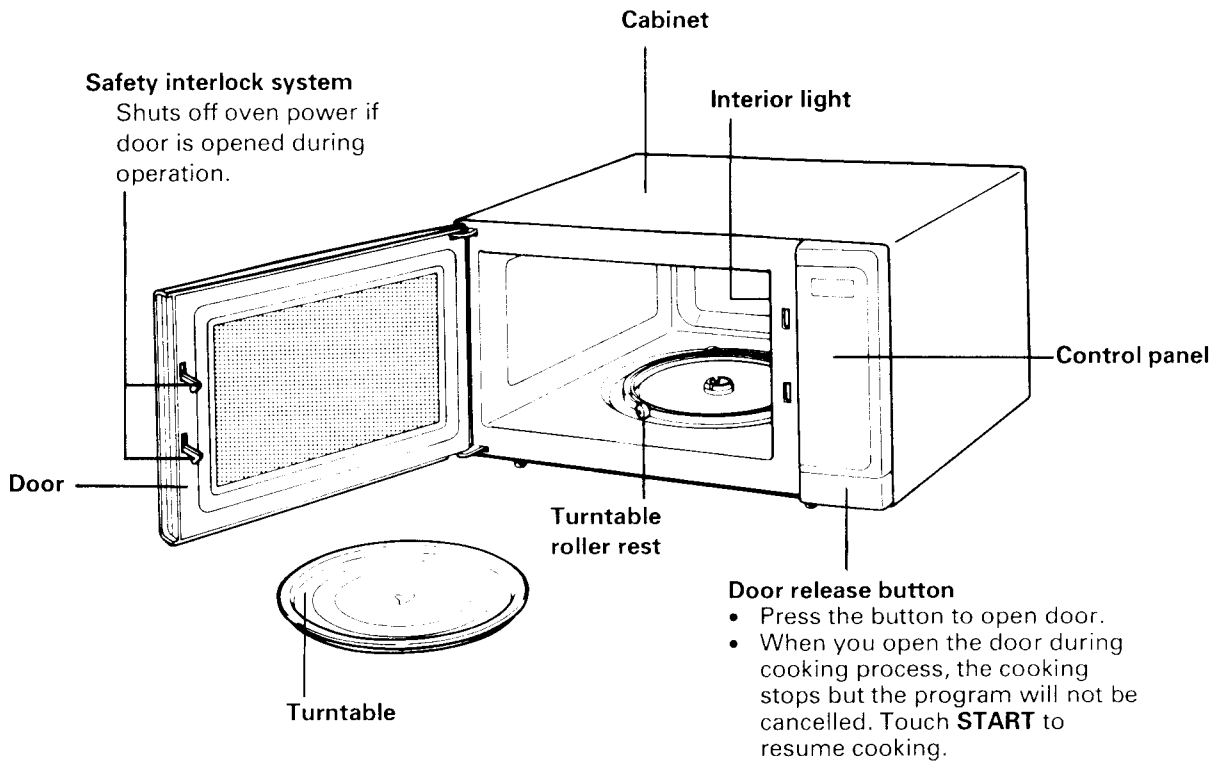

TURNTABLE INSTALLATION

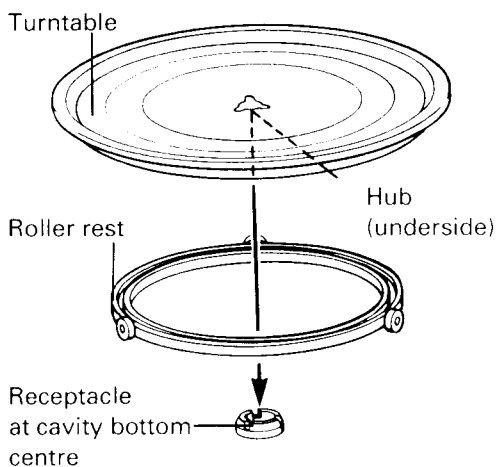

1. Place the roller rest on the cavity bottom.
 2. Place the turntable on top of the roller rest as shown in the diagram. Make sure the turntable hub is securely locked in the receptacle. **Never place the turntable upside down.** The turntable rotation should never be restricted.
- Both turntable and roller rest must always be used during cooking.
 - All food and containers of food are always placed on this turntable for cooking.
 - **This turntable returns to its original starting position** when cooking is finished. The light and fan will remain on but microwave power is turned off.
 - This turntable rotates clockwise or counterclockwise; this is normal.

CONTROL PANEL AND FEATURES

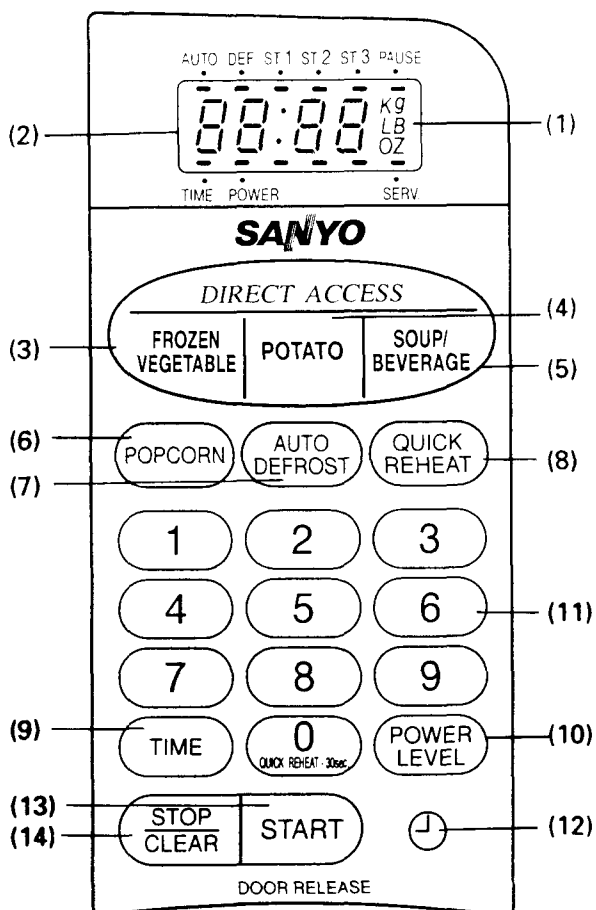

(1) Display Window

Counts down cooking time in seconds during cooking. Shows clock time when oven is not in use.

(2) Indicators

ST1/ ST2/ ST3 : Cooking stage indicators
AUTO/ DEF/ PAUSE : Cooking mode indicators

TIME/ POWER/ SERV./ Kg/ g :

A flashing indicator prompts you to enter desired cooking time, power setting, food weight or number of servings.

Direct Access menu keypads (page 10)

(3) **FROZEN VEGETABLE**

(4) **POTATO**

(5) **SOUP/ BEVERAGE**

Auto menu keypads

(6) **POPCORN** (page 8)

(7) **AUTO DEFROST** (page 9)

(8) **QUICK REHEAT** (page 8)

(9) **TIME keypad** (page 11)

(10) **POWER LEVEL keypad** (page 11)

(11) **Number keypads**

(12) **Clock keypad** (page 6)

(13) **START keypad**

(14) **STOP/CLEAR keypad**

Clears all previous setting if pressed before cooking starts. During cooking: touch once to stop oven; twice to stop and clear all entries.







Beep Sound

A beep tone sounds when a keypad on the control panel is touched to indicate a setting has been entered.

SETTING CLOCK

When your oven is plugged in for the first time or when power resumes after a power interruption, the numbers in the display reset to **0:00**. Set the clock.

Example: To set 3:15 :

1.  Touch .
2.    Touch number keypads **3**, **1** and **5**.
3.  Touch .
The clock starts counting.





Remember:

- If the clock (or display) shows any abnormality, unplug the oven from the AC outlet. Plug it in again and then reset the clock.





CHILD LOCK-OUT

Your oven has a safety feature which prevents children from accidentally turning it on. Even if the oven is accidentally programmed to cook, no cooking takes place when this feature is set.

To set :

1.  Touch .
2.  4 times
Touch **9** four times.
3.  Touch **START**.
Indicator **L** lights and clock display reappears.

To cancel :

1.  Touch .
2.  4 times
Touch **7** four times.
3.  Touch **START**.
Indicator **L** disappears and clock display reappears.

UTENSILS

MATERIALS YOU CAN USE IN MICROWAVE OVEN

Utensils	Use	Remarks
Aluminium foil	Shielding	Small smooth pieces can be used to cover thin parts of meat or poultry to prevent overcooking. Arcing can occur if foil is too close to oven walls. The foil should be at least 2.5 cm away from oven walls. Do not cover food completely with aluminium foil.
Browning dish	Searing meats	Follow manufacturer's instructions. The bottom of browning dish must be at least 5 mm above the turntable. Incorrect usage may cause the turntable to break.
Dinnerware	Reheating and short-term cooking	Microwave-safe only. Follow manufacturer's instructions. Do not use cracked or chipped dishes.
Glass jars	Warming	Always remove lid. Use only to heat food until just warm. Most glass jars are not heat resistant and may break.
Glassware	Cooking	Heat-resistant oven glassware only. Make sure there is no metallic trim. Do not use cracked or chipped dishes.
Oven cooking bags	Cooking	Follow manufacturer's instructions. Do not close with metal tie. Make slits to allow steam to escape.
Paper plates and cups	Short-term warming and cooking	Use for short-term cooking/warming only. Do not leave oven unattended while cooking.
Paper towels	Reheating and short-term cooking	Use to cover food for reheating and absorbing fat. Use with supervision for a short-term cooking only.
Parchment paper	Cooking	Use as a cover to prevent spattering or a wrap for steaming.
Plastic	Reheating and short-term cooking	Microwave-safe only. Follow the manufacturer's instructions. Should be labeled "Microwave Safe." Some plastic containers soften as the food inside gets hot.
Plastic wrap	Cooking	Microwave-safe only. Use to cover food during cooking to retain moisture. Do not allow plastic wrap to touch food.
Thermometers	Cooking	Microwave-safe only (meat and candy thermometers).
Wax paper	Cooking	Use as a cover to prevent spattering and to retain moisture.

MATERIALS TO BE AVOIDED IN MICROWAVE OVEN

Utensils	Remarks
Aluminium tray	Aluminium tray may cause arcing. Transfer the food into a microwave-safe dish before cooking.
Food carton with metal handle	May cause arcing. Transfer food into microwave-safe dish.
Metal or metal-trimmed utensils	Metal shields the food from microwave energy. Metal trim may cause arcing.
Metal twist ties	They may cause arcing and could cause a fire in the oven.
Paper bags	May cause a fire in the oven.
Plastic foam cups	Plastic foam may melt or contaminate the liquid inside when exposed to high temperature.
Wood	Wood will dry out when used in the microwave oven and may split or crack.

UTENSIL TEST: Fill a microwave-safe container with 1 cup of cold water (250 mL) and place it in the oven along with the utensil in question. Cook on HI power for 1 minute. Carefully feel the utensil. If the empty utensil is warm, it should not be used for microwave cooking. **Do not exceed 1 minute testing time.** This test cannot be used for plastic containers.

CAUTION:

Make sure that closed containers are opened and plastic pouches pierced before cooking. Tightly-closed utensils could explode.

AUTOMATIC POPCORN

This feature lets you pop a 100-g, 85-g or 50-g prepackaged microwave popcorn quickly and easily.

Popcorn Popping Tips:

- Microwave popcorn bag should be at room temperature.
- Place only one bag in the oven at a time. Follow package instructions. Do not increase quantity.
- Popcorn popping devices are not recommended for use with this feature.

Example: To pop one bag of 100-g microwave popcorn:

1.



Touch **POPCORN** once.
Display shows bag size.
Select bag size as follows.

Bag Size	Touch POPCORN
100 g	once
85 g	twice
50 g	3 times

2.



Touch **START**.
The display shows the time counting down.

Remember:

- If popcorn bag size is not 100 g, 85 g or 50 g, do not use this feature. Follow instructions on the package.
- Do not leave the oven unattended while the corn is being popped.
- Remember to supervise children closely.

CAUTION:

- After popping, open bag carefully. Popcorn and steam are extremely hot.
- Do not reheat unpopped kernels or reuse bag. Overcooking can result in an oven fire.
- Never use a brown paper bag for popping corn.

QUICK-REHEAT COOKING (HI-POWER)

This simplified control lets you set and start microwave cooking for one of 10 predetermined periods of time by just pressing 2 keypads. The power level is always set to **HI** (maximum power) for Quick-Reheat cooking.

- Press the **QUICK REHEAT** keypad and then the **0** key to cook for 30 seconds.
- Press the **QUICK REHEAT** keypad and any other number key (**1 - 9**) to select a cooking time in minute. (To cook for 9 minutes, for example, press the **9** key.)

Example: To set Quick-Reheat cooking 2 minutes:

1.



Touch **QUICK REHEAT**

2.



Touch **2**.
The oven begins cooking and display shows time counting down.

Remember:

- You may open the door to stop cooking before the selected time is over. To start again, close the door and touch **START**.

AUTOMATIC DEFROST BY WEIGHT

The Auto Defrost by Weight feature is an accurate defrosting method for frozen food up to 2.9 kg. The oven automatically selects 1 kg. If food weight is more or less than 1 kg, enter the weight using the number keypads.

Pause Reminder

For the best results, microwave defrosting requires rearranging the food about halfway through the process. A **pause reminder** mechanism is built into this feature to alert you with five beeps to open the door and check, separate or turn the food. The **PAUSE** indicator also flashes for five seconds. If you do not open the door at the pause reminder, the oven continues to complete the defrosting.



Auto Defrosting chart appears on page 16.

For manual defrosting using Time Cooking, see page 11.

Defrosting Tips:

- Check the food during defrosting.
- Remove frozen food from its original paper or plastic wrap. When it is difficult to remove the wrap, defrost the food in the wrap until the pause. At the pause, remove the wrap.
- Place foods in a flat microwave-safe baking dish or roasting rack to catch drippings.
- Food should still be somewhat icy in the centre when removed from the oven.
- The Auto Defrost menu includes standing time.
- Food can be defrosted in a styrofoam package.

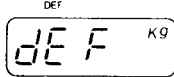
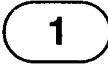
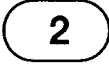
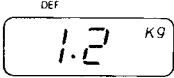
Example: To defrost 1.2 kg of chicken pieces:

1.  Touch **AUTO DEFROST**. 
2.   Enter the weight by touching **1** and then **2**. 
3.  Touch **START**. The oven starts and the defrost time counts down in the display.
4. When the five-beep Pause Reminder sounds, open the door to separate, rearrange or turn food over.
5.  Touch **START** to resume defrosting.

Remember:

- To enter a weight of less than 1 kg, always press **0** first. For example, to enter 0.2 kg, press **0** and then **2**.
- Only one digit can be entered after a decimal point. If in doubt, convert to the lower number.

CONVERSION TABLE					
lbs - oz	grams	kg	lbs - oz	grams	kg
4 oz	100	0.1	3 lb-9 oz	1600	1.6
7 oz	200	0.2	3 lb-12 oz	1700	1.7
10 oz	300	0.3	4 lb	1800	1.8
14 oz	400	0.4	4 lb-3 oz	1900	1.9
1 lb-2 oz	500	0.5	4 lb-7 oz	2000	2.0
1 lb-5 oz	600	0.6	4 lb-10 oz	2100	2.1
1 lb-9 oz	700	0.7	4 lb-14 oz	2200	2.2
1 lb-12 oz	800	0.8	5 lb-1 oz	2300	2.3
2 lb	900	0.9	5 lb-5 oz	2400	2.4
2 lb-4 oz	1000	1.0	5 lb-8 oz	2500	2.5
2 lb-7 oz	1100	1.1	5 lb-12 oz	2600	2.6
2 lb-11 oz	1200	1.2	5 lb-15 oz	2700	2.7
2 lb-14 oz	1300	1.3	6 lb-3 oz	2800	2.8
3 lb-2 oz	1400	1.4	6 lb-6 oz	2900	2.9
3 lb-5 oz	1500	1.5			

DIRECT ACCESS COOKING

Each of the three Direct Access Keypads is preprogrammed to cook/reheat a certain food group. You can indicate the quantity of the food (number of the servings) you want to cook by the number of times you press the designated key. The oven determines cooking time and power level accordingly.

FROZEN
VEGETABLE

Use this key to defrost and heat 1 to 3 servings (150 g - 450 g) of frozen precooked vegetables.

POTATO

Use this key to cook 1 to 3 potatoes (170 - 510 g).

SOUP/
BEVERAGE

Use this key to heat 1 to 3 servings (230 mL - 690 mL) of beverage or soup.

Example: To cook 2 servings of potato :

1.

POTATO

Touch **POTATO** twice.

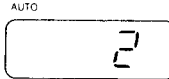

Enter the number of servings by touching a desired menu keypad :

Touch menu keypad	To cook
once	1 serving
twice	2 servings
3 times	3 servings

2.

START

Touch **START**.
The display changes to cooking time countdown.

Cooking Tips

Frozen Vegetable:

- Follow package directions for venting cover, adding water, piercing pouch, replacing foil, covering with plastic wrap, etc.
- Stir during cooking time.

Potato:

- Arrange in a circular pattern with heavier ends pointing toward the outer edge of the turntable.
- Potatoes must be room temperature.
- Turn over during cooking time.

Soup/Beverage:

- Liquids must be room or refrigeration temperature.
- Stir after reheating.

Item	Amount	Directions
FROZEN VEGETABLE	1 serving (150 g) 2 servings (300 g) 3 servings (450 g)	Place in a bowl or dish. Cover. Let stand 2 - 3 minutes.
POTATO	1 potato (170 g) 2 potatoes (340 g) 3 potatoes (510 g)	Pierce with fork. Place on paper towel. Touch menu keypad. Let stand 3 - 5 minutes.
SOUP/BEVERAGE	Coffee/Tea Soup Hot Chocolate	1 serving (230 mL) 2 servings (460 mL) 3 servings (690 mL)
		No cover. Stir after reheating. Cover. Stir after reheating. No cover. Stir after reheating.

NOTE: Use microwave-safe dish, bowl or cup.

TIME COOKING

This basic microwave cooking method allows you to cook food for a desired time. In addition to the **HI** (maximum) power level, you can select different microwave power from 9 levels, **1** (10% of total power) to **9** (90% power) for the foods that require slower cooking. The oven also provides power level **0** (no power) so that the clock can be utilized as a minute timer. See page 12 for details.







Foods with high moisture content should be cooked on maximum power, as this is the fastest cooking method and best maintains the natural flavour and texture of the foods.

To check the power level during cooking, touch **POWER LEVEL**. The power level appears in the display window.

Manual Defrosting

For manual defrosting (without using Auto Defrost features), use power level 3. To speed up the defrosting of dense foods over 450 g, you may start on **HI** for 3 minutes, then reduce to the level 3.

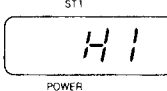
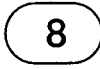
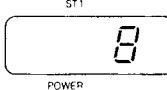
Example: To cook at power level 8 for 40 seconds:

1.  Touch **TIME**.
2.   Enter 40 seconds by touching **4** and then **0**.
3.  Touch **POWER LEVEL**.

4.  Touch **8** to select power level 8. The display shows **8**.

5.  Touch **START**.

Remember:

- Cooking time can be set up to 99 minutes 99 seconds.
- When you cook on **HI** power, skip steps 3 and 4.







POWER LEVEL SETTING GUIDE

Power Level	Cooking Examples
1	<ul style="list-style-type: none"> • Softening cream cheese, and butter. • Keeping casseroles and main dishes warm.
2	<ul style="list-style-type: none"> • Softening chocolate and clarifying butter. • Heating breads, rolls, pancakes, tacos, tortillas and French toast. • Taking the chill out of fruit. Heating small amounts of food.
3	<ul style="list-style-type: none"> • Completing the cooking cycle of casseroles, stews and sauces. • Manual defrosting • Thawing meat, poultry and seafood.
4	<ul style="list-style-type: none"> • Cooking less tender cuts of meat in liquid or slow-cooking dishes • Completing the cooking cycle of less tender roasts.
5	<ul style="list-style-type: none"> • Cooking stews and soups after bringing to a boil. • Cooking custards and pasta. • Cooking rump roast, ham, veal and lamb.
6	<ul style="list-style-type: none"> • Cooking scrambled eggs. Baking cakes.
7	<ul style="list-style-type: none"> • Cooking cheese dishes.
8	<ul style="list-style-type: none"> • Reheating precooked or prepared food quickly. Cooking fish.
9	<ul style="list-style-type: none"> • Cooking onions, celery and green peppers quickly. • Reheating meat slices quickly.
HI	<ul style="list-style-type: none"> • Cooking poultry, vegetables and most casseroles. • Preheating a browning dish. Boiling water.

MINUTE TIMER

You can use the timer function of your oven for purposes other than cooking.

Example: To set 3 minutes for a telephone call:

1.  Touch **TIME**.
2.    Touch **3** , **0** and **0**.
3.  Touch **POWER LEVEL**.
4.  Touch **0** (power level 0).
5.  Touch **START**.

MULTISTAGE COOKING

- You can program up to 3 stages of cooking in sequence. To program 2-stage or 3-stage cooking, repeat the Time Cooking steps 1 to 4 on the previous page and touch **START**.
- Using the Minute Timer feature for the first stage, you can delay cooking start time by up to 99 minutes and 99 seconds.
- Using the Auto Defrost by Weight feature for the first stage, you can defrost first and can program up to 3 stages of cooking.

QUESTIONS AND ANSWERS

OPERATION

- Q.** What is wrong when the oven light will not glow?
- A.** There may be several reasons why the oven light will not glow.
- The light bulb has burned out.
 - **START** has not been touched.
- Q.** Why is steam coming out of the air exhaust vent?
- A.** Steam is normally produced during cooking. The microwave oven has been made to vent this steam.
- Q.** Can the microwave oven be damaged if it operates empty?
- A.** Yes. Never operate while empty or without the turntable positioned correctly on the roller rest.
- Q.** When the oven is plugged into a wall outlet for the first time, it might not work properly. What is wrong?
- A.** When the oven is plugged in for the first time or when power resumes after a power interruption, the microcomputer used in the oven control may temporarily become scrambled and fail to function as programmed. Unplug the oven from the wall outlet and then plug it back in. The microcomputer will then reset for proper functioning.
- Q.** Why do I see light reflection around the outer case?
- A.** This light is from the oven light located outside the oven cavity.
- Q.** Why is there noise coming from the turntable when the oven is turned on?
- A.** This noise occurs when the turntable roller rest and cavity bottom are dirty. Frequent cleaning of these parts should eliminate or reduce the noise.
- Q.** Instructions for aluminium foil use are confusing. When should I use foil?
- A.** It should be used to shield portions of food from becoming overcooked or overdefrosted. Use small flat pieces of foil for shielding. (Refer to page 7).

FOODS

- Q.** What is wrong when baked foods have a hard, dry, brown spot?
- A.** This is caused by overcooking. Shorten cooking or reheating time.
- Q.** Why do eggs sometimes pop?
- A.** The egg yolk may pop because of steam build-up inside the membrane. To prevent this, simply pierce the membrane with a toothpick before cooking it.
- CAUTION: Never microwave eggs in the shell since they may explode.**
- Q.** Why are scrambled eggs sometimes a little dry after cooking?
- A.** Eggs dry out if they are overcooked. You may need to vary the cooking time for one of these reasons:
- Eggs vary in size.
 - Eggs are at room temperature one time and at refrigerator temperature another time.
 - The shapes of utensils vary, which makes it necessary to vary cooking time.
 - Eggs continue cooking during standing time.
- Q.** What is wrong when three potatoes bake thoroughly and the fourth one is still not cooked?
- A.** The fourth potato may be slightly heavier than the others and should be cooked 30 to 60 seconds longer. Remember to allow one inch (2.5 cm) around each potato when baking. For more even cooking, place potatoes in a circle.
- Q.** Why do baked apples sometimes burst during cooking?
- A.** As in regular cooking methods, steam is formed in the interior of the apple, causing it to swell and expand during the cooking process.
- Q.** How are boil-overs avoided?
- A.** Use a larger utensil than usual for cooking. If you open the oven door or touch **STOP/CLEAR**, the food will stop boiling.
- Q.** Why does the dish become hot when I microwave food in it?
- A.** As the food becomes hot it will conduct the heat into the dish. Use oven mitts to remove food after cooking.

CLEANING

Wipe the oven inside and outside with a soft cloth and a mild detergent solution. Then rinse and wipe dry. This should be done on a weekly basis — more often if needed. Never use cleaning powders or rough pads. Excessive oil splatters on the inside top will be difficult to remove if left for many days. Wipe splatters with a wet paper towel, especially after cooking chicken or bacon.

REMOVABLE PARTS

The following parts may be removed as described. They should be washed in warm (not hot) water with a mild detergent and a soft cloth. Once they are clean, rinse them well and dry with a soft cloth. Never use cleaning powders, steel wool or rough pads.

- The turntable may be cleaned at the sink. Be careful not to chip or scratch the edges as this may cause the turntable to break during use.
- The turntable roller rest should be cleaned regularly.

SPECIAL CARE

For best performance and safety, the inner door panel and the oven front frame should be free of food or grease buildup. Wipe them often with a mild detergent. Then rinse and wipe dry. Never use cleaning powders or rough pads.

After cleaning the control panel, touch **STOP/CLEAR** to clear any entries that might have been entered accidentally while cleaning the panel.

BEFORE CALLING FOR SERVICE

You can often correct operating problems yourself. If your microwave oven fails to work properly, locate the operating problem in the chart below and try the solutions marked for each problem.

If the microwave oven still does not work properly, contact the nearest authorized service centre.

PROBLEMS

Oven will not start	X	X	X							
Err displays				X						
Arcing or sparking					X				X	
Incorrect time									X	
Unevenly cooked foods					X	X		X		X
Overcooked foods								X		
Undercooked foods					X	X	X	X		
Improper defrosting					X			X		X

POSSIBLE CAUSES

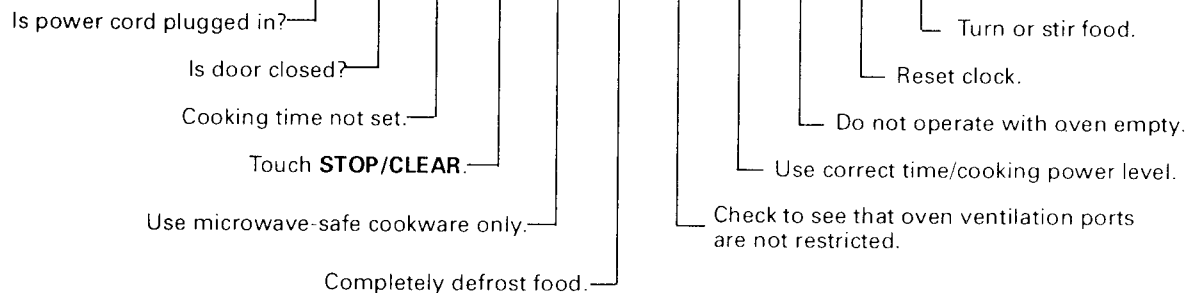

QUICK-REHEAT COOKING CHART

REHEATING Item	Amount	Time	Special Notes
Beverage			
Water-based	1 cup (250 mL)	1 - 2 min.	Heat uncovered.
	2 cups (500 mL)	3 - 4 min.	Stir after heating.
Milk-based	1 cup (250 mL)	1 - 2 min.	
	2 cups (500 mL)	3 - 4 min.	
Soups			
Broth-based	300 mL can	3 - 4 min.	Use microwave-safe casserole. Cover.
Cream-based	300 mL can	3 - 5 min.	Stir after heating.
Cooked pizza			
25 cm pizza cut into 8 portions	2 wedges	1 - 2 min.	Place on paper towels or paper plate or leave in uncovered cardboard box.
	4 wedges	2 - 3 min.	
	whole	3 - 4 min.	Arrange points toward centre.
Meat			
Sliced thin	85 -140 g	1 - 2 min.	Heat on microwave-safe plate, covered with wax paper or plastic wrap.
Sliced thick, 2.5 cm	85 -140 g	2 - 3 min.	
Chili, stews	2 cups (500 g)	3 - 5 min.	Place in microwave-safe dish. Cover. Stir halfway through cooking time.
Hamburgers, meat loaf slices, sausage patties	1 serving 2 servings 4 servings	½ - 1 min. 1 - 2 min. 2 - 4 min.	Place on microwave-safe plate. Cover with paper towel. Turn over once.
Poultry			
Chicken pieces	1 2 4 6	1 - 2 min. 2 - 3 min. 3 - 5 min. 4 - 6 min.	Heat on microwave-safe plate. Cover with wax paper or plastic wrap. If fried, cover with paper towel.
Chicken, turkey, sliced	85 -140 g	1 - 3 min.	Heat on microwave-safe plate. Cover with wax paper or plastic wrap.
Seafood			
Prawns, crab, or scallops in sauce, frozen	185 g	4 - 6 min.	Slit pouch and place on microwave-safe plate. Flex pouch to mix halfway through cooking time.
Seafood or fish casserole, frozen	450 g	5 - 7 min.	Remove from package to a microwave-safe casserole. Cover. Stir once during cooking.
Cooked rice, pasta			
	¾ cup (175 mL)	1 - 2 min.	Heat in microwave-safe casserole, covered with plastic wrap.
	1 - 2 cups (250 - 500 mL)	2 - 4 min.	
Vegetable, frozen in pouch			
	280 - 340 g	4 - 6 min.	Slit pouch. Place on microwave-safe plate. Flex pouch to mix halfway through cooking time.
Canned vegetable			
	230 g	1 - 2 min.	Use microwave-safe casserole, covered.
	425 g	2 - 4 min.	Stir once.
	500 g	3 - 5 min.	
COOKING Item	Amount	Time	Special Notes
Mashed potatoes, instant	4 servings	4 - 6 min.	Follow package directions. Reduce liquid by 1 tbsp (15 mL).
Pudding and pie filling mix	90 g	5 - 7 min.	Follow package directions. Stir once.
Porridge (Rolled oats)			
	¼ cup (50 mL)	1 - 3 min.	Add ¾ cup (175 mL) of water. Cook uncovered. Stir once. Let stand 1 minute.
	½ cup (125 mL)	3 - 5 min.	Add 1½ cup (375 mL) of water. Cook uncovered. Stir once. Let stand 1 minute.
Wheat-bran cereal			
	¼ cup (50 mL)	1 - 3 min.	Add ¾ cup (175 mL) of water. Cook uncovered. Stir once. Let stand 1 minute.
	½ cup (125 mL)	3 - 5 min.	Add 1½ cup (375 mL) of water. Cook uncovered. Stir once. Let stand 1 minute.

AUTOMATIC DEFROST CHART

- Set Auto Defrost by Weight according to instructions on page 9.
- Remove food from wrapper and place in a microwave-safe dish or place on a microwave-safe roasting rack.
- Cover thin parts with aluminium foil.
- Large roasts should be still icy in centre. Allow to stand.
- Fish and seafood should also be slightly icy.
- Food can be defrosted in a styrofoam package.
- Some types of food will need to be rearranged at the pause.

Item	Special Notes
Beef	
Ground beef	Turn over and remove defrosted portion at pause.
Liver	Drain liquid as it defrosts. Separate pieces.
Roasts	Turn over at pause. Cover ends with foil.
Sirloin steak	Turn over at pause.
Rib or T-bone	Turn over at pause.
Flank steak	Turn over at pause.
Stewing meat	Break apart at pause.
Pork	
Bacon	Defrost in original wrapper. Turn over at pause. Centre should be slightly icy.
Chops	Separate and turn over at pause.
Ribs	Turn over at pause.
Roasts	Turn over at pause. Cover ends with foil.
Lamb	
Chops	Separate and turn over at pause.
Ribs	Turn over at pause.
Roasts	Turn over at pause. Cover ends with foil.
Poultry	
Chicken, whole, up to 1.4 kg	Check for and remove any metal clamps or wires before defrosting. Turn over at pause. Cover ends with foil. Rinse under cold water.
Pieces	Separate and turn over at pause.
Cornish hens	Check for and remove any metal clamps or wires before defrosting. Turn over at pause. Rinse under cold water.
Fish and Seafood	
Crabmeat, prawns	Break apart at pause.
Fish fillets	Turn over and rearrange at pause. Rinse under cold water to separate.
Fish whole, steaks	Turn over at pause. Cover head and tail with foil.
Scallops	Break apart at pause. Remove defrosted scallops.

QUICK REFERENCE

DIRECT ACCESS COOKING

1. Touch **FROZEN VEGETABLE, POTATO or SOUP/BEVERAGE**
1 - 3 times until desired serving number appears.
2. Touch **START**.

FROZEN VEGETABLE

Once	1 serving
Twice	2 servings
3 times	3 servings

POTATO

Once	1 potato
Twice	2 potatoes
3 times	3 potatoes

SOUP/BEVERAGE

Once	1 serving
Twice	2 servings
3 times	3 servings

QUICK-REHEAT COOKING

1. Touch **QUICK REHEAT**.
2. Touch a number (0-9) for cooking time.
Touch **0** to cook 30 seconds.
Touch **1** to cook 1 minute.
Touch **2** to cook 2 minutes.
|
|
Touch **9** to cook 9 minutes.

NOTE: Quick-Reheat Cooking uses **HI** (maximum) power only.

POPCORN POPPING

1. Touch **POPCORN** 1 - 3 times until desired bag size appears.
2. Touch **START**.

Once	100 g
Twice	85 g
3 times	50 g

MINUTE TIMER

1. Touch **TIME**.
2. Touch numbers for time.
3. Touch **POWER LEVEL**.
4. Touch **0** (power level 0).
5. Touch **START**.

TIME COOKING



1. Touch **TIME**.
2. Touch numbers for cooking time (in minutes and seconds).
3. Touch **POWER LEVEL**.
4. Touch numbers (1 - 9) for power level.
5. Touch **START**.

NOTE: To set **HI POWER** cooking, skip steps 3 and 4.

AUTOMATIC DEFROST

1. Touch **AUTO DEFROST**.
2. Enter the weight of food in kg.
3. Touch **START**.
4. At pause, rearrange food.
5. Touch **START** to restart.

CLOCK

1. Touch .
2. Touch numbers to set time.
3. Touch .

For your protection in the event of theft or loss of this product, please fill in the information below :

Model No.

(Located on cavity front)

Serial No.

(Located on cavity front)

Date of Purchase

Purchased Price

Where Purchased

SANYO

SANYO Electric Co. Ltd.

6/97 Printed in Singapore

Code No. 432-6-414S-35800