



INSTRUCTION MANUAL

EM-S728/EM-S829

Microwave Oven

TABLE OF CONTENTS

Safety Instructions

■ PRECAUTIONS TO AVOID POSSIBLE EXPOSURE TO EXCESSIVE MICROWAVE ENERGY... inside cover	
■ Important Safety Instructions	1

Setting up & Getting to Know Your Oven

■ Earthing Instructions	2
■ Installation	2
■ Names of Oven Parts and Accessories	3
■ Control Panel and Features	4
■ Setting Clock	5
■ Child Lock-Out	5
■ Utensils	6

Operating Instructions

■ Quick-On Cooking	7
■ Hold Warm	7
■ Automatic Defrost by Weight	8
■ Automatic Meat Cooking by Weight	9
■ Direct Access Food Reheating/Cooking	10
■ Time Cooking	11
■ Minute Timer	12
■ Multistage Cooking	12

Care of Your Microwave Oven

■ Questions and Answers	13
■ Cleaning	14
■ Before Calling for Service	14

Chart

■ Quick-On Cooking Chart	15
■ Automatic Defrost Chart	16
■ Direct Access Food Reheating/Cooking Chart	17

Quick Reference..... back cover

Read these instructions carefully before use. If you follow the instructions, your microwave oven will provide you with many years of good service.

SAVE THESE INSTRUCTIONS

SPECIFICATIONS

Model	EM-S728	EM-S829
Power Consumption	1260W	1330W
Maximum Output	820W*	910W*
Oven Capacity	27.1 L	35.9 L
Turntable Diameter	340 mm	360 mm
Dimensions (w x h x d)	525 mm x 283 mm x 418 mm	550 mm x 311 mm x 451 mm
Weight (Approx.)	17.8 kg	20.0 kg

*According to IEC-705 test procedures.

Specifications subject to change without notice.

PROPER AND SAFE USE OF YOUR OVEN

- The oven must be level.
- The turntable and turntable roller rest must be in the oven during cooking.
- Place the cookware gently on the turntable and handle it carefully to avoid possible breakage.
- The oven has several built-in safety switches to ensure that the power remains off when the door is open. Do not tamper with these switches.
- Do not operate the microwave oven empty.
- Do not overcook food. A small quantity of food with low moisture content or high fat or sugar content can burn.
- Do not cook bacon directly on the turntable. Excessive local heating of the turntable may cause it to break.
- Avoid heating baby bottles or baby food jars. Transfer the food into a suitable container for the microwave oven. The food temperature should be tested before giving it to the baby.
- Do not heat narrow-necked containers, such as syrup bottles.
- Do not attempt to deep-fry in your microwave oven as the temperature of oil cannot be controlled.
- Do not heat cans. Transfer the contents into a microwave-safe dish before heating.
- Do not use this microwave oven for commercial purposes. This microwave oven is made for household use only.

NOTE

- It is quite normal for steam to be emitted around the door, for misting to occur on the door, or even for water droplets to appear below the door during the cooking cycle. This is merely condensation from the heat of the food.

PRECAUTIONS TO AVOID POSSIBLE EXPOSURE TO EXCESSIVE MICROWAVE ENERGY

- (a) Never interfere or tamper with safety interlocks.
- (b) Do not place any object between the oven front face and the door or allow soil or cleaner residue to accumulate on door sealing surfaces. Wipe the door sealing area frequently with a mild detergent, rinse and wipe dry. Never use abrasive powders or pads.
- (c) When open, the door must not be subjected to strain; for example, a child hanging on the opened door or any load on it could cause the oven to fall forward, and the weight could also damage the door.
- (d) Do not operate the oven if it is damaged. It is particularly important that the oven door closes properly and that there is no damage to the:
 - (1) DOOR (bent)
 - (2) HINGES AND LATCHES (broken or loosened)
 - (3) DOOR SEALS AND SEALING SURFACES

IMPORTANT SAFETY INSTRUCTIONS

When using electrical appliances, basic safety precautions should be followed, including the following:

WARNING – To reduce the risk of burns, electric shock, fire, injury to persons or exposure to excessive microwave energy:

1. Read all instructions before using.
2. As with most cooking appliances, close supervision is necessary to reduce the risk of a fire in the oven cavity.

If a fire should start:

- Keep the oven door closed
- Turn the oven off, and
- Disconnect the power cord or shut off power at the fuse or circuit breaker panel.

Keep in mind the following rules at all times:

- a. Do not overcook food. Overcooked food can cause fires in the oven. Carefully attend to the oven's activities, especially if paper, plastic, or other combustibles are inside.
- b. Do not store combustible items such as bread, cookies, paper products, etc. inside the oven. They may catch fire if turned on accidentally.
- c. Do not use wire twist-ties in the oven. Be sure to inspect purchased items for wire twist-ties and remove before placing food in the oven.

3. Some products such as eggs in the shell, water with oil or fat, sealed containers and closed glass jars may explode and therefore should not be heated in this oven.
4. Use this oven only for its intended uses as described in the manual. It is not designed for industrial or laboratory use. Never use corrosive chemicals or vapors in this oven.
5. As with any appliance, children should use the oven only under adult supervision.
6. Do not store or use this appliance outdoors.
7. Keep the oven away from heat and water sources. Exposure to heat and water can lower efficiency and lead to malfunctioning.
8. When heating water or other liquids, use a wide necked container to allow air bubbles to escape freely. Using narrow-necked containers may cause the liquid to boil over. This may happen even after the cooking has stopped.
9. It is important to keep the door and the oven interior clean.
(See "Cleaning" instructions on page 14.)

WARNING

- (a) Do not adjust or repair microwave oven yourself. Do not operate the oven if it is damaged, until it has been repaired by a service engineer trained by the manufacturer.
- (b) It is dangerous for anyone other than a properly qualified engineer trained by the manufacturer to carry out adjustments or repairs.
- (c) If the power supply cord is damaged, it must be replaced by the manufacturer, as a specially prepared cord is required.
- (d) On no account remove or interfere with any parts or screws.
THIS COULD PROVE VERY DANGEROUS.

SAVE THESE INSTRUCTIONS

EARTHING INSTRUCTIONS

This appliance must be earthed. If there is an electrical short circuit, earthing reduces the risk of electric shock by providing an escape wire for the electric current. This appliance is equipped with a cord that has a earthing wire with a earthing plug. The plug must be plugged into an outlet that is properly installed and earthed.

The electrical power cord must be kept dry and must not be pinched or crushed in any way.

WARNING - Improper use of the earthing plug can result in electric shock.

INSTALLATION

Remove all packing material and accessories. Examine the oven for any damage such as dents or a broken door. Do not install if oven is damaged.

1. Select a level surface that provides enough open space (see illustration at right) for the inlet and/or outlet vents.
 - Leave a minimum clearance of 7.5 cm above the oven.
 - Do not remove the legs from the bottom of the oven.
 - Blocking the inlet and/or outlet openings can damage the oven.
 - Do not install oven over a range, cooktop or other heat-producing appliance.
 - Place the oven as far away from radios and T.V.'s as possible.
 - Cabinet is covered with a protective film which should be removed to fully show the intended colour and finish.
2. Plug your oven into a standard household outlet. Be sure that your microwave oven is the only appliance on the circuit.

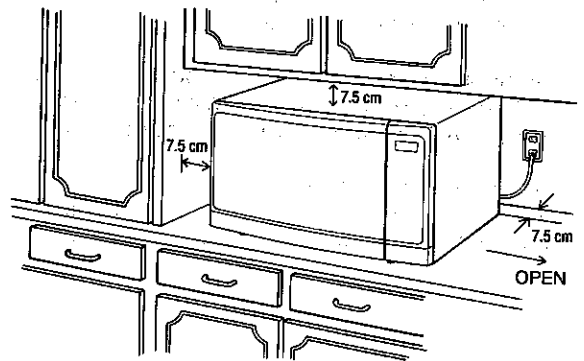

A minimum clearance of 7.5 cm is required between the oven and any adjacent wall. One side must be open.

NAMES OF OVEN PARTS AND ACCESSORIES

Remove the oven and all materials from the carton.
Your oven comes with the following accessories:

Turntable	1
Turntable roller rest	1
Instruction Manual	1

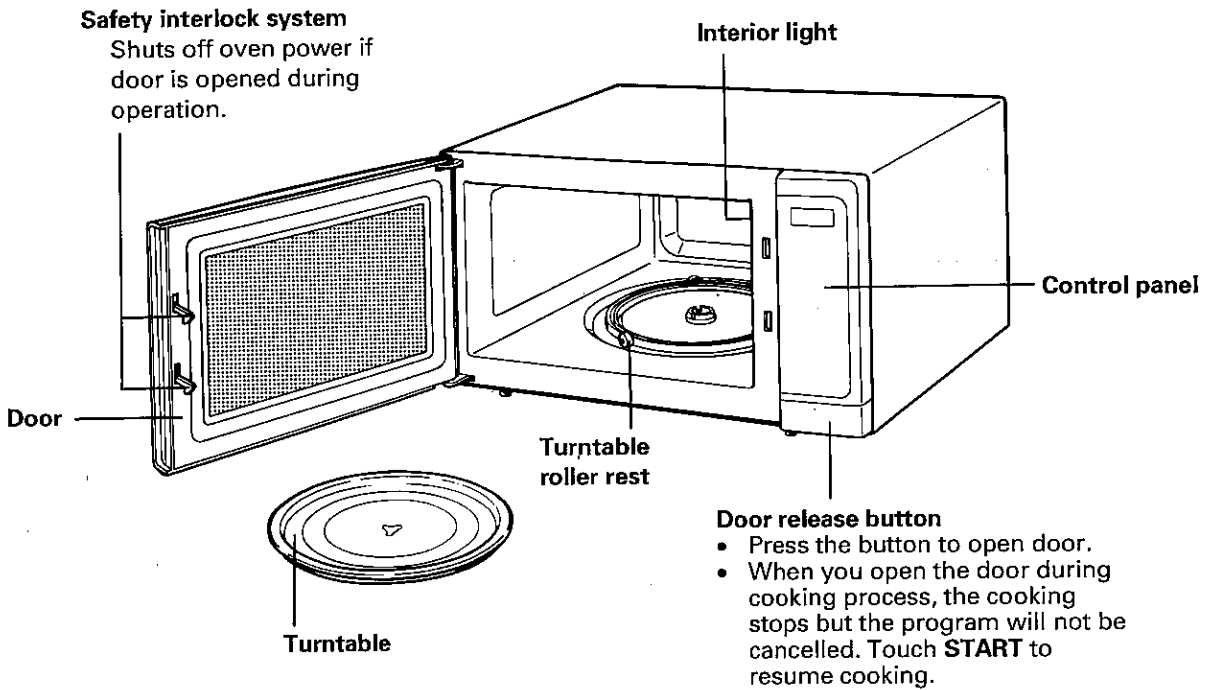

TURNTABLE INSTALLATION

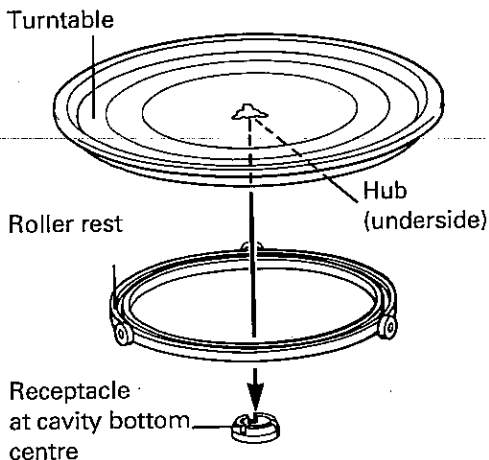

1. Place the roller rest on the cavity bottom.
 2. Place the turntable on top of the roller rest as shown in the diagram. Make sure the turntable hub is securely locked in the receptacle. **Never place the turntable upside down.** The turntable rotation should never be restricted.
- Both turntable and roller rest must always be used during cooking.
 - All food and containers of food are always placed on this turntable for cooking.
 - **This turntable returns to its original starting position** when cooking is finished. The light and fan will remain on but microwave power is turned off.
 - This turntable rotates clockwise and counterclockwise; this is normal.

CONTROL PANEL AND FEATURES

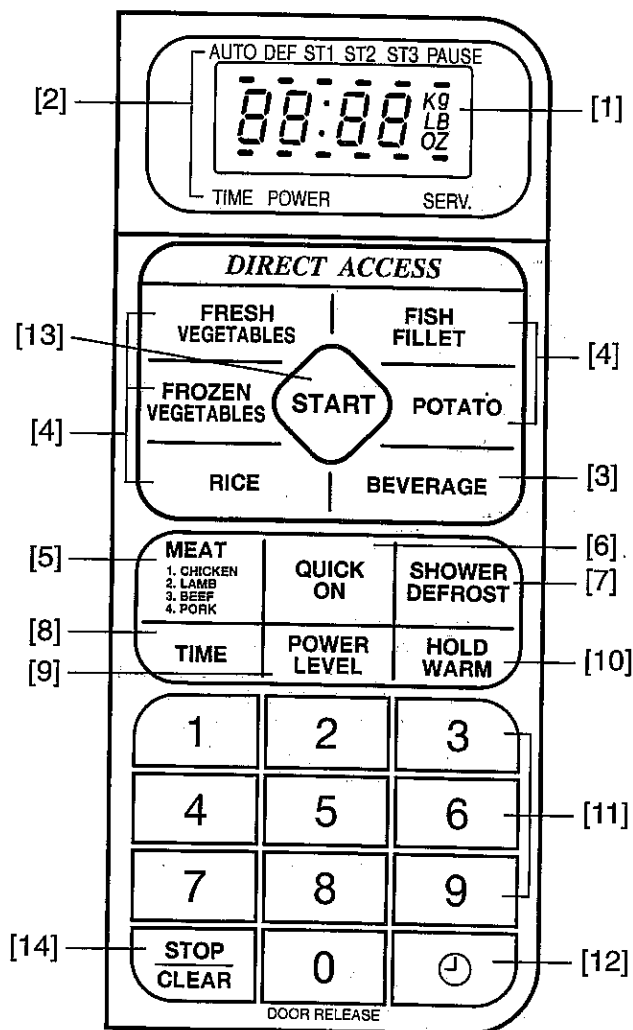

[1] Display Window

Counts down cooking time in seconds.
Shows clock time when oven is not in use.

[2] Indicators

ST1/ ST2/ ST3 : Cooking stage indicators
AUTO/ DEF/ PAUSE : Cooking mode indicators

TIME/ POWER/ SERV./ Kg/ g : A flashing indicator prompts you to enter desired cooking time, power setting, food weight or number of servings.

DIRECT ACCESS menu keypads

[3] Reheating keypads (page 10)

[4] Cooking menu keypads (page 10)

Auto menu keypads

[5] **MEAT** (page 9)

1. CHICKEN

2. LAMB

3. BEEF

4. PORK

[6] **QUICK ON** (page 7)

[7] **SHOWER DEFROST** (page 8)

[8] **TIME** keypad (page 11)

[9] **POWER LEVEL** keypad (page 11)

[10] **HOLD WARM** keypad (page 7)

[11] Number keypad

[12] **Clock** keypad (page 5)

[13] **START** keypad

[14] **STOP/CLEAR** keypad

Clears all previous setting if pressed before cooking starts. During cooking: touch once to stop oven; twice to stop and clear all entries.







Beep Sound

A beep tone sounds when a keypad on the control panel is touched to indicate a setting has been entered.

SETTING CLOCK

When your oven is plugged in for the first time or when power resumes after a power interruption, the numbers in the display reset to **0:00**. Set the clock.

Example: To set 3:15 :

1.  Touch .
2.    Touch number keypads **3**, **1** and **5**.
3.  Touch .
The clock starts counting.

Remember:

- If the clock (or display) shows any abnormality, unplug the oven from the AC outlet. Plug it in again and then reset the clock.

CHILD LOCK-OUT

Your oven has a safety feature which prevents children from accidentally turning it on. Even if the oven is accidentally programmed to cook, no cooking takes place when this feature is set.

To set :

1. Touch .
2. Touch **9** four times.
3. Touch **START**.

Indicator **L** lights and clock display reappears.

To cancel :

1. Touch .
2. Touch **7** four times.
3. Touch **START**.

Indicator **L** disappears and clock display reappears.

UTENSILS

MATERIALS YOU CAN USE IN MICROWAVE OVEN

Utensils	Use	Remarks
Aluminium foil	Shielding	Small smooth pieces can be used to cover thin parts of meat or poultry to prevent overcooking. Arcing can occur if foil is too close to oven walls. The foil should be at least 2.5 cm away from oven walls. Do not cover food completely with aluminium foil.
Browning dish	Searing meats	Follow manufacturer's instructions. The bottom of browning dish must be at least 5 mm above the turntable. Incorrect usage may cause the turntable to break.
Dinnerware	Reheating and short-term cooking	Microwave-safe only. Follow manufacturer's instructions. Do not use cracked or chipped dishes.
Glass jars	Warming	Always remove lid. Use only to heat food until just warm. Most glass jars are not heat resistant and may break.
Glassware	Cooking	Heat-resistant oven glassware only. Make sure there is no metallic trim. Do not use cracked or chipped dishes.
Oven cooking bags	Cooking	Follow manufacturer's instructions. Do not close with metal tie. Make slits to allow steam to escape.
Paper plates and cups	Short-term warming and cooking	Use for short-term cooking/warming only. Do not leave oven unattended while cooking.
Paper towels	Reheating and short-term cooking	Use to cover food for reheating and absorbing fat. Use with supervision for a short-term cooking only.
Parchment paper	Cooking	Use as a cover to prevent spattering or a wrap for steaming.
Plastic	Reheating and short-term cooking	Microwave-safe only. Follow the manufacturer's instructions. Should be labeled "Microwave Safe." Some plastic containers soften as the food inside gets hot.
Plastic wrap	Cooking	Microwave-safe only. Use to cover food during cooking to retain moisture.
Thermometers	Cooking	Microwave-safe only (meat and candy thermometers).
Wax paper	Cooking	Use as a cover to prevent spattering and to retain moisture.

MATERIALS TO BE AVOIDED IN MICROWAVE OVEN

Utensils	Remarks
Aluminium tray	Aluminium tray may cause arcing. Transfer the food packaged in an aluminium tray into a microwave-safe dish before cooking.
Food carton with metal handle	May cause arcing. Transfer food into microwave-safe dish.
Metal or metal-trimmed utensils	Metal shields the food from microwave energy. Metal trim may cause arcing.
Metal twist ties	They may cause arcing and could cause a fire in the oven.
Paper bags	May cause a fire in the oven.
Plastic foam cups	Plastic foam may melt or contaminate the liquid inside when exposed to high temperature.
Wood	Wood will dry out when used in the microwave oven and may split or crack.

UTENSIL TEST: Fill a microwave-safe container with 1 cup of cold water (250 mL) and place it in the oven along with the utensil in question. Cook on **HI** power for 1 minute. Carefully feel the utensil. If the empty utensil is warm, it should not be used for microwave cooking. **Do not exceed 1 minute testing time.** This test cannot be used for plastic containers.

CAUTION:



Make sure that closed containers are opened and plastic pouches pierced before cooking. Tightly-closed utensils could explode.

QUICK-ON COOKING (HI-POWER)

A time-saving feature, this simplified control lets you quickly set and start microwave cooking without the need to touch **START**.

You can choose from nine preset cooking time selections (1 to 9 minutes) to cook at highest power level. Quick-On cooking chart appears on page 15.

Example: To set Quick-On cooking for 2 minutes:

1.  Touch **QUICK ON**.
2.  Touch **2**.
The oven begins cooking and display shows time counting down.



Remember:

- You may open the door to stop cooking before the selected time is over. To start again, close the door and touch **START**.

HOLD WARM

Hold Warm keeps food warm up to 100 minutes after a cooking program is completed or until the door is opened or **STOP/CLEAR** is pressed. **HOLD** appears in the display.

You can also use Hold Warm alone without setting a cooking program, or with any of the featured cooking programs.

1.  Touch **HOLD WARM**.
2. Set the desired cooking program.
3.  Touch **START**.
After cooking program, **HOLD** appears in the display.

AUTOMATIC DEFROST BY WEIGHT

The Auto Defrost by Weight feature allows precise, even defrosting of frozen foods — automatically. Just touch the **SHOWER DEFROST** key, then enter the frozen food's weight using the number keys (weight up to 2.9 kg). The oven selects 1 kg if a weight is not entered.







Pause

This feature has a built-in pause mechanism to allow for checking and rearranging the food. The oven stops at the end of the first defrost period (about ¼ of the total defrost time). If you do not open the door at the pause, the oven restarts after 5 minutes and commences the second defrost period.

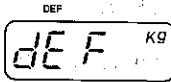
Auto Defrosting chart appears on page 16.

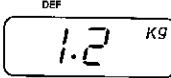
For manual defrosting using Time Cooking, see page 11.

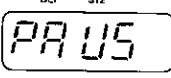
Example: To defrost 1.2 kg of chicken pieces:

1.  Touch **SHOWER DEFROST**.

2.   Enter the weight by touching 1 and then 2.

3.  Touch **START**.

4. The oven stops automatically at pause. Separate, rearrange or turn food over.
5.  Touch **START**.

Remember:

- The oven automatically selects 1 kg if the weight is not entered.
- To enter a weight of less than 1 kg, always press **0** first. For example, to enter 0.2 kg, press **0** and then **2**.
- Only one digit can be entered after a decimal point. If in doubt, convert to the lower number.

Defrosting Tips:

- Check the food during defrosting.
- Remove frozen food from its original paper or plastic wrap/package. When it is difficult to remove the wrap, defrost the food in the wrap until **PAUS** appears. At the pause, remove the wrap.
- Place foods in a flat microwave-safe baking dish or roasting rack to catch drippings.
- Food should still be somewhat icy in the centre when removed from the oven.
- The Auto Defrost menu includes standing time.

CONVERSION TABLE

lbs - oz	grams	kg	lbs - oz	grams	kg
4 oz	100	0.1	3 lb-9 oz	1600	1.6
7 oz	200	0.2	3 lb-12 oz	1700	1.7
10 oz	300	0.3	4 lb	1800	1.8
14 oz	400	0.4	4 lb-3 oz	1900	1.9
1 lb-2 oz	500	0.5	4 lb-7 oz	2000	2.0
1 lb-5 oz	600	0.6	4 lb-10 oz	2100	2.1
1 lb-9 oz	700	0.7	4 lb-14 oz	2200	2.2
1 lb-12 oz	800	0.8	5 lb-1 oz	2300	2.3
2 lb	900	0.9	5 lb-5 oz	2400	2.4
2 lb-4 oz	1000	1.0	5 lb-8 oz	2500	2.5
2 lb-7 oz	1100	1.1	5 lb-12 oz	2600	2.6
2 lb-11 oz	1200	1.2	5 lb-15 oz	2700	2.7
2 lb-14 oz	1300	1.3	6 lb-3 oz	2800	2.8
3 lb-2 oz	1400	1.4	6 lb-6 oz	2900	2.9
3 lb-5 oz	1500	1.5			

AUTOMATIC MEAT COOKING BY WEIGHT

This feature is accurate cooking method for meat from **0.5 kg** up to **2.5 kg**.

The oven automatically selects 1 kg. If food weight is more or less than 1 kg, enter the weight using the number keypads.

This feature has a built-in pause mechanism to allow for checking, turning or rearranging the food.

Meat Cooking Tips:

- Doneness varies with meat of different shape and weight.
- Meat should be completely thawed before cooking.
- Place meat on a microwave-safe roasting rack or rack in a dish.
- All meat may be seasoned as desired before cooking.
- Use wax paper or plastic wrap to stop splattering.
- Aluminium foil can be used to cover thin parts of meat or chicken wings and legs to prevent overcooking. Foil should be applied at pause.
- While chicken or meat is standing, cover with foil to keep in the heat.

Example: To cook 1.2 kg of Lamb:

1.



twice

Touch **MEAT** twice.

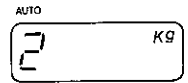

Enter the food course number by touching MEAT keypad:

Touch MEAT keypads	COURSE Number
once	1 (CHICKEN)
twice	2 (LAMB)
3 times	3 (BEEF)
4 times	4 (PORK)

2.



Enter the food weight by touching 1 and then 2.

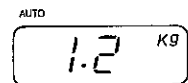

3.



Touch **START**.

4.

The oven stops automatically at pause. Separate, rearrange or turn food over.

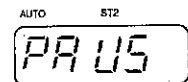

5.



Touch **START**.

Remember:

- The oven automatically selects 1 kg, if the weight is not entered.
- To enter a weight of less than 1 kg, always press 0 first. For example, to enter 0.5 kg, press 0 and then 5.
- Only one digit can be entered after a decimal point. If in doubt, use the lower number.
- If you do not open the door at the pause, the oven restarts after 5 minutes.

Item	Directions
1. CHICKEN	Whole: Remove the giblets, rinse in cold water and pat dry. Tie legs together with string. Place breast side down on a roasting rack. Turn over at pause. Let stand 10 - 20 minutes. Pieces: Arrange pieces skin side down. Turn and rearrange at pause. Let stand 5 - 10 minutes.
2. LAMB	Tie meat with string. Place meat fat side down on a roasting rack.
3. BEEF	Turn over at pause.
4. PORK	Let stand 10 - 20 minutes.

DIRECT ACCESS FOOD REHEATING/COOKING

FRESH VEGETABLES, FROZEN VEGETABLES, RICE, FISH FILLET, POTATO, BEVERAGE feature keypads are present on your oven control panel.

These keypads allow you to cook one to three servings of food automatically. Simply touch the appropriate keypads, once for each serving and then touch **START**.

Follow the directions included in the chart.

Direct Access food chart appears on page 17.

Cooking Tips:

FRESH VEGETABLES:

- Weight is given before peeling, trimming, slicing, etc.

FROZEN VEGETABLES:

- Follow package directions for venting cover, adding water, piercing pouch, replacing foil, covering with plastic wrap, etc.
- Stir during cooking time.

FISH FILLET:

- Fish should be completely thawed before cooking.
- Arrange in a single layer in dish.

POTATO:

- Arrange in a circular pattern with heavier ends pointing toward the outer edge of the dish.
- Turn over during cooking time.

BEVERAGE:

- Foods must be at room or refrigeration temperature.

Example: To cook 2 servings of potato:

1.



twice

Touch **POTATO** twice..

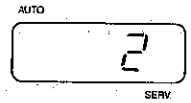

Enter the number of servings by touching a desired menu keypad:

Touch menu keypad	To cook
once	1 serving
twice	2 servings
3 times	3 servings

2.



Touch **START**.

Cooking starts. The time counts down in the display.

Item	1 serving	Directions
FRESH VEGETABLES	150 g	Place in a bowl or dish. Add 1 tbsp. water. Cover.
FROZEN VEGETABLES	150 g	Place in a bowl or dish. Cover.
RICE (long grain)	½ cup (125 mL)	Cook with water and salt in a deep dish. Cover. See page 17.
FISH FILLET	170 g	Use a shallow dish. Cover with plastic wrap.
POTATO	170 g	Pierce with fork. Place on paper towel. Let stand 3 - 5 minutes.
BEVERAGE	1 cup (230 mL)	Stir after reheating.

NOTE: Use microwave-safe dish, bowl or cup.

TIME COOKING

This basic microwave cooking method allows you to cook food for a desired time. In addition to the **HI** (maximum) power level, you can select different microwave power from 9 levels, **1** (10% of total power) to **9** (90% power) for the foods that require slower cooking. The oven also provides power level **0** (no power) so that the clock can be utilized as a minute timer. See page 12 for details.







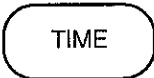

Foods with high moisture content should be cooked on maximum power, as this is the fastest cooking method and best maintains the natural flavour and texture of the foods.

To check the power level during cooking, touch **POWER LEVEL**. The power level appears in the display window.

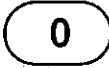
Manual Defrosting

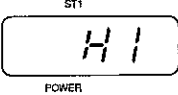
For manual defrosting (without using Auto Defrost features), use power level 3. To speed up the defrosting of dense foods over 450 g, you may start on **HI** for **3 minutes**, then reduce to the level 3.

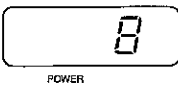
Example: To cook at power level 8 for 40 seconds:

1.  Touch **TIME**.
2.   Enter 40 seconds by touching **4** and then **0**.
3.  Touch **POWER LEVEL**.  ST1
POWER
4.  Touch **8** to select power level 8. The display shows **8**.  ST1
POWER
5.  Touch **START**.

Remember:

- Cooking time can be set up to 99 minutes 99 seconds.
- When you cook on **HI** power, skip steps 3 and 4.







MULTIPOWER SETTING GUIDE

Power Level	Cooking Examples
1	<ul style="list-style-type: none"> • Softening cream cheese. • Keeping casseroles and main dishes warm.
2	<ul style="list-style-type: none"> • Softening chocolate and clarifying butter. • Heating breads, rolls, pancakes, tacos, tortillas and French toast. • Taking the chill out of fruit. Heating small amounts of food.
3	<ul style="list-style-type: none"> • Completing the cooking cycle of casseroles, stews and sauces. • Manual Defrosting. • Thawing meat, poultry and seafood.
4	<ul style="list-style-type: none"> • Cooking less tender cuts of meat in liquid or slow-cooking dishes. • Completing the cooking cycle of less tender roasts.
5	<ul style="list-style-type: none"> • Cooking stews and soups after bringing to a boil. • Cooking custards and pasta. • Cooking rump roast, ham, veal and lamb.
6	<ul style="list-style-type: none"> • Cooking scrambled eggs. Baking cakes.
7	<ul style="list-style-type: none"> • Cooking cheese dishes, eggs and milk.
8	<ul style="list-style-type: none"> • Reheating precooked or prepared food quickly.
9	<ul style="list-style-type: none"> • Cooking onions, celery and green peppers quickly. • Reheating meat slices quickly.
HI	<ul style="list-style-type: none"> • Cooking poultry, fish, vegetables and most casseroles. • Preheating a browning dish. Boiling water.

MINUTE TIMER

You can use the timer function of your oven for purposes other than cooking.

Example: To set 3 minutes for a telephone call:

1.  Touch **TIME**.
2.    Touch **3**, **0** and **0**.
3.  Touch **POWER LEVEL**.
4.  Touch **0** (power level 0).
5.  Touch **START**.

MULTISTAGE COOKING

You can program up to 3 stages of cooking in sequence. Auto Defrost by Weight can be programmed before the first stage to defrost first and then cook.

- To program 2-stage or 3-stage cooking, repeat the Time Cooking steps 1 to 4 on the previous page and touch **START**.
- Using the Minute Timer feature for the first stage, you can delay cooking start time by up to 99 minutes and 99 seconds.

QUESTIONS AND ANSWERS

OPERATION

- Q.** What is wrong when the oven light does not glow?
- A.** There may be several reasons why the oven light does not glow. Perhaps:
- Door is not closed and locked. Push firmly to be sure that door is locked properly.
 - The light bulb has burned out.
- Q.** Why is steam coming out of the air exhaust vent?
- A.** Steam is normally produced during cooking. The microwave oven has been made to vent this steam.
- Q.** Can the microwave oven be damaged if it operates empty?
- A.** Yes. Never operate while empty or without the turntable positioned correctly on the roller rest.
- Q.** When the oven is plugged into a wall outlet for the first time, it might not work properly. What is wrong?
- A.** When the oven is plugged in for the first time or when power resumes after a power interruption, the microcomputer used in the oven control may temporarily become scrambled and fail to function as programmed. Unplug the oven from the wall outlet and then plug it back in. The microcomputer will then reset for proper functioning.
- Q.** Why do I see light reflection around the outer case?
- A.** This light is from the oven light located outside the oven cavity.
- Q.** Why is there noise coming from the turntable when the oven is turned on?
- A.** This noise occurs when the turntable roller rest and cavity bottom are dirty. Frequent cleaning of these parts should eliminate or reduce the noise.
- Q.** Instructions for aluminium foil use are confusing. When should I use foil?
- A.** It should be used to shield portions of food from becoming overcooked or overdefrosted. Use small flat pieces of foil for shielding.

FOODS

- Q.** What is wrong when baked foods have a hard, dry brown spot?
- A.** This is caused by overcooking. Shorten cooking or reheating time.
- Q.** Why do eggs sometimes pop?
- A.** The egg yolk may pop because of steam build-up inside the membrane. To prevent this, simply pierce the membrane with a toothpick before cooking it.
- CAUTION: Never microwave eggs in the shell since they may explode.**
- Q.** Why are scrambled eggs sometimes a little dry after cooking?
- A.** Eggs dry out if they are overcooked. You may need to vary the cooking time for one of these reasons:
- Eggs vary in size.
 - Eggs are at room temperature one time and at refrigerator temperature another time.
 - The shapes of utensils vary, which makes it necessary to vary cooking time.
 - Eggs continue cooking during standing time.
- Q.** What is wrong when three potatoes bake thoroughly and the fourth one is still not cooked?
- A.** The fourth potato may be slightly heavier than the others and should be cooked 30 to 60 seconds longer. Remember to allow 2.5 cm around each potato when baking. For more even cooking, place potatoes in a circle.
- Q.** Why do baked apples sometimes burst during cooking?
- A.** The peel has not been removed from the top half of each apple to allow for expansion of the interior of the apple during cooking. As in regular cooking methods, the interior of the apple expands during the cooking process.
- Q.** How are boil-overs avoided?
- A.** Use a larger utensil than usual for cooking. If you open the oven door or touch **STOP/CLEAR**, the food will stop boiling.
- Q.** Why does the dish become hot when I microwave food in it?
- A.** As the food becomes hot it will conduct the heat into the dish. Use oven mitts to remove food after cooking.

CLEANING

Wipe the oven inside and outside with a soft cloth and a mild detergent solution. Then rinse and wipe dry. This should be done on a weekly basis - more often if needed. Never use cleaning powders or rough pads. Excessive oil splatters on the inside top will be difficult to remove if left for many days. Wipe splatters with a wet paper towel, especially after cooking chicken or bacon.

REMOVABLE PARTS

The following parts may be removed as described. They should be washed in warm (not hot) water with a mild detergent and a soft cloth. Once they are clean, rinse them well and dry with a soft cloth. Never use cleaning powders, steel wool or rough pads.

- The turntable may be removed at the sink. Be careful not to chip or scratch the edges as this may cause the turntable to break during use.
- The turntable roller rest should be cleaned regularly.

SPECIAL CARE

For best performance and safety, the inner door panel and the oven front frame should be free of food or grease buildup. Wipe them often with a mild detergent. Then rinse and wipe dry. Never use cleaning powders or rough pads.

After cleaning the control panel, touch **STOP/CLEAR** to clear any entries that might have been entered accidentally while cleaning the panel.

BEFORE CALLING FOR SERVICE

You can often correct operating problems yourself. If your microwave oven fails to work properly, locate the operating problem in the chart below and try the solutions marked for each problem.

If the microwave oven still does not work properly, contact the nearest authorized service centre.

PROBLEMS

Oven will not start	X	X	X										
Err displays				X									
Arcing or sparking					X					X			
Incorrect time											X		
Unevenly cooked foods					X	X		X					X
Overcooked foods								X					
Undercooked foods					X	X	X	X					
Improper defrosting					X			X					X

POSSIBLE CAUSES

Is power cord plugged in?

Is door closed?

Cooking time not set.

Touch **STOP/CLEAR**.

Use microwave-safe cookware only.

Completely defrost food.

Turn or stir food.

Reset clock.

Do not operate with oven empty.

Use correct time/cooking power level.

Check to see that oven ventilation ports are not restricted.

QUICK-ON COOKING CHART

Item	Amount	Time	Special Notes
Beverage			
Water-based	1 cup (250 mL)	1 - 2 min.	Heat uncovered.
	2 cups (500 mL)	2 - 4 min.	Stir after heating.
Milk-based	1 cup (250 mL)	1 - 2 min.	
	2 cups (500 mL)	2 - 4 min.	
Soups			
Broth-based	300 mL can	2 - 3 min.	Use microwave-safe casserole. Cover.
Cream-based	300 mL can	3 - 4 min.	Stir after heating.
Cooked pizza			
25 cm cut in 8 portions	2 wedges	1 - 2 min.	Place on paper towels or paper plate or leave in uncovered cardboard box. Arrange points toward centre.
	4 wedges	2 - 3 min.	
	whole	3 - 4 min.	
Meat			
Sliced thin	85 -140 g	1 min.	Heat on microwave-safe plate, covered with wax paper or plastic wrap.
Sliced thick, 2.5 cm	85 -140 g	1 - 2 min.	
Chili, stews	2 cups (500 g)	3 - 4 min.	Place in microwave-safe dish. Cover. Stir halfway through cooking time.
Hamburgers, meat loaf slices, sausage patties	1 serving	1 min.	Place on microwave-safe plate. Cover with paper towel. Turn over once.
	2 servings	1 - 2 min.	
	4 servings	2 - 3 min.	
Poultry			
Chicken pieces	1	1 min.	Heat on microwave-safe plate. Cover with wax paper or plastic wrap. If fried, cover with paper towel.
	2	1 - 2 min.	
	4	2 - 3 min.	
	6	3 - 5 min.	
Chicken, turkey, sliced	85 -140 g	1 - 2 min.	Heat on microwave-safe plate. Cover with wax paper or plastic wrap.
Seafood			
Prawns, crab, or scallops in sauce, frozen	185 g	3 - 5 min.	Slit pouch and place on microwave-safe plate. Flex pouch to mix halfway through cooking time.
Seafood or fish casserole, frozen	450 g	4 - 6 min.	Remove from package to a microwave-safe casserole. Cover. Stir once during cooking.
Cooked rice, pasta			
	1 cup (250 mL)	1 - 2 min.	Heat in microwave-safe casserole, covered with plastic wrap.
	2 cups (500 mL)	2 - 3 min.	
Vegetable, frozen in pouch	280 - 340 g	3 - 5 min.	Slit pouch. Place on microwave-safe plate. Flex pouch to mix halfway through cooking time.
Mashed potatoes, instant	4 servings	3 - 5 min.	Follow package directions. Reduce liquid by 1 tbsp (15 mL).
Canned vegetable			
	230 g	1 - 2 min.	Use microwave-safe casserole, covered. Stir once.
	425 g	2 - 3 min.	
	500 g	2 - 4 min.	
Pudding and pie filling mix	90 g	4 - 6 min.	Follow package directions. Stir once.
Porridge			
(Rolled oats)	¼ cup (50 mL)	1 - 2 min.	Add ¾ cup (175 mL) of water. Cook uncovered. Stir once. Let stand 1 minute. Add 1½ cup (375 mL) of water. Cook uncovered. Stir once. Let stand 1 minute.
	½ cup (125 mL)	3 - 4 min.	
Wheat-bran cereal	¼ cup (50 mL)	1 - 2 min.	Add ¾ cup (175 mL) of water. Cook uncovered. Stir once. Let stand 1 minute. Add 1½ cup (375 mL) of water. Cook uncovered. Stir once. Let stand 1 minute.
	½ cup (125 mL)	3 - 4 min.	

AUTOMATIC DEFROST CHART

- Set Auto Defrost by Weight according to instructions on page 8.
- Remove food from wrapper and place in a microwave-safe dish.
- Cover thin parts with aluminium foil.
- Use a microwave-safe roasting rack to hold small items, such as chicken pieces, fish, prawns and scallops.
- Large roasts should be still icy in centre. Allow to stand.
- Fish and seafood should also be slightly icy. Allow to stand.

Item	Special Notes
Beef	
Ground beef	Turn over and remove defrosted portion at pause.
Liver	Drain liquid as it defrosts. Separate pieces.
Roasts	Turn over at pause. Cover ends with foil.
Sirloin steak	Turn over at pause.
Rib or T-bone	Turn over at pause.
Flank steak	Turn over at pause.
Stewing meat	Break apart at pause.
Pork	
Bacon	Defrost in original wrapper. Turn over at pause. Centre should be slightly icy.
Chops	Separate and turn over at pause.
Ribs	Turn over at pause.
Roasts	Turn over at pause. Cover ends with foil.
Lamb	
Chops	Separate and turn over at pause.
Ribs	Turn over at pause.
Roasts	Turn over at pause. Cover ends with foil.
Poultry	
Chicken, whole, up to 1.4 kg	Turn over at pause. Cover ends with foil. Rinse under cold water.
Pieces	Separate and turn over at pause.
Cornish hens	Turn over at pause. Rinse under cold water.
Fish and Seafood	
Crabmeat, prawns	Break apart at pause.
Fish fillets	Turn over and rearrange at pause. Rinse under cold water to separate.
Fish whole, steaks	Turn over at pause. Cover head and tail with foil.
Scallops	Break apart at pause. Remove defrosted scallops.

DIRECT ACCESS FOOD REHEATING/COOKING CHART

- Set Direct Access Food Reheating/Cooking according to instructions on page 10.
- Doneness varies with food of different shape, weight and initial temperature.

Item	Special Notes
FRESH VEGETABLES	Place in a suitable sized microwave-safe dish. Add 1 tbsp. water per serving. Cover. Let stand 2 - 3 minutes.
FROZEN VEGETABLES	Place in a suitable sized microwave-safe dish. Cover. Stir during cooking. Let stand 2 - 3 minutes.
FISH FILLET	Use microwave-safe shallow dish or pie plate. Cover lightly with plastic wrap.
POTATO	Wash and scrub well. Pierce with fork. Place on paper towel. Turn over during cooking. Let stand 3 - 5 minutes. Do not place in centre of turntable.
BEVERAGE Coffee/Tea/Hot chocolate Soup	No cover. Stir after reheating. Cover. Stir after reheating.

Cooking Guide - Rice (Long grain)

Serving	Rice	Water	Salt	Container	Standing time
1	½ cup (125 mL)	1 cup (250 mL)	¼ tsp.	1½ litre casserole	5 minutes
2	1 cup (250 mL)	2 cups (500 mL)	½ tsp.	2 litre casserole	
3	1½ cups (375 mL)	2½ cups (625 mL)	¾ tsp.	2½ litre casserole	

QUICK REFERENCE

REHEATING/COOKING BY DIRECT ACCESS

1. Touch **FRESH VEGETABLES, FROZEN VEGETABLES, RICE, FISH FILLET, POTATO or BEVERAGE** until desired serving number appears.
2. Touch **START**.

AUTOMATIC MEAT COOKING

1. Touch **MEAT 1 - 4** times to select desired course.

1 touch	CHICKEN
2 touches	LAMB
3 touches	BEEF
4 touches	PORK
2. Enter the weight of food in kg.
3. Touch **START**.
4. At pause, rearrange food.
5. Touch **START** to restart.

CLOCK

1. Touch \ominus .
2. Touch numbers to set time.
3. Touch \oplus .

QUICK-ON COOKING

(HI-power only)

1. Touch **QUICK ON**.
2. Touch a number (1-9) for cooking time (in minutes).

MINUTE TIMER

1. Touch **TIME**.
2. Touch numbers for time.
3. Touch **POWER LEVEL**.
4. Touch **0** (power level 0).
5. Touch **START**.

TIME COOKING

1. Touch **TIME**.
2. Touch numbers for cooking time. (in minutes and seconds).
3. Touch **POWER LEVEL**.
4. Touch a number (1 - 9) for power level.
5. Touch **START**.

NOTE: To set **HI POWER** cooking, skip steps 3 and 4.

AUTOMATIC DEFROST

1. Touch **SHOWER DEFROST**.
2. Enter the weight of food in kg.
3. Touch **START**.
4. At pause, rearrange food.
5. Touch **START** to restart.

For your protection in the event of theft or loss of this product, please fill in the information below :

Serial No. _____

(Located on the front of the oven)

Model No. _____

(Located on the front of the oven)

Date of Purchase _____

Purchased Price _____

Where Purchased _____

SANYO

SANYO Electric Co., Ltd.

6/95 Printed in Singapore

Code No. 432-6-413S-87000