



## INSTRUCTION MANUAL

EM-X471

EM-X671

## Microwave Oven

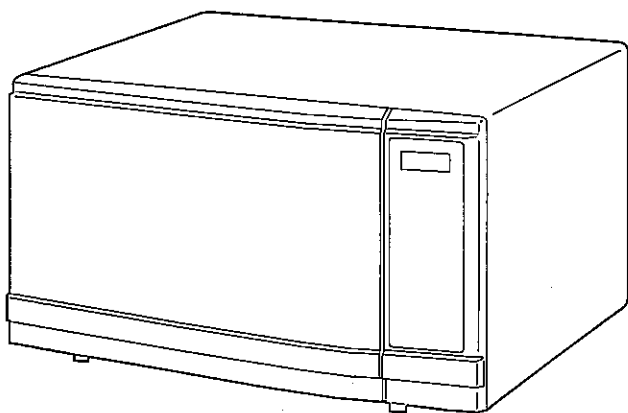

Read these instructions carefully before using your microwave oven. If you follow the instructions, your oven will provide you with many years of good service.

**SAVE THESE INSTRUCTIONS**

# PRECAUTIONS TO AVOID POSSIBLE EXPOSURE TO EXCESSIVE MICROWAVE ENERGY

- (a) Never interfere or tamper with safety interlocks.
- (b) Do not place any object between the oven front face and the door or allow soil or cleaner residue to accumulate on sealing surfaces. Wipe the door sealing area frequently with a mild detergent, rise and wipe dry. Never use abrasive powders or pads.
- (c) When open, the door must not be subjected to strain; for example, a child hanging on the opened door or any load on it could cause the oven to fall forward, and the weight could also damage the door.
- (d) Do not operate the oven if it is damaged. It is particularly important that the oven door close properly and that there is no damage to the:
  - (1) DOOR (bent)
  - (2) HINGES AND LATCHES (broken or loosened)
  - (3) DOOR SEALS AND SEALING SURFACES

## SPECIFICATIONS

Model:	EM-X471	EM-X671
Power Consumption:	1500W	1500W
Maximum Output:	1000W*	1000W*
Oven Capacity:	28L	37L
Turntable Diameter:	275 mm	320 mm
Dimensions: (w x h x d)	525 X 289 X 425 mm	550 X 317 X 457 mm
Weight: Approx.	17 kg	18.5 kg

**Specifications subject to change without notice.**

\*According to IEC-705 test procedures. The IEC-705 test procedure is an internationally recognized method of rating microwave wattage output.

## Please record your product's information

When you call to request service, you need to know your complete model number and serial number. Please fill in the information below. Please also record purchase date, price and where purchased.

**Model Number:** \_\_\_\_\_ (Located on the front of the oven)

**Serial Number:** \_\_\_\_\_ (Located on the front of the oven)

**Date of Purchase:** \_\_\_\_\_

**Purchase Price:** \_\_\_\_\_

**Where Purchased:** \_\_\_\_\_

**SAFETY**

■ Proper and Safe Use of Your Oven .....	4
■ Important Safety Instructions .....	5
■ Earthing Instructions .....	6
■ Utensils .....	6

**SET UP**

■ Names of Oven Parts and Accessories .....	8
■ Turntable Installation .....	8
■ Installation .....	9

**OPERATION**

■ Control Panel and Features .....	10
■ Setting Clock .....	11
■ Child Lock-Out .....	11
■ Kitchen Timer .....	12
■ Add 30 Seconds .....	12
■ Time Cooking .....	13
■ Direct Access Cooking .....	14
■ Automatic Defrost By Weight .....	16
■ Quick Reheating .....	18
■ Custom Programs .....	19
■ Menu Match .....	20
■ Optional Settings .....	21

**MAINTENANCE**

■ Troubleshooting .....	22
■ Questions and Answers .....	23
■ Cleaning .....	23

## PROPER AND SAFE USE OF YOUR OVEN

- The oven must be level.
- The turntable and turntable roller rest must be in the oven during cooking.
- Place the cookware gently on the turntable and handle it carefully to avoid possible breakage.
- The oven has several built-in safety switches to ensure that the power remains off when the door is open. Do not tamper with these switches.
- Do not operate the microwave oven when empty.
- Do not overcook food. A small quantity of food with low moisture content or high fat or sugar content can burn.
- Do not cook bacon directly on the turntable. Excessive local heating of the turntable may cause it to break.
- When heating food in plastic or paper containers, check the oven frequently due to the possibility of cause fires in the oven.
- Do not place liquids or other foods with sealed containers in the microwave oven, it may explode.
- Avoid heating baby bottles or baby food jars. Transfer the food into a suitable container for the microwave oven. The food temperature should be tested before giving it to the baby.
- Do not heat narrow-necked containers, such as syrup bottles.
- Do not attempt to deep-fry in your microwave oven as the temperature of oil cannot be controlled.
- Do not heat cans. Transfer the contents into a microwave-safe dish before heating.
- Do not use this microwave oven for commercial purposes. This microwave oven is made for household use only.

### NOTE

It is quite normal for steam to be emitted around the door, for misting to occur on the door, or even for water droplets to appear below the door during the cooking cycle. This is merely condensation from the heat of the food.

### WARNING -

- (a) Do not adjust or repair microwave oven yourself. Do not operate the oven if it is damaged, until it has been repaired by a service engineer trained by the manufacturer.
- (b) It is dangerous for anyone other than a properly qualified engineer trained by the manufacturer to carry out adjustments or repairs.
- (c) If the power cord is damaged, it must be replaced by a special prepared cord available from the Manufacturer or its Service Agent.
- (d) On no account remove or interfere with any parts or screws.  
**THIS COULD PROVE VERY DANGEROUS.**
- (e) Before use, the user should check that utensils are suitable for use in microwave ovens.

# IMPORTANT SAFETY INSTRUCTIONS

When using electrical appliances, basic safety precautions should be followed, including the following:

**WARNING -** To reduce the risk of burns, electric shock, fire, injury to persons or exposure to excessive microwave energy:

1. **Read all instructions before using.**
2. As with most cooking appliances, close supervision is necessary to reduce the risk of a fire in the oven cavity.
4. Use this oven only for its intended uses as described in the manual. It is not designed for industrial or laboratory use. Never use corrosive chemicals or vapours in this oven.

**If a fire should start or smoke is observed:**

- Keep the oven door closed
- Turn the oven off, and
- Disconnect the power cord or shut off power at the fuse or circuit breaker panel.

**Keep in mind the following rules at all times:**

- a. Do not overcook food. Overcooked food can cause fires in the oven. Carefully attend to the oven's activities, especially if paper, plastic, or other combustibles are inside.
- b. Do not store combustible items such as bread, cookies, paper products, etc. inside the oven. They may catch fire if turned on accidentally.
- c. Do not use wire twist-ties in the oven. Be sure to inspect purchased items for wire twist-ties and remove before placing food in the oven.
3. Some products such as eggs in the shell, water with oil or fat, sealed containers and closed glass jars may explode and therefore should not be heated in this oven.
5. As with any appliance, children should use the oven only under adult supervision.
6. Do not store or use this appliance outdoors.
7. Keep the oven away from heat and water sources. Exposure to heat and water can lower efficiency and lead to malfunctioning.
8. When heating water or other liquids, use a wide necked container to allow air bubbles to escape freely. Using narrow-necked containers may cause the liquid to boil over. This may happen even after the cooking has stopped.
9. It is important to keep the door and the oven interior clean. (See Cleaning instructions on page 23.)
10. To prevent delayed eruptive boiling of hot liquids and beverages or scalding, stir liquid before placing the container in the oven and again halfway through cooking time. Let stand in the oven for a short time and stir again before removing the container.

## SAVE THESE INSTRUCTIONS

# EARTHING INSTRUCTIONS

---

This appliance must be earthed. If there is an electrical short circuit, earthing reduces the risk of electric shock by providing an escape wire for the electric current. This appliance is equipped with a cord that has a earthing wire with a earthing plug. The plug must be plugged into an outlet that is properly installed and earthed.

The electrical power cord must be kept dry and must not be pinched or crushed in any way.

**WARNING - Improper use of the grounding plug can result in electric shock.**

## UTENSILS

---



### CAUTION

#### Personal Injury Hazard

- Tightly-closed utensils could explode. Closed containers are opened and plastic pouches pierced before cooking.

See next page for further instructions "Materials you can use in microwave oven or to be avoided in microwave oven."

There may be certain non-metallic utensils that are not safe to use for microwaving. If in doubt, you can test the utensil in question following the procedure below.

#### Utensil Test:

1. Fill a microwave-safe container with 1 cup of cold water (250 mL) along with the utensil in question.
2. Cook on **maximum power (P100)** for 1 minute.
3. Carefully feel the utensil.

If the empty utensil is warm, do not use it for microwave cooking.

**Do not exceed 1 minute testing time.**

## Materials you can use in microwave oven

Utensils	Remarks
Aluminum foil	Shielding only. Small smooth pieces can be used to cover thin parts of meat or poultry to prevent overcooking. <b>Arcing can occur if foil is too close to oven walls.</b> The foil should be at least 2.5 cm away from oven walls.
Browning dish	Follow manufacturer's instructions. The bottom of browning dish must be at least 5 mm above the turntable. Incorrect usage may cause the turntable to break.
Dinnerware	Microwave-safe only. Follow manufacturer's instructions. Do not use cracked or chipped dishes.
Glass jars	Always remove lid. Use only to heat food until just warm. Most glass jars are not heat resistant and may break.
Glassware	Heat-resistant oven glassware only. Make sure there is no metallic trim. Do not use cracked or chipped dishes.
Oven cooking bags	Follow manufacturer's instructions. Do not close with metal tie. Make slits to allow steam to escape.
Paper plates and cups	Use for short-term cooking/warming only. Do not leave oven unattended while cooking.
Paper towels	Use to cover food for reheating and absorbing fat. Use with supervision for a short-term cooking only.
Parchment paper	Use as a cover to prevent splattering or a wrap for steaming.
Plastic	Microwave-safe only. Follow the manufacturer's instructions. Should be labeled "Microwave Safe." Some plastic containers soften as the food inside gets hot. "Boiling bags" and tightly closed plastic bags should be slit, pierced or vented as directed by package.
Plastic wrap	Microwave-safe only. Use to cover food during cooking to retain moisture. Do not allow plastic wrap to touch food.
Thermometers	Microwave-safe only (meat and candy thermometers).
Wax paper	Use as a cover to prevent splattering and to retain moisture.

## Materials to be avoided in microwave oven

Utensils	Remarks
Aluminum tray	May cause arcing. Transfer food into microwave-safe dish.
Food carton with metal handle	May cause arcing. Transfer food into microwave-safe dish.
Metal or metal-trimmed utensils	Metal shields the food from microwave energy. Metal trim may cause arcing.
Metal twist ties	May cause arcing and could cause a fire in the oven.
Paper bags	May cause a fire in the oven.
Plastic foam cups	Plastic foam may melt or contaminate the liquid inside when exposed to high temperature.
Wood	Wood will dry out when used in the microwave oven and may split or crack.

## NAMES OF OVEN PARTS AND ACCESSORIES

Remove the oven and all materials from the carton.

Your oven comes with the following accessories:

Turntable	1
Turntable roller rest	1
Instruction Manual	1

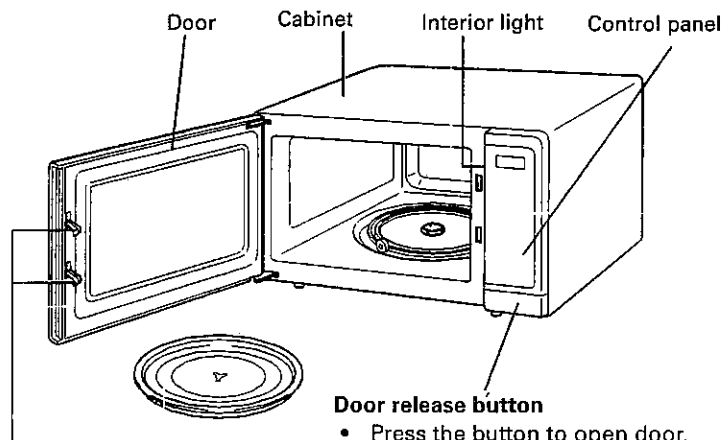

**Safety interlock system**  
Shuts off oven power if door is opened during operation.

### Door release button

- Press the button to open door.
- When you open the door during cooking process, the cooking stops without cancelling the program. Press **START** to resume cooking.

## TURNTABLE INSTALLATION

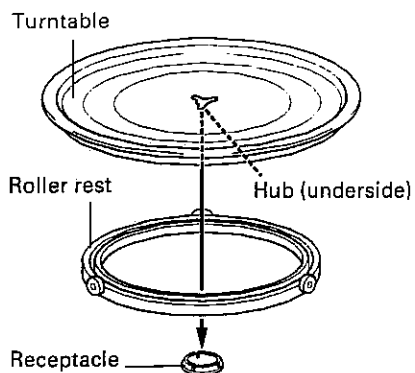

1. Place the roller rest on the cavity bottom.
2. Place the turntable on top of the roller rest as shown in the diagram. Make sure the turntable hub is securely locked in the receptacle.

- **Never place the turntable upside down.** The turntable should never be restricted.
- Both turntable and roller rest must always be used during cooking.
- All food and containers of food are always placed on the turntable for cooking.
- **The turntable returns to its original starting position** when cooking is finished. The light and fan will remain on but microwave power is turned off.
- The turntable rotates clockwise and counterclockwise; this is normal.
- If turntable or roller rest cracks or breaks, contact your nearest authorized service centre.



# INSTALLATION

Remove all packing material and accessories.

Examine the oven for any damage such as dents or a broken door.

Do not install if oven is damaged.

1. Select a level surface that provides enough open space for the inlet and/or outlet vents.
  - Leave a minimum clearance of 7.5 cm above the oven.
  - Do not remove the legs from the bottom of the oven to ensure proper air flow.
  - Blocking the inlet and/or outlet opening can damage the oven.
  - Do not install oven over a range, cooktop or other heat-producing appliance.
  - Place the oven as far away from radios and TV's as possible. Operation of microwave oven may cause interference to your radio, TV. Plug the microwave oven into a different outlet.
  - When the cabinet is covered with a protective film, remove the film to fully show the intended colour and finish.
2. Plug your oven into a standard household outlet.

When installing in a Built-in situation, you must allow a minimum of 7.5 cm on each side and the top and at the back of the microwave oven for ventilation. Failing to do so might cause damage to the microwave oven.

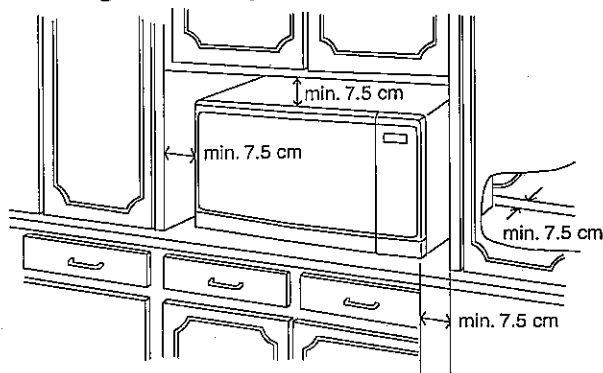

A minimum clearance of 7.5 cm is required between the oven and any adjacent walls including the back wall.

**CAUTION:** Use with care when handling oven. The control panel side of oven is heavy inside.

## CONTROL PANEL AND FEATURES

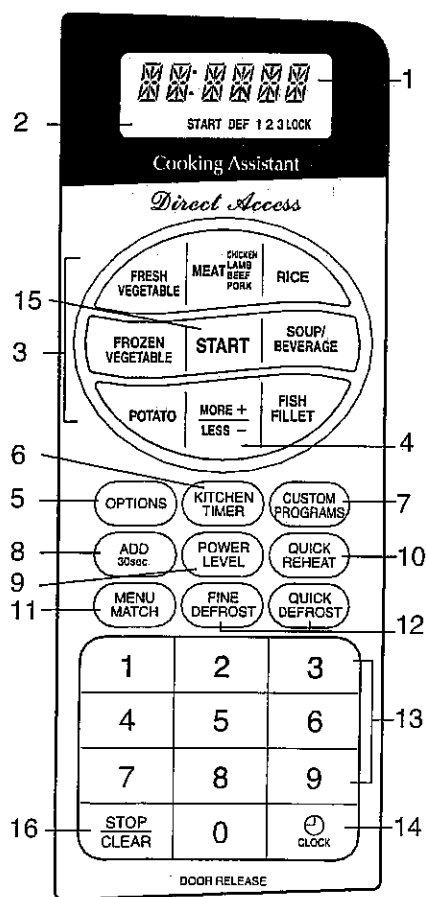
**(1) Display Window**

Counts down cooking time in seconds. Shows clock time when oven is not in use. Word Prompt display scrolls to guide you in setting clock and programming cooking courses.

**(2) Indicators**

**1/ 2/ 3:** Lights to indicate current cooking stage

**DEF:** Lights during Auto Defrost

**START:** Flashes to prompt you to press START.

**LOCK:** Lights to indicates the child-lock feature is set (page 11).

**(3) Direct Access keypads** (page 14)**(4) MORE/LESS**

Adds or reduces cooking time for Direct Access menu keypads.

**(5) OPTIONS** (page 21)

Allows you to customize the following oven feature settings: Word Prompt, Clock display, oven beeper and language selection.

**(6) KITCHEN TIMER** (page 12)**(7) CUSTOM PROGRAMS** (page 19)**(8) ADD 30 SEC.** (page 12)**(9) POWER LEVEL** (page 13)**(10) QUICK REHEAT** (page 18)**(11) MENU MATCH** (page 20)**(12) Auto Defrost by Weight** (page 16)

**FINE DEFROST:** Provides thorough defrosting results.

**QUICK DEFROST:** Provides faster defrosting when complete defrosting is less crucial.

**(13) Number keys****(14) CLOCK** (page 11)**(15) START****(16) STOP/CLEAR**

Clears all previous setting if pressed before cooking starts.

During cooking: press once to stop oven; twice to stop and clear all entries.



**Beep Sound**

A beep sounds when a keypad is pressed, to confirm your key entry. If desired, you can turn off beep sound. Refer to page 21.

## SETTING CLOCK

To set the time of day, follow the steps below.

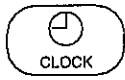
**Example:** To set 3:15:

<b>1</b>	Press <b>CLOCK</b> .	
<b>2</b>	Press <b>3</b> , <b>1</b> and <b>5</b> to enter time of day.	
<b>3</b>	Press <b>CLOCK</b> . The clock starts counting.	

- Note:
- If the clock (or display) shows any abnormality, unplug the oven from the AC outlet. Plug it in again and then reset the clock.
  - When your oven is plugged in for the first time or when power resumes after a power interruption, the word prompt display will guide you in setting the clock.
  - This is a 12-hour clock.
  - You can use the oven without setting clock.

## CHILD LOCK-OUT

The oven has a safety feature which prevents use by children. The feature locks the operation of the oven until canceled.

**To set:**

<b>1</b>	Press <b>START</b> and hold for 4 seconds. LOCK appears in the display.	
----------	--	---



**To cancel:**

<b>1</b>	Press <b>START</b> and hold for 4 seconds. LOCK disappears from the display.	
----------	---	---

## KITCHEN TIMER

You can use the Kitchen Timer function independently, even while a cooking program is going on in the oven.

**Example:** To set timer for 3 minutes:

<b>1</b>	Press <b>KITCHEN TIMER</b> .	
<b>2</b>	Press <b>3</b> , <b>0</b> and <b>0</b> to set 3 minutes. (up to 99 minutes 99 seconds)	
<b>3</b>	Press <b>START</b> . The timer starts counting and beeps for 7 seconds at the end.	



- Note:**
- After pressing **KITCHEN TIMER**, you have 10 seconds to enter time, or the setting will be cleared with a beep.
  - Press **STOP/CLEAR** to clear or change a Kitchen Timer setting.
  - When cooking or defrosting time appears with a flashing letter **K** in the display, this indicates that the Kitchen Timer is in operation.
  - A steady letter **K** in display indicates that only the Kitchen Timer is in use.
  - To check remaining time on Kitchen Timer during cooking/defrosting, press **KITCHEN TIMER**. The remaining time will appear in the display for 5 seconds.
  - To stop Kitchen Timer beeping, press **KITCHEN TIMER**.
  - If oven and Kitchen Timer stop at the same time, only the oven will beep.
  - If cooking completes while you are setting the Kitchen Timer, all settings are cleared. Restart from step 1.
  - After entering time in step 2, Kitchen Timer will automatically begin after 5 seconds if **START** is not pressed.

## ADD 30 SECONDS

This feature provides 2 functions:

- Allows you to cook for only 30 seconds on P100 (maximum power).
- Allows you to extend a cooking time by 30 seconds during Time Cooking without pressing **START**. You can repeat this option up to 3 times.

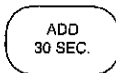
**Example:** To set 30-second cooking:



<b>1</b>	Press <b>ADD 30 SEC.</b> once.	
<b>2</b>	Press <b>START</b> . The display shows time countdown.	

**Note:** This feature cannot be used during Direct Access Cooking or Auto Defrost by weight.

## TIME COOKING

This basic microwave cooking method allows you to cook food for a desired time. The oven can be programmed to cook for up to 99 minutes 99 seconds. In addition to the maximum power level (**P100**), you can select different microwave power from 10 levels, **P 0** to **P90** (0-90% of total power level).

**Example:** To cook at power level **P80** for 40 seconds:

<b>1</b>	Enter 40 seconds by pressing <b>4</b> and <b>0</b> .	
<b>2</b>	Press <b>POWER LEVEL</b> until <b>P80</b> appears in the display.	
<b>3</b>	Press <b>START</b> .	

Note:

- If no power level is entered, the power level will always be **P100** (100%).
- Foods with high moisture content should be cooked on **P100** power.
- To check the power level during cooking, press **POWER LEVEL**.

### POWER LEVEL SETTING GUIDE

**P100** • Cooking poultry, vegetables, and most casseroles. Boiling water.  
• Preheating a browning dish.

#### **P50 Medium**

- Cooking custards and pasta.
- Cooking rump roast, ham, veal, lamb.

**P90** • Reheating rice and pasta.

**P40** • Cooking less tender cuts of meat in liquid or slow-cooking dishes.  
• Completing the cooking cycle of less tender roasts.

**P80** • Reheating precooked or prepared food quickly.  
• Cooking fish.

#### **P30 Med. Low**

- Completing the cooking cycle of casseroles, stews, sauces.
- Time defrosting.

**P70 Med. High**  
• Cooking cheese dishes.

**P20** • Softening chocolate.  
• Clarifying butter.  
• Heating breads, rolls, pancakes, tacos, tortillas, French toast.

**P60** • Cooking scrambled eggs.  
• Baking cakes.

**P10** • Softening cream cheese, butter.  
• Keeping casseroles warm.

### Time Defrosting:

Use power level **P30** (Medium Low). For most frozen foods, allow approximately 5 minutes per 500 g. To speed up the defrosting of dense foods over 500 g, you may start on **P100** for **2 minutes**. Then reduce to the power level **P30** and enter remaining time.

### Multistage Cooking:

You can program oven for 3 cooking stages. Each stage can be programmed with a different power level and time. To program 2-stage or 3-stage cooking, repeat the Time Cooking steps 1 and 2 and press **START**. The oven will automatically proceed to the end of cooking stages.



### Delay Start Cooking:

You can delay the time when you want cooking to start. Cooking can be delayed up to 99 minutes and 99 seconds. To delay cooking, follow procedure for multistage cooking, but for stage1 use power level **P 0**.

## DIRECT ACCESS COOKING

Direct Access Cooking allows you to reheat or cook food automatically without entering power level or time. Choose the appropriate food keypad (except Meat) and press 1 - 3 times, depending on the serving size, and press **START**. For Direct Access Meat menu, press **MEAT** keypad 1 - 4 times to select type of Meat first and then enter weight of meat in kilogram, and press **START**.

**Example:** To cook 1.2 kg of Lamb:

<b>1</b>	Press <b>MEAT</b> twice.	
<b>2</b>	Enter the weight of meat in kilogram.	
<b>3</b>	Press <b>START</b> . The time counts down in the display.	

### Direct Access Cooking Serving sizes/ Type of Meat:

Food Keypad	Press Food Keypad			
	once	twice	3 times	4 times
<b>FRESH VEGETABLE</b>	1 serving (150 g)	2 servings (300 g)	3 servings (450 g)	-
<b>MEAT</b>	CHICKEN	LAMB	BEEF	PORK
<b>RICE</b>	1 serving (125 mL)	2 servings (250 mL)	3 servings (375 mL)	-
<b>FROZEN VEGETABLE</b>	1 serving (150 g)	2 servings (300 g)	3 servings (450 g)	-
<b>SOUP/BEVERAGE</b>	1 serving (230 mL)	2 servings (460 mL)	3 servings (690 mL)	-
<b>POTATO</b>	1 serving (170 g)	2 servings (340 g)	3 servings (510 g)	-
<b>FISH FILLET</b>	1 serving (170 g)	2 servings (340 g)	3 servings (510 g)	-

### Meat Cooking Techniques:

- The oven stops about halfway through cooking process to allow for checking, turning or rearranging the food. Open the door and rearrange the food. The oven restarts after 5 minutes to the end if you do not open the door.
- This meat menu is an accurate cooking method for meat from 0.5 kg up to 2.5 kg.
- The oven selects 1 kg if a weight is not entered.

### MORE/LESS TIME ADJUSTMENT

The **MORE/LESS** keypad allows fine adjustments in Direct Access Cooking by either increasing or decreasing the preprogrammed cooking time.

You can change the cooking time by pressing **MORE/LESS** key once or twice before pressing **START**.

To increase the time, press **MORE/LESS** once, and press **START**.

To decrease the time, press **MORE/LESS** twice, and press **START**.

**COOKING/REHEATING TIPS**

**FRESH VEGETABLE**

- Weight shown is for washed, prepared vegetables.

**MEAT**

- Doneness varies with meat of different shape and weight.
- Meat should be completely thawed before cooking.
- Place meat on a microwave-safe roasting rack in a dish.
- All meat may be seasoned as desired before cooking.
- Use wax paper or plastic wrap to stop splattering.
- Aluminium foil can be used to cover thin parts of meat or chicken wings and legs to prevent overcooking. Foil should be applied at pause.
- While chicken or meat is standing, cover with foil to keep in the heat.

**FROZEN VEGETABLE**

- Follow package directions for venting package, adding water, piercing pouch, replacing foil, covering with plastic wrap, etc. For larger portions, stir during cooking.

**SOUP/BEVERAGE**

- Soups or beverages must be at room or refrigerator temperature for reheating.

**POTATO**

- Arrange in a circular pattern with heavier ends pointing toward the outer edge of the dish. Rotate and turn over during cooking.

**FISH FILLET**

- Fish should be completely thawed before cooking. Arrange fillet in a single layer in dish.

**Direct Access Cooking/Reheating Guide**

Item	Special Notes																				
Fresh Vegetable	Place in a suitable sized microwave-safe dish. Add 1 tbsp. water per serving. Cover. Let stand 2 - 3 minutes.																				
Meat	<p><b>Chicken, whole:</b> Remove the giblets, rinse in cold water and pat dry. Tie legs together with string. Place breast side down on a roasting rack. Turn over at pause. Let stand 10 - 20 minutes.</p> <p><b>Chicken, pieces:</b> Arrange pieces skin side down. Turn and rearrange at pause. Let stand 5 - 10 minutes.</p> <p><b>Lamb, Beef, Pork:</b> Tie meat with string. Place meat fat side down on a roasting rack. Turn over at pause. Let stand 10 - 20 minutes.</p>																				
Rice (long grain)	<p>Cook with water and salt in a deep dish. Use appropriate size casserole. Cover. Stir and let stand for 5 minutes.</p> <table border="1"> <thead> <tr> <th></th> <th>Rice</th> <th>Water</th> <th>Salt</th> <th>Container Size</th> </tr> </thead> <tbody> <tr> <td>1</td> <td>1/2 cup</td> <td>1 cup (250 mL)</td> <td>1/4 tsp. (1 mL)</td> <td>1 1/2 litre</td> </tr> <tr> <td>2</td> <td>1 cup</td> <td>1 3/4 cup (425 mL)</td> <td>1/2 tsp. (2 mL)</td> <td>2 litre</td> </tr> <tr> <td>3</td> <td>1 1/2 cups</td> <td>2 1/2 cups (625 mL)</td> <td>3/4 tsp. (4 mL)</td> <td>3 litre</td> </tr> </tbody> </table>		Rice	Water	Salt	Container Size	1	1/2 cup	1 cup (250 mL)	1/4 tsp. (1 mL)	1 1/2 litre	2	1 cup	1 3/4 cup (425 mL)	1/2 tsp. (2 mL)	2 litre	3	1 1/2 cups	2 1/2 cups (625 mL)	3/4 tsp. (4 mL)	3 litre
	Rice	Water	Salt	Container Size																	
1	1/2 cup	1 cup (250 mL)	1/4 tsp. (1 mL)	1 1/2 litre																	
2	1 cup	1 3/4 cup (425 mL)	1/2 tsp. (2 mL)	2 litre																	
3	1 1/2 cups	2 1/2 cups (625 mL)	3/4 tsp. (4 mL)	3 litre																	
Frozen Vegetable	Place in a suitable sized microwave-safe dish. Cover. Let stand 2 - 3 minutes.																				
Soup/Beverage	<p><b>Coffee/Tea/Hot Chocolate:</b> No cover. Stir after reheating.</p> <p><b>Soup:</b> Cover. Stir after reheating.</p>																				
Potato	Wash and scrub well. Pierce with fork. Place on paper towel. Turn over during cooking. Let stand 3 - 5 minutes. Do not place in centre of turntable.																				
Fish Fillet	<b>Fish fillet/ Fish steaks:</b> Use microwave-safe shallow dish or pie plate. Cover lightly with plastic wrap.																				





## AUTOMATIC DEFROST BY WEIGHT

Automatic Defrost allows you to easily defrost food. Power levels and times are automatically determined when the food weight is entered.

**FINE DEFROST:** Use for thorough defrosting of larger, dense frozen foods, when it is important to have the centre section defrosted as well as the outside. Ideal for items such as roasts, whole chicken and steak.

**QUICK DEFROST:** Use to assist separation of frozen pieces of chicken or fish that need preparation prior to cooking. Excellent for defrosting ground meat for use in spaghetti sauce or taco meat.

**Example:** To thoroughly defrost a 2.5 kg whole chicken:

<b>1</b>	Press <b>FINE DEFROST</b> .	
<b>2</b>	Enter the weight of food in kilogram.	 
<b>3</b>	Press <b>START</b> . Total defrost time appears in the display.	

### Defrosting Techniques:

- Remove freezer paper, plastic wrap or foil wrap. Place food in a microwave-safe dish.
- To prevent thin parts and edges from becoming too warm and cooking before centre of food is defrosted, shield with small pieces of aluminium foil.
- Because some foods will still be icy in the centre, it is necessary to have a standing time after defrosting the food in the oven. Food should be taken out of the oven to complete defrosting. A longer standing time might be required for denser foods such as roasts.
- To defrost items not listed in defrosting chart, use Time defrosting (see page 13).
- The FINE DEFROST includes preset standing time.

**Note:** • Maximum weight for defrosting is 2.9 kg.

- The oven selects 1 kg if a weight is not entered.
- **Beep tone sounds 5 times during the defrosting cycle to signal that food should be rearranged to improve defrosting performance.** Open the door and rearrange the food. The oven continues the defrosting cycle to the end if you do not open the door.
- Food can be defrosted in a styrofoam package.
- If weight of food is stated in pounds and ounces, it must be converted to kilograms.

### Conversion Table

lbs - oz.	kg	lbs - oz.	kg
4 oz.	0.1	3 lb-9 oz.	1.6
7 oz.	0.2	3 lb-12 oz.	1.7
10 oz.	0.3	4 lb	1.8
14 oz.	0.4	4 lb-3 oz.	1.9
1 lb-2 oz.	0.5	4 lb-7 oz.	2.0
1 lb-5 oz.	0.6	4 lb-10 oz.	2.1
1 lb-9 oz.	0.7	4 lb-14 oz.	2.2
1 lb-12 oz.	0.8	5 lb-1 oz.	2.3
2 lb	0.9	5 lb-5 oz.	2.4
2 lb-4 oz.	1.0	5 lb-8 oz.	2.5
2 lb-7 oz.	1.1	5 lb-12 oz.	2.6
2 lb-11 oz.	1.2	5 lb-15 oz.	2.7
2 lb-14 oz.	1.3	6 lb-3 oz.	2.8
3 lb-2 oz.	1.4	6 lb-6 oz.	2.9
3 lb-5 oz.	1.5		





**DEFROSTING CHART**

<b>Item</b>	<b>During Defrosting</b>
<b>Beef</b>	
Ground beef	Turn over. Remove defrosted portion.
Liver	Drain liquid. Separate pieces.
Roasts	Turn over. Cover ends with foil.
Sirloin steak	Turn over.
Rib or T-bone	Turn over.
Flank steak	Turn over.
Stewing meat	Break apart.
<b>Pork</b>	
Ground pork	Turn over. Remove defrosted portion.
Bacon	Defrost in original wrapper. Turn over.
Chops	Separate and turn over.
Ribs	Turn over.
Roasts	Turn over. Cover ends with foil.
<b>Lamb</b>	
Ground lamb	Turn over. Remove defrosted portion.
Chops	Separate. Turn over.
Ribs	Turn over.
Roasts	Turn over. Cover ends with foil.
<b>Poultry</b>	
Chicken, whole	Turn over. Cover ends with foil. Rinse under cold water after defrosting.
Pieces	Separate. Turn over.
Cornish hens	Turn over. Cover ends with foil. Rinse under cold water after defrosting.
<b>Fish and Seafood</b>	
Crabmeat, Shrimp	Break apart.
Fish fillets	Turn over. Rearrange. Rinse under cold water to separate after defrosting.
Fish whole	Turn over. Cover head and tail with foil.
Steaks	Turn over.
Scallops	Break apart. Remove defrosted seafood.

## QUICK REHEATING

A time-saving feature, this simplified control lets you quickly set and start microwave cooking without pressing **START**.

**Example:** To set Quick Reheating for 2 minutes:

<b>1</b>	Press <b>QUICK REHEAT</b> .	
<b>2</b>	Press <b>2</b> . The display shows time counting down.	

- Note:
- To cook for 30 seconds, press **0**. To cook for 1 to 9 minutes, press the corresponding number key (**1 - 9**).
  - This feature only cooks at highest power level (P100).

### QUICK REHEATING AND COOKING CHART

Reheating	Amount	Time	Special Notes
<b>Meat</b>			
Chili, stews	2 cups	3 - 4 min.	Place in microwave-safe dish. Cover. Stir halfway through cooking time.
Hamburgers, meat loaf slices	1 serving 2 servings	$\frac{1}{2}$ - 1 min. 1 - 2 min.	Place on microwave-safe plate. Cover with paper towel. Turn over once.
<b>Poultry</b>			
Chicken pieces	2 4	1 - 2 min. 2 - 3 min.	Heat on microwave-safe plate. Cover with wax paper. If fried, cover with paper towel.
Chicken, turkey, sliced	85 - 140 g	1 - 2 min.	Heat on microwave-safe plate. Cover with wax paper.
<b>Cooked rice, pasta</b>	1 cup (250 mL) 2 cups (500 mL)	1 - 2 min. 2 - 3 min.	Heat in microwave-safe casserole, covered with plastic wrap.
<b>Canned vegetable</b>	230 g 425 g	1 - 2 min. 2 - 3 min.	Use microwave-safe casserole, covered. Stir once.
Cooking	Amount	Time	Special Notes
<b>Mashed potatoes instant</b>	4 servings	3 - 5 min.	Follow package directions. Reduce liquid by 1 tbsp (15 mL).
<b>Pudding and pie filling mix</b>	90 g	4 - 6 min.	Follow package directions. Stir once.
<b>Cereals</b>			
Cream of wheat (regular)	$\frac{1}{4}$ cup (50 mL)	1 - 2 min.	Add $\frac{3}{4}$ cup (175 mL) of water. Cook uncovered. Stir once. Let stand for 1 minute.







## CUSTOM PROGRAMS

For food/recipes prepared most often, you can easily custom program your own sequences or cooking stages (power levels/cooking times). You can set 3 different custom programs (No.1, No.2 and No.3). Each program may have 1 - 3 cooking stages.

For example, you frequently cook 1 cup long-grain rice. For Stage 1 you use 100% power for 5 minutes to bring water to a boil. You then add rice, salt and butter and for Stage 2 you use 30% power for 20 minutes to cook rice. To set these 2 cooking sequences in the first Custom Program (No.1):



Stage 1 for 5 minutes at P100 (100% power)

Stage 2 for 20 minutes at P30 (30% power)



<b>1</b>	Press <b>CUSTOM PROGRAMS</b> once. No.1 appears in the display.	
<b>2</b>	Press <b>5, 0</b> and <b>0</b> to enter 5 minutes.	
<b>3</b>	Press <b>POWER LEVEL</b> once to select P100.	
<b>4</b>	Press <b>2, 0, 0</b> and <b>0</b> to enter 20 minutes.	
<b>5</b>	Press <b>POWER LEVEL</b> repeatedly until P30 appears in display.	
<b>6</b>	Press <b>CUSTOM PROGRAMS</b> once. The Custom Program No.1 is now programmed into the microwave memory.	

OPERATION

### To use a Custom Program:

<b>1</b>	Once programming is completed, you can call up any of your Custom Programs (No.1, No.2 or No.3) by pressing the <b>CUSTOM PROGRAMS</b> keypad once, twice or 3 times.	
<b>2</b>	Press <b>START</b> .	

### To delete a Custom Program:



<b>1</b>	Call up the Custom Programs(No.1, No.2 or No.3) you want to delete by pressing <b>CUSTOM PROGRAMS</b> .	
<b>2</b>	Press <b>0</b> and then <b>CUSTOM PROGRAMS</b> .	

- Note:
- For custom programming, only Time Cooking can be used.
  - For more details, see page 13 for multi-stage cooking.

## MENU MATCH

This feature allows you to prepare packaged foods perfectly with no guess work. For instance, frozen food instructions may specify to reheat the item on MED, LOW, or in a 700W microwave oven. To compensate for the higher wattage of this microwave oven, the cooking time and power levels will be automatically adjusted when Menu Match is used.

**Example:** To cook a frozen entree that requires 3-minutes cooking in a 700W oven:

Step	Procedure	Keypad														
<b>1</b>	Press <b>MENU MATCH</b> five times to enter the manufacturer's recommended power level, 700W. <table border="1" data-bbox="233 395 521 612"><thead><tr><th>Press</th><th>Power Level</th></tr></thead><tbody><tr><td>once</td><td>HIGH</td></tr><tr><td>twice</td><td>MEDIUM</td></tr><tr><td>3 times</td><td>LOW</td></tr><tr><td>4 times</td><td>800W</td></tr><tr><td>5 times</td><td>700W</td></tr><tr><td>6 times</td><td>600W</td></tr></tbody></table>	Press	Power Level	once	HIGH	twice	MEDIUM	3 times	LOW	4 times	800W	5 times	700W	6 times	600W	
	Press	Power Level														
once	HIGH															
twice	MEDIUM															
3 times	LOW															
4 times	800W															
5 times	700W															
6 times	600W															
<b>2</b>	Press <b>3, 0</b> and <b>0</b> to enter the manufacturer's recommended defrosting time. 															
<b>3</b>	Press <b>START</b> . <b>ADJUST</b> appears and a beep sounds. The cook time display changes to the actual time adjusted by the oven and counts down in the display.															

- Note:
- For a range of time (such as 5 - 7 minutes), use 6 minutes.
  - If the instructions do not specify a power level, use **HIGH**.
  - Closely watch the cooking/defrosting progress when preparing an item for the first time.
  - When **MED-HIGH** power is called for, use **MED** level. Add more time to the suggested cooking time on the package, if necessary.
  - Two stages of food preparation can be programmed at one time using Menu Match feature. Repeat steps 1 - 2, and then press **START**.



## OPTIONAL SETTINGS

The **OPTIONS** key allows you to customize the following four oven feature settings as shown below.

### Optional Features:

Features	Press keypad	Press number
<b>Word Prompt on/off</b> The Word Prompt may be turned on or off*.	once	1-ON 2-OFF *Prompt words may be shortened.
<b>Clock on/off</b> The clock display can be turned off and back on.	twice	1-ON 2-OFF
<b>Beep on/off</b> The beep sound may be turned off and back on.	3 times	1-ON 2-OFF
<b>Language selection</b> You can select from English or Spanish for display.	4 times	1-ENGLISH 2-ESPAÑOL

**Example:** To select Spanish for Word Prompt display:

Step	Procedure	Keypad
1	Press <b>OPTIONS</b> 4 times until language choice prompt appears: 1-ENGLISH 2-ESPANOL	
2	Press 2 to select Spanish	

- Note:
- The oven is initially set with word prompt display, clock display and beep sound on.
  - When first plugged in, the oven will automatically display English in the Word Prompt display

## TROUBLESHOOTING

Check your problem by using the chart below and try the solutions for each problem. If the microwave oven still does not work properly, contact the nearest authorized service centre.

<b>TROUBLE</b>	<b>POSSIBLE CAUSE</b>	<b>POSSIBLE REMEDY</b>
Oven will not start.	<ul style="list-style-type: none"> <li>• Electrical cord for oven is not plugged in.</li> <li>• Door is open.</li> <li>• Wrong operation is set.</li> </ul>	<ul style="list-style-type: none"> <li>• Plug into the outlet.</li> <li>• Close the door and try again.</li> <li>• Check instructions, (pages 11-21)</li> </ul>
Arcing or sparking.	<ul style="list-style-type: none"> <li>• Materials to be avoided in microwave oven are used.</li> <li>• The oven is operated when empty.</li> <li>• Spilled food remains in the cavity.</li> </ul>	<ul style="list-style-type: none"> <li>• Use microwave-safe cookware only. (page 7)</li> <li>• Do not operate with oven empty.</li> <li>• Clean cavity with wet towel.</li> </ul>
Unevenly cooked foods.	<ul style="list-style-type: none"> <li>• Materials to be avoided in microwave oven are used.</li> <li>• Food is not defrosted completely.</li> <li>• Cooking time, power level is not suitable.</li> <li>• Food is not turned or stirred.</li> </ul>	<ul style="list-style-type: none"> <li>• Use microwave-safe cookware only. (page 7)</li> <li>• Completely defrost food.</li> <li>• Use correct cooking time, power level.</li> <li>• Turn or stir food.</li> </ul>
Overcooked foods.	<ul style="list-style-type: none"> <li>• Cooking time, power level is not suitable.</li> </ul>	<ul style="list-style-type: none"> <li>• Use correct cooking time, power level.</li> </ul>
Undercooked foods.	<ul style="list-style-type: none"> <li>• Materials to be avoided in microwave oven are used.</li> <li>• Food is not defrosted completely.</li> <li>• Oven ventilation ports are restricted.</li> <li>• Cooking time, power level is not suitable.</li> </ul>	<ul style="list-style-type: none"> <li>• Use microwave-safe cookware only. (page 7)</li> <li>• Completely defrost food.</li> <li>• Check to see that oven ventilation ports are not restricted.</li> <li>• Use correct cooking time, power level.</li> </ul>
Improper defrosting.	<ul style="list-style-type: none"> <li>• Materials to be avoided in microwave oven are used.</li> <li>• Cooking time, power level is not suitable.</li> <li>• Food is not turned or stirred.</li> </ul>	<ul style="list-style-type: none"> <li>• Use microwave-safe cookware only. (page 7)</li> <li>• Use correct cooking time, power level.</li> <li>• Turn or stir food.</li> </ul>
<b>ERROR</b> message appears in the display.	<ul style="list-style-type: none"> <li>• Wrong operation is set.</li> </ul>	<ul style="list-style-type: none"> <li>• Check instructions, (pages 11-21)</li> </ul>

## QUESTIONS AND ANSWERS

- Q. When the oven is plugged into a wall outlet for the first time, it does not work properly. What is wrong?
- A. The microcomputer used in the oven control may temporarily become scrambled and fail to function as programmed. Unplug the oven from the wall outlet and then plug it back in. The microcomputer will then reset for proper functioning.
- Q. Why is there noise coming from the turntable when the oven is turned on?
- A. This noise occurs when the turntable roller rest and cavity bottom are dirty. Clean the turntable roller rest cavity bottom. Frequent cleaning of these parts should eliminate or reduce the noise.
- Q. Why is there noise coming from the oven when using a lower power level?
- A. When cooking with power other than P100, the oven automatically turns on and off to obtain lower power output. The clicking noise can be heard when the oven switches on and off. This is normal.
- Q. Why is there steam coming out of the air exhaust vent?
- A. Steam is produced during cooking. The microwave oven has been made to vent this steam.
- Q. What is wrong when the oven light will not glow?
- A. There may be several reasons why the oven light will not glow. The light bulb has burned out or **START** has not been pressed.
- Q. Why do eggs sometimes pop?
- A. The egg yolk may pop because of steam build-up inside the membrane. Pierce the membrane with a toothpick before cooking it. **Never microwave eggs in the shell since they may explode.**
- Q. How are boil-overs avoided?
- A. Use a larger utensil than usual for cooking. If you open the oven door or touch **STOP/CLEAR**, the food will stop boiling.

## CLEANING

Wipe the oven inside and outside with a soft cloth and a mild detergent solution. Then rinse and wipe dry. This should be done on a weekly basis, more often if needed. Never use cleaning powders or rough pads. Excessive oil splatters on the inside top will be difficult to remove if left for many days. Wipe splatters with a wet paper towel, especially after cooking chicken or bacon.

### REMOVABLE PARTS

The following parts may be removed as described. They should be washed in warm (not hot) water with a mild detergent and a soft cloth. Once they are clean, rinse them well and dry with a soft cloth. Never use cleaning powders, steel wool or rough pads.

- The turntable may be cleaned at the sink. Be careful not to chip or scratch the edges as this may cause the turntable to break during use.
- The turntable roller rest should be cleaned regularly.

### SPECIAL CARE

For best performance and safety, the inner door panel and the oven front frame should be free of food or grease buildup. Wipe them often with a mild detergent. Then rinse and wipe dry. Never use cleaning powders or rough pads.

After cleaning the control panel, press **STOP/CLEAR** to clear any entries that might have been entered accidentally while cleaning the panel.

## QUICK REHEATING

### DIRECT ACCESS COOKING

1. Press **FRESH VEGETABLE, RICE, FROZEN VEGETABLE, SOUP/BEVERAGE, POTATO or FISH FILLET**  
1 - 3 times until desired number of servings appears or **MEAT**  
1 - 4 times until your desired type of meat appears.
2. Enter weight of food in kilogram for meat menu.
3. If desired, press **MORE/LESS** once or twice.  
Press once for increased cooking time.  
Press twice for decreased cooking time.
4. Press **START**.

NOTE: For Direct Access meat menu, the oven stops about halfway through cooking. The oven restarts after 5 minutes to the end if you do not open the door.

### CHILD LOCK-OUT

To set:

1. Press and hold **START** for 4 seconds. Indicator **LOCK** lights.

To cancel:

1. Press and hold **START** for 4 seconds. Indicator **LOCK** disappears.

### QUICK REHEATING

(Hi-power only)

1. Press **QUICK REHEAT**.
2. Press a number (0-9) for cooking time.

NOTE: To set Quick Reheating for 30 seconds, press **QUICK REHEAT** and 0.

### TIME COOKING

1. Press numbers for cooking time (in minutes and seconds).
2. Press **POWER LEVEL** until desired power level (P100 - P 0) appears in the display.
3. Press **START**.

### AUTO DEFROST

1. Press either **FINE DEFROST** or **QUICK DEFROST**.
2. Enter the weight of food in kg.
3. Press **START**.
4. At pause, rearrange food.
5. Press **START** to restart.

NOTE: If you do not open the door at the Pause, the oven continues to complete the defrosting.

### CLOCK

1. Press **CLOCK**.
2. Press numbers to set time.
3. Press **CLOCK**.

### KITCHEN TIMER

1. Press **KITCHEN TIMER**.
2. Press numbers for desired time.
3. Press **START**.

### ADD 30 SECONDS

1. Press **ADD 30 SEC**.
2. Press **START**.

NOTE: If you use **ADD 30 SEC** while cooking, you do not need to press **START**. The oven allows you to use **ADD 30 SEC** up to 3 times while oven is in operation.

### CUSTOM PROGRAMS

To set your custom program:

1. Press **CUSTOM PROGRAMS** 1 - 3 times to select program.
2. Press numbers for cooking time (in minutes and seconds).
3. Press **POWER LEVEL** until desired power level (P100 - P 0) appears in the display. To program 2 or 3 stage cooking, repeat steps 2 and 3.
4. Press **CUSTOM PROGRAMS**.

NOTE: Only Time cooking can be used.

To use your program:

1. Press **CUSTOM PROGRAMS** 1 - 3 times to select your desired program.
2. Press **START**.

To delete program:

1. Press **CUSTOM PROGRAMS** 1 - 3 times to select program you want to delete.
2. Press 0.
3. Press **CUSTOM PROGRAMS**.

### MENU MATCH

1. Press **MENU MATCH** 1 - 6 times until the power level shown on the food package appears:  
**HIGH**  
**MEDIUM**  
**LOW**  
**800W**  
**700W**  
**600W**
2. Enter the required cook time shown on the package.
3. Press **START**.

# SANYO

SANYO Electric Co., Ltd.

6/99 Printed in Singapore

Code No. 432-6-414S-73700