

INSTRUCTION MANUAL  
使用说明书

**SANYO** 三洋

SC 800

**VACUUM CLEANER**

吸尘器

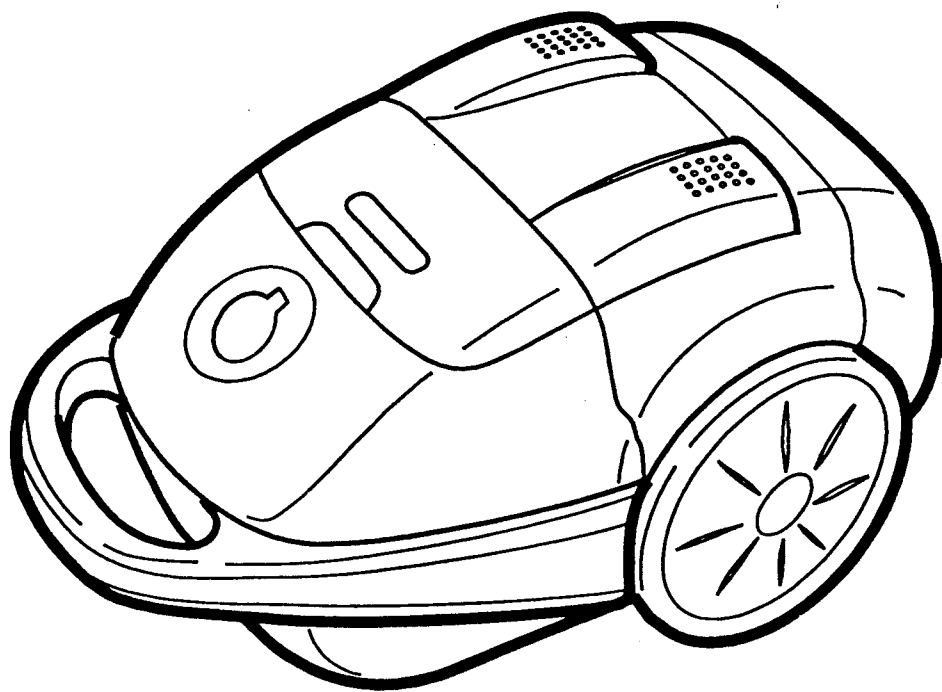

**NAME AND FUNCTION OF PARTS (Assemble as indicated in the center illustration.) / 部件名称和功能 (如中央图示进行组装)**

**Vacuum Power Adjustment Ring / 吸尘功率调节环**

- The full vacuum power of the cleaner may be too strong in certain cases, for instance when vacuuming curtains and draperies. In these cases, turn the vacuum power adjustment ring (on the hose) to control the vacuum power. Match the hole in the ring with the hose hole to reduce the power.
- 对于某些材料, 如窗帘和绸缎呢绒等来说, 全吸尘功率可能会太强, 在这种情况下, 转动吸尘功率调节环(在软管上)以调节吸尘功率。当调节环上的小孔与软管上的小孔对准时, 吸尘功率就会变小。

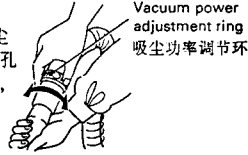

**Dust Indicator / 灰尘指示灯**

- The dust indicator shows the amount of dust that has collected in the dust compartment. Hold the floor nozzle away from the floor, while operating to check.
- 灰尘指示器指示集尘室内收集的灰尘数量。在进行检查时, 请将吸尘头提起使其离开地板。

DUST INDICATOR  
灰尘指示灯



- Vacuuming can continue.
- 表示能继续进行吸尘。

DUST INDICATOR  
灰尘指示灯



- Suction power decreases. The cloth bag or paper bag should be emptied.
- 吸尘功率下降, 应腾空布袋或纸袋。

**Cord Rewind Button / 电源线卷回钮**

- To pull the cord back into the unit, press the cord rewind button.

**Caution:**

- Hold the plug when rewinding the cord so that the plug does not damage furniture, hands, the vacuum cleaner or the cord by hitting them. Holding the plug will make rewinding smoother.

- 要将电源线卷回到机内时, 请按电源线卷回钮。

**注意:**

- 在卷回电源线时应握住电源插头, 以免插头撞击到家具、手、吸尘器或电源线而使它们受到损伤。握住插头能确保平稳地卷绕。

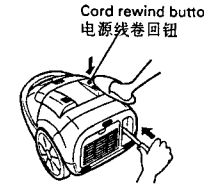

**Unclogging the Hose / 清理软管**

- When the hose is clogged with dust, remove it in the following manner:

- 1) Pull out the angled pipe by turning the removal ring in either direction.
  - 2) Use a vinyl garden hose to push out the dust clogging the hose.
  - 3) Insert the angled pipe in place and return the ring to its original position.
- Do not use the hose without the angled pipe in place. If the hose is used without the angled pipe, the hose will bend excessively, causing it to break.

- 当软管被灰尘堵塞时, 请按下述方法来清除灰尘:
- 1) 朝任一方向转动拆卸环来拉出弯管。
  - 2) 用乙烯软管推出堵在软管内的灰尘。
  - 3) 将弯管插入到位, 把环转回到原来位置。
- 请勿在没有装上弯管的情况下使用软管。如果没有弯管就使用软管, 则软管可能会极度弯曲而引起破裂。

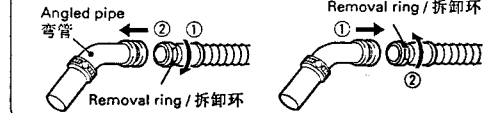

**Floor Nozzle / T型吸尘头**

- The two-way floor nozzle has lever with two positions.
- 两用T型吸尘头具有双位控制杆。

**FLOOR:**  
For vacuuming wooden floors, linoleum or plastic covered floors.  
FLOOR: 用于木质地板、亚麻油毡或塑料铺面地板的吸尘。

**RUG:**  
For vacuuming rugs and carpets.  
RUG: 用于厚毛毯和地毯的吸尘。

**Attachments / 附件**

**Crevice tool / 尖嘴头**

- For vacuuming edges and gaps.
- 适于角落和缝隙的吸尘。



**Round brush / 圆头刷**

- The head of the brush can rotate. For vacuuming fragile or easily scratched items.
- 刷子头部可以旋转, 用于脆弱或易破损之物的吸尘。



**Paper Bag Type**

- One paper bag setted in the vacuum cleaner and two extra paper bags provided.

**纸袋式**

- 吸尘器内装有一只纸袋, 此外还提供两只备用纸袋。

**Cloth Bag Type**

- One cloth bag setted in the vacuum cleaner.

**布袋式**

- 吸尘器内装有一只布袋。

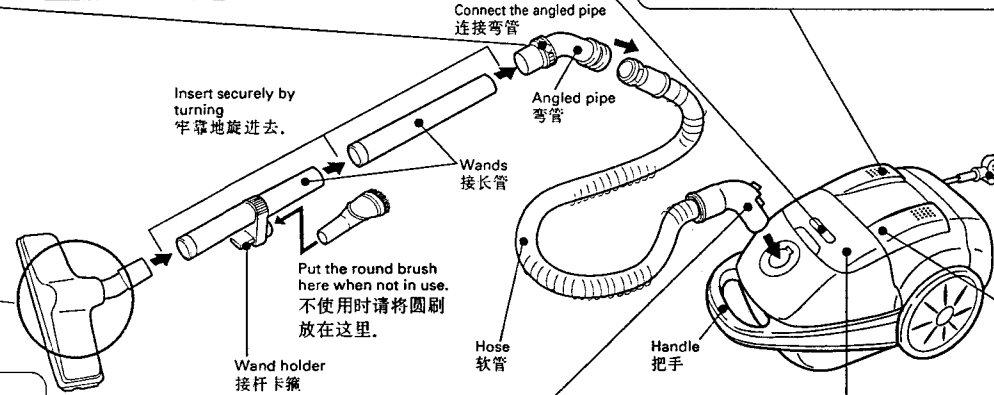

**Hose Stopper / 软管上推器**

- Insert the hose all the way up to the hose stopper. To detach it, press the hose stopper and pull the hose toward you.

- 请将软管尽力插到软管上推器。取下上推器时, 请按上推器, 并朝外拔出软管。

**Handy Attachment Compartment / 附件存仓**

- The compartment stores a crevice tool.
- 仓内存放有一个尖嘴头。

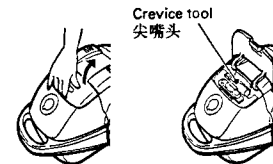

**Cord and Plug / 电源线和插头**

- Pull out the cord and connect the plug. Do not extend the cord from the unit beyond the red marker line.

- 拉出电源线, 然后连接插头。从本机中拉出电源线时, 勿使其超过红色标线。

**Foot Switch / 脚踏开关**

- Start or stop vacuum cleaner by pushing on the foot switch.

- 由踏下脚踏开关未启动或停止吸尘器。



# DUST DISPOSAL / 灰尘倒出

When the dust compartment is full, turn the motor off, pull the hose out of the vacuum cleaner and dispose of the paper dust bag as follows :

1. Open the dust compartment cover by pulling out the clamp button.

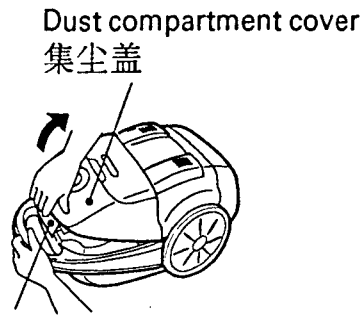

当集尘室装满灰尘时，关掉电动机，拉出吸尘器的软管并按下述处理纸袋：

1. 拉出锁夹钮来打开集尘盖。

2. Remove the filter frame .

Clamp button / 锁夹钮

2. 拆下滤尘框。

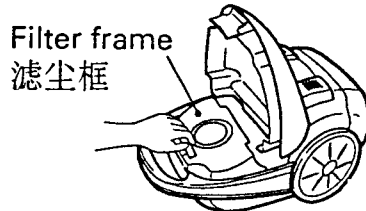

3. Remove the used bag from the filter frame and dispose of the bag.

3. 从滤尘框拆下用过的纸袋，将其丢掉。

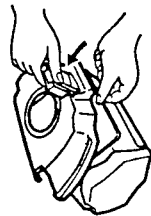

4. (Cloth Bag Type)  
Remove the holder for the cloth bag and empty the contents of the bag. Reinstall the holder exactly as it was before.



Remove by pulling in the direction of the arrow.  
按箭头方向拉出。

4. (布袋型)  
取下布袋夹口，腾空其中。重新装上夹口。  
(纸袋型)  
除去用过的纸袋。

(Paper Bag Type)  
Dispose the used paper bag.

5. 把新的纸袋装到滤尘框上。

5. Set a new bag in the filter frame.



6. 重新安置好滤尘框，关闭集尘盖。

6. Reattach the filter frame and close the dust compartment cover.

Groove / 槽

• Do not use the vacuum cleaner without a bag, it may damage a motor.  
• 请勿在没有装上纸袋的情况下使用吸尘器，否则可能会导致电动机损坏。

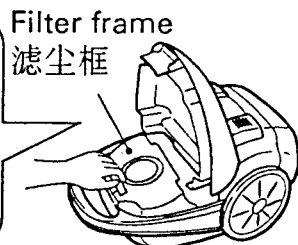

• As a safety feature, the dust compartment cover cannot close if the paper bag is not mounted correctly.  
• 作为一个安全功能，如果纸袋没有正确安装好，集尘盖就不能关闭。

## IMPORTANT (Paper Bag Type only) / 重要事项 (仅纸袋型)

- Use only genuine Sanyo paper bags to assure best results.
- Genuine Sanyo paper bags are available through your dealer. (Be sure to state the type number SC-P8A.)
- 请使用正宗的三洋纸袋，以确保最好的效果。
- 正宗的三洋纸袋可在销售店购买到。(购买时请说明型号为 SC-P8A)

# HOW TO USE THE HOSE STAND / 软管架的使用方法

- The vacuum cleaner with the floor nozzle, wands and hose can be stored while still connected.

- 真空吸尘器可在与吸尘嘴、接杆和软管连接着的情况下存放。

① Stand the vacuum cleaner up and insert the wand holder into the wand-holder hole.

② Hold the hose and wind it around the pipe.

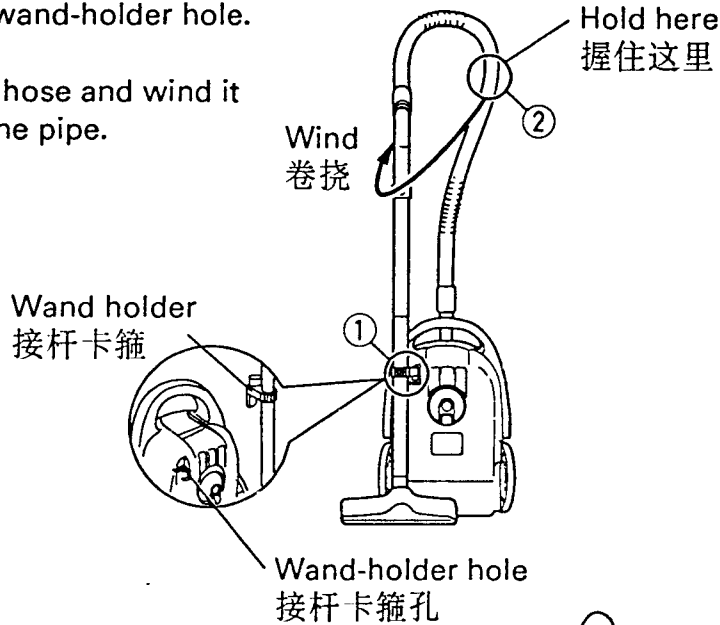

① 把真空吸尘器向上竖起，将接杆卡箍插入接杆卡箍孔。

② 握住软管将其卷绕在接杆上。

## Caution

Do not carry the vacuum cleaner while it is in the storage position.  
(Injury or damage may result if the hose or coupling pipe becomes unattached.)

## 注意：

在真空吸尘器处于存放位置时不要搬动它。  
(如果软管或联接管脱开，则会导致意外事故或损坏。)

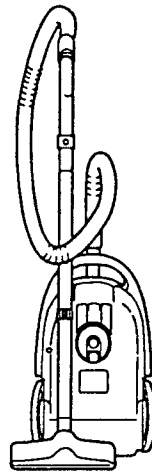

Thank you for your purchase of the Sanyo Vacuum Cleaner.  
Please read these instructions carefully before using.

## **A FEW PRECAUTIONS**

---

1. Operating without the filter in place will allow dust to enter the motor and could damage the vacuum cleaner.
2. Keep the vacuum cleaner away from stoves and other heat sources. Heat can deform and discolor the plastic parts of the unit.
3. Keep the vacuum cleaner free of insecticides. Do not wipe with benzine, thinner, petrol or other oils which might cause discoloration or cracking. To clean the body and hose, dampen a cloth with a mild detergent and wipe clean.
4. Blocking the suction inlet or allowing the dust to clog the hose will decrease the efficiency of the motor.
5. Never try to vacuum the following objects. They may damage the unit or cause a fire.
  - \* Wet things, mud, soil, and fluids
  - \* Burning cigarettes
  - \* Needles and razor blades
  - \* Inflammable materials such as gasoline and thinner
6. The following kinds of treatment shorten hose life:
  - \* Bending hose at an acute angle when storing
  - \* Pulling the hose with excessive force
  - \* Placing heavy objects on, or stepping on the hose
7. Pull out the plug from the power source after use. Grasp the plug – not the cord – when pulling out the plug.  
Pulling on the cord may lead to shortcircuiting.
8. Long and continuous use causes the exhaust air and the body of the vacuum cleaner to become warm. This, however, does not denote malfunction.
9. When vacuuming places that are very dusty, and also when vacuuming regularly, empty the dust compartment before it becomes completely filled.  
Frequent emptying lengthens the life of the motor and maintains strong suction power.
10. (For Special area only, Australia, New Zealand and Singapore)  
If the supply cord of this appliance is damaged, it must only be replaced by a repair shop appointed by the manufacturer, because special purpose tool are required.

## CARE OF FILTER / 清洗过滤网

- A severely soiled or clogged filter should be thoroughly washed with fresh tepid water. A neutral detergent could be used if required.

1. Washing 2. Drying



Cloth bag  
布袋

- 过滤网很脏或堵塞时，应该用新鲜的温热水进行彻底清洗。如有必要，请使用中性清洁剂。

1. 洗涤 2. 干燥

Cloth bag (Cloth Bag Type only)

布袋（仅布袋型）

Filter

过滤网

- Remove the filter and rinse it with water.

(Caution)

Never insert the cloth bag or filter into the vacuum cleaner unless it is completely dry.

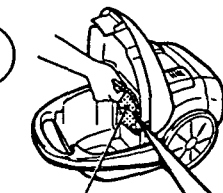

Filter  
过滤网

Be sure the bag is facing the right direction.



↓ 务必使袋口朝正确的方向。

- 取下过滤网，装水其中（注意）

布袋或过滤网未干完之前，绝对不得插入吸尘器中。

## CARE AND MAINTENANCE

If you have a problem with your vacuum cleaner, consult the handy guide below. If the vacuum cleaner is malfunctioning, do not operate it. Contact your dealer or the nearest Sanyo Service Center.

Problem	Possible cause	Possible solution
(1) Cleaner won't run.	1. Not firmly plugged in. 2. No voltage in wall outlet.	1. Plug unit in firmly. 2. Check fuse or breaker.
(2) Suction does not increase after cleaning out the dirt.	1. Filter dirty. 2. Clogged floor nozzle or hose.	1. Clean out the filter. 2. Clean out floor nozzle or hose.
(3) Cord doesn't fully rewind.	1. Cord twisted or uneven.	1. Pull out cord and rewind.

## 维护保养

如果你的吸尘器有问题，请查阅下表。如果吸尘器功能不正常，请不要使用它。此时，可求教你的销售店或就近的三洋维修服务中心。

问题	可能原因	解决办法
(1) 吸尘器不运转。	1. 电源插头未正确插好。 2. 墙上电源插座没有电。	1. 正确地插好电源插头。 2. 检查保险丝或断路器。
(2) 在清除灰尘后，吸力不增加。	1. 过滤网脏。 2. T型吸尘头或软管堵塞。	1. 清理过滤网。 2. 清理T型吸尘头或软管。
(3) 电源线不完全缩进。	1. 电源线扭曲或不直。	1. 拉出电源线，重新卷绕。

9BF-6-P1111-25041 0997-①  
E/CHI

**SANYO** 三洋

SANYO Electric Co., Ltd.  
OSAKA, JAPAN