

INSTRUCTION MANUAL

SANYO

SC 90 SERIES

VACUUM CLEANER

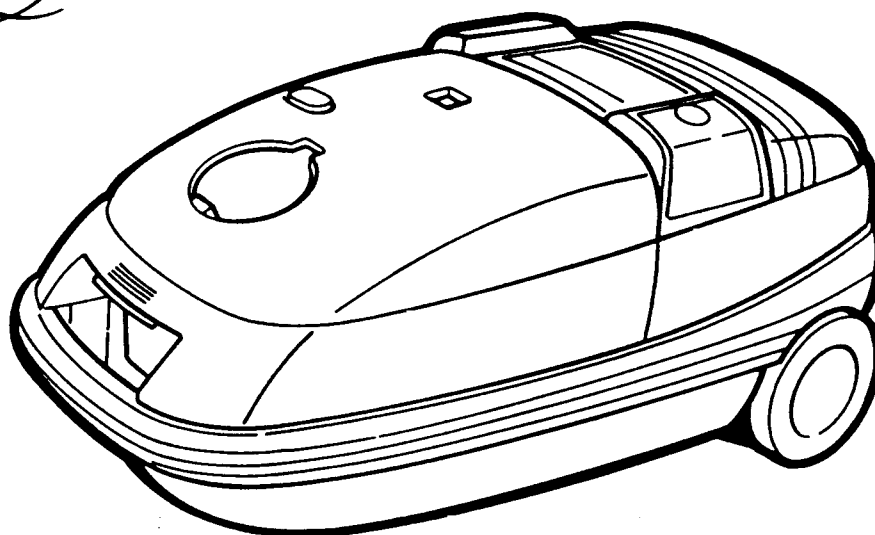

SPECIFICATIONS

MODEL NUMBER	POWER CONTROL	LED POWER LEVEL INDICATOR	MITE HUNTER	BEDDING TOOL	FRAGRANCE	FLOOR TOOL
SC T93	YES	YES	YES	YES	WITH INCENSE METAL & PERFUME BOTTLE	TURBINE BRUSH
SC 92	YES	—	—	—	CARTRIDGE ONLY	FLOOR NOZZLE
SC 92S	YES	—	—	—	CARTRIDGE ONLY	FLOOR NOZZLE
SC 91	SUCTION CONTROL	—	YES	YES	CARTRIDGE ONLY	FLOOR NOZZLE
SC 90	SUCTION CONTROL	—	—	—	CARTRIDGE ONLY	FLOOR NOZZLE

IMPORTANT SAFETY INSTRUCTIONS

When using an electrical appliance, basic precautions should always be followed, including the following:

**READ ALL INSTRUCTIONS
BEFORE USING THIS APPLIANCE**

WARNING

- To reduce the risk of fire, electric shock, or injury:
- Do not leave appliance when plugged in. Unplug from outlet when not in use and before servicing.
- Do not use outdoors or on wet surfaces.
- Do not allow to be used as a toy. Close attention is necessary when used by or near children.
- Use only as described in this manual. Use only manufacturer's recommended attachments.
- Do not use with damaged cord or plug. If appliance is not working as it should, has been dropped, damaged, left outdoors, or dropped into water, return it to a service center.
- Do not pull or carry by cord, use cord as a handle, close a door on cord, or pull cord around sharp edges or corners. Do not run appliance over cord. Keep cord away from heated surfaces.
- Do not unplug by pulling on cord. To unplug, grasp the plug, not the cord.
- Do not handle plug or appliance with wet hands.
- Do not put any object into openings. Do not use with any opening blocked; keep free of dust, lint, hair, and anything that may reduce air flow.
- Keep hair, loose clothing, fingers, and all parts of body away from openings and moving parts.
- Do not pick up anything that is burning or smoking, such as cigarettes, matches, or hot ashes.
- Do not use without paper bag/or filters in place.
- Turn off all controls before unplugging.
- Use extra care when cleaning on stairs.
- Do not use to pick up flammable or combustible liquids such as gasoline or use in areas where they may be present.
- **Unplug before connecting any hose attachment accessory.**
- Hold plug when rewinding onto cord reel. Do not allow plug to whip when rewinding.
- Avoid using in a vertical position.

SAVE THESE INSTRUCTIONS

CAUTION (For Special area only)

If the supply cord of this appliance is damaged, it must only be replaced by a repair shop appointed by the manufacturer, because a special purpose tool is required.

NAME OF PARTS (Assemble as indicated in the center illustration.)

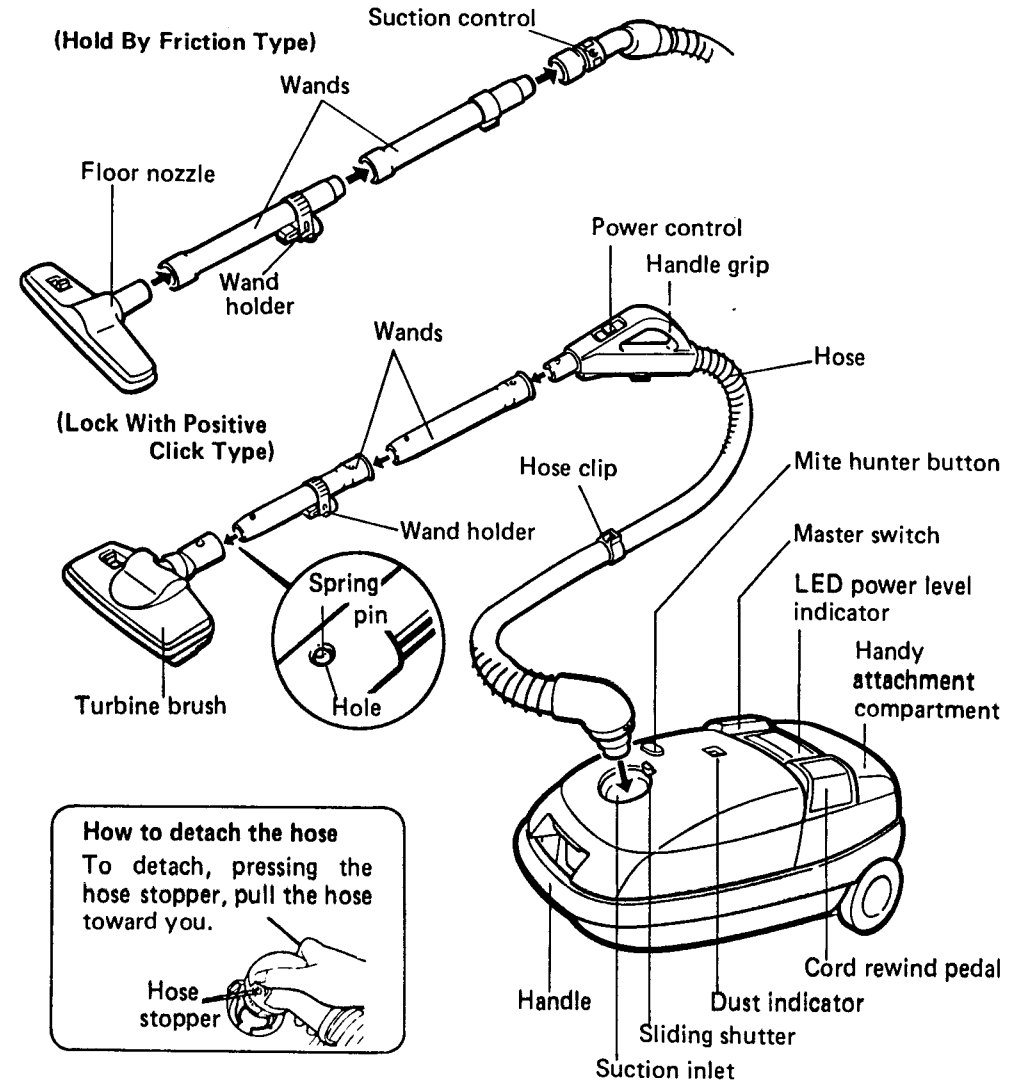

OTHER ATTACHMENTS

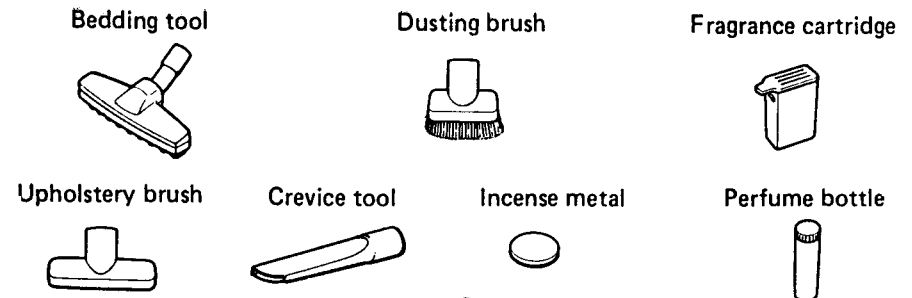

OPERATION

1. Cord

Pull out the cord and plug it in the power outlet.

(Caution)

Do not pull out the cord from the vacuum cleaner beyond the red marker line.

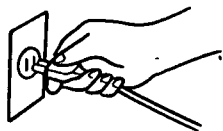

Rewinding

To retract the cord back into the vacuum cleaner, press the cord rewind pedal.

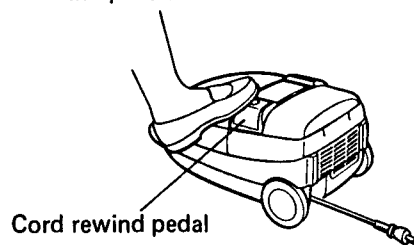

2. Switch

(Power Control Type)

To start cleaner, first turn on the master switch, then turn on the power control.

To stop cleaner momentarily, turn off power control. When vacuuming is finished, turn off power control and the master switch.

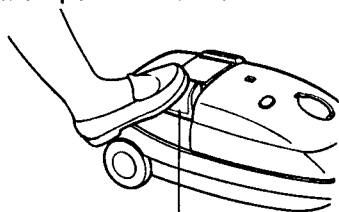

Master switch

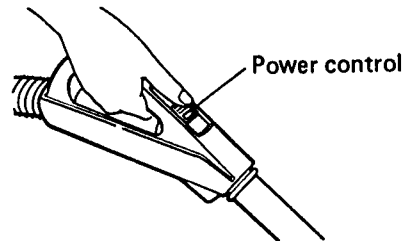

Power control

(Master Switch Only Type)

Step on master switch for starting or stopping the vacuum cleaner.

3. Power control

Adjust power control to "MAX"; suction power becomes maximum.

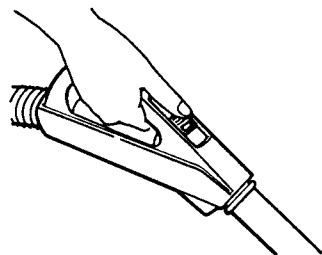

3. Suction control

Suction power gets weak when opened. Normally use in closed condition.

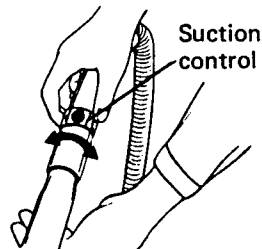

Suction control

4. LED Power level indicator

LED lights to indicate the suction power level.

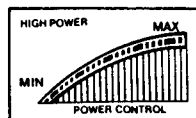

OPERATION

5. Turbine brush

The two-way turbine brush has a lever with two positions.

(Caution)

Do not clean bare floors with lever position "RUG".

This might damage the floor.

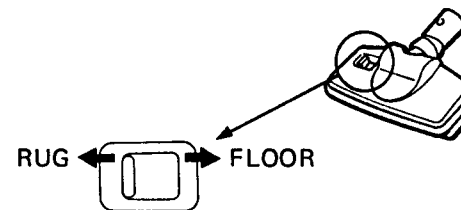

5. Floor nozzle

The two-way floor nozzle has a lever with two positions.

FLOOR: For vacuuming wooden floors, linoleum or plastic covered floors.

RUG: For vacuuming rugs and carpets.

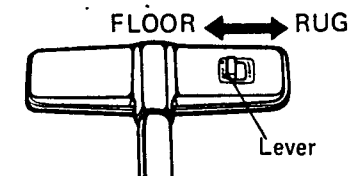

6. Dust indicator

The dust indicator shows when the paper bag or cloth bag is full. When the dust indicator has turned from green to red, empty the bag.

(When checking the dust)

- Set the power control to "MAX".
- Close the suction control.
- Lift the turbine brush or floor nozzle off the floor.
- Remove the crevice tool.

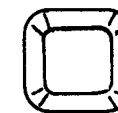





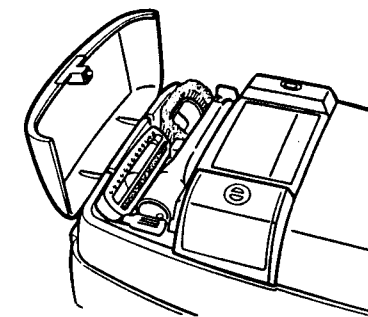
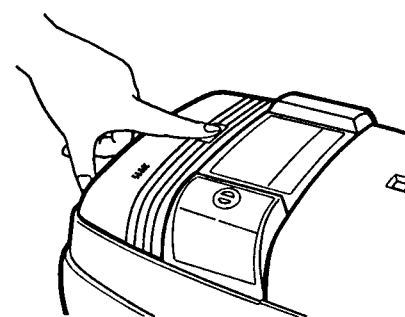

DUST INDICATOR

7. Handy attachment compartment

The compartment stores a dusting brush, upholstery brush, crevice tool and fragrance cartridge, a quick selection for all your cleaning needs. Depress the "PUSH" mark to open the tool cover.



ATTACHMENT USE

ATTACHMENT	CLEANING AREA									
	Furniture	Drapes	Stairs	Bare floors	Carpeted floors	Blanket	Between cushions	Rugs	Walls	
Bedding tool 						X				
Dusting brush 	X	X	X				X		X	
Upholstery brush 	X	X	X				X		X	
Crevice tool 	X		X	X	X		X			
Floor nozzle 				X	X			X		
Turbine brush 				X	X			X		

THERMAL SAFETY DEVICE

Built in thermal safety device protects the cleaner motor from overheating. If the cleaner hose or air intake clogs up with dust, or if the paper bag or cloth bag becomes full and continues to run the cleaner, the cleaner will shut off automatically to prevent the motor from overheating. If this happens, disconnect the plug from power outlet, remove the clogged material or change paper bag or empty cloth bag and let the cleaner cool down. Approximately one hour after, you can restart your cleaner. If the cleaner will not start, please consult a Sanyo Service Center.

HOW TO ENJOY FRAGRANCE

If you prefer a fragrance while cleaning, follow the steps below.

1. Push the "PUSH" mark to open the tool cover.
2. Pull out the fragrance cartridge.

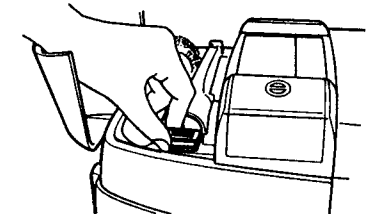
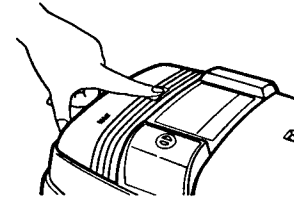

(With Incense Metal And Perfume Bottle Type)

3. Take out the incense metal and perfume bottle. Then twist the cap of the perfume bottle and pull to open.

Pour two or three drops of perfume on the incense metal and allow them to soak in. After that insert them back in the fragrance cartridge.

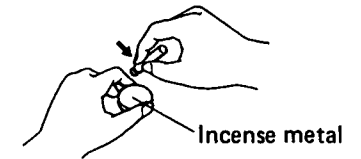
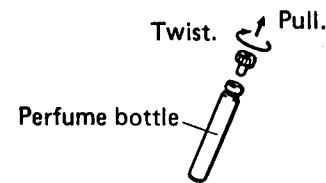

(Cartridge Only Type)

3. Please purchase fragrance pellets at the outlet and insert into the fragrance cartridge.

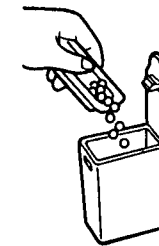

4. Close the cover.

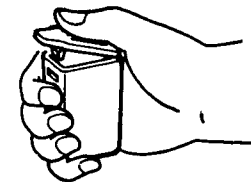

5. Insert the fragrance cartridge into the handy attachment compartment and close the cover.

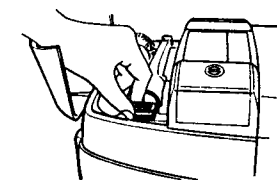

HOW TO USE THE "Mite Hunter"

• Construction and Method of Extermination

The "Mite Hunter" exterminates mites in two steps. First, mites are vacuumed into a disposable paper bag or cloth bag. Then they are exterminated inside the filter at temperatures of 50°C or higher by exhaust fumes circulated from the motor. (Mites cannot survive at temperatures above approx. 50°C)

• Operation

1. Shut the sliding shutter.

If "Mite Hunter" button was pushed before you shut the sliding shutter, "Mite Hunter" function will start automatically when you shut the sliding shutter.

Sliding shutter

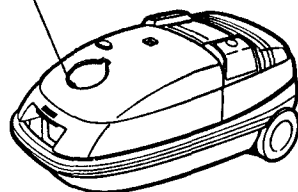

2. Push the "Mite Hunter" button.

Start "Mite Hunter" operation.

Mite hunter button

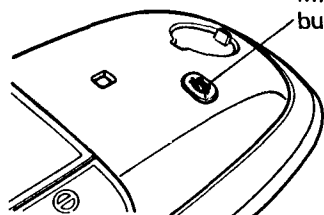

Light the Mite sign.

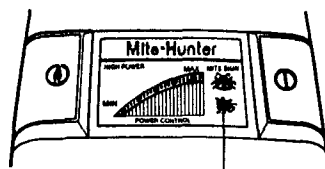

Mite sign

3. "Mite Hunter" operation.

The motor will circulate the hot exhaust fumes inside the filter approx. 2 to 8 minutes, and then automatically turn off.

(Caution)

- The "Mite Hunter" may become slightly hot during operation, and the dust indicator may turn red. This occurs with normal use and is not a cause for concern.
- If ambient temperature is high, immediate after operation of cleaner, "Mite Hunter" may not function. In this case, try it again after 30 minutes.

DUST DISPOSAL

Turn the motor off, pull the hose out of the vacuum cleaner and empty out the dirt as follows:

1. Open the dust compartment cover by pulling out the clamp button.

Dust compartment cover

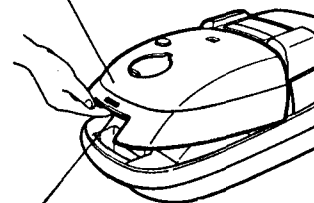

Clamp button

2. Take out the filter frame.

Filter frame

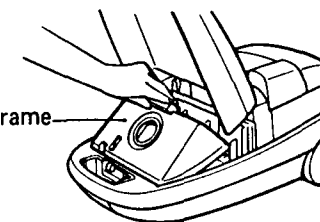

(Cloth Bag Type)

3. Remove the cloth bag from the filter frame and open the fastener of the cloth bag, then empty out the dirt.

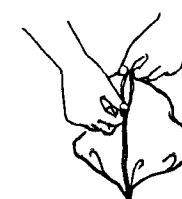

4. Close the fastener of the cloth bag and set the cloth bag to the filter frame.

Hook
Groove

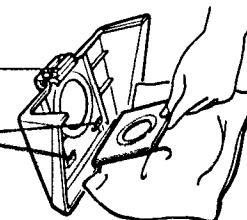

(Paper Bag Type)

3. Remove the paper bag from the filter frame and dispose the used paper bag.

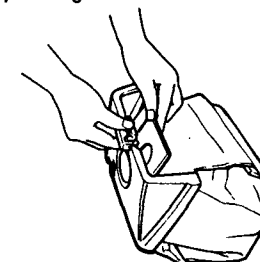

4. Set the new paper bag to the filter frame.

Hook
Groove

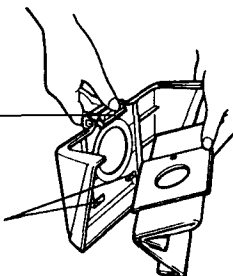

(Caution)

Unless the paper bag or cloth bag is correctly mounted, dust compartment cover will not close for safe use.

HOW TO USE THE HOSE STAND

The vacuum cleaner with the turbine brush or floor nozzle, wands, and hose can be stored while still connected.

1. Insert the wand holder into the hole of the vacuum cleaner.

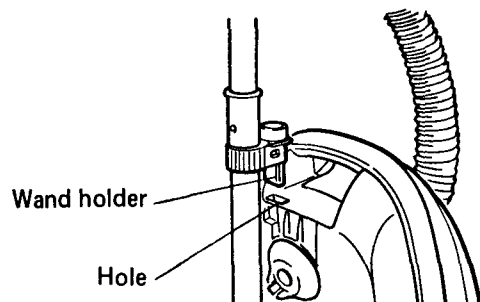

2. Attach the hose clip to the hose clip holder.

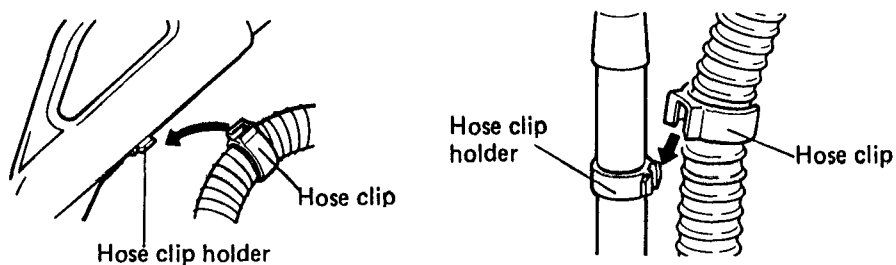

3. Insert the pipe of the bedding tool to the convex of the wand holder.

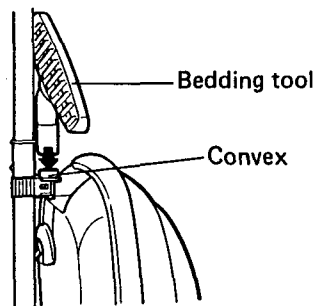

(Caution)

Do not move or carry the vacuum cleaner while it is in the storage position, as the hose or wands may fall out and become damaged.

CARE OF FILTER

A severely soiled or clogged filter should be thoroughly washed with fresh tepid water. A neutral detergent could be used if required.

1. Washing
2. Drying

Cloth bag (Cloth Bag Type Only)



Filter

Remove the filter and rinse it with water.

(Caution)

Never insert the cloth bag or filter into the vacuum cleaner unless it is completely dry.

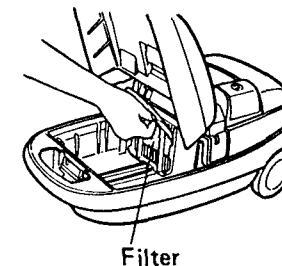

CARE OF TURBINE BRUSH

Before caring for the turbine brush, be sure to turn OFF the switch of the unit and disconnect the plug from the outlet.

If needles, pins or waste paper get stuck in the suction inlet, remove them after going through the above procedure.

Trying to remove them during operation is dangerous.

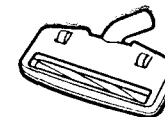

IMPORTANT (Paper Bag Type Only)

- Use only genuine Sanyo paper bags to assure best results.
- Genuine Sanyo bags are available through your dealer.
(Be sure to state the type number SC-P8)

CARE AND MAINTENANCE

If you have a problem with your vacuum cleaner, consult the handy guide below. If the vacuum cleaner is malfunctioning, do not operate it. Contact your dealer or the nearest Sanyo Service Center.

Problem	Possible cause	Possible solution
(1) Cleaner won't run.	<ol style="list-style-type: none">1. Not firmly plugged in.2. No voltage in wall outlet.3. Thermal safety device operated.	<ol style="list-style-type: none">1. Plug unit in firmly.2. Check fuse or breaker.3. Refer to page 5 "Thermal safety device". Approximately one hour later, you can restart the cleaner.
(2) The dust indicator moves immediately to the red zone.	<ol style="list-style-type: none">1. Paper bag or cloth bag full.2. Filter dirty.	<ol style="list-style-type: none">1. Change throw away paper bag or cleaning cloth bag.2. Clean out the filter.
(3) Cord doesn't fully rewind.	<ol style="list-style-type: none">1. Cord twisted or uneven.	<ol style="list-style-type: none">1. Pull out cord and rewind.

The Sanyo logo consists of the word "SANYO" in a bold, sans-serif font. The letter "A" is stylized with several vertical lines of varying heights passing through it, creating a distinctive graphic element.

SANYO Electric Co., Ltd.
OSAKA, JAPAN