

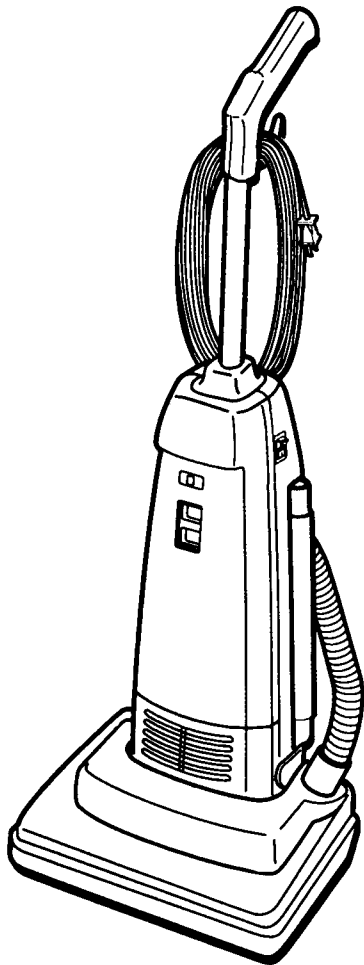

INSTRUCTION MANUAL
VACUUM CLEANER

SC-U8 MA



Contents

IMPORTANT SAFETY INSTRUCTIONS.....1
NAMES OF EACH PART.....3
PREPARATION BEFORE EACH USE.....4
USING THE VACUUM CLEANER.....5
USING THE ATTACHMENTS.....6
REPLACING THE PAPER BAG.....7
CLEANING AND REPLACING THE
SECONDARY FILTERS.....8
CLEARING BLOCKAGES IN THE
SUCTION HOSE AND CLEANING THE
AGITATOR ASSEMBLY.....9
REPLACING THE BELT.....10
TROUBLESHOOTING.....11

IMPORTANT SAFETY INSTRUCTIONS

When using an electrical appliance, basic precautions should always be followed, including the following.

READ ALL INSTRUCTIONS BEFORE USING THE VACUUM CLEANER

WARNING - To reduce the risk of fire, electric shock or injury:

1. Do not leave the vacuum cleaner when plugged in. Unplug it from the outlet when not in use and before servicing.
2. Do not use outdoors or on wet surfaces.
3. Do not allow it to be used as a toy. Close attention is necessary when used by or near children.
4. Use only as described in this manual. Use only the manufacturer's recommended attachments.
5. Do not use with a damage cord or plug. If the vacuum cleaner is not working as it should, or if it has been dropped, damaged, left outdoors or dropped into water, return it to a service center.
6. Do not pull or carry by the cord, use the cord as a handle, close a door on the cord, or pull the cord around sharp edges or corners. Do not run the vacuum cleaner over the cord. Keep the cord away from heated surfaces.
7. Do not unplug by pulling on the cord. To unplug, grasp the plug, not the cord.
8. Do not handle the plug or the vacuum cleaner with wet hands.
9. Do not put any objects into the openings. Do not use with any opening blocked: keep free of dust, lint, hair and anything that may reduce air flow.
10. Keep hair, loose clothing, fingers and all the parts of your body away from openings and moving parts.
11. Do not pick up anything that is burning or smoking, such as cigarettes, matches or hot ashes.
12. Do not use without paper bag and/ or filters in place.
13. Turn off all controls before unplugging.
14. Use extra care when cleaning on stairs.
15. Do not use to pick up flammable or combustible liquids such as gasoline, or use in areas where they may be present.

16. Do not touch the agitator while it is spinning.
17. Do not place any heavy items on top of the vacuum cleaner.
18. Do not step on the hose or pull it too strongly.
19. Do not pick up items such as pieces of waste paper or cloth which look as though they may cause the hose to become blocked.
20. Do not clean or store the vacuum cleaner in places where there are high temperatures.
21. Store the vacuum cleaner away from excessive humidity.
22. When carrying the vacuum cleaner, hold it by the carrying handle.
23. Before servicing the vacuum cleaner, allow all metal parts to cool first.
24. Always depress the foot pedal release when adjusting the handle position of the vacuum cleaner.
25. (For Australia only)
If the supply cord of this appliance is damaged, it must only be replaced by a repair shop appointed by the manufacturer, because special purpose tools are required.

SAVE THESE INSTRUCTIONS

This vacuum cleaner is intended for household use only.

NAMES OF EACH PART

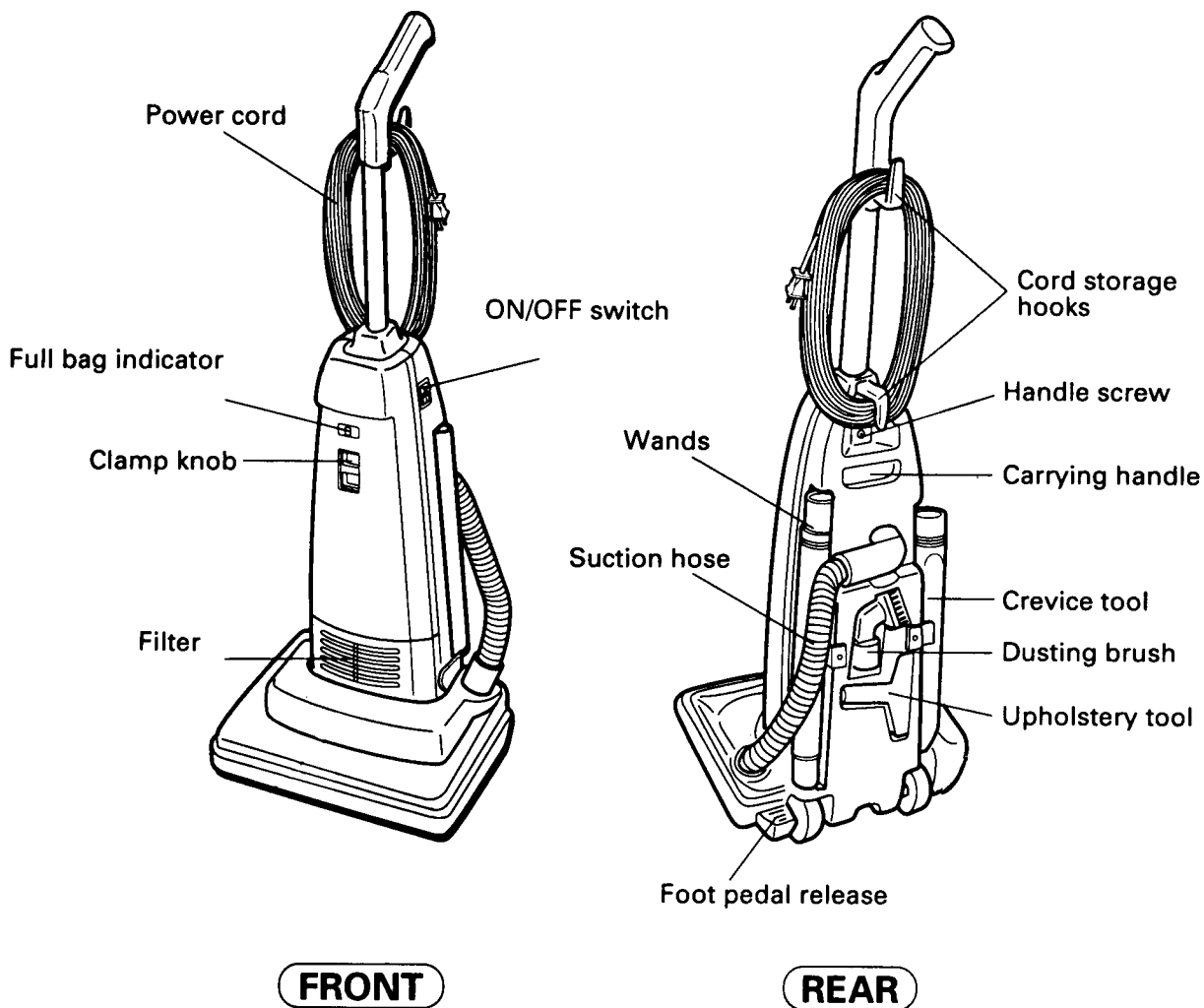

WARNING:

Operate vacuum cleaner only at the voltage specified on nameplate.

PREPARATIONS BEFORE USE

Caution: Do not connect the power plug to the wall socket until assembly is completed.

ATTACHING THE HANDLE TO THE VACUUM CLEANER

- 1** Insert the handle as far as it will go into the hole at the top of the vacuum cleaner.

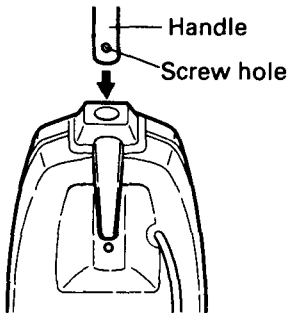

- 2** Locate the handle screw, and remove the tape covering the screw. Align the screw hole in the handle with the screw hole in the vacuum cleaner body, and insert the handle screw and tighten it as far as it will go.

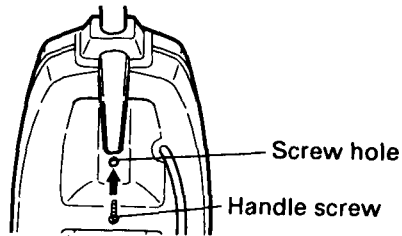

WINDING THE POWER CORD

- 1** Hook the power cord over the clip which is located on the upper cord storage hook as shown.

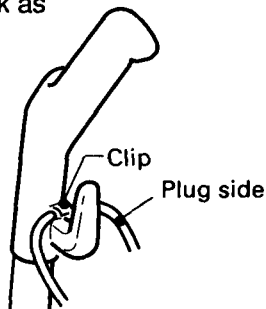

- 2** Wind the power cord around the cord storage hooks.

*Plug shown in figure may differ from actual plug attached to unit for your area.

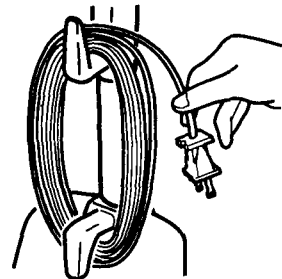

RELEASING THE POWER CORD

- 1** Rotate the upper cord storage hook downward.

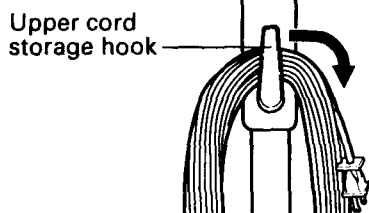

- 2** Return the hook to the upright position before attempting to rewind the power cord.

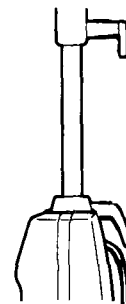

USING THE VACUUM CLEANER

ON/OFF SWITCH

- 1 Set the ON/OFF switch to "1" (ON) to operate the vacuum cleaner.
- 2 Set the ON/OFF switch to "0" (OFF) to stop the vacuum cleaner.

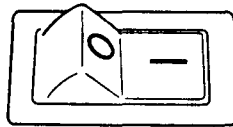

FULL BAG INDICATOR

Checking the full bag indicator as a guide for when to replace the paper bag.

- If the full bag indicator displays a red color when the vacuum cleaner is operating and the main unit is lifted off the floor, this indicates that it is time to replace the paper bag.
- The full bag indicator may also display a red color when the crevice tool is being used, however this does not indicate abnormality.

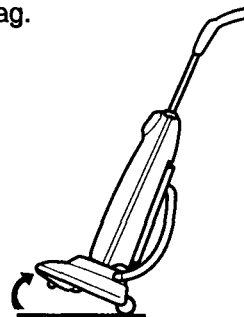

Caution

- If a lot of rubbish such as lint has been picked up, the full bag indicator may not display red even though the paper bag has become full.
 - If a lot of sand and dirt has been picked up, the full bag indicator may display red even though the paper bag has not yet become full.
- In both the above cases, replace the paper bag.

ADJUSTING THE HANDLE

The handle of this vacuum cleaner can be set to one of three positions - Upright, Normal or Parallel. To release the handle, depress the pedal at the left rear corner of the vacuum cleaner.

Upright position

The handle is normally locked in this position for storage or when using the attachments. Push the handle forward until it locks.

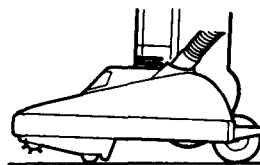
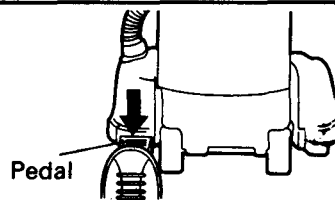

Normal Position

This position is used for normal cleaning.

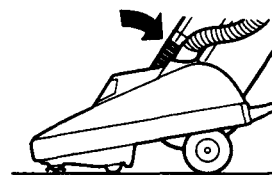

Parallel position

This position is used for cleaning under furniture. To set to Parallel position, depress the pedal at the left rear corner of the vacuum cleaner again.

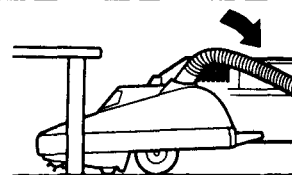

EDGE CLEANING

This vacuum cleaner is equipped with an "edge cleaning" function for cleaning carpet edges near baseboards and stationary furniture.

USING THE ATTACHMENTS

Caution: When using one of the attachments during cleaning, set the vacuum cleaner to the upright position.

1 Disconnect the hose from the vacuum cleaner.

- Pull the hose gently in the direction of the arrow to disconnect it.

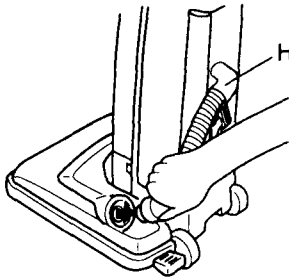

2 Remove the wand and crevice tool from the vacuum cleaner.

- The wand contains another wand in it. Pull out the second wand.

Caution: When removing the wand and crevice tool, pull them in the directions shown in the illustration below. Pulling them toward the back of the vacuum cleaner or pulling them forcefully may cause damage to the attachment ribs.

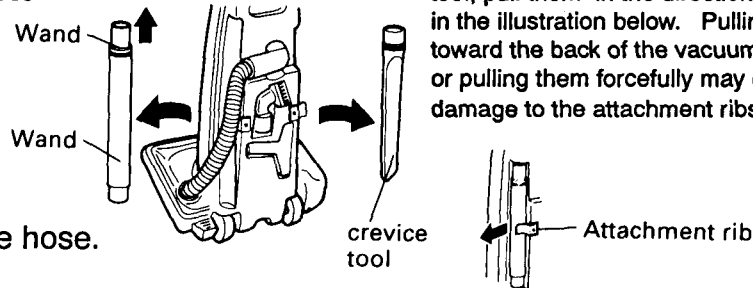

3 Install the wand to the hose.

- To achieve maximum reach with attachments, attach the crevice tool to the end of the wand.
- Securely and firmly connect the wand to the hose while twisting the wand, as shown in the illustration below.
- The end of the wand which has the marking of  should be connected to the hose.
- The dusting brush and the upholstery tool can be attached directly to the wand, hose or the end of the crevice tool. Refer to the illustration for the correct way to position the dusting brush and the upholstery tool.

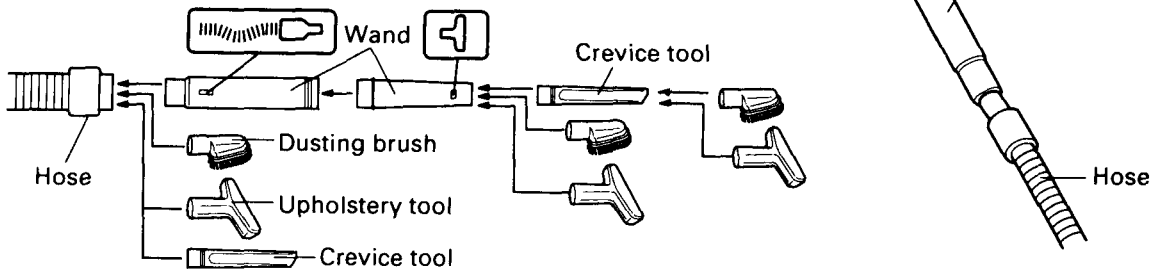

STORING THE ATTACHMENTS

When you have finished using the vacuum cleaner, replace the attachments in their original positions.

- Place one wand back into the other, as shown in the illustration to the right.
- Replace the wands and crevice tool aligning the markings on the attachments with the markings of the main unit.
- Firmly insert the hose into the main unit of the vacuum cleaner aligning the markings (.) on both.

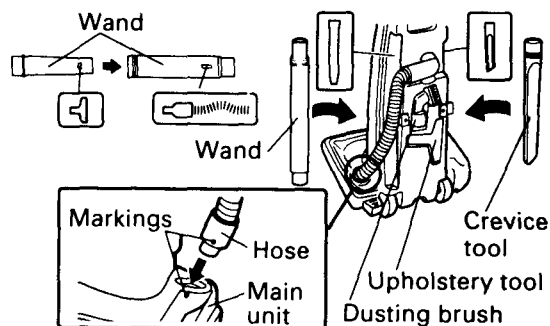

REPLACING THE PAPER BAG

Caution: Be sure to turn the ON/OFF switch to the OFF position and disconnect the power cord from the wall outlet when replacing the paper bag.
Always make sure the paper bag is installed properly before using.

- 1** Press the clamp knob which is on top of the dust cover, and then pull the dust cover forward to remove it.

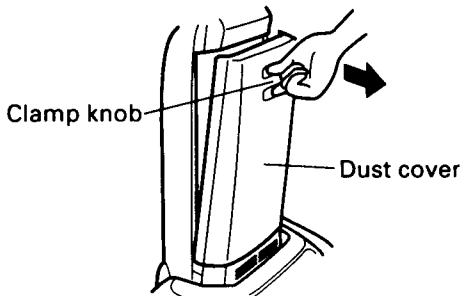

- 2** Hold the collar of the paper bag and carefully pull it forward to remove the paper bag.

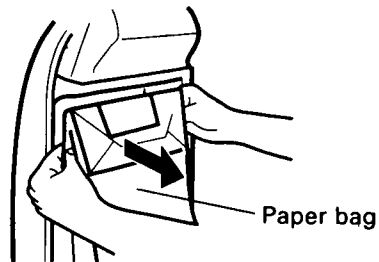

- 3** Place the vacuum cleaner in the parallel position. Unfold a new paper bag, and insert it by pressing the hole in the paper bag collar completely around the suction inlet.

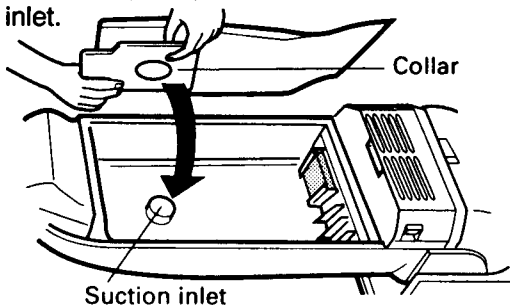

- 4** Spread out the sides of the new bag, and then place the bottom edge of the paper bag under the rib of the bag compartment.

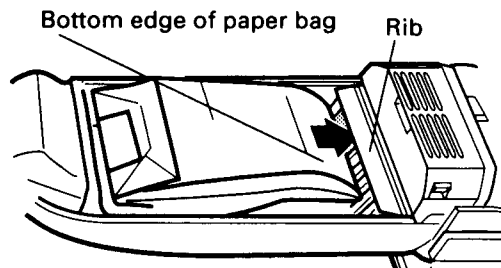

- 5** Return the dust cover to its original position.

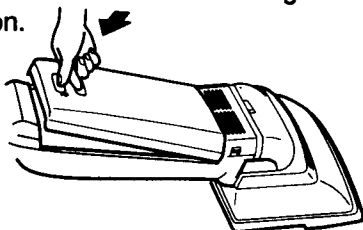

Caution: If the bottom edge of the paper bag is not placed under the rib, the dust cover may not close properly or suction performance may suffer.

Caution: Be careful not to clamp the paper bag with the edge of the dust cover.

Obtaining new paper bags

- You can obtain paper bags from your nearest Sanyo dealer.
- Be sure to specify only Sanyo vacuum cleaner bags. If bags from any other manufacturer are used, it may have adverse effects on vacuum cleaner performance.

SC-PU1

CLEANING AND REPLACING THE SECONDARY FILTERS

Caution: Be sure to turn ON/OFF switch to the OFF position and disconnect the power cord from the wall outlet before cleaning and replacing the filters.

CLEANING THE FILTER

1 Depress the foot pedal release and set the handle to the parallel position.

2 Remove the filter cover.
Grasp the filter cover with a hand on each side, press inward and pull the filter cover away from the vacuum cleaner.

3 After washing the filter in water and leaving the filter in a shady place to dry for about one day, make sure that it is completely dry and then re-install it into the vacuum cleaner.

4 Replace the filter cover.

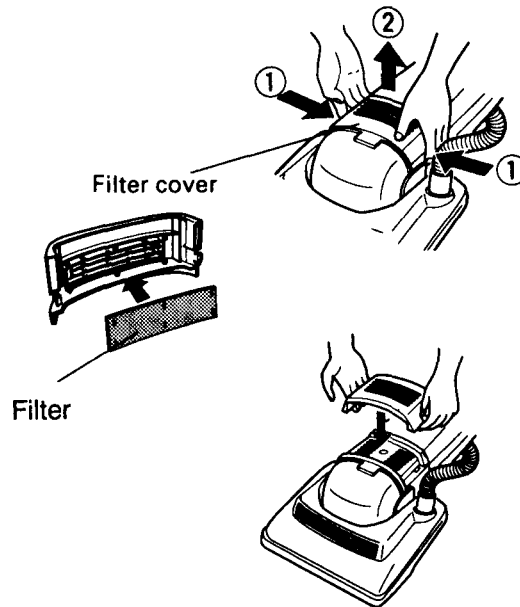

CLEANING THE SUB-FILTER

Clean the sub-filter when it becomes dirty.

1 Remove the dust cover.
Remove the paper bag.

2 Remove the sub-filter from the vacuum cleaner.

3 Gently clean the sub-filter with water.

4 After leaving the sub-filter in a shady place to dry for about one day, make sure that it is completely dry and re-install it into the vacuum cleaner. Replace the paper bag.

Caution: Do not wash the sub-filter in a washing machine, and do not use any other equipment such as hair dryer to dry it. Do not operate the cleaner without the sub-filter. Be sure the filter is dry and properly installed. Failure to do so could result in electrical shock, personal injury, or motor failure.

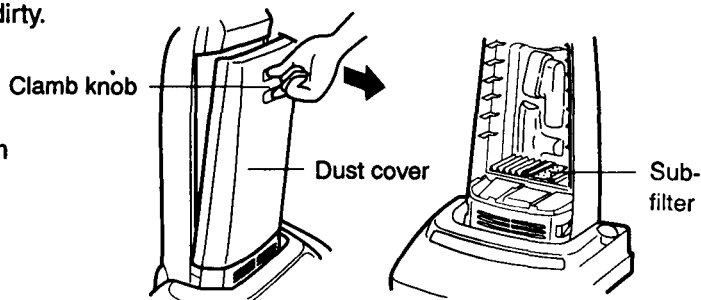

CLEARING BLOCKAGES IN THE SUCTION HOSE AND CLEANING THE AGITATOR ASSEMBLY

Caution: Be sure to turn the ON/OFF switch to the OFF position and disconnect the power cord from the wall outlet before clearing the blockages in the suction hose and cleaning the agitator assembly.

Clearing blockages in the suction hose

- 1** Set the vacuum cleaner to the upright position.
- 2** Twist the hose cuff and pull it away from the vacuum cleaner to remove it from the suction inlet, and then remove the blockage.
- 3** Reattach the hose cuff to the suction inlet, and then operate the vacuum cleaner to check that the blockage has been properly cleared. If the hose is still blocked, the suction force will be weak.

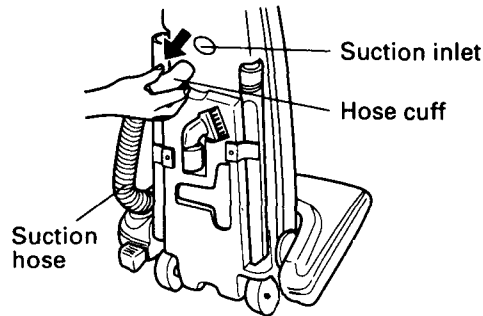

If the hose still appears to be blocked

- 1** Set the vacuum cleaner to the parallel position and turn it over.
- 2** Twist the hose cuff and pull it away from the vacuum cleaner to remove it from the suction inlet.
- 3** Remove the bottom plate (refer to page 10). Disconnect the suction hose from the nozzle pipe.
- 4** Remove any blockages in the hose and the nozzle pipe, while being extremely careful not to damage the hose or the nozzle pipe.
- 5** Re-install all the parts in the reverse order of removal. (For the procedure for reattaching the bottom plate, refer to page 10).

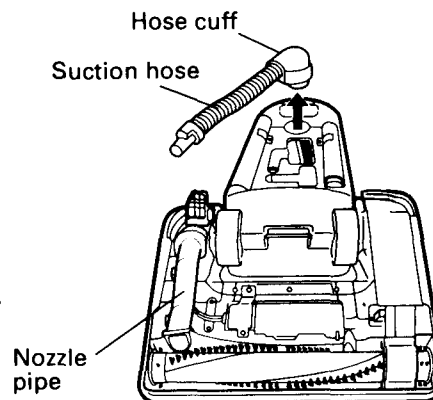

Caution:

- Check that all parts have been installed correctly before reattaching the bottom plate.
- Firmly and securely insert the hose cuff.

Cleaning the agitator assembly

When threads get caught in the agitator assembly, clean the assembly.

- 1** Remove threads caught in the assembly by cutting them with scissors.

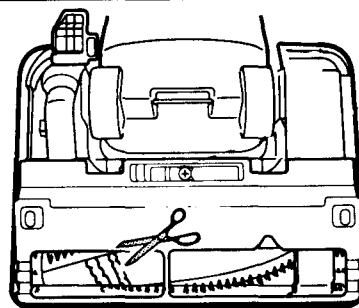

REPLACING THE BELT

Caution: Be sure to turn the ON/OFF switch to the OFF position and disconnect the power cord from the wall outlet before replacing.

1 Set the vacuum cleaner to the parallel position.

2 Turn the vacuum cleaner over.

3 Loosen the mounting screw, and then remove the bottom plate.

4 Lift up the belt cover and then remove the pulley cover.

5 Lift out the agitator assembly, and then remove the flat belt from the motor shaft and the agitator pulley.

6 Place a new belt onto the motor shaft and onto pulley A.

7 Place the agitator into the grooves in the nozzle head, making sure that the new belt slides securely into the guide.

Caution: Install the belt so that it has no twists in it, and so that all components turn smoothly.

8 Replace the pulley cover, lower the belt cover, and check that all parts have been installed correctly before reattaching the bottom plate.

9 Install the bottom plate so that the tabs fit into the grooves at the front end of the nozzle head.

• Tighten the mounting screw.

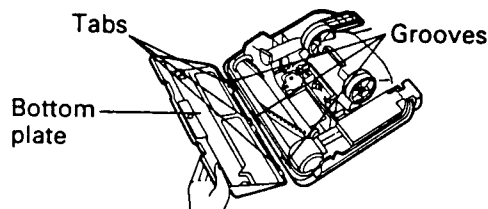
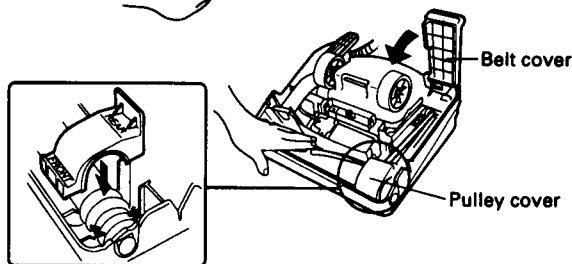
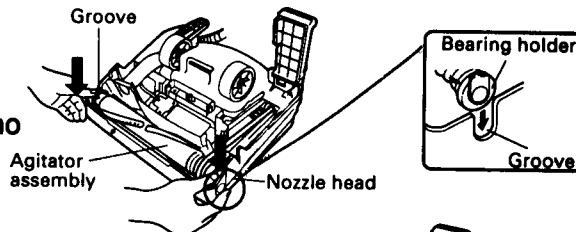
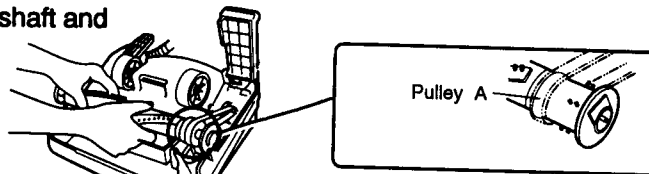
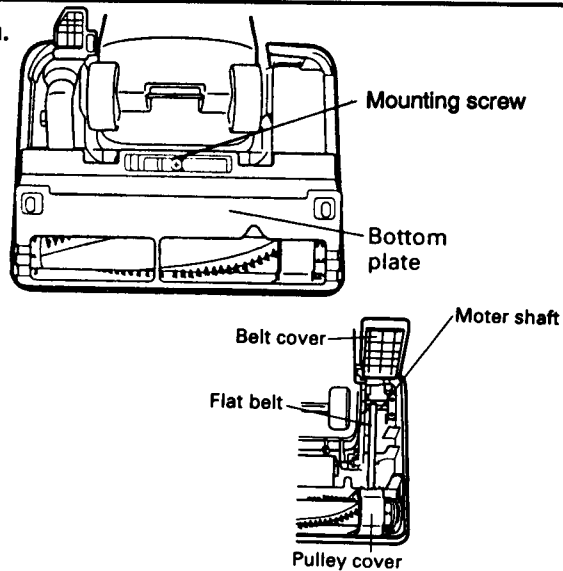

TROUBLESHOOTING

- If there is a problem with the vacuum cleaner, carry out the following checks to find the cause. If the problem still persists after the checks have been made, do not use the vacuum cleaner to prevent the possibility of an accident occurring. Turn the ON/OFF switch to the OFF position, disconnect the power cord from the wall outlet, and contact the place of purchase or your nearest Sanyo service center.

Problem	Cause	Remedy
The motor does not operate when the ON/OFF switch is set to the ON position.	<ul style="list-style-type: none"> ● The power cord plug is not securely inserted into the wall socket. 	<ul style="list-style-type: none"> ● Insert the power cord plug securely into the wall socket.
Suction force is weak.	<ul style="list-style-type: none"> ● The full bag indicator displays a red color. ● The power head or suction hose is blocked. ● The secondary filters are dirty. 	<ul style="list-style-type: none"> ● Replace the paper bag. ● Remove the blockage. ● Clean the secondary filters.
The agitator does not operate.	<ul style="list-style-type: none"> ● The flat belt is worn or broken. 	<ul style="list-style-type: none"> ● Replace the flat belt

9BF - 6 - PIII - 20522

SANYO

SANYO Electric Co., Ltd.
OSAKA. JAPAN