

INSTRUCTION MANUAL
使用说明书

SANYO 三洋

SC-X1500/2100A

VACUUM CLEANER

吸尘器

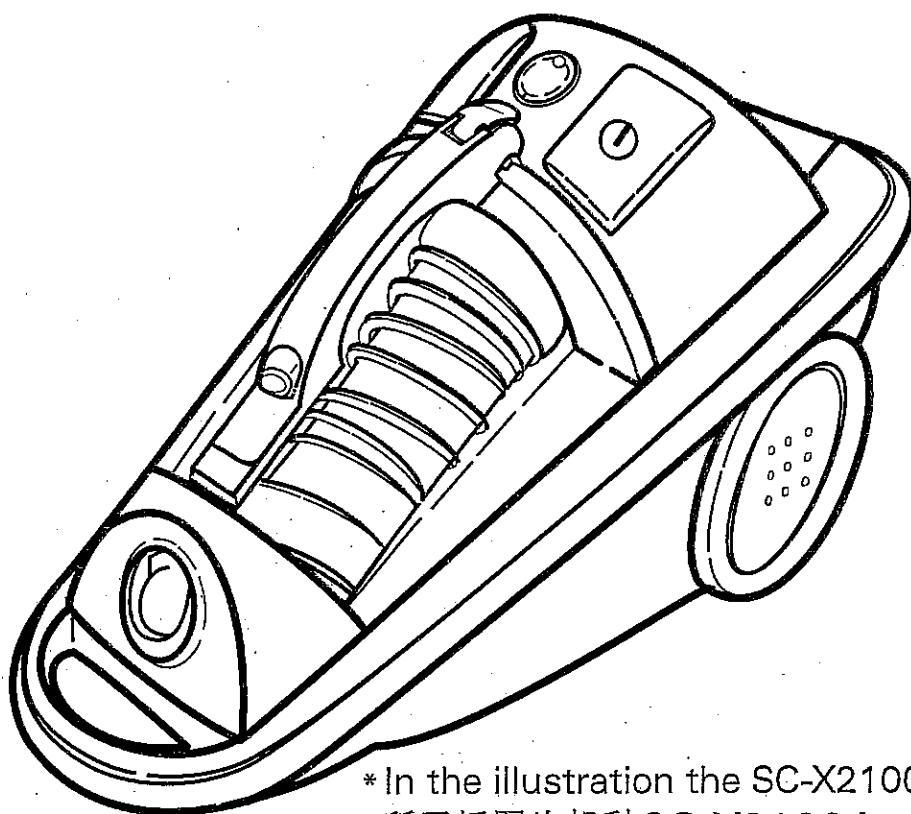

* In the illustration the SC-X2100A is shown

* 所示插图为机种SC-X2100A

SPECIFICATION

规格

Model 型号	Power Control 功率控制
SC-X2100A	○
SC-X1500	—

HOUSEHOLD USE ONLY

仅供家庭使用

○ --- With power control/ 有功率控制

— --- Without power control/ 无功率控制

EMPTYING THE DUST COMPARTMENT / 灰尘倒出

Caution: Be sure to turn the ON/OFF switch to the "OFF" position and disconnect the power cord from the wall outlet before cleaning.

1. Empty the dust compartment when contents reach the MAX mark.

1. 当垃圾至MAX（充满）标记时，请倒空储尘室。

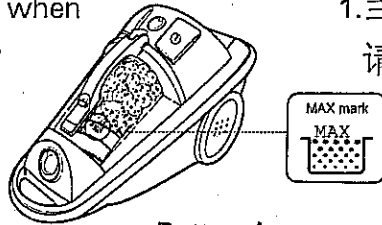

2. Release button A, then press button B to remove the dust compartment.

2. 按下储尘室锁紧扣，取下储尘室。

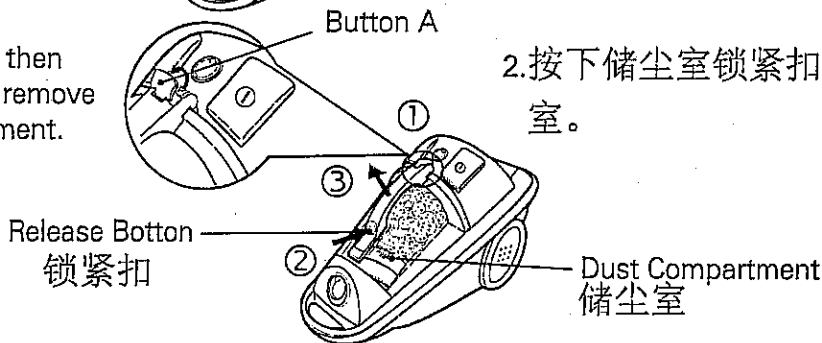

3. Press the release lever to open the trapdoor.

3. 按下储尘室锁紧杆，打开储尘室盖。

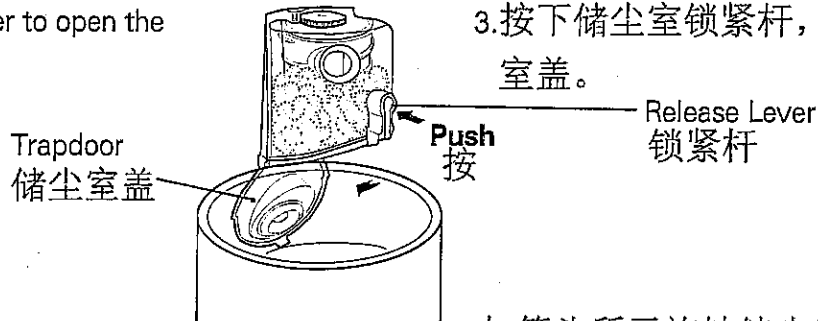

4. Turn the duster handle several times in the direction shown to empty the dust compartment.

4. 如箭头所示旋转储尘室旋钮数次，倒出储尘室内垃圾。

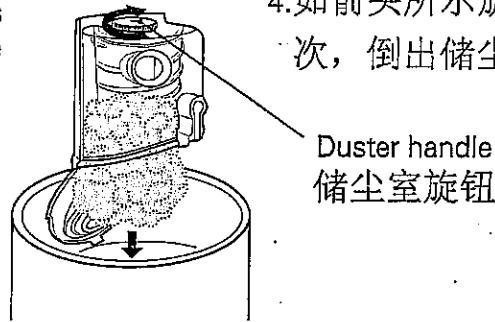

Reattaching the Dust Compartment / 将储尘室复位

1. Close the trapdoor and insert the hook on the dust compartment into the groove on the main body.

1. 关上储尘室盖，将储尘室上搭钩插入本体上的凹槽内。

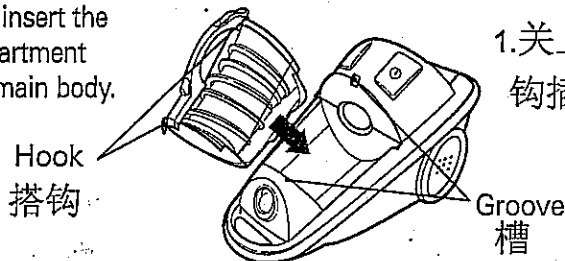

2. Push the dust compartment into the main body as shown to reattach, then lock the dust compartment by pushing button A.

2. 如箭头所示用力按下，将储尘室复位。

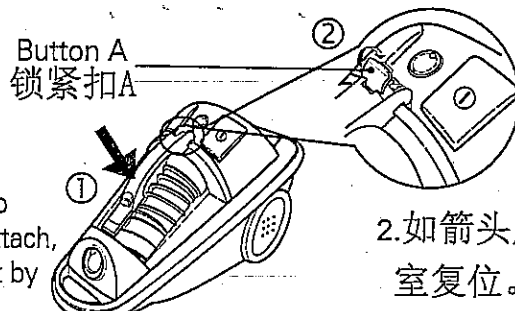

CARE OF FILTER / 清洗过滤网

1. Remove the dust compartment.
(refer to EMPTYING THE DUST COMPARTMENT PAGE)

2. Pull the duster handle upward to remove it, and then open the trapdoor.

3. Pinch the ribs of the main filter and pull out main filter.

• The main filter and prefilter will be removed at the same time.

4. Clean the main filter and prefilter with a soft-bristled brush and rinse with cold water. Allow both items to dry completely.

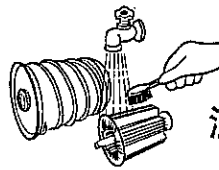
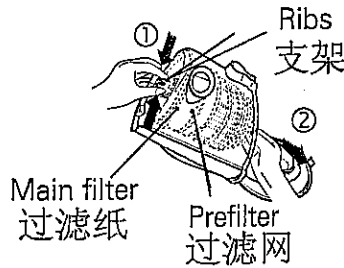
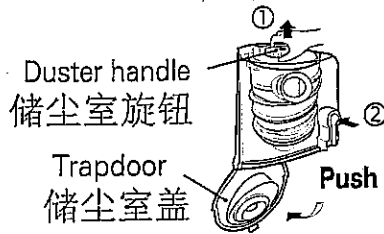

注意:

请不要使用尖硬毛刷清洗过滤器，这会损伤过滤器。

请勿尝试用电热吹风或衣物烘干机等干燥过滤器，热风会使过滤器弯曲。

Caution:

- Do not use a hard-bristled brush to clean filters. This may result in damage to the filters.
- Do not attempt to dry with a hair dryer or by placing in a clothes dryer. Hot air may cause the filters to warp.

Cleaning utensil / 除尘叉

To maintain optimum suction power, the dust filter fins should be kept clean of dirt.
为保持最佳吸尘力，请清除位于褶皱式过滤块上的灰尘。

- Clean the filter fins free of dirt with the forked end of cleaning utensil as shown.
- 请按图所示，使用除尘叉除去附在褶皱式过滤块上的灰尘。

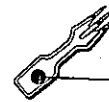
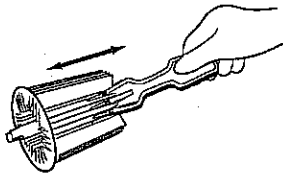

Cleaning utensil
除尘叉

Reattaching the filters / 将过滤器复位

1. Insert the main filter into the prefilter as shown.

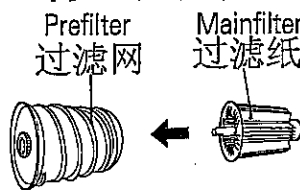

2. Hold onto the main filter and insert into the dust compartment.

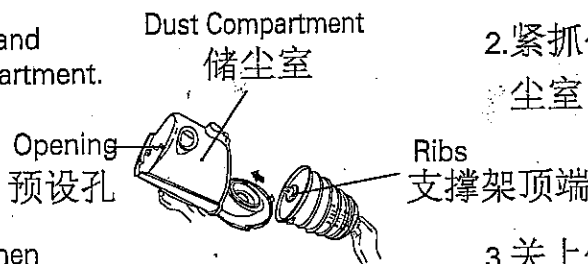

3. Close the trapdoor, and then attach the duster handle.

Duster handle
储尘室旋钮

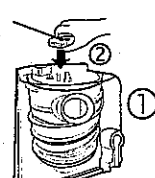

- Align the ribs of the main filter to match the shape of the opening in the dust compartment and press firmly to insert.

1. 如图所示将过滤纸插入过滤网内。

2. 紧抓住过滤纸组件，插入储尘室。

3. 关上储尘室盖，扣上旋钮。

- 将过滤纸组件顶端对准储尘室上预设孔，用力插入。

Thank you for your purchase of the Sanyo Vacuum Cleaner.
Please read these instructions carefully before using.

A FEW PRECAUTIONS

1. Operation without the dust compartment and /or filters in place will allow dust to enter the motor and could damage the vacuum cleaner.
2. Keep the vacuum cleaner away from stoves and other heat sources. Heat can deform and discolor the plastic parts of the unit.
3. Keep the vacuum cleaner free of insecticides. Do not wipe with benzine, thinner, petrol or other oils which might cause discoloration or cracking. To clean the body and hose, dampen a cloth with a mild detergent and wipe clean.
4. Blocking the suction inlet or allowing the dust to clog the hose will decrease the efficiency of the motor.
5. Be sure not to push the release button while carrying the vacuum cleaner.
6. Never try to vacuum the following objects. They may damage the unit or cause a fire.
 - * Wet things, mud, soil, and fluids
 - * Burning cigarettes
 - * Needles and razor blades
 - * Inflammable materials such as gasoline and thinner
7. The following kinds of treatment shorten hose life:
 - * Bending hose at an acute angle when storing
 - * Pulling the hose with excessive force
 - * Placing heavy objects on, or stepping on the hose
8. Pull out the plug from the power source after use. Grasp the plug-not the cord-when pulling out the plug.
Pulling on the cord may lead to shortcircuiting.
9. Long and continuous use causes the exhaust air and the body of the vacuum cleaner to become warm. This, however, does not denote malfunction.
10. When vacuuming places that are very dusty, and also when vacuuming regularly, empty the dust compartment before it becomes completely filled.
Frequent emptying lengthens the life of the motor and maintains strong suction power.
11. If the supply cord of this appliance is damaged, it must only be replaced by a repair shop appointed by the manufacturer, because special purpose tools are required.
12. Do not allow it to be used as a toy. Close attention is necessary when used by or near children or infirm persons.

HOW TO USE THE HOSE STAND / 软管架的使用方法

- The vacuum cleaner with the floor nozzle, wands and hose can be stored while still connected.

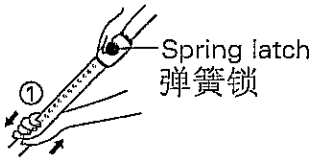

- 真空吸尘器可在与吸尘嘴、接长管和软管连接着的情况下存放。

① Hold spring latch and pull out or push in wand to required length.



① 握住弹簧锁，将伸缩管拉至所需的长度。

② Insert the wand holder into the wand holder hole.

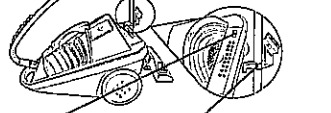

② 将管子卡箍插入管子卡箍孔。

③ Hold the hose and wind it around the pipe.



③ 握住软管将它卷绕在管子上。

Caution:

Do not carry the vacuum cleaner while it is in the storage position.

注意:

在真空吸尘器处于存放位置时不要搬动它。

(Injury or damage may result if the hose or coupling pipe becomes unattached.)

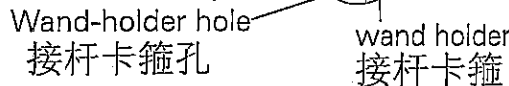

(如果软管或连接管脱开，则会导致意外事故或损坏。)

REPLACING THE FILTER / 更换过滤块

- Under normal usage, the HEPA filter or static filter will not require replacement; however, vacuuming large amounts of extremely fine dust, powder or similar material over a long period of time may decrease airflow performance through the filter. If this occurs, it may become necessary to replace the HEPA filter or static filter. Only use genuine Sanyo replacement filters.
- 在正常情况下使用HEPA过滤块或S级过滤块无需更换,但是,长期吸大量的灰尘,粉尘或类似物质,将导致通过过滤块气流减少。如果发生这种情况,请更换HEPA过滤块或S级过滤块。请只用真正的三洋过滤块。

1. Unscrew and pull the filter cover away from the vacuum cleaner.

Screw 螺丝

1. 拧松和取下过滤块盖。

Filter cover 过滤块盖

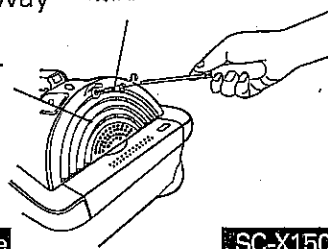

2. Remove the HEPA filter or static filter.

2. 取出HEPA过滤块或S级过滤块。

SC-X2100A Type

SC-X1500 Type

HEPA filter HEPA过滤块

Static filter S级过滤块

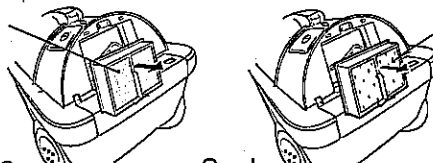

3. Insert a new HEPA filter or static filter with the seal to the inside of the vacuum cleaner. Reattach the filter cover.

3. 将新HEPA过滤块或S级过滤块插入吸尘器, 装上过滤块盖。

Seal 密封条

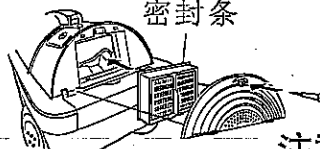

Caution:

- Do not attempt to wash the HEPA filter or static filter.
- Always replace the old filter with a new one.
- Be sure that seal on the HEPA filter or static filter is inserted towards the inside of the vacuum cleaner.
- The filter cover should be correctly oriented when it is reattached.

注意:

- 请勿试图清洗HEPA过滤块或S级过滤块。
- 使用新过滤块替换旧的。
- 确认HEPA过滤块或S级过滤块已插入吸尘器中。

UNCLOGGING THE BYPASS TUBE ASS'Y / 清除导风管中的垃圾

- When the bypass tube ass'y is clogged with dust, remove it in the following manner.
- 当导风管组件被灰尘堵塞时，请按下述方法来清除灰尘。

1. Unscrew and pull the dust inspection cover away from the vacuum cleaner.

Dust inspection cover
导风管盖

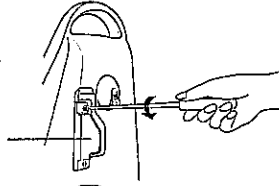

1. 拧下螺线并取下导风管盖。

2. Push out the dust clogging the bypass tube ass'y.

Bypass tube ass'y
导风管

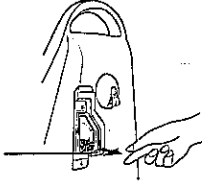

2. 取出导风管中的堵塞物。

3. Reattach the dust inspection cover.

Dust inspection cover
导风管盖

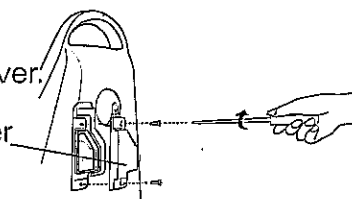

3. 装上导风管盖

Caution:

- The dust inspection cover should be correctly oriented when it is reattached.

注意:

- 在重新安装导风管盖时，请确认是否安装正确。

CARE AND MAINTENANCE

If you have a problem with your vacuum cleaner, consult the handy guide below. If the vacuum cleaner is malfunctioning, do not operate it. Contact your dealer or the nearest Sanyo Service Center.

Problem	Possible cause	Possible solution
(1) Cleaner won't run.	1. Not firmly plugged in. 2. No voltage in wall outlet.	1. Plug unit in firmly. 2. Check fuse or breaker.
(2) Suction does not increase after cleaning out the dirt.	1. Filter dirty. 2. Clogged floor nozzle or hose or bypass tube ass'y.	1. Clean out the filter. 2. Clean out floor nozzle or hose or bypass tube ass'y.
(3) Cord doesn't fully rewind.	1. Cord twisted or uneven.	1. Pull out cord and rewind.

维护保养

如果你的吸尘器有问题，请查阅下表。如果吸尘器功能不正常，请不要使用它。此时，可求教你的销售店或就近的三洋维修服务中心。

问题	可能原因	解决办法
(1) 吸尘器不运转。	1. 电源插头未正确插好。 2. 墙上电源插座没有电。	1. 正确地插好电源插头。 2. 检查保险丝或断路器。
(2) 在清除灰尘后，吸力不增加。	1. 过滤网脏。 2. T型吸尘头、软管或导风管堵塞。	1. 清理过滤网。 2. 清理T型吸尘头、软管或导风管。
(3) 电源线不完全缩进。	1. 电源线扭曲或不直。	1. 拉出电源线，重新卷绕。

SANYO 三洋

SANYO Electric Co., Ltd.

NAME AND FUNCTION OF PARTS (Assemble as indicated in the center illustration.) / 部件名称和功能 (如中央图示进行组装)

* In the illustration the SC-X2100A is explained / * 此说明书以机种SC-X2100A之插图进行说明

* SC-X2100A only / * 仅限机种SC-X2100A

Vacuum Power Adjustment Ring / 吸尘功率调节环

- The full vacuum power of the cleaner may be too strong in certain cases, for instance when vacuuming curtains and draperies. In these cases, turn the vacuum power adjustment ring (on the hose) to control the vacuum power. Match the hole in the ring with the hose hole to reduce the power.
- 对于某些材料,如窗帘和绸缎呢绒等来说,全吸尘功率可能会太强,在这种情况下,转动吸尘功率调节环(在软管上)以调节吸尘功率。当调节环上的小孔与软管上的小孔对准时,吸尘功率就会变小。

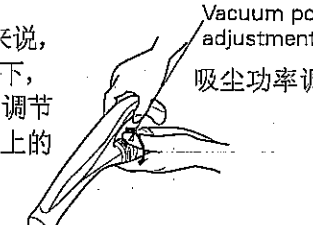

Vacuum power adjustment ring
吸尘功率调节环

Switch / 开关

- Start or stop vacuum cleaner by pushing on the switch.
- 由按下开关来启动或停止吸尘器。

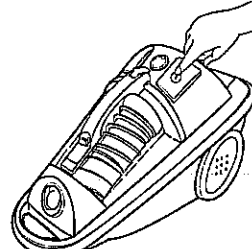

Power Control / 功率控制

- Set the POWER CONTROL to MAX for maximum suction. In the position MIN the suction power is decreased.
- 把POWER CONTROL置于MAX位置可得到最大的吸尘功率。置于MIN位置时吸尘功率将减少。



Cord Rewind Button / 电源线卷回钮

- To pull the cord back into the unit, press the cord rewind button.
- 注意: * Hold the plug when rewinding the cord so that the plug does not damage furniture, hands, the vacuum cleaner or the cord by hitting them. Holding the plug will make rewinding smoother.
- 要将电源线卷回到机内时,请按下电源线卷回钮。
- 注意: * 在卷回电源线时应握住电源插头,以免插头撞击到家具、手、吸尘器或电源线而使它们受到损伤。握住插头能确保平稳地卷绕。

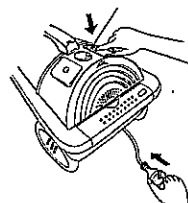

Cord rewind button
电源线卷回钮

Expansion Pipe/ 伸缩管

- The pipe is adjustable according to the height of the user.
- 可根据使用人的身高来调节伸缩管长度。
- (How to expand/contract the pipe)
- Hold spring latch and pull out or push in wand to required length.
- *Make sure that you hear a "clicking" sound.
- <伸缩方法>
- 握住弹簧锁,将伸缩管拉至所需长度。
- *请确认是否听到“卡嗒”一声。

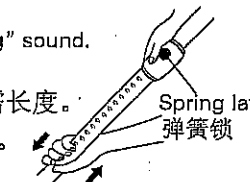

Spring latch
弹簧锁

Caution:
*Please do not place your hand on the spring latch during operation.
*Please do hold spring latch when adjusting the length.

注意:
*请勿按着伸缩管的弹簧锁进行吸尘操作。
*在调节长度时,务必一边握住弹簧锁一边进行调节。

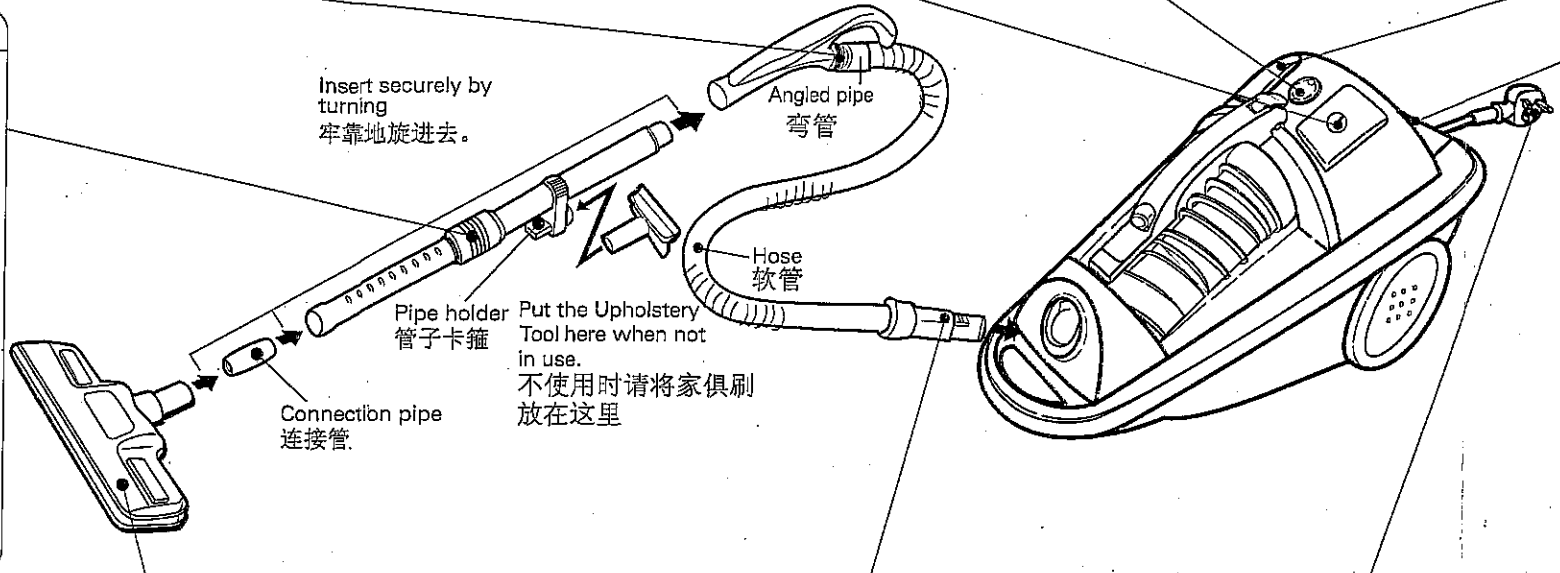

Insert securely by turning
牢靠地旋进去。

Angled pipe
弯管

Hose
软管

Pipe holder
管子卡箍

Put the Upholstery Tool here when not in use.
不使用时请将家具刷放在这里

Connection pipe
连接管

Handy Attachment Compartment / 附件存仓

- The compartment stores a crevice tool, cleaning utensil and round brush.
- 仓内存放有一个尖嘴头,除尘叉和圆头刷。



Cleaning utensil
除尘叉

Crevice tool
尖嘴头

Round brush
圆头刷

Attachments / 附件

Crevice tool / 尖嘴头

- For vacuuming edges and gaps.
- 适于角落和缝隙的吸尘。

Round brush / 圆头刷

- The head of the brush can rotate.
- For vacuuming fragile or easily scratched items.
- 刷子头部可以旋转。
- 用于脆弱或易破损之物的吸尘。

Upholstery tool / 家具刷

- For vacuuming furnitures
- 用于家具的吸尘

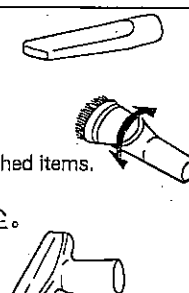

Floor Nozzle / T型吸尘头

- The two-way floor nozzle has lever with two positions.
- 两用T型吸尘头具有双位控制杆。

FLOOR

FLOOR:
For vacuuming wooden floors, linoleum or plastic covered floors.

FLOOR: 用于木质地板、亚麻油毡或塑料铺面地板的吸尘。

RUG

RUG:
For vacuuming rugs and carpets.

RUG: 用于厚毛毯和地毯的吸尘。

Hose Stopper / 软管上推器

- Insert the hose all the way up to the hose stopper.
- To detach it, press the hose stopper and pull the hose toward you.
- 请将软管尽力插到软管上推器。
- 取下上推器时,请按上推器,并朝外拔出软管。

Cord and Plug / 电源线和插头

- Pull out the cord and connect the plug. Do not extend the cord from the unit beyond the red marker line.
- 拉出电源线,然后连接插头。从本机中拉出电源线时,勿使其超过红色标线。

Unclogging the Hose / 清理软管

- When the hose is clogged with dust, remove it in the following manner:
- 1) Pull out the angled pipe by turning the removal ring in either direction.
- 2) Use a vinyl garden hose to push out the dust clogging the hose.
- 3) Insert the angled pipe in place and return the ring to its original position.
- Do not use the hose without the angled pipe in place. If the hose is used without the angled pipe, the hose will bend excessively, causing it to break.
- 当软管被灰尘堵塞时,请按下述方法来清除灰尘:
- 1) 朝任一方向转动拆卸环来拉出弯管。
- 2) 用乙烯软管推出堵在软管内的灰尘。
- 3) 将弯管插入到位,把环转回到原来位置。
- 请勿在没有装上弯管的情况下使用软管。如果没有弯管就使用软管,则软管可能会极度弯曲而引起破裂。

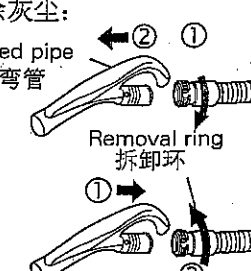

Angled pipe
弯管

Removal ring
拆卸环