

SANYO

COMPACT
disc
DIGITAL AUDIO

FXD-815GD

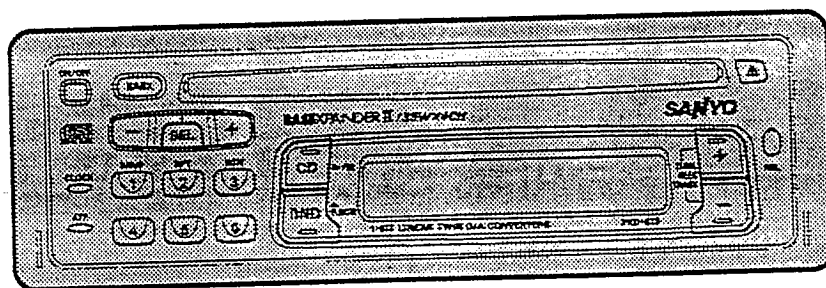

High Power AM/FM Stereo Receiver
Compact Disc Player ISO Mounting
with Removable Trim Ring

FXD-815GD

(English)	OPERATING INSTRUCTIONS	1~18
(Français)	MODE D'EMPLOI	19~36
(Nederlands)	BEDIENING SHANDLEIDING	37~54
(Español)	LIBRITO DE INSTRUCCIONES	55~72
(Portugués)	INSTRUOÓES DE UTILIZACÁO	73~90
(中國語)	使用说明书	91~108

GB

F

NL

E

P

中

DIGITAL DISPLAY

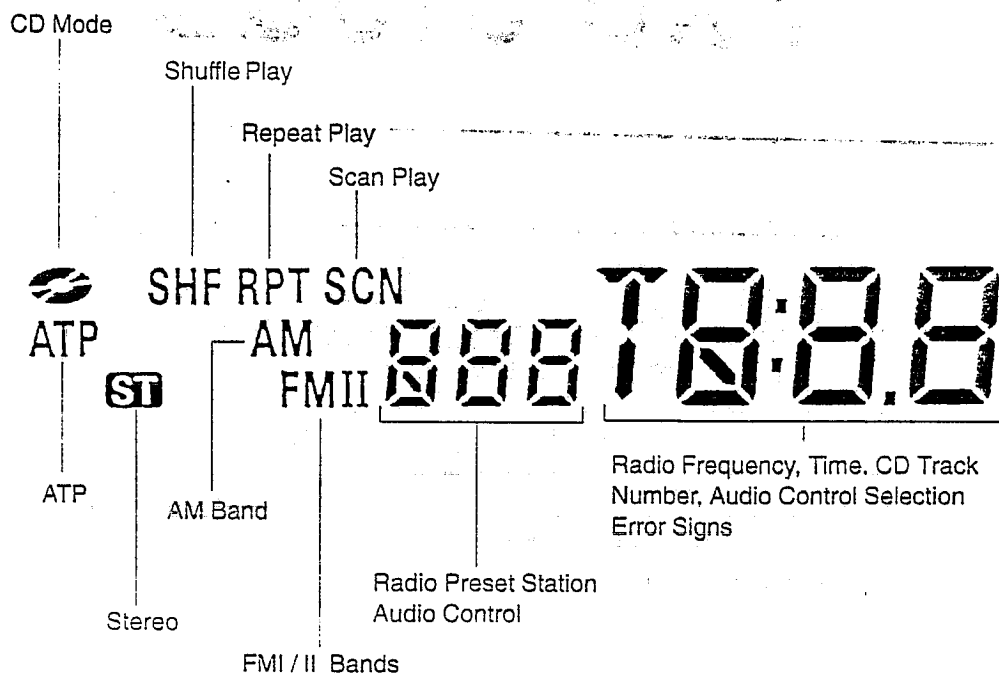

COMPACT DISC CARE

Dirt, dust, scratches and warpage can cause a deterioration in the sound or intermittent skipping some tracks during play.



- This unit has been designed to play compact discs bearing the identification logo shown on the left. No other discs can be played.

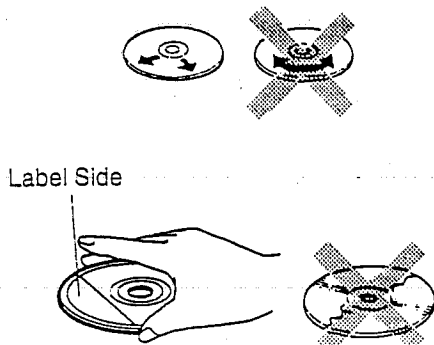

Label Side

- Fingerprints and dust should be carefully wiped off the signal surface of the disc (glossy side) with a soft cloth. Wipe in a straight motion from the inside to the outside of the disc. Unlike conventional records, the compact disc has no grooves to collect dust and debris. Small dust particles will have no effect on reproduction quality.
- Do not insert a disc which is cracked into the unit.
- Do not apply paper or write anything on the surface of the disc.

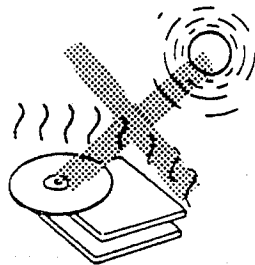

- To prevent warping the disc, do not expose it to direct sunlight, high humidity or high temperatures for extended periods of time.



Benzene Thinner Cleaning spray

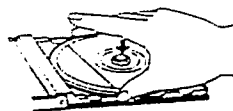

- Never use chemicals such as record cleaning sprays, antistatic sprays or fluids, benzene or thinner to clean compact discs. These chemicals will permanently damage the plastic surface of the disc.
- When not using the disc player for extended periods of time, remove the compact disc and return it to the plastic storage case. This will protect the disc from dust and exposure to the sun.

CONTENTS

COMPACT DISC CARE	3
DETACHABLE FRONT PANEL	4
GENERAL OPERATION	4
RADIO OPERATION	7
CD OPERATION	9
ERROR SIGNS	11
CLOCK	11
HINTS FOR PROPER AND SAFE OPERATION	12
TROUBLESHOOTING	13
ACCESSORIES AND HARDWARE	14
INSTALLATION	14
UNIT REMOVAL	16
ELECTRICAL CONNECTIONS	17
LINE TERMINAL CONNECTIONS	18

CAUTION

- This unit is designed to operate on 12 volts DC, NEGATIVE ground electrical systems only.
- When fuse replacement is necessary, use only a 10 amp fuse. Do not replace with a higher rated fuse. If the fuse blows often, carefully check all electrical connections for any short circuits and have your car's voltage regulator checked also.
- Do not install the unit where it will be exposed to direct sunlight or hot air discharged from the car heater.
- Do not expose the unit to water or moisture.
- To avoid damaging the unit, never insert anything other than a compact disc into the disc slot.
- This unit should not be adjusted or repaired by anyone except qualified service personnel. If servicing is required, return the unit to an authorized SANYO car audio dealer.
- When the power supply cable is connected for the first time, press the reset button.
- Use of Controls or adjustments or performance of procedures other than those specified herein may result in hazardous radiation exposure.
- Changes or modifications not expressly approved by Sanyo may void the user's authority to operate this equipment.

CD SELECT BUTTON (CD) 6

Press the CD button  to switch from radio or tape mode to CD mode.

Note

If no CD is loaded, "no CD" appears in the display.

CLOCK BUTTON 7

Press the CLOCK button  to switch between the clock and audio display. When an audio function is performed while the time display is selected, the audio display will appear for 5 seconds, then the display will return to the time mode.

RESET BUTTON 10

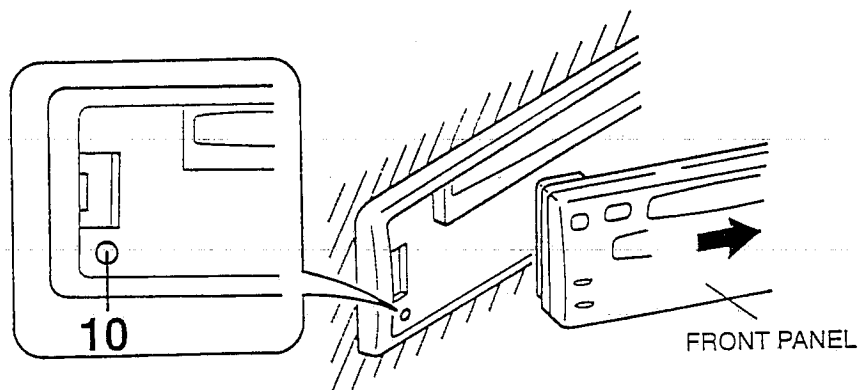

The RESET button  is recessed to prevent accidental engagement.

Remove the front panel and gently press the RESET button with a pointed object to reset the unit under the following conditions;



- If the unit will not load or eject a compact disc.

When the reset button is pressed, all memory settings (radio station presets and clock time) are cancelled and the system returns to the radio mode.

TO CANCEL THE BEEP TONES 8, 9

The unit emits a beep tone to confirm that a function button has been pressed. To cancel all beep tones.

1 Turn off the power.

2 With ACC on, press the ATP button  and preset #6 button  simultaneously for more than 3 seconds.

To turn the beep tones on again, repeat steps **1** and **2**.

RADIO OPERATION

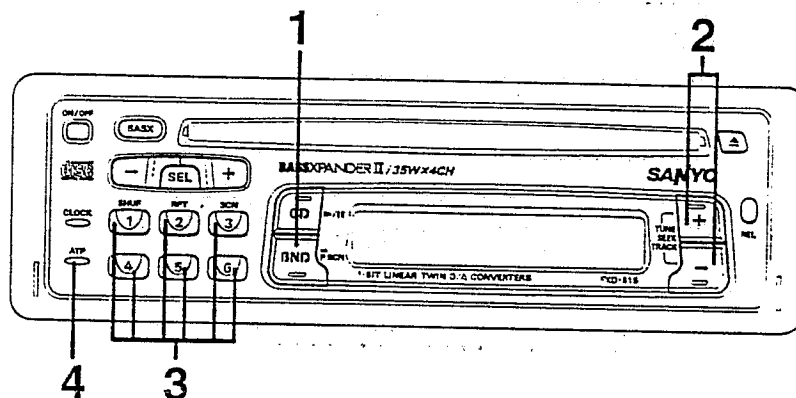

SELECTING RADIO MODE

Press the BAND button ① with the power on to switch from CD* to the radio mode. Each time the BAND button is pressed, the selected band changes as shown below.

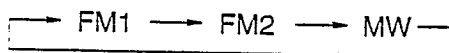

RADIO TUNING 2

- Automatic tuning Press the TUNE/SEEK/TRACK ⊕ or ⊖ button ② for more than 2 seconds. When the button is released, the system will start automatic tuning and stop at the next receivable station.
- Manual tuning To select higher frequency stations, press the ⊕ button for less than 0.5 seconds. To select lower frequency stations, press the ⊖ button for less than 0.5 seconds. To quickly scan up or down in frequency, press and hold the ⊕ or ⊖ button. Release the button when the display approaches the desired frequency, then press and release the button repeatedly until the desired frequency is displayed. A flashing decimal point in the frequency display indicates that the system is receiving a station 50 kHz higher than the displayed frequency.

STORING PRESET STATIONS 3

The preset buttons ③ can be used to store 6 stations in each band (FM1, FM2, and MW) for convenient access to your favorite stations.

- Programming stations ...
 - 1 Select the desired band, then tune in the station you want to store in memory.
 - 2 Press and hold one of the preset buttons for more than 2 seconds. Repeat steps 1 and 2 to program additional stations.
- Quick tuning Select the desired band, then press one of the six preset buttons.

ATP (AUTO TRAVEL PRESET) OPERATION 4

The Auto Travel Preset function searches for and memorizes the 6 strongest stations in one of the two bands (FM, MW) in order of signal strength.

This feature is useful when you are driving in an unfamiliar location and want to memorize local stations without changing the standard preset stations.

A total of 12 stations (6 FM and 6 MW) can be programmed.

- To set the stations
 - 1 Select the desired band.
 - 2 Press and hold the ATP button  for more than 2 seconds. "ATP" appears in the display.
 - When the stations have been memorized, scanning stops and the strongest station is selected.

Quick Tuning of ATP Stations





- Select the desired band.
 - Press the ATP button if the "ATP" indicator does not appear in the display.
 - Press the ATP button for less than 1 second to select the ATP presets in sequence. If a total of six stations cannot be preset "----" will be displayed for the empty channels.
- To scan programmed stations ... See "PRESET-SCAN-BUTTON OPERATION".

Notes

- If no station can be received, "----" appears in the display.
- If fewer than 6 stations can be received, the system will memorize as many stations as possible, then select the one memorized first.

PRESET-SCAN-BUTTON OPERATION 1, 4

This function scans each of the preset stations stored in the selected band (both manual preset and auto travel presets).

- 1 Select the desired band or ATP mode.
Press the BAND/P.SCAN button  for FM1, FM2 or MW, or press the ATP button  for less than 0.5 seconds to select the ATP mode.
- 2 Press the BAND/P.SCAN button  for more than 2 seconds. The system will select and receive each preset station for 5 seconds.
- 3 To stop scanning and retain the station currently selected, press the BAND/P.SCAN button  again during this five-second period.

CD OPERATION

The compact disc player will accept 5" and 3" CDs (without the use of an adaptor).

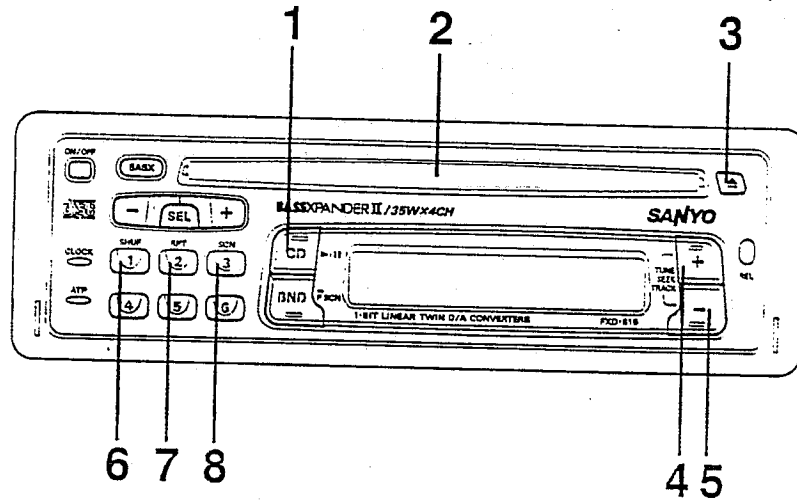

SWITCHING TO CD MODE 1

Press the CD button  with the power on to switch from radio mode to CD mode. When the CD mode is switched on while a disc is loaded, play resumes from the point at which play was stopped.





When the entire disc has played, the unit returns to the first track and play resumes. The CD player continues playing the disc until the CD button is pressed again, the ON/OFF button is pressed, the BAND button is pressed, or the disc is ejected.

If you switch off the CD mode or the vehicle's ignition while a CD is playing, then switch back to CD mode or turn on the ignition again, the CD resumes play from the point where you last stopped. When the CD is switched on again, the mechanism requires approximately 5 seconds to initialize before play resumes.

LOADING A DISC 2

Insert a CD into the disc slot  with the label side facing up and CD play starts. The loading mechanism automatically pulls the disc into the unit and play starts with the first track on the disc. The "CD Mode" indicator and the track number appear in the display.

PLACING THE CD IN PAUSE MODE 1

While playing a CD, press the CD  button . To resume playing, press the CD  button  again.

EJECTING THE DISC 3

Press the EJECT button .

Note

If the CD player is kept in pause mode for more than 5 minutes, the system will shut off.

ERROR SIGNS

If a problem should occur while operating the CD player, one of the following error signs may be displayed.

Error Sign	Cause	Remedy
E01	Loading and / or unloading has failed.	Insert the disc properly.
E07	The disc was inserted incorrectly	Insert the disc properly.
	The disc is dirty.	Clean the disc.
	The disc is defective.	Use another disc.
no cd	No disc is loaded.	Load a disc.

Note

- If the unit does not work at all, press the RESET button.
- When E01 or E07 is displayed, a CD is ejected automatically. In this case, remove the CD from the disc slot and load it again, or press the RESET button.

CLOCK

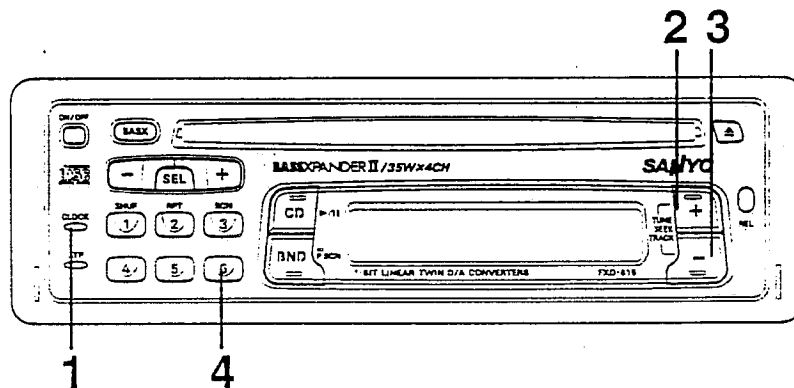

ADJUSTING THE TIME 1, 2, 3

You can adjust the clock while the time is displayed.

To adjust the time, press the TUNE/SEEK/TRACK ⊕② or ⊖③ button while pressing the CLOCK button ①.

To adjust the hour, press the ⊕ button.

To adjust the minutes, press the ⊖ button.

To advance the minutes rapidly, hold the ⊖ or ⊕ button continuously.

SKIPPING TRACKS 4, 5

Press the TRACK ⊕ button ④ to skip to the beginning of the next track.
Press the TRACK ⊖ button ⑤ to skip to the beginning of the track currently playing.
Press the TRACK ⊖ button ⑤ twice to skip to the beginning of the previous track.
Press and hold the TRACK ⊕ or ⊖ button for more than 1.5 seconds to search quickly (with sound) in the forward or reverse direction.
When the button is released, the CD resumes normal play.

SHUFFLE MODE 4, 5, 6

This function plays the tracks on a CD in random order.
Press the SHUF button ⑥ to begin shuffle play.
Press the TRACK ⊕ or ⊖ button to select another random track.
To cancel this mode, press the SHUF button ⑥ again or eject the CD.

Note

If a disc is already loaded under the following conditions, shuffle play will resume from the point at which play was stopped:

- *If the vehicle ignition is turned off, then on again.*
- *If the power is switched off, then on again with the ON/OFF button.*

REPEAT MODE 1, 7

Press the RPT button ⑦ to play the current track repeatedly.
To cancel this mode, press the RPT button ⑦ again or eject the CD.

Note

If a disc is already loaded under the following conditions, repeat play will resume:

- *If the vehicle ignition is switched off, then on again.*
- *If the power is switched off, then on again with the ON/OFF button.*

SCAN MODE (PLAYING THE BEGINNING OF EACH TRACK) 8

This function plays the first 10 seconds of each track sequentially.
Press the SCN button ⑧ to begin the SCAN mode.
The system will remain in this mode until it is cancelled.

To cancel this mode, press the SCN button ⑧ again.

Note

Scan mode will be cancelled when the vehicle ignition is turned off, when the ON/OFF button is pressed, or when the disc is ejected.

CLOCK RESET 1, 4

You can reset the clock to the nearest half-hour while the time is displayed, even when the power is switched off.

Press the PRESET button 6 $\text{\textcircled{4}}$ while holding the CLOCK button to skip to the nearest half-hour as follows:

Example: 3:00-3:29 \rightarrow 3:00
3:30-3:59 \rightarrow 4:00

Notes

- This unit uses a 12-hour clock.
- The clock function and radio presets are retained in memory when the audio is switched off.

HINTS FOR PROPER AND SAFE OPERATION

• Condensation

Moisture can condense on the optical lens of the CD player during humid or rainy days, or after the car heater is turned on. If this occurs the disc player may not function properly. To remedy the situation, remove the disc from the unit and wait approximately one hour. This should allow the moisture to evaporate and restore normal operation.

• Temperature Consideration

The unit may not operate correctly in extremely hot or cold temperatures. Avoid exposing the unit to extremely high or low temperatures.

• Interruptions in the sound (skipping)

When the car is driven on very rough surfaces, the sound from the CD player may skip and be interrupted. This will not cause any damage to the disc or the player. If this occurs, wait for the road surface to improve before using the CD player.

• Safety

For safer driving, keep the volume at a moderate level to enable you to hear outside sounds (such as emergency vehicle sirens).

• Cleaning the unit

Clean the unit with a soft, dry cloth. Stains should be removed by wiping the surfaces with a soft cloth immersed in lukewarm water and wrung dry. Never use strong chemicals or solvents. These will damage the finish of the unit.

• Disc care

When not using the disc player for extended periods, remove the compact disc and return it to the plastic storage case. Do not leave a disc partially ejected from the player. If an ejected disc remains in the loading slot for approximately 15 seconds, the player will reload the disc to prevent damage.

• Servicing

Should a problem develop, do not open the unit or try to repair it yourself. If servicing is required, bring the unit to a Sanyo Authorized Service Center.

TROUBLESHOOTING

Sometimes a simple operational error or a mistake in the wiring can appear to be a problem with the unit. Before having the unit serviced, refer to the troubleshooting chart below.

Symptom	Cause	Solution
The unit ejects the disc.	The disc was inserted upside down.	Insert the disc with the label facing up.
	The disc is extremely dirty.	Clean the disc.
	There is condensation on the optical lens.	Leave the disc player off for an hour or so, then try again.
The compact disc does not play when inserted into the unit.	The volume control is turned down.	Turn up the volume control.
	The power connections are not wired correctly.	Check the +12V and ground connections.
The CD cannot be loaded.	The shipping screw has not been removed.	Remove the shipping screw.
No power.	The vehicle ignition is switched off.	Switch the ignition to the "ON" or "ACC" position.
	The fuse is blown.	Replace the fuse with another 10A fuse.
The unit does not work properly (Eject, Load, Play).	The microcomputer has been affected by electrical noise.	Eject the disc, then insert it again.
		Press the RESET button.
The sound from the CD player skips.	The road surface is rough.	Wait for the road surface to improve before playing a disc.
	The unit is not mounted securely.	Install the unit securely.
	The disc is defective.	Try another disc. If it plays properly, the first disc may be defective.
	The disc is dirty.	Clean the disc as explained on page 3.
No radio reception.	The antenna cable is not connected.	Insert the antenna cable firmly into the antenna jack on the unit.
The radio does not stop on any stations when automatic tuning is used.	The signals are weak.	Select a station using manual tuning.
Function buttons do not operate.	The unit must be reset.	Press the RESET button.

ACCESSORIES AND HARDWARE

INSTALLATION

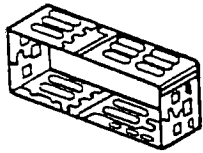

Mounting Bracket
(Half Sleeve) x 1

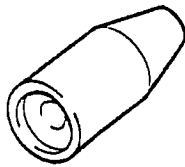

Mounting Grommet
x 1



Mounting Screw M5
x 1

SET REMOVAL

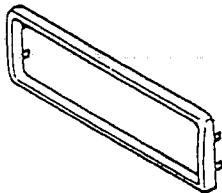

Removable Trim Ring
x 1

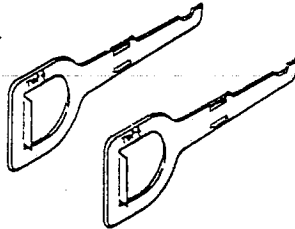

Unlock Levers
x 2

INSTALLATION

1. BEFORE INSTALLATION

- A) In order to protect the disc player from shocks during shipping, a shipping screw is attached to the disc player. Be sure to remove this screw before installing the unit into the vehicle. The compact disc player will not operate unless this screw has been removed.
- B) When mounting the unit in a car, keep the unit as level as possible. If the unit must be mounted at an angle, due to the design of the vehicle, make sure the unit does not tilt by more than 30°.

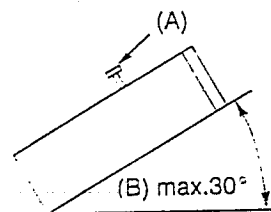

2. ISO MOUNTING WITH REMOVABLE TRIM RING

When mounting the unit into a DIN-standard cutout (182 × 53 mm) in the dashboard or console, attach the provided Removable Trim Ring to the unit.

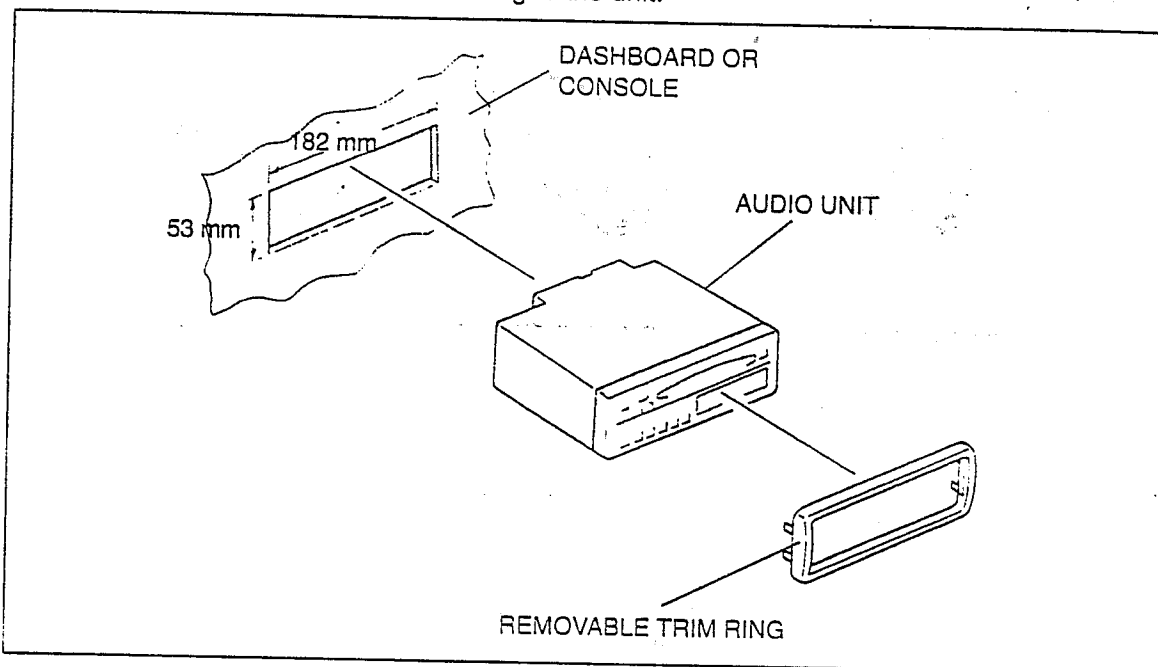

3. INSTALLATION PROCEDURES

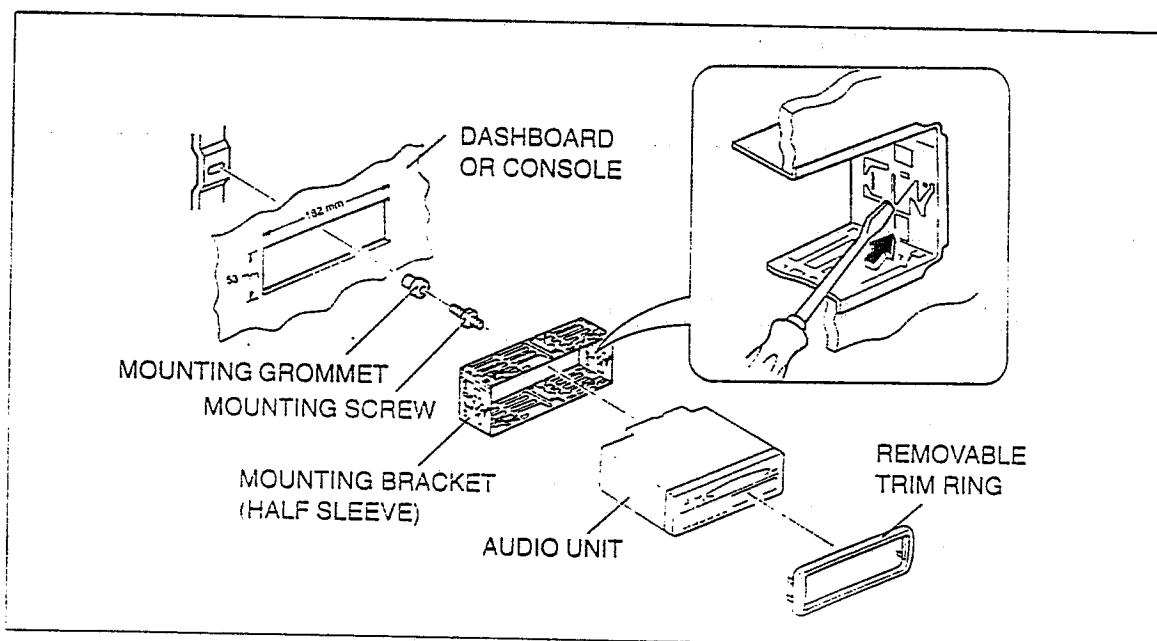

1. Insert the mounting bracket into the DIN-standard cutout (182 × 53 mm) in the dashboard or console.
2. Bend the mounting bracket stopper outward until the bracket fits snugly in the cutout.
3. Install the supplied mounting screw (M5) in the audio unit.
Cover the mounting screw with the supplied mounting grommet.
4. Push the unit into the mounting bracket until it locks in place.

UNIT REMOVAL

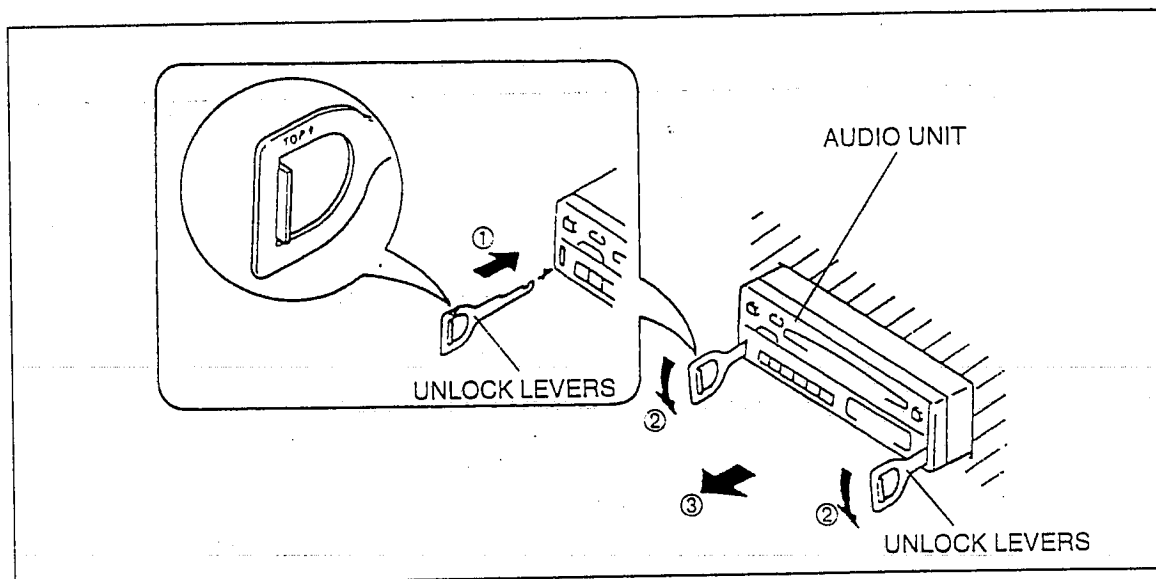

1. Insert the unlock levers into the slots on each side of the unit until they click into place.

Note

Take care not to insert the levers upside down.

2. While pressing the levers downward, pull the levers to remove the audio unit.

ELECTRICAL CONNECTIONS

WIRING

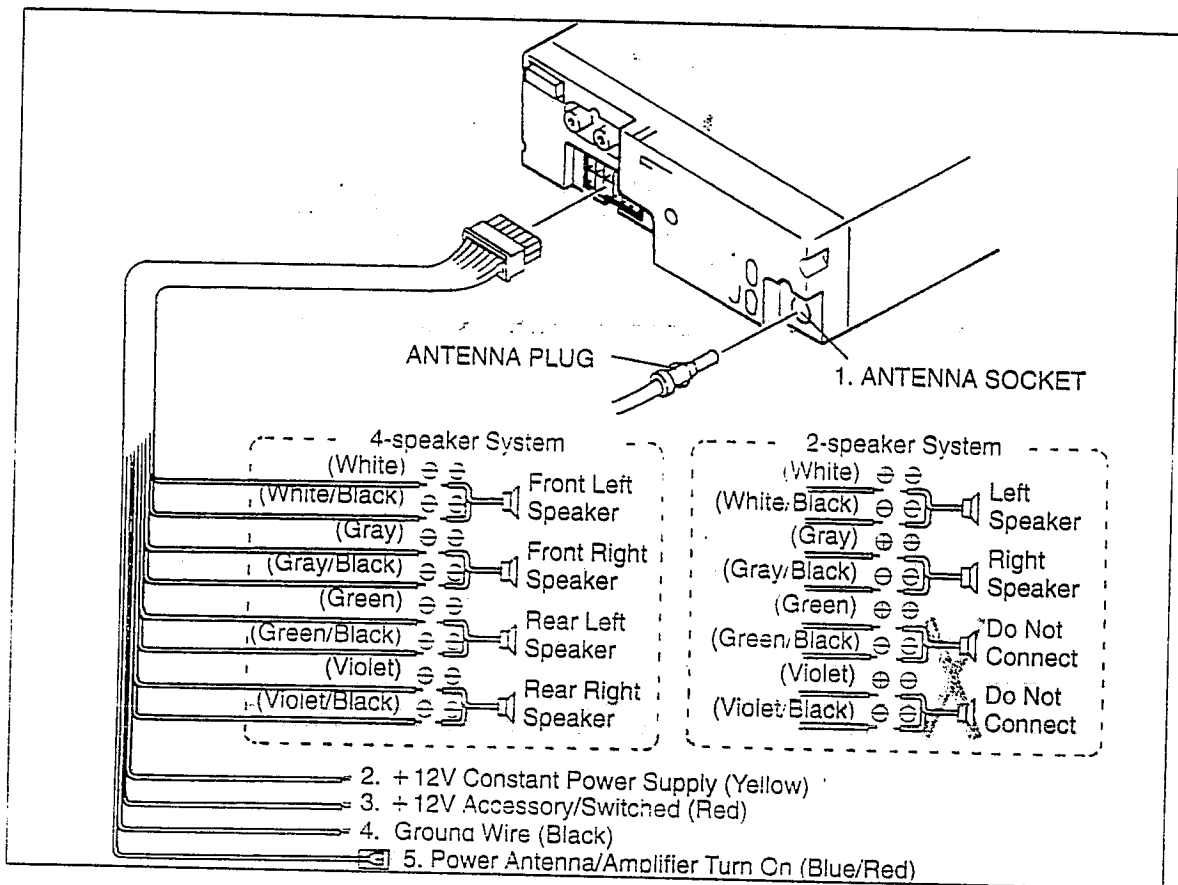

Caution

- DO NOT connect any speaker wires to the metal body or chassis of the vehicle.
- DO NOT connect the speaker common (-) wires to each other.
- Connect each speaker wire directly to each speaker terminal.
- All speaker common (-) wires must remain floating.

1 Antenna socket

- Insert the plug from the antenna installed in your vehicle into this socket. (If your vehicle has a dual antenna system, a dual antenna to single antenna cable adaptor may be required.)

2 +12V Constant Power Supply (Yellow)

- Connect this wire to the +12V power terminal which receives power continuously.

3 +12V Accessory/Switched (Red)

- Connect this wire to the terminal which receives power while the ignition switch is ON or in the ACCESSORY position.
- If the ignition switch does not have an ACC position, connect this wire to a +12V power terminal which receives power continuously. (Same as item 2.)

4 Ground wire (Black)

- Connect this wire to the vehicle chassis.

5 Power Antenna/Amplifier Turn On (Blue/Red)

- Connect this wire to the control terminal of a Power Antenna or an external amplifier.
- When not using a Power Antenna or an external amplifier, this wire is not connected.

Notes

- When using a two-speaker installation, the Green, Green/Black, Violet and Violet/Black wires, which are used for a four-speaker installation, are not used. The ends of these wires must be covered with electrical tape to prevent them from shorting to the unit or the vehicle chassis.
- When using a two-speaker installation, set the FADER control to the center position.
- When fuse replacement is necessary remove the blown fuse by using pliers. Then install the new 10 amp. fuse.

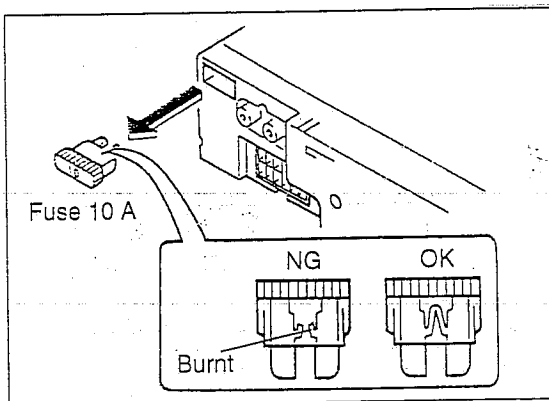

LINE TERMINAL CONNECTIONS

- Since this unit has output terminals, you can use an amplifier to upgrade your vehicle stereo system.

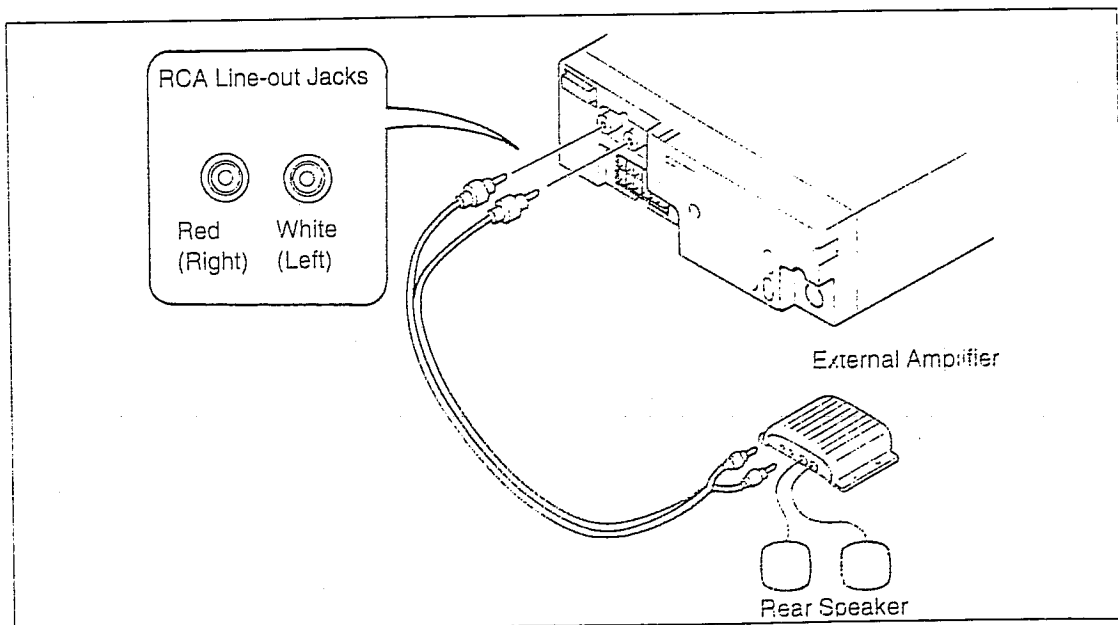

RCA Line-out Jacks (For Rear Speakers)

- Connect a patch cable (not supplied) from the White (left rear channel) and Red (right rear channel) RCA line output jacks of the unit to the line input terminals of the external amplifier.

