

FXD-C300

Compact Disc Auto Changer

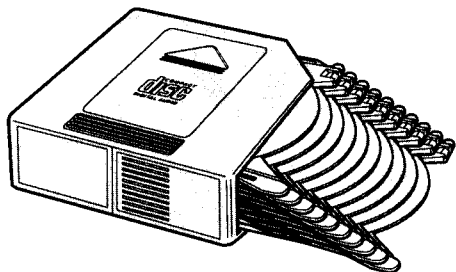
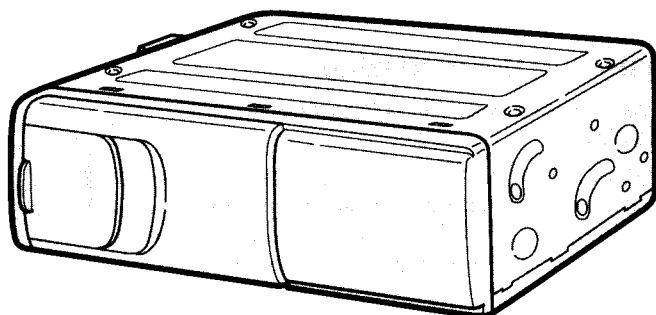

(English)	INSTALLATION MANUAL	1 ~ 6
(Deutsch)	EINBAU-HANDBUCH	7 ~ 13
(Français)	MANUEL D'INSTALLATION	14 ~ 19
(Nederlands)	HANDLEIDING VOOR INSTALLATIE	20 ~ 26
(Italiano)	MANUALE DI INSTALLAZIONE	27 ~ 32
(Español)	MANUAL DE INSTALACION	33 ~ 38
(Português)	MANUAL DE INSTALAÇÃO	39 ~ 45
(Svenska)	INSTALLATIONSANVISNING	46 ~ 51
(中國)	安裝說明書	52 ~ 57

GB

D

F

NL

I

E

P

S

中

CONTENTS

HINTS FOR CORRECT AND SAFE OPERATION	1
HOW TO USE THE MAGAZINE	1
PRECAUTIONS FOR HANDLING DISCS	2
INSTALLATION PARTS	2
ID (Identity) SWITCH FOR CD CHANGER	2
BEFORE INSTALLING THE UNIT	3
Transport lock screws	3
Installation and Wiring Precautions	3
Position of the built-in anti-vibration boards	3
WIRING	4
INSTALLATION	4 ~ 6
Procedure for Installation on Carpet (Horizontal Position)	4
Procedure for Installation on Carpet (Vertical Position)	5
Procedure for Installation on Carpet (At a 45° angle)	5
Procedure for Installation (Suspended Position)	6
HANDLING THE DISCS	6
TROUBLESHOOTING	6

GB

HINTS FOR CORRECT AND SAFE OPERATION

This CD Changer is designed to be operated only on +12 volt DC negative ground systems. The unit can not be used on +24 volt or positive ground systems.

The unit may not operate correctly in extremely hot or cold temperatures. The unit is equipped with a built in self protection circuit. When the temperature reaches a pre-set level, the protection circuit halts all unit operation. If this should happen, open a window and allow the car to cool.

Condensation

Moisture can condense on the laser lens of the CD changer during rainy and humid days, or right after the heater is turned on in the car. If this should happen the unit will not operate correctly. To remedy the situation, remove the magazine from the unit and wait approximately one hour. During this time the moisture will evaporate and the unit will operate normally.

Remove the magazine from the unit when it is not being used during hot weather and the CD changer is not used for long periods of time.

When using 8 cm CDs, use a 8 cm CD adapter which conforms to CD standards and be sure to load the CDs in trays No. 1, 3, 5, 7, and 9 (gray trays). Loading CDs into other trays will result in a malfunction.

HOW TO USE THE MAGAZINE

■ Loading a disc

- 1 Pick the tab on the magazine's disc tray and pull out only one of the trays.
- 2 Place the disc on the tray with its play surface facing up (label surface facing down).
 - * Each tray can accommodate only one disc.
 - * "E-07" appears about 8 seconds if the disc is placed upside down.
- 3 Press the tab on the disc tray to store the tray back in the magazine.
 - * Up to ten discs can be loaded.
 - * Use the 8 cm CD adapter for 8 cm discs. (See page 2)

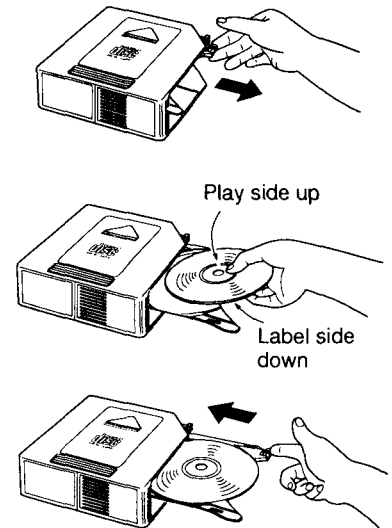

■ Installing the magazine

- 1 Slide the door toward the right until it locks into place.
- 2 First check that the magazine with the discs inside has its top side facing up and that it is pointed in the right direction for installation. Push it in until it clicks into place, indicating that it is now locked.
 - * When the magazine is used for the first time, it will not lock into place unless the power supply has been connected.

● Ejecting the magazine

- 1 Slide the door toward the right until it locks into place.
- 2 Press the eject button (▲) to remove the magazine.

Notes: Be absolutely sure to close the door after having inserted or ejected the magazine. Dust or dirt finding its way inside may cause malfunctioning of the unit.

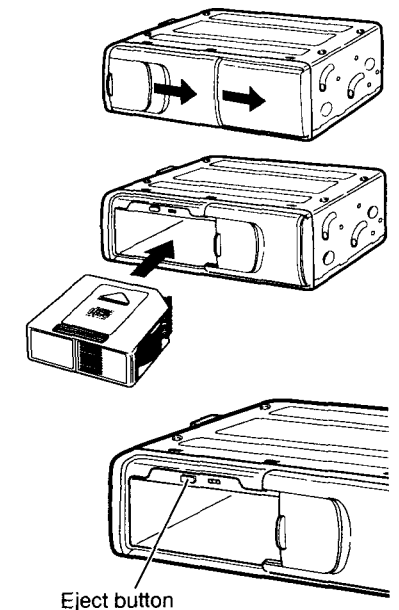

PRECAUTIONS FOR HANDLING DISCS

■ With new discs

The symptoms described below sometimes occur when new discs are used.

- The disc is not played even when it is loaded.
- Operation changes to the next disc before the first disc has a chance to be played.
- The same disc is played over and over again.
- The designated disc is not played.

These symptoms occur when there are burrs on the center hole or outside circumference of the disc and, as a result, the disc has not been loaded properly or the disc catches on something inside the magazine. In cases like these, remove the burrs using a ball-point pen or similar implement, as shown in the figure on the right.

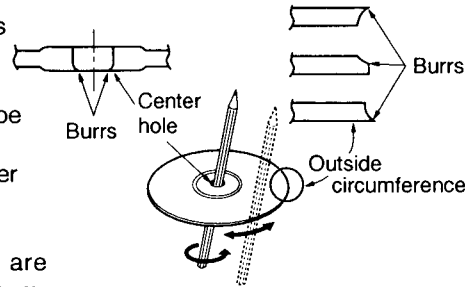

Remove all plastic particles of burr from surfaces of disc before loading in magazine.

■ With 8 cm CDs

When using 8 cm CDs, use a 8 cm CD adapter which conforms to CD standards and be sure to load the CDs in trays No. 1, 3, 5, 7, and 9 (gray trays). Loading CDs into other trays will result in a malfunction. Be sure to attach the disc properly to the catches provided on the adapter. If the disc is not attached correctly, it may come free inside the magazine or play mechanism, rendering the unit inoperable.

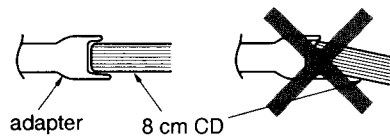
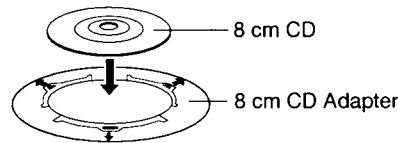

■ Storing the 8 cm CD adapters

Under no circumstances must an empty 8 cm CD adapter be loaded inside the magazine. If this warning is not heeded, the adapter will remain inside the mechanism, rendering the unit inoperable.

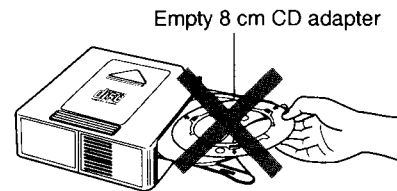

WARNING

- Although protective film is being marketed as CD accessories, use of these products will result in malfunctions and should absolutely be avoided.

INSTALLATION PARTS

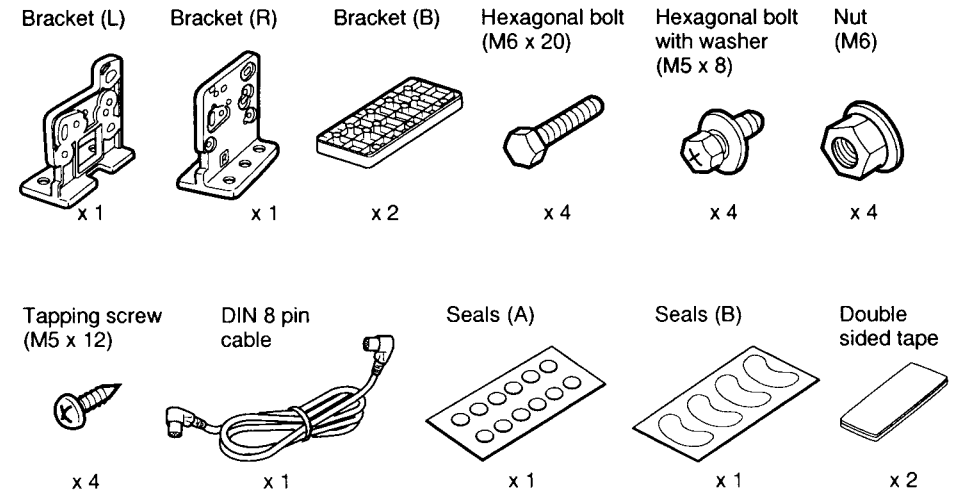

ID (Identity) SWITCH FOR CD CHANGER

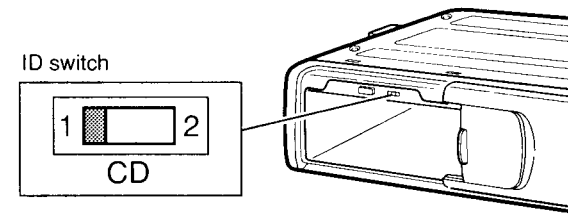

By using the separately sold Divider unit (FTP-CH1S), an additional SANYO CD changer can be installed. When an additional CD changer has been attached in this fashion, the ID switch is used to indicate the number of each respective changer unit.

- When changer is used independently
 - * The ID switch is initially set to "1" when shipped.
- When changer is used as additional changer unit

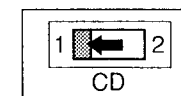
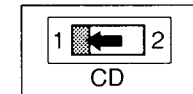

1st unit

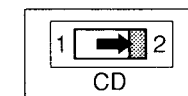

2nd unit (additional changer unit)

- * Use a ballpoint pen or similar fine-tipped implement to change the orientation of the switch.

GB

BEFORE INSTALLING THE UNIT

Transport Lock Screws

The mechanism in the CD changer is “locked” into place during shipment by the transport screws. Be sure to remove the screws prior to installation.

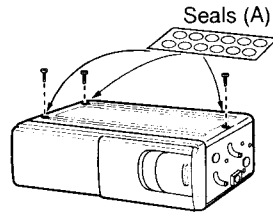

Caution

After removing the transport lock screws, place the supplied seals (A) over the screw holes. Also, place the seals (A) over the holes which are not used for installation. These seals are used to keep dust, which could cause a malfunction, out of the unit.

Installation and Wiring Precautions

- To prevent a short-circuit,
 - Be sure to turn off the ignition and remove the negative (-) battery cable prior to installation.

Note

If the changer is to be installed in a car that is equipped with an on-board drive or navigation computer, do not disconnect the battery cable. If the cable is disconnected, the computer memory may be lost. Under these conditions, use extra caution to avoid causing a short circuit during installation.

GB

- Do not install the unit in the following locations.
 - Locations exposed to direct sunlight.
 - Where hot air is discharged from the car heater.
 - When proper installation is not possible and where a great deal of vibration is generated.
- Be sure to use the supplied brackets and screws.
 - When installing the unit, do not use any screws that are part of the brake or steering system.
- This unit cannot be installed in any way except that which is authorized (on its side, on its end, at a 45° angle or suspended). Installing it with its side facing down or upside down can cause malfunctioning.

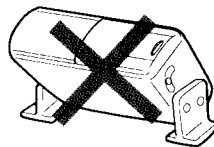
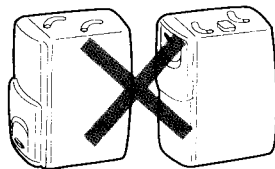

Position of the built-in anti-vibration boards

This unit can be installed horizontally (suspended), vertically, and at a 45° angle. Once the installation position has been decided, it's necessary to set the position of the built-in anti-vibration boards inside the unit. Please do this before performing the procedure listed below. Vibration may cause the disc to skip if the unit is used before properly setting the anti-vibration boards.

- At the time of shipping, the built-in anti-vibration boards are set for horizontal installation “H”.
- There are 2 built-in anti-vibration boards on each side.**
- Set the anti-vibration board position with a Philips screwdriver or similar fine-tipped implement before attaching the brackets.

For use when unit is installed horizontally or suspended:

Confirm that 4 built-in anti-vibration boards are set to position “H”.

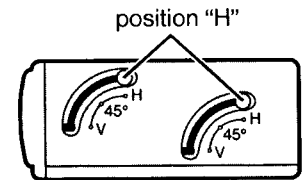

For use when unit is installed vertically:

4 built-in anti-vibration boards should be set to position “V”.

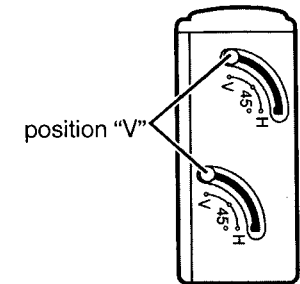

For use when unit is installed at a 45° angle:

4 built-in anti-vibration boards should be set to position “45°”.

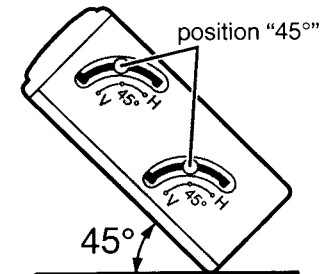

Caution

After setting the built-in anti-vibration boards, place the supplied seals (B) over the holes. These seals are used to keep dust, which could cause a malfunction, out of the unit.

WIRING

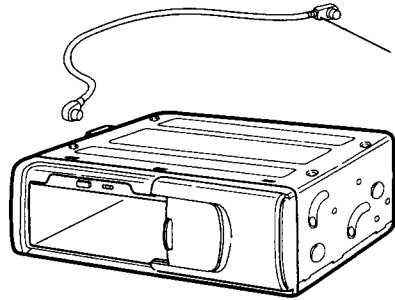

Connect this cable to the SANYO CD Changer Head units, CDM-100R, CDI-100R, CDM-200A, CDI-200A or FTP-CH1S.

INSTALLATION

Procedure for Installation on Carpet (Horizontal Position)

1

- Confirm that the built-in anti-vibration boards on both the left and right sides are set to the horizontal installation position "H".
- Attach bracket (L) and bracket (R) using the hexagonal bolts (M5 x 8).
- Attach brackets (L) and (R) to their respective brackets (B) using the hexagonal bolts (M6 x 20) and the hexagonal nuts (M6).

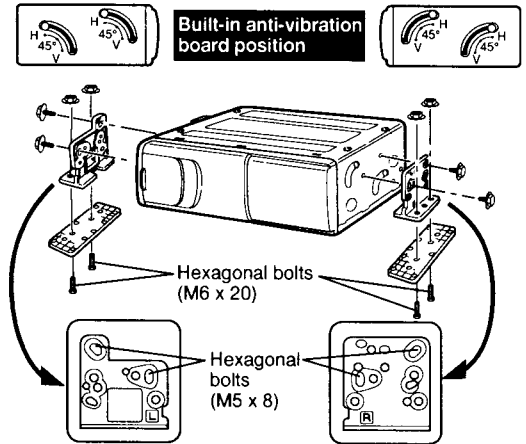

2

- Pull back the carpet and determine where to attach the unit.
- Stick the supplied double-sided tape to the bottom of the brackets (B) and peel off the paper backing.
- Affix the unit to the floor by pressing in place.

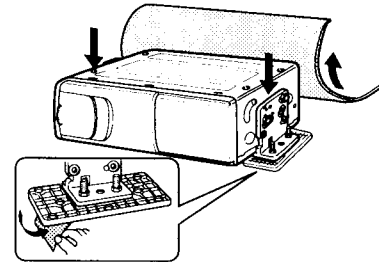

3

- Remove the hexagonal nuts and take off the changer.

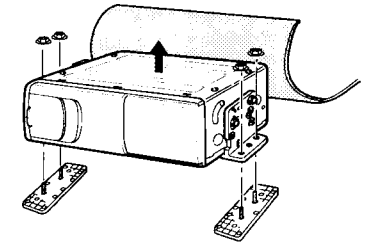

4

- Using a knife, cut "X"s in the carpet directly above the brackets (B) bolts.
- Return the carpet to its original position allowing the bolts to stick through.

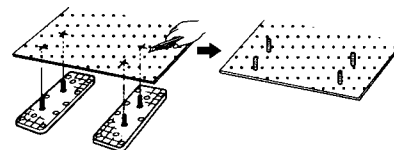

5

- Once more, use the hexagonal nuts to attach the changer on top of the carpet.

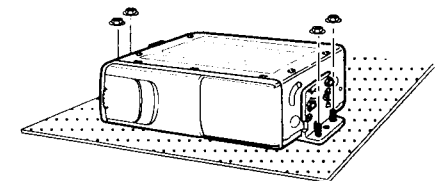

GB

Procedure for Installation on Carpet (Vertical Position)

1

- Set the built-in anti-vibration boards on both the left and right sides to the vertical installation position "V".
- Attach brackets (L) and (R) using the hexagonal bolts (M5 x 8).
- Attach brackets (L) and (R) to their respective brackets (B) using the hexagonal bolts (M6 x 20) and the hexagonal nuts (M6).

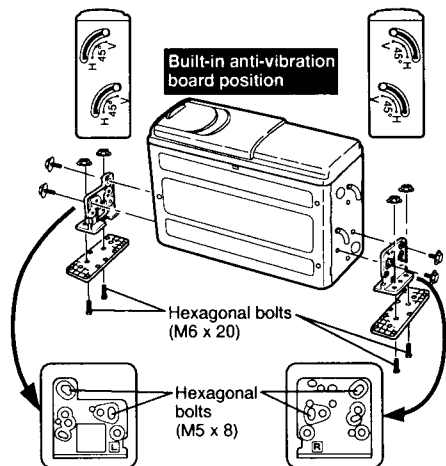

2

- Pull back the carpet and determine where to attach the unit.
- Stick the supplied double-sided tape to the bottom of the brackets (B) and peel off the paper backing.
- Affix the unit to the floor by pressing in place.

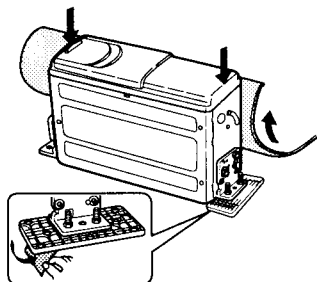

3

- Remove the hexagonal nuts and take off the changer.

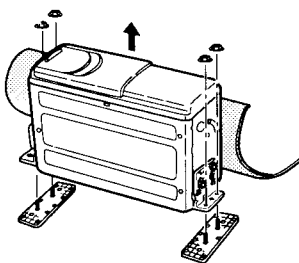

4

- Using a knife, cut "X"s in the carpet directly above the brackets (B) bolts.
- Return the carpet to its original position allowing the bolts to stick through.

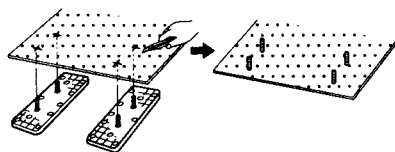

5

- Once more, use the hexagonal nuts to attach the changer on top of the carpet.

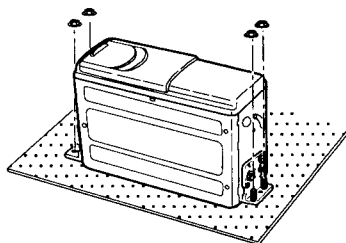

Procedure for Installation on Carpet (at a 45° angle)

1

- Set the built-in anti-vibration boards on both the left and right sides to the 45° installation position "45°".
- Attach brackets (L) and (R) using the hexagonal bolts (M5 x 8).
- Attach brackets (L) and (R) to their respective brackets (B) using the hexagonal bolts (M6 x 20) and the hexagonal nuts (M6).

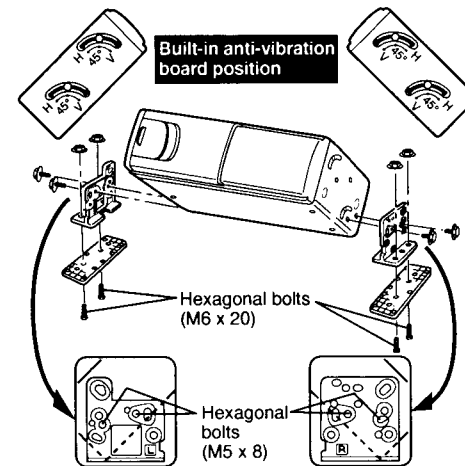

2

- Pull back the carpet and determine where to attach the unit.
- Stick the supplied double-sided tape to the bottom of the brackets (B) and peel off the paper backing.
- Affix the unit to the floor by pressing in place.

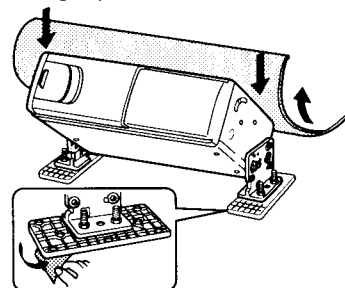

3

- Remove the hexagonal nuts and take off the changer.

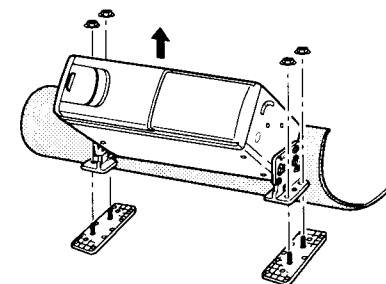

4

- Using a knife, cut "X"s in the carpet directly above the brackets (B) bolts.
- Return the carpet to its original position allowing the bolts to stick through.

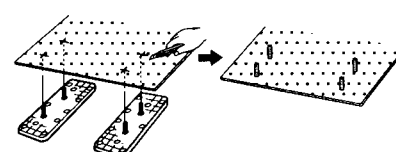

5

- Once more, use the hexagonal nuts to attach the changer on top of the carpet.

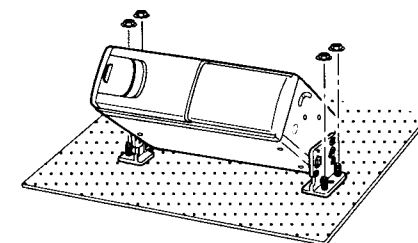

GB

Procedure for Installation (suspended position)

1

- Confirm that the built-in anti-vibration boards on both the left and right sides are set to the horizontal installation position "H".
- Attach bracket (L) and bracket (R) using the hexagonal bolts (M5 x 8).

2

- Determine the mounting location and drill four mounting holes.

3

- Attach the CD changer with the tapping screws (M5 x 12).

HANDLING THE DISCS

Dirt, dust, scratches and warpage cause sound skips during playback and a deterioration of sound quality. How to take care of your discs:



1. Use compact discs that have the mark shown on the right.
2. Fingerprints and dust should be carefully wiped off the disc's signal surface (glossy side) with a soft cloth. Unlike conventional records, the compact disc has no grooves to collect dust and microscopic debris, so gently wiping with a soft cloth should remove most particles. Wipe in a straight motion from the inside to the outside of the disc. Small dust particles or light stains will have absolutely no effect on reproduction quality.
3. Never use such chemicals as record sprays, antistatic sprays or fluid, benzine or thinner to clean compact discs. Such chemicals would irreparably damage the disc's plastic surface.
4. Discs should be put back in their cases after use to avoid serious scratches that could cause sound skip.
5. Do not expose discs to direct sunlight, high humidity, or high temperatures for extended periods of time. Long exposure to high temperatures can warp the disc.
6. Do not stick paper or write anything with a ball-point pen on the disc surface.

GB

TROUBLESHOOTING

An error made in operation or in the connections is sometimes mistaken for a failure or breakdown. Perform the checks described in the following table before calling in the servicing engineer.

Symptom	Cause	Remedy
No power	Improper connection.	Check connections.
Magazine cannot be installed.	Direction in which it is inserted is wrong.	Insert it in proper direction.
CD is not played.	Disc has been loaded upside down.	Load disc with play side facing up.
	The car battery is drained.	Charge the battery. If CD still is not played, consult with your dealer.
Noise is heard during playback or sound is intermittent.	Large scratches on disc or warped disc.	Compare sound with another disc. If sound from second disc is acceptable, first disc is defective.
	Extremely dirty disc.	Clean disc.
	Transit screws still in place.	Remove screws (x3) on bottom of unit and then use.
	Built-in anti-vibration board is installed in wrong direction.	Install board in proper direction. (Refer to "Installation" in Installation manual.)