

FXD-RS50

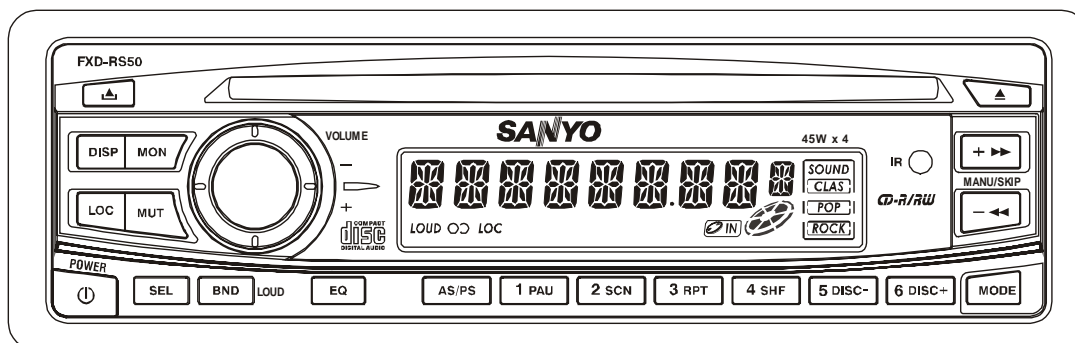

- Full Panel Detachable**
- High Power FM/MW/LW Stereo Receiver**
- Compact Disc Player**
- ISO Mounting with Removable Trim Ring**
- CD Changer Control**
- Remote Control**
- CD-R/RW Compatibility**

(English)

OPERATING INSTRUCTIONS..... 2~22

CONTENTS

COMPACT DISC CARE	3
DIGITAL DISPLAY	4
DETACHABLE FRONT PANEL	5
GENERAL OPERATION	6
RADIO OPERATION	8
CD OPERATION	10
CDC OPERATION	12
AUX MODE OPERATION	14
ERROR SIGNS	15
REMOTE CONTROL READY	16
HINTS FOR PROPER AND SAFE OPERATION	17
TROUBLE SHOOTING	18
ACCESSORIES AND HARDWARE	19
INSTALLATION	19





UNIT REMOVAL	20
ELECTRICAL CONNECTIONS.....	21
LINE OUT CONNECTIONS	22
AUXILIARY INPUT CONNECTIONS	22

CAUTION

- This unit is designed to operate on 12 volts DC, NEGATIVE ground electrical systems only.
- When fuse replacement is necessary, use only a 15 amp fuse. Do not replace with a higher rated fuse. If the fuse blows often, carefully check all electrical connections for any short circuits and have your car's voltage regulator checked also.
- Do not install the unit where it will be exposed to direct sunlight or hot air discharged from the car heater.
- Do not expose the unit to water or moisture.
- To avoid damaging the unit, never insert anything other than a compact disc into the disc slot.
- This unit should not be adjusted or repaired by anyone except qualified service personnel. If servicing is required, return the unit to an authorized SANYO mobile audio dealer.
- Use the Controls or adjustments or performance of procedures other than those specified herein may result in hazardous radiation exposure.
- Changes or modifications not expressly approved by SANYO may void the user's authority to operate this equipment.

COMPACT DISC CARE

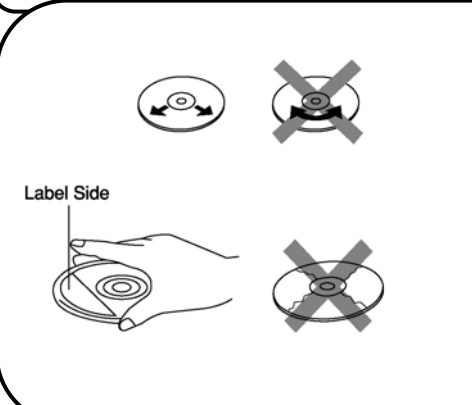
Dirt, dust, scratches and warpage can cause a deterioration in the sound or intermittent skipping some tracks during play.

	<ul style="list-style-type: none"> • This unit has been designed to play compact discs bearing the identification logo shown on the left. No other discs can be played.
	<ul style="list-style-type: none"> • Do not use non-conventional discs such as heart-shaped, octagonal discs, etc. The player could be damaged.
	<ul style="list-style-type: none"> • Fingerprints and dust should be carefully wiped off the signal surface of the disc (glossy side) with a soft cloth. Wipe in a straight motion from the inside to the outside of the disc. Unlike conventional records, the compact disc has no grooves to collect dust and debris. Small dust particles will have no effect on reproduction quality. • Do not insert a disc which is cracked into the unit. • Do not apply paper or write anything on the
	<ul style="list-style-type: none"> • To prevent warping the disc, do not expose it to direct sunlight, high humidity or high
 <p>Benzene Thinner Cleaning spray</p>	<ul style="list-style-type: none"> • Never use chemicals such as record cleaning sprays, antistatic sprays or fluids, benzene or thinner to clean compact discs. These chemicals will permanently damage the plastic surface of the disc. • When not using the disc player for extended periods of time, remove the compact disc and return it to the plastic storage case. This will protect the disc from dust and exposure to

Recommended CD-R/RW Media

Data may not be properly written to CD-R/RW media depending on the quality of the media. If this happens, the data may not be reproduced correctly. We recommend the following manufacturers to insure proper quality of the media.

CD-R Media

TDK USA Corp., Taiyo Yuden (U.S.A.), Inc., Ricoh Corporation, Eastman Kodak Company, Maxell Corporation of America, Mitsubishi Chemical Corporation, Fuji Photo Film U.S.A., Inc., Mitsui Chemicals, Inc., Sony Corporation of America, Philips Electronics North America Corporation, Imation Corp.

CD-RW Media

TDK USA Corp., Ricoh Corporation, Mitsubishi Chemical Corporation.

Additionally, CD-R media compatible with various speeds such as 2X and 1X-4X are available. Please refer to the instruction manuals of the drive and the recording software you are using to selection of the correct media.

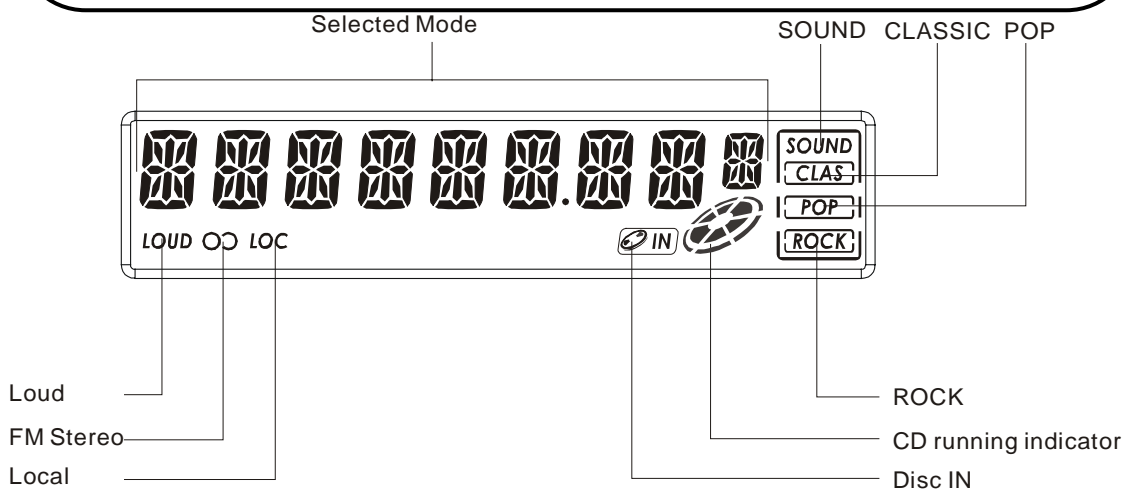

DETACHABLE FRONT PANEL

The front panel is designed to be removable for antitheft purposes. It is recommended that you remove and carry the front panel with you when you leave your car.

HOW TO ATTACH THE FRONT PANEL

Align the right side of the panel (A) with the stopper (B), and then push the left side of the panel into the unit until it clicks.

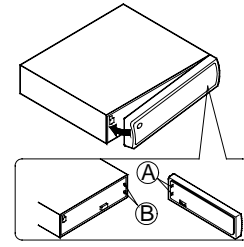

HOW TO DETACH THE FRONT PANEL

Press the release button (▲) to release the front panel. Pull the entire panel to remove it from the unit.

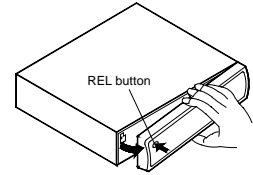

RETURNING TO THE INITIAL SETTINGS

When the front panel is detached, you can find the **RESET** button on the front side of the unit. Press the button, the Microcomputer of the unit returns to the initial settings. If the display window is not properly shown or the unit malfunctions, press the **RESET** button.

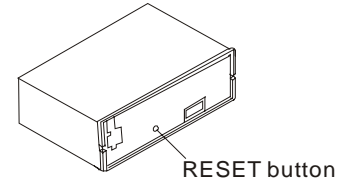

Note

The unit will not operate if panel is installed incorrectly.

⚠ CAUTION

- Do not attempt to remove the panel in a manner other than that described above.
- When installing the panel, do not force it into the unit.
- Do not touch the connection terminals of the panel or the unit. It may cause poor contact.
- Use a clean, dry cloth when cleaning the terminals.
- Keep the panel out of direct sunlight and high temperatures.
- Prevent the panel from coming into contact with benzene, thinner, or insecticides.
- Do not drop the panel.

GENERAL OPERATION

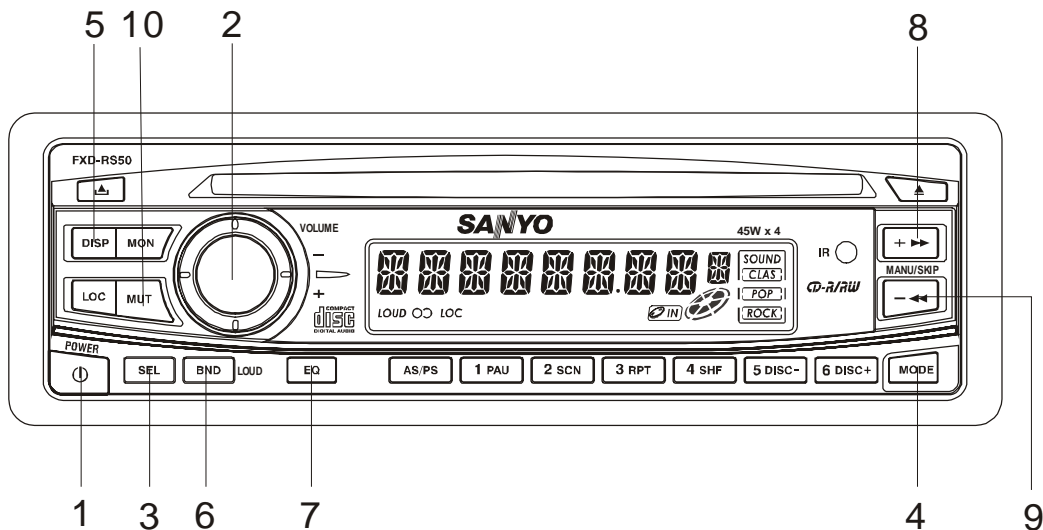

TURNING THE POWER ON.....Any button

Install the front panel and press any button (except ▲ and ▴ button) when ACC is on.

TURNING THE POWER OFF (1)

When system is on, press the **POWER** button (1) to turn off the unit.

VOLUME LEVEL CONTROL.....(2)

Rotate the **VOLUME** dial (2) to adjust the volume level.

ADJUSTING THE SOUND

CHARACTERISTICS(2), (3)

Press the **SEL** button (3) shortly:

1. Each time you press the **SEL** button (3) shortly, the item changes as follows;



2. Rotate the **VOLUME** dial (2) to adjust the selected item. Make the adjustment within 5 seconds after selecting. After 5 seconds, the display window will revert to display priority.

Adjustment Range

BASS (BAS 00)	BAS -10	BAS 10
TREBLE (TRB 00)	TRB -10	TRB 10
BALANCE (BAL L=R)	10L	10R
FADER (FAD F=R)	10F	10R

Beep Sound Adjustment:

Press and hold the **SEL** button (3) for several seconds enter beep sound adjustment mode, then rotate the **VOLUME** dial (2) clockwise or counter-clockwise to select as follows:



- BEEP 2ND mode:
The beep is only generated when all allowed double function button is pressed for several seconds.

e.g.
When preset button is pressed.
When **BND/LOUD** button is pressed.
When **AS/PS** button is pressed.
- BEEP ALL mode:
The beep is generated when every button is pressed.
- BEEP OFF mode:
The beep is disabled.

MODE SELECTION.....(4)

Press **MODE** button (4) to choose desired listening mode. (e.g. radio mode to CD mode.)

SET THE CLOCK.....(5),(8),(9)

Press the **DISP** button (5), the clock is shown on the LCD display. Then hold down the button until the clock flashes. Then press the **MANU/SKIP + ►►** button (8) to change hours or **MANU/SKIP - ◀◀** button (9) to change minutes.

LOUDNESS EFFECT.....(6)

Press **BND/LOUD** button (6) for several seconds to reinforce the bass output. Press it for several seconds again to release this function.

EQUALIZATION.....(7)

Press **EQ** button (7) to turn on equalization function and to select desired audio mode. There are five kinds of modes as below:

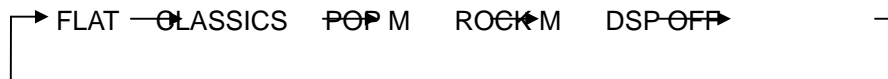

MUTE FUNCTION.....(10)

Press **MUT** button (10) to mute down the sound instantly. If any button is pressed in the mute state, the mute state is released.

RADIO OPERATION

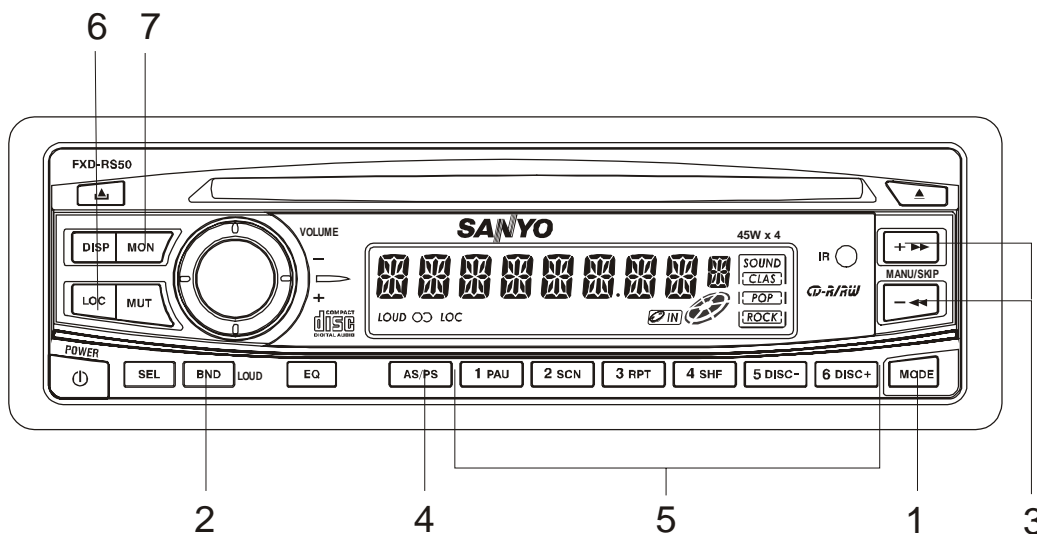

SWITCHING TO RADIO MODE.....(1)

Press **MODE** button (1) to select radio mode, the radio mode appears in the display together with the memory band and frequency.

SELECTING THE FREQUENCY BAND.....(2)

At radio mode, press **BND/LOUD** button (2) quickly to select the desired band.

The band will change in the following order:

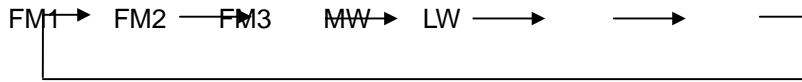

RADIO TUNING.....(3)

Press the **MANU/SKIP** + **▶▶** or **◀◀** button (3) shortly to activate automatic seek function. Press for several seconds until "MANUAL" appears on the display, the manual tuning mode is selected. If both buttons have not been pressed for several seconds, they will return to seek tuning mode and "AUTO" appears on the display.

AUTOMATIC MEMORY

STORING & PROGRAM SCANNING.....(4)

- Automatic memory storing
Press **AS/PS** button (4) for several seconds, the radio searches for the six strongest stations and stores them into the presets of the currently selected band. While searching, "LOC" appears on the display.
- Program scanning
Press **AS/PS** button (4) shortly to scan preset station in memory.

STORING PRESET STATIONS(5)

The preset buttons (5) can be used to store 6 stations in each band (FM 1, FM 2, FM 3 and MW, LW) for convenient access to your favorite stations.

- Programming stations
 1. Select the desired band, then tune in the station you want to store in memory.
 2. Press and hold one of the preset buttons (5) for more than 2 seconds until the corresponding preset button number appears. Repeat steps 1. and 2. to program additional stations.
- Quick tuning Select the desired band, then press one of the six preset buttons (5).

LOCAL/DISTANT SELECTION(6)

Press **LOC** button (6) to set local or distant stations.

Use local position (LOC appear on the display) for reception of strong station, and distant position (DX appears on the display) for reception of weaker stations. This function is effective during AUTO SEEK operation.

MONO/STEREO.....(7)

Press **MON** button (7) to select mono or stereo mode. You can sometimes improve reception of distant stations by selecting mono operation..

CD OPERATION

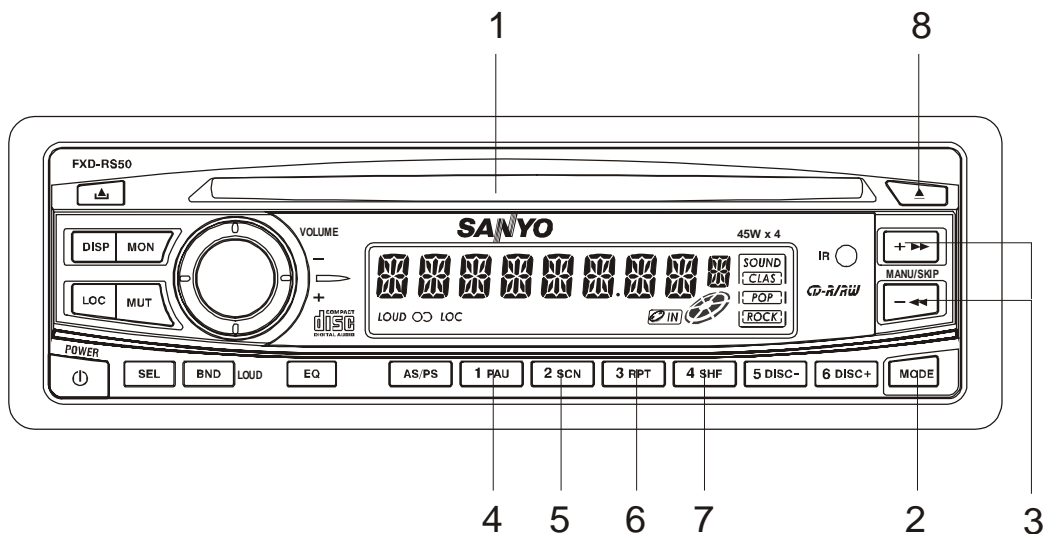

LOADING AND EJECTING THE CD.....(1),(8)

Insert a disc into the CD slot (1) and the CD player will start.
The system remains in CD mode and “ IN ” appears in the display.
Press the eject button (8) to eject a disc.

SWITCHING TO CD MODE.....(2)

Press the **MODE** button (2) with the power on to switch from radio mode or CDC mode or AUX mode to CD mode.
When the entire disc has played, the unit returns to the first track and play resumes.

SKIPPING TRACKS(3)

Press the **MANU/SKIP** + ►► button to skip to the beginning of the next track.
Press the **MANU/SKIP** - ◄◄ button to skip to the beginning of the previous track.
Press and hold the **MANU/SKIP** + ►► or **MANU/SKIP** - ◄◄ (3) for several seconds to search quickly (with sound) in the forward or reverse direction.
When the button is released, the CD resumes normal play.

Notes:

- Some CD-Rs/CD-RWs (depending on the equipment used for its recording or the condition of the disc) may not play on this unit.
- You cannot play CD-R/CD-RW that is not finalized. (A finalize process necessary for a recorded CD-R disc to be played on the audio CD player.)

PLACING THE CD IN PAUSE MODE (4)

While playing a CD, press the **PAU** button (4).
To resume playing, press the **PAU** button (4) again.

Notes

- During playback of a CD, the CD running indicator  spins.
- The unit will turn-on automatically when a CD is inserted if the ignition switch is "ON".

OF EACH TRACK) (5)

This function plays the first several seconds of each track sequentially.

Press the **SCN** button (5) to begin the scan mode.

To cancel this mode, press the **SCN** button (5) again.

REPEAT MODE (6)

Press the **RPT** button (6) to play the current track repeatedly.

To cancel this mode, press the **RPT** button (6) again.

SHUFFLE MODE..... (7)

This function plays the tracks on a CD in random order.

Press the **SHF** button (7) to begin shuffle play.

To cancel this mode, press the **SHF** button (7) again.

CD CHANGER OPERATION

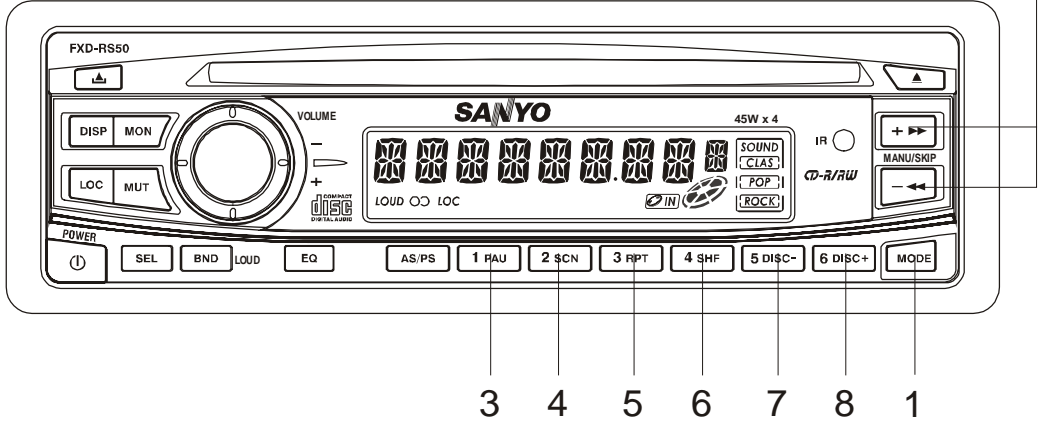

SWITCHING TO CD CHANGER (CDC) MODE.....(1)

Press the **MODE** button (1) with the power on to select CDC mode. When the CDC mode is switched on, playback begins with the first CD that the CD changer detects. (Note: Unit will only go to CDC mode if the SANYO CD changer is connected.)

SKIPPING TRACKS(2)

Press the **MANU/SKIP +>>** to skip to the beginning of the next track. Press the **MANU/SKIP <<-** button to skip to the beginning of the previous track. Press and hold the **MANU/SKIP +>>** or **MANU/SKIP <<-** button (2) for several seconds to search quickly (with sound) in the forward or reverse direction. When the button is released, the CD resumes normal play.

PLACING THE CD IN PAUSE MODE (3)

While playing a CD, press the **PAU** button (3). To resume playing, press the **PAU** button (3) again.

SCAN MODE (PLAYING THE BEGINNING OF TRACKS OR DISCS) (4)

This function plays the first several seconds of each track or disc sequentially.

- Playing the beginning of tracks (Track Scan)
Press the **SCN** button (4) to play the first several seconds of each track on the current disc in order.
- Playing the beginning of disc (Disc Scan)
Press and hold the **SCN** button (4) for several seconds to play the first several seconds of each disc in the magazine.

To cancel the track scan or disc scan mode, press **SCN** button (4) again.

REPEAT MODE(5)

- Repeat tracks
Press the **RPT** button (5) to play the current track repeatedly.
- Repeat discs
Press and hold the **RPT** button (5) for several seconds to play the current disc repeatedly.

To cancel the track repeat or disc repeat mode, press the **RPT** button (5) again.

SHUFFLE MODE..... (6)

This function plays the tracks on one CD or all CDs in the magazine in random order.

- "Shuffle-playing" tracks
Press the **SHF** button (6) to play the current disc in random order.
- "Shuffle-playing" discs
Press and hold the **SHF** button (6) for several seconds. The system selects a disc at random and plays all tracks on that disc. When all tracks have been played, the next disc is selected and "Shuffle-playing" is repeated.

To cancel the track shuffle or disc shuffle mode, press the **SHF** button (6) again.

SELECTING A DISC..... (7),(8)

Press the **DISC-** button (7) to select the preceding disc.

Press the **DISC+** button (8) to select the next disc.

Note

- Use with only SANYO CD Changer.

AUX MODE OPERATION

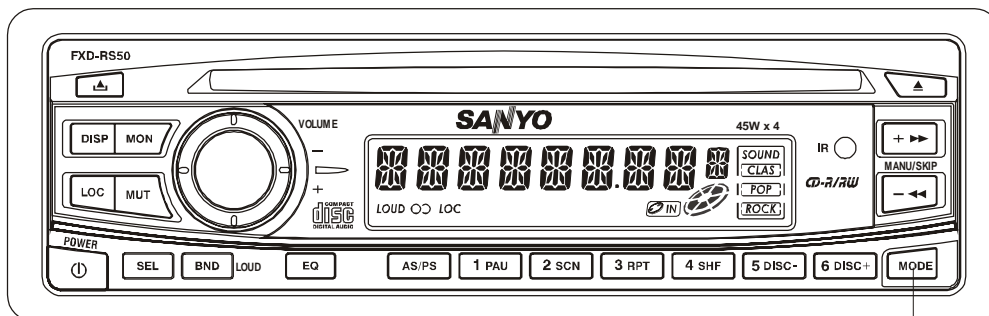

1

SWITCHING TO AUX MODE.....(1)

The unit has a pair of auxiliary input terminals (see WIRING figure on page 21). This allows you to listen to an auxiliary audio source (MP3, portable cassette player, etc).

Press the **MODE** button (1) with the power on to switch from radio mode or CD mode or CDC mode to AUX mode.

ERROR SIGNS

If a problem should occur while operating the CD player, one of the following error signs may be displayed. Refer to the table below to identify the problem.

DISPLAY	DESCRIPTION
ERROR 1	MECHANISM ERROR
ERROR 2	SERVO ERROR

If a problem should occur while operating the CD CHANGER player, one of the following error signs may be displayed. Refer to the table below to identify the problem.

DISPLAY	DESCRIPTION
ERROR 1	MAGAZINE or MECHANISM ERROR
ERROR 2	EJECT ERROR
ERROR 3	LOADING ERROR
ERROR 4	UNLOADING ERROR
ERROR 5	ELEVATOR ERROR
ERROR 6	SLED or SLED SWITCH ERROR
ERROR 7	FOCUSING or DISC DATA READ ERROR
ERROR 8	CLV or DATA READ ERROR
ERROR 9	TOC READ ERROR
ERROR 10	THERMAL ERROR

REMOTE CONTROL

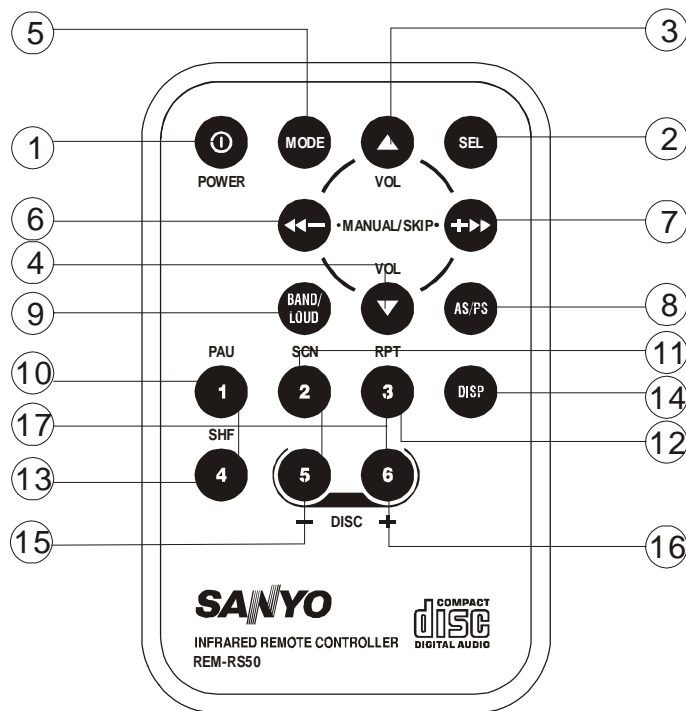

- | | |
|-------------------|------------------------|
| 1. POWER | 10. PAU |
| 2. SEL | 11. SCN |
| 3. VOL ▲ | 12. RPT |
| 4. VOL ▼ | 13. SHF |
| 5. MODE | 14. DISP |
| 6. MANUAL/SKIP ◀▶ | 15. DISC+ |
| 7. MANUAL/SKIP ▶▶ | 16. DISC- |
| 8. AS/PS | 17. 1-6 Preset buttons |
| 9. BAND/LOUD | |

REMOTE SENSINGIR

Point the remote control handset to the remote sensor IR. Press the function keys on the handset to control the system.

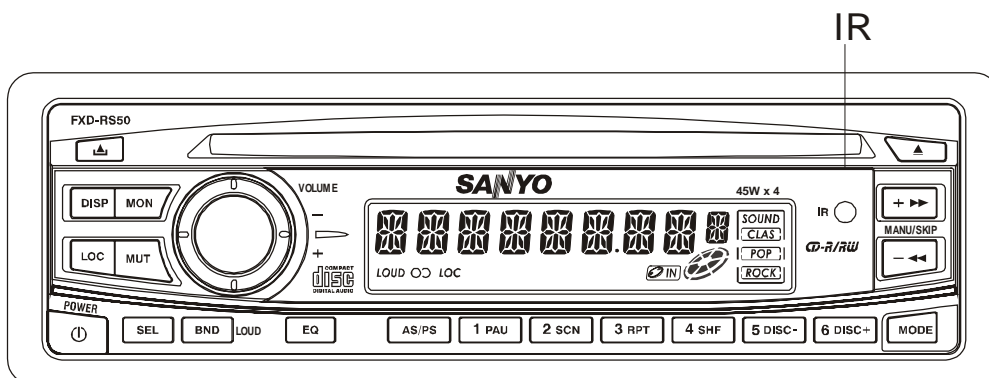

HINTS FOR PROPER AND SAFE OPERATION

- **Condensation**

Moisture can condense on the optical lens of the CD player during humid or rainy days, or after the car heater is turned on. If this occurs the disc player may not function properly. To remedy the situation, remove the disc from the unit and wait approximately one hour. This should allow the moisture to evaporate and restore normal operation.

- **Temperature Consideration**

The unit may not operate correctly in extremely hot or cold temperatures. Avoid exposing the unit to extremely high or low temperatures.

- **Interruptions in the sound (skipping)**

When the car is driven on very rough surfaces, the sound from the CD player may skip and be interrupted. This will not cause any damage to the disc or the player. If this occurs, wait for the road surface to improve before using the CD player.

- **Safety**

For safer driving, keep the volume at a moderate level to enable you to hear outside sounds (such as emergency vehicle sirens).

- **Cleaning the unit**

Clean the unit with a soft, dry cloth. Stains should be removed by wiping the surfaces with a soft cloth immersed in lukewarm water and wrung dry. Never use strong chemicals or solvents. These will damage the finish of the unit.

- **Disc care**

When not using the disc player for extended periods, remove the compact disc and return it to the plastic storage case. Do not leave a disc partially ejected from the player. If an ejected disc remains in the loading slot for approximately 10 seconds, the player will reload the disc to prevent damage.

- **Servicing**

Should a problem develop, do not open the unit or try to repair it yourself. If servicing is required, bring the unit to a Sanyo Authorized Service Center.

TROUBLE SHOOTING

Sometimes a simple operational error or a mistake in the wiring can appear to be a problem with the unit. Before having the unit serviced, refer to the troubleshooting chart below.

Symptom	Cause	Solution
The compact disc does not play when inserted into the unit.	The volume control is turned down.	Turn up the volume control.
	The power connections are not wired correctly.	Check the +12V and ground connections.
No power.	The vehicle ignition is switched off.	Switch the ignition to the "ON" or "ACC" position.

	The fuse is blown.	Replace the fuse with another 15A fuse.
The unit does not work properly (Eject, Load, Play)	The microcomputer has been affected by electrical noise.	Press RESET button.
The sound from the CD player skips.	The road surface is rough.	Wait for the road surface to improve before playing a disc.
	The unit is not mounted securely.	Install the unit securely. Be sure to use the rear strap if the vehicle does not provide support for the rear of the unit. (See page 20)
	The disc is defective.	Try another disc. If it plays properly, the first disc may be defective.
	The disc is dirty.	Clean the disc as explained on page 3.
No radio reception.	The antenna cable is not connected.	Insert the antenna cable firmly into the antenna jack on the unit.
The radio does not stop on any stations when automatic tuning is used.	The signals are weak.	Select a station using manual tuning.

ACCESSORIES AND HARDWARE

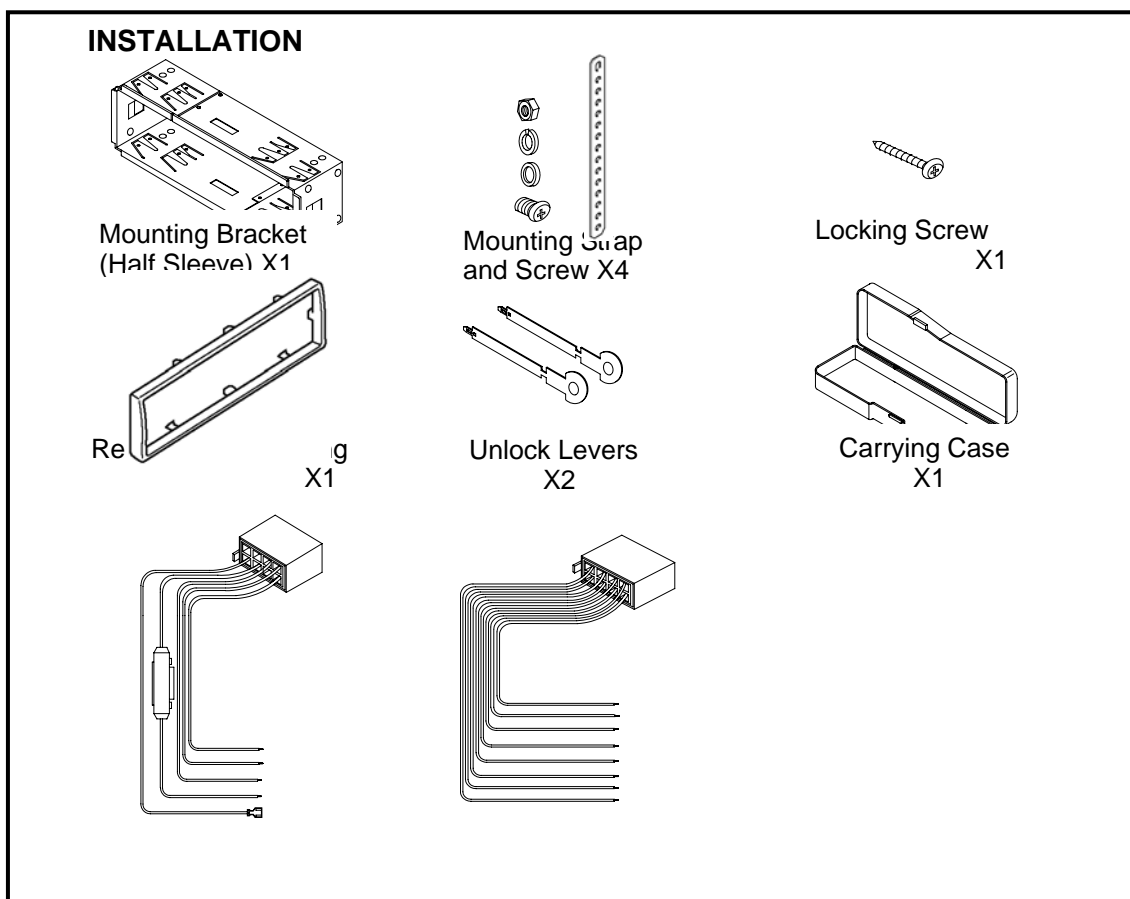

INSTALLATION

1. BEFORE INSTALLATION

When mounting the unit in a car, keep the unit as level as possible.

If the unit must be mounted at an angle, due to the design of the vehicle, make sure the unit does not tilt by more than 30°.

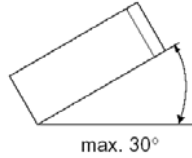

2. INSTALLATION PROCEDURES

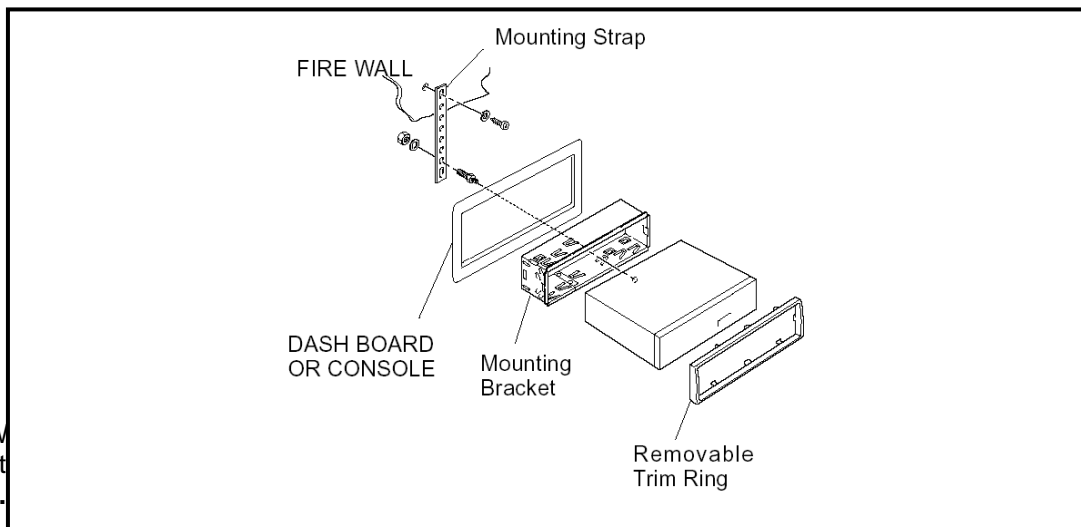

W
at
1.

2. Bend the mounting bracket stopper outward until the bracket fits snugly in the cutout.
3. Attaching the Mounting Strap to the underside of the dashboard, using screw. Attach the back of the unit to the Mounting Strap using support stem bolt and hardware.

UNIT REMOVAL

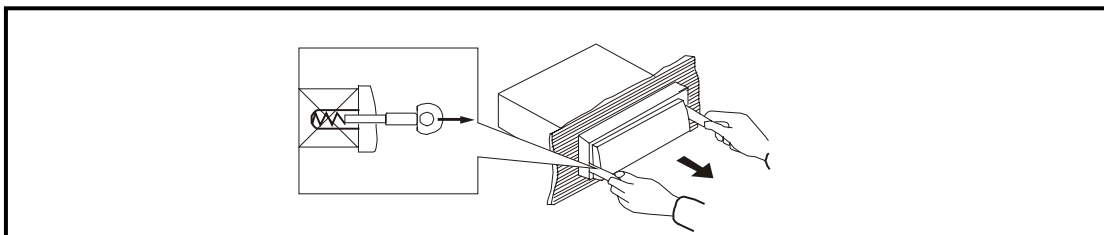

2. Pull on the levers to remove the unit.

Notes

- Handle the unlock levers carefully to avoid injuring your fingers.
- Keep the unlock levers in a safe place for future use.

ELECTRICAL CONNECTIONS

WIRING

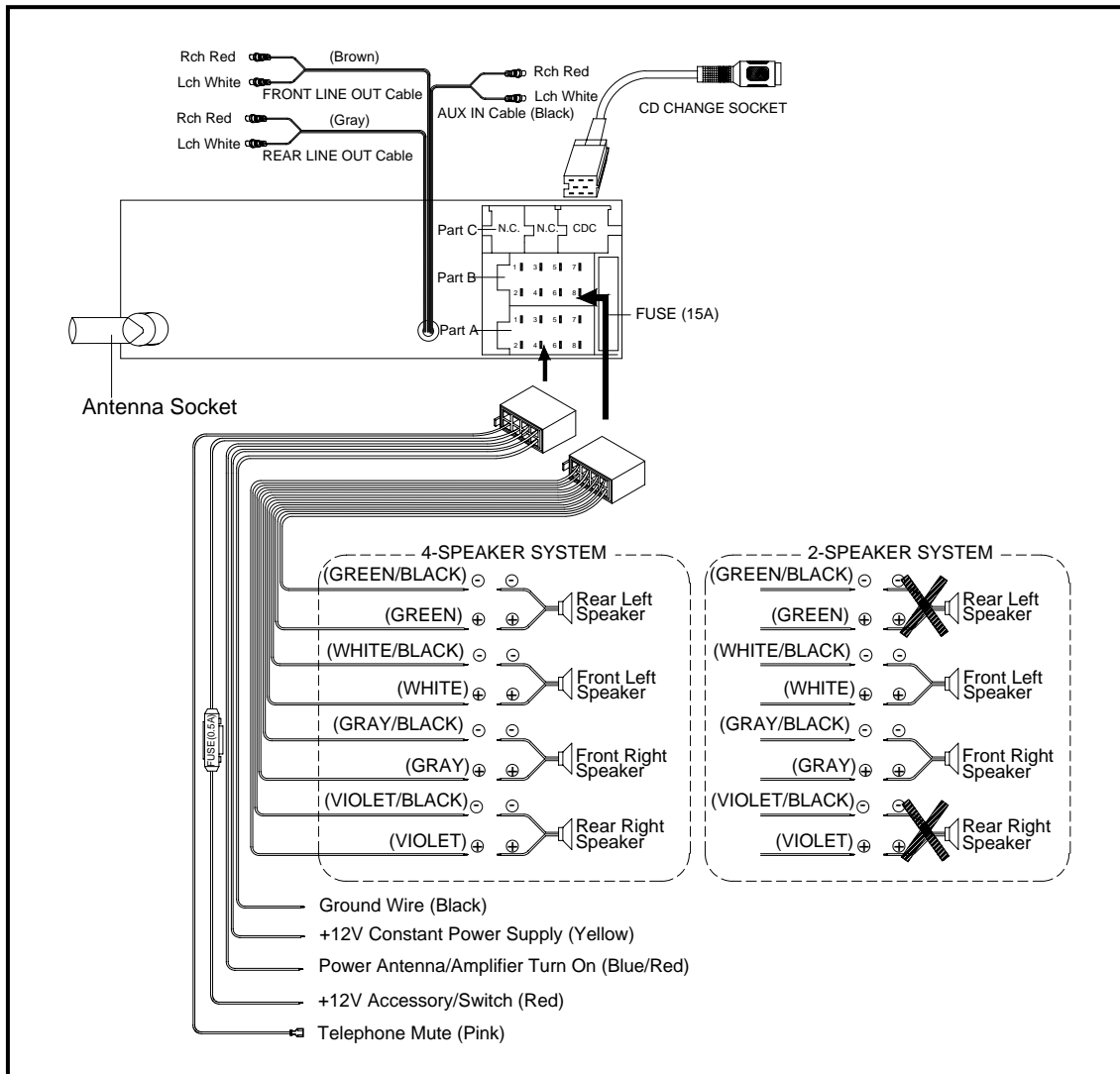

- **DO NOT** connect any speaker wires to the metal body or chassis of the vehicle.
- **DO NOT** connect the speaker common (–) wires to each other.
- Connect each speaker wire directly to each speaker terminal.
- All speaker common (–) wires must remain floating.

1. **Antenna Socket**
 • Insert the plug from the antenna installed in your vehicle into this socket. (If your vehicle has a dual antenna system, a dual antenna to single antenna cable adaptor may be required.)

2 + 12V Constant Power Supply (Yellow)

• Connect this wire to the +12V power terminal which receives power continuously.

3 +12V Accessory/Switched (Red)

• Connect this wire to the terminal which receives power while the ignition switch is ON or in the ACCESSORY position.

• If the ignition switch does not have an ACC position, connect this wire to a +12V power terminal which receives power continuously. (Same as item 2.)

4 Ground Wire (Black)

• Connect this wire to the vehicle chassis.

5 Power Antenna/Amplifier Turn On (Blue/Red)

- Connect this wire to the control terminal of a Power Antenna or an external amplifier.
- When not using a Power Antenna or an external amplifier, this wire is not connected.

6 Telephone Mute (Pink)

- Connect this wire to the control terminal of a Telephone Mute.
- Sound is muted at low level. When not using Telephone Mute, this wire is not connected.

7. CD Changer Socket

- Connect a CD changer to the CD changer socket

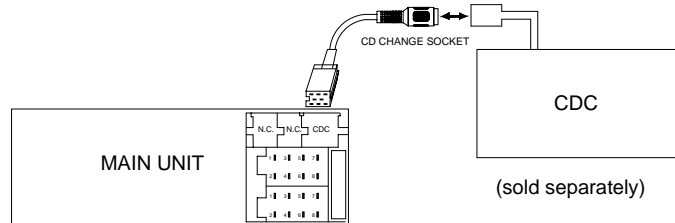

REPLACING THE FUSE

When fuse replacement is necessary remove the blown fuse by using pliers. Then install the new 15 amp. fuse.

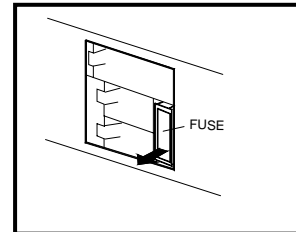

LINE OUT CONNECTIONS

- The unit has two pairs of line out terminals (see WIRING figure above). You can use a separate front or a separate rear channel amplifier to upgrade your system.

RCA Line- out Jacks

- Connect a patch cable (not supplied) from the White (left channel) and Red (right channel) RCA line output jacks to the line input terminals of the external amplifier.

AUXILIARY INPUT CONNECTIONS

The unit has a pair of auxiliary input terminals. You can connect a portable audio player through the terminals of the AUX IN cable (see WIRING figure above).



FXD-RS50. Issue Number 1.

Printed in Hong Kong

88-C1980-30