

SANYO

OPERATING INSTRUCTIONS LIBRITO DE INSTRUCCIONES

使用説明書

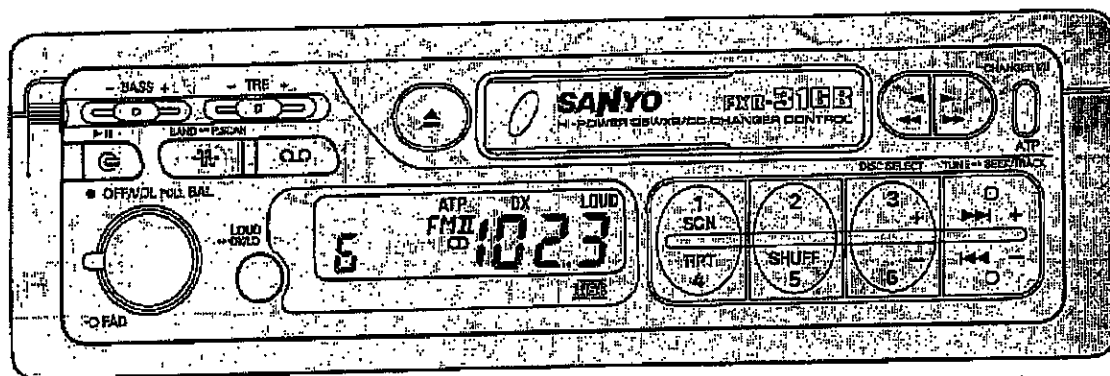

FXR-31GB.

Full Auto Reverse Car Fidelity Receiver/ Cassette Player

English	4 ~ 13
Español	14 ~ 24
中國語	25 ~ 34

FXR-31GB

ELECTRICAL CONNECTIONS

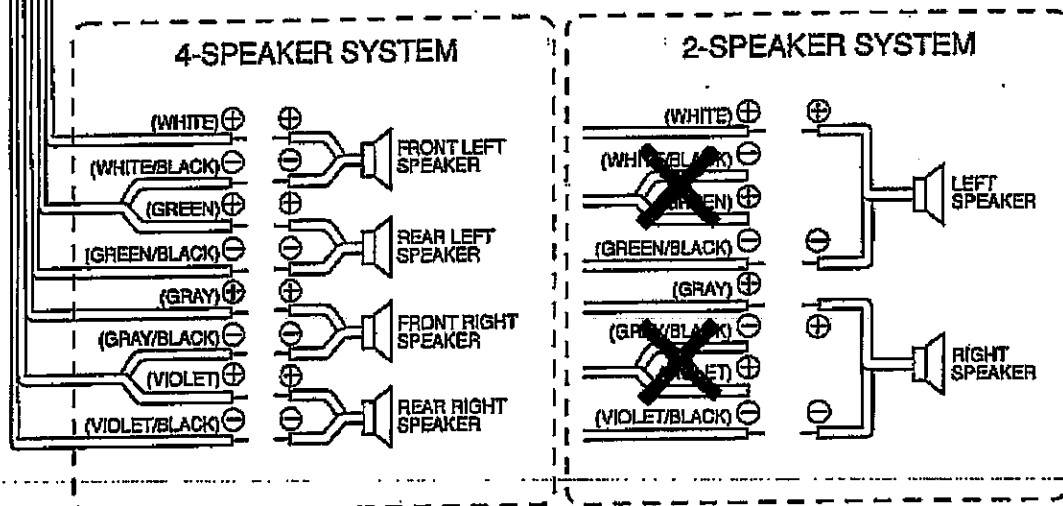
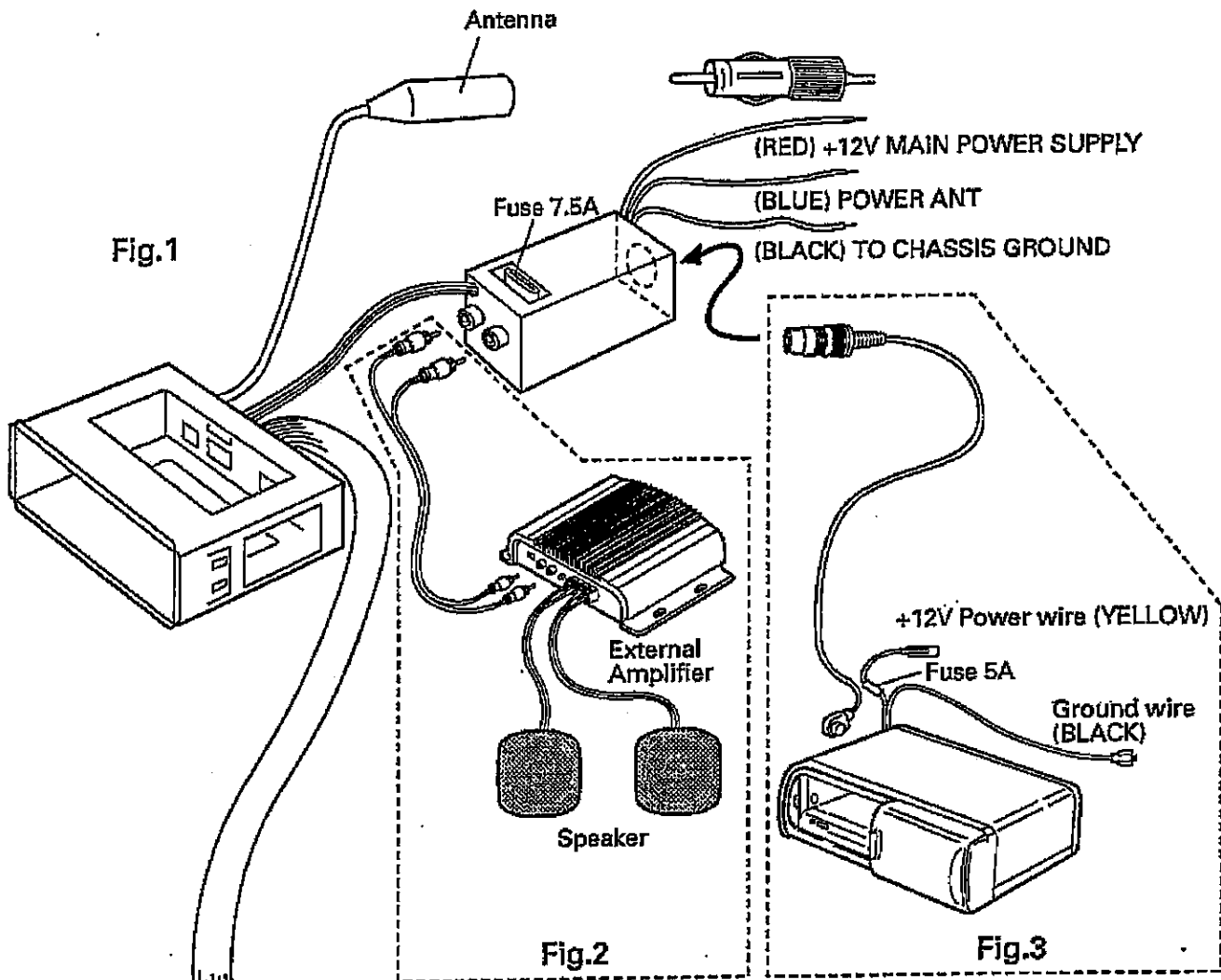

Fig. 4 Not connecting the white/black, green, gray/black and violet.

LOCATION OF CONTROLS (TAPE & RADIO OPERATION)

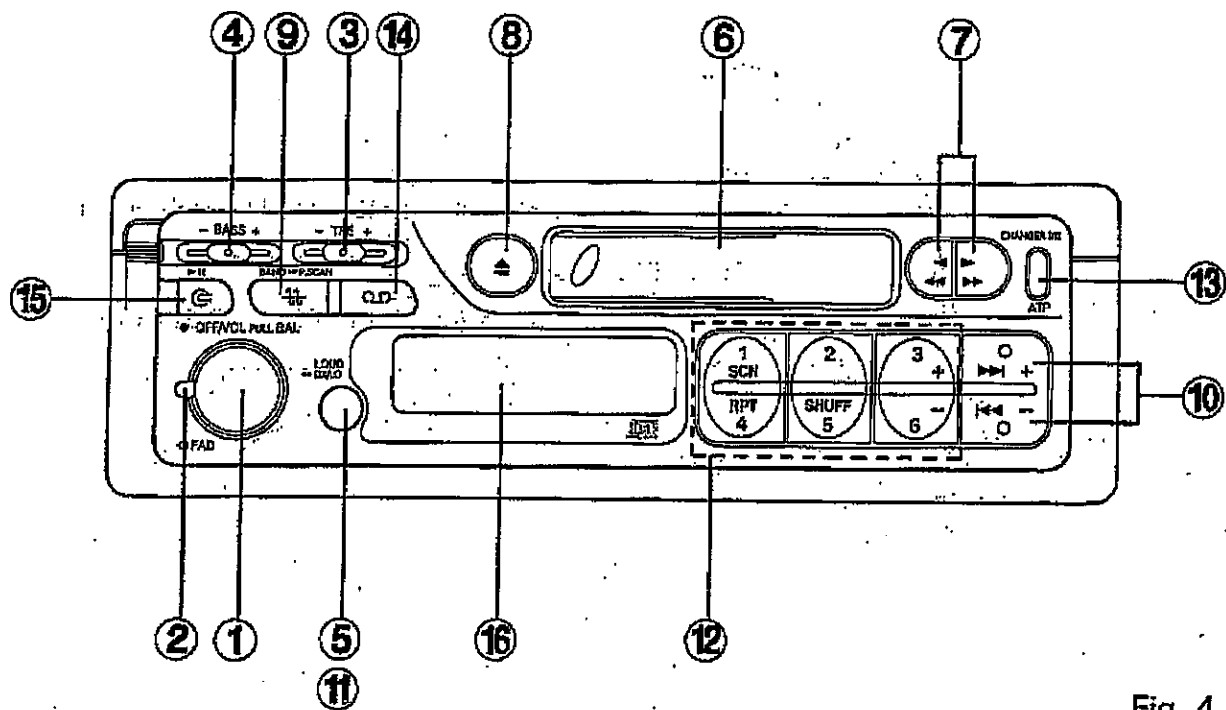

Fig. 4

DIGITAL DISPLAY

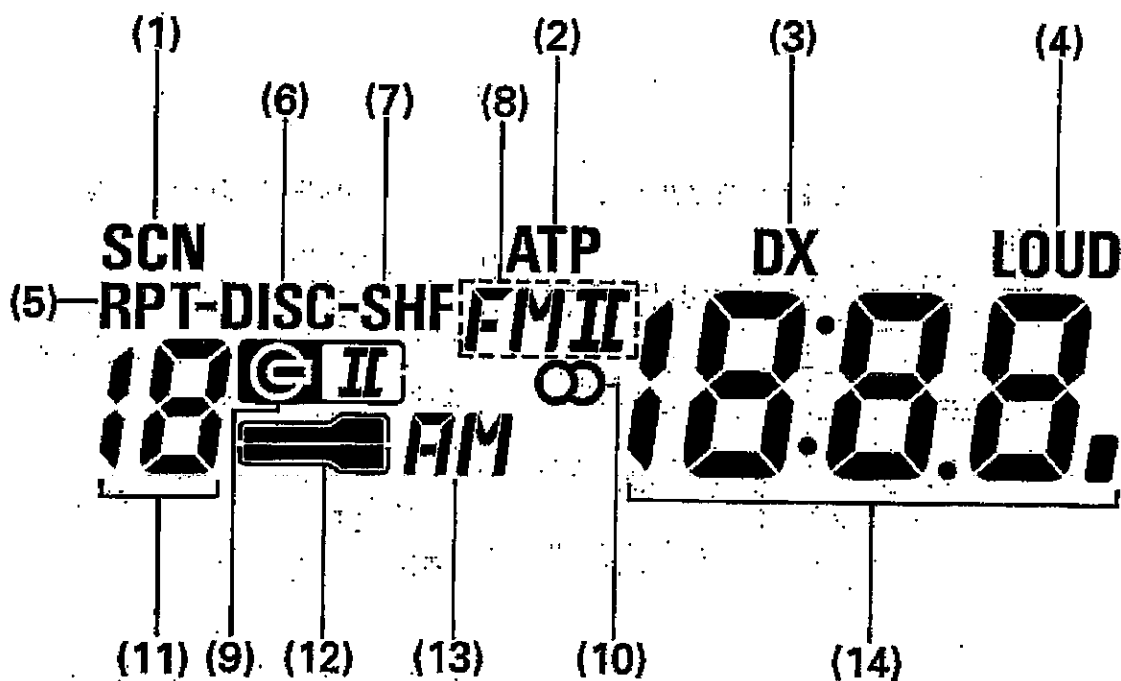

Fig. 5

INSTALLATION

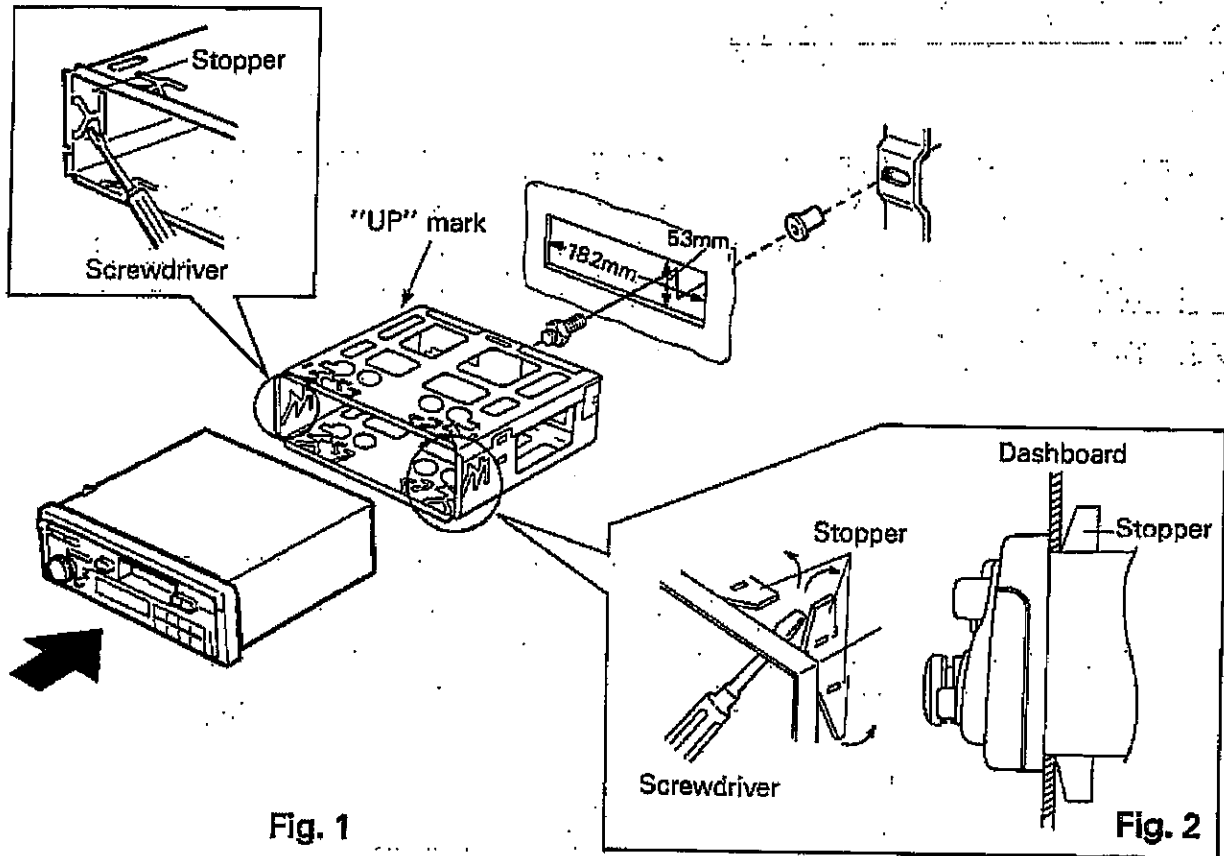
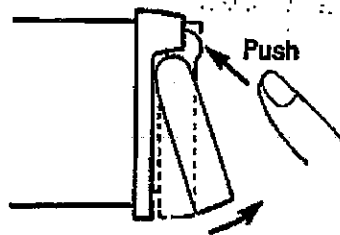

Fig. 1

Fig. 2

UNIT REMOVAL

1. Push the elevated area on the left upper side of the handle. The handle will rise.
2. Pull the handle to remove the unit.



Thank you for purchasing SANYO's FXR-31GB cassette car stereo player. For proper operation and performance, read this instruction manual carefully.

WARNING

1. This unit is designed to operate on 12 volts DC, NEGATIVE ground electrical systems only.
2. When fuse replacement is necessary, use only a 7.5 A fuse. Do not replace with a higher rated fuse. If the fuse blows often, carefully check all electrical connections for any short and have your car's voltage regulator checked too. Do not attempt to repair the unit by yourself; return the unit for servicing to your nearest SANYO car audio dealer.
3. The high-polished playback head should not be touched by any metallic or magnetic tools.
4. If noise is a problem . . .
This unit incorporates a noise filter in the power circuit. However, with some vehicles, some clicking or other unwanted noise may still be present. In such a case, consult a SANYO car audio dealer or radio installer.
5. Never play dirty or dusty tapes because it greatly degrades the sound and performance of your unit. Therefore always keep your tapes clean.
6. Do not use tapes with wrinkled or half-peeled labels to avoid possible system trouble.

When inserting a cassette be sure that the tape is not unraveled from its spool. If a cassette is inserted in this condition the tape may wrap around the capstan and damage the tape and/or the mechanism. Use a pencil or a small rod as shown to keep tape tight in the cartridge.

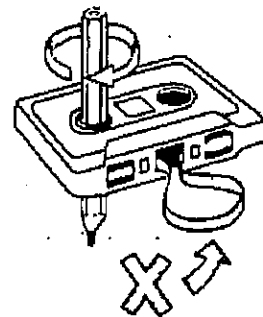







OPERATION

- ① Power switch, Volume control and Balance control (OFF/VOL FULL BAL)
- ② Fader control knob (FAD), Line out Level control
- ③ Treble control knob (TRE)
- ④ Bass control knob (BASS)
- ⑤ Loudness knob (LOUD)
- ⑥ Cassette tape slot door
- ⑦ Fast Forward, Fast Rewind button (◀◀, ▶▶), Reverse button (◀▶)
- ⑧ Eject button (▲)
- ⑨ Radio mode select button (Ⓜ), Band button (BAND), Preset Scan button (PSCAN)
- ⑩ Seek & Manual tuning button (▶▶|+, |◀◀-)
- ⑪ Distant/Local button (DX/LO)
- ⑫ Preset button (1·2·3·4·5·6)
- ⑬ Auto-Travel Preset button (ATP)
- ⑭ Tape mode select button (ⓐ)
- ⑮ CD mode select button (ⓐ)
- ⑯ Digital display









DIGITAL DISPLAY

- | | |
|---|---|
| (1) Scan indicator (SCN) | (9) CD changer No. indicator
(ⓐ I, ⓐ II) |
| (2) Auto-Travel Present indicator (ATP) | (10) Stereo Signal indicator (∞) |
| (3) DX indicator (DX) | (11) Disc/Channel Number indicator |
| (4) Loudness indicator (LOUD) | (12) Tape running indicator (■) |
| (5) Repeat indicator (RPT) | (13) AM band indicator (AM) |
| (6) Disc indicator (DISC) | (14) Track and Frequency indicator |
| (7) Shuffle indicator (SHF) | |
| (8) FM band indicator (FM I, FM II) | |

COMMON FUNCTION

- **Power switch, Volume and Balance control knob (OFF/VOL PULL BAL) . . . ①**
Turn the knob clockwise to switch ON and set listening level. Balance of Right and Left channel level is controlled in pull position.
- **Fader control (FAD) . . . ②**
Turn clockwise to increase Rear volume, counter clockwise to increase Front volume.
- **Treble control (TRE) . . . ③**
By moving this knob to the right, the higher frequencies are emphasized.
- **Bass control (BASS) . . . ④**
By moving this knob to the right, the lower frequencies are emphasized.
- **Loudness button (LOUD) . . . ⑤**
By pressing the Loudness switch the bass and treble range are emphasized at low listening level.
- **Mode Select button(s) ( ,  , ) . . . ⑮ ⑨ ⑭**
It is possible to switch immediately to your desired mode by pressing any of these Mode Select buttons (CD mode  , radio mode  , tape mode ).
To switch to the tape mode, however, a cassette tape must have been set.
Also to switch to the CD mode, the separately available CD changer (FXD-C200) must be connected. (See page 1. Fig. 3)

CASSETTE TAPE PLAYBACK

- **Start playback**
Slot the cassette into cassette tape slot door ⑥ then tape playback starts.
- **Tape direction select () . . . ⑦**
Pressing the both buttons tape transport is reversed and playback of other side continues. When the tape end is reached during playback, playback of the other side continues automatically.
- **Fast forward and rewind ( , ) . . . ⑦**
By pressing the button () or (). Tape play stops and skip forward or backward quickly. To stop the fast forward or rewind, press () or () button then come back to play back mode. During FF or REW, the unit will automatically switch to the radio mode.
- **Stop playback () . . . ⑧**
The cassette tape is ejected when the eject button is pressed and Radio reception or CD mode will continue.

RADIO RECEPTION

- **Band button (BAND) . . . ⑨**
Each time the Band button is pressed the Radio frequency band will be switched in following sequence.

→FM1 →FM2 →AM(MW)←

- **Seek & Manual tuning button (▶▶|+, |◀◀-) . . . ⑩**
Depressing shortly (▶▶|+) or (|◀◀-) button, the radio frequency on the digital display will count up or down.
While depressing (▶▶|+) or (|◀◀-) button half a second more, will start SKIP tuning towards higher or lower frequency. When you remove your finger from the button (▶▶|+), (|◀◀-), Automatic tuning start automatically. The tuning process will be stopped when a strong signal is received.
- **Local/Distant Sensitivity (DX/LO) . . . ⑪**
This button has an influence on the STOP level of automatic tuning.
Press (DX/LO) to switch on and hold it for more than 2 seconds in order to receive distant stations. The (DX) indicator is shown. To switch off, press (DX/LO) again in order to receive nearby local stations only. The (DX) indicator goes out.
- **Presetting Stations (1-2-3-4-5-6) . . . ⑫**
First, tune in to the desired station using the automatic tuning system (SEEK) or manually (MANUAL, ▶▶|+ or |◀◀-). To memorize a program, press and hold down the desired preset button for at least two seconds until the program number in the display stops flashing.
In this way you can program 6 different stations or frequencies in the 2 FM band, as well as 6 AM stations.
Before recalling a preset station, select the correct band using the band select button (BAND). The band you have selected is indicated on the digital display.
- **Preset Scan (PSCAN) . . . ⑬**
Press the Band button to select the desired band. Then press and hold in the Preset Scan (P. Scan) button for at least two seconds. The unit will automatically scan the preset stations on the band selected, stopping on each one for approximately 5 seconds. When a station that you wish to listen to is heard, press the Preset Scan (P. Scan) button again. Preset Scan will automatically stop and the unit will remain on the station.
- **Auto-Travel Preset button (ATP) . . . ⑭**
 - When the ATP button is pressed for 2 seconds or more, ATP is displayed and the radio automatically memorizes up to 6 stations beginning with the one with the strongest signal.
 - When the ATP button is pressed for less than 1.5 seconds, the first memorized station is recalled. To recall the stations one after another in the order they were memorized, repeatedly press this button quickly.

NOTE:

- If the signal levels of the broadcasting stations are so weak that no station can be ATP memorized, "000" is displayed and no sound reproduced.

Operation of the CD changer controls

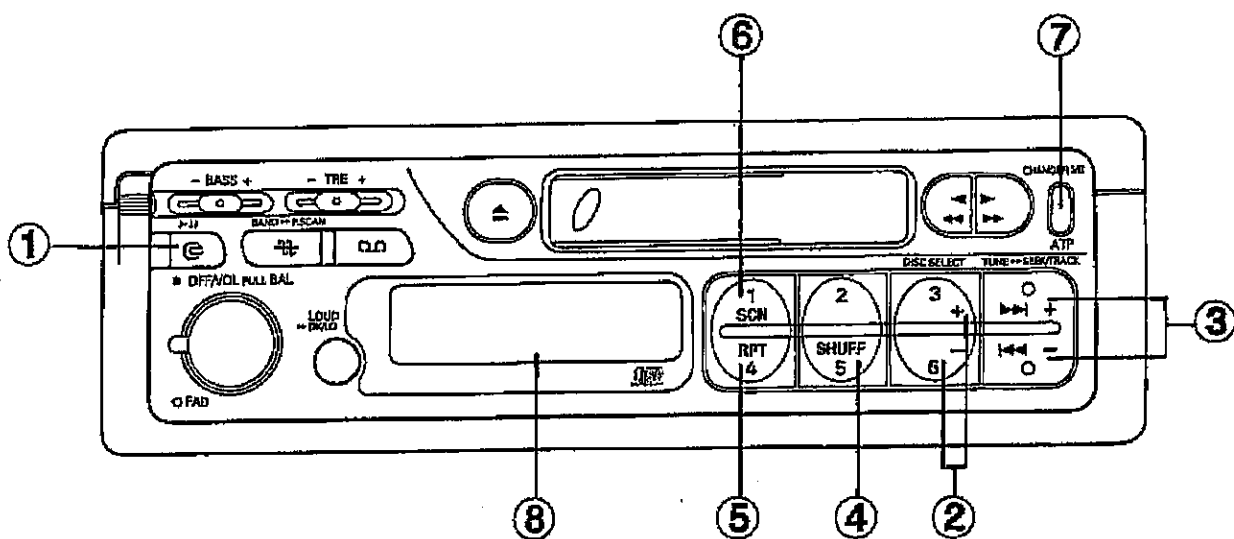

- | | |
|---------------------------------------|--|
| ① CD mode, Play/Pause button (Ⓢ, ▶) | ⑤ Repeat Play button (RPT) |
| ② Disc Select button (-, +) | ⑥ Scan button (SCN) |
| ③ Track Skip button (◀◀-, ▶▶+) | ⑦ Changer Select button (Changer I/II) |
| ④ Shuffle Play button (SHUFF) | ⑧ Digital Display |

SETTING UP FOR OPERATION

Following the instructions of the "FXD-C200" in the "HOW TO HANDLE THE CD MAGAZINE" section, load the desired number (up to 10) of compact discs into the CD magazine and insert the magazine into the changer.

The CD changer automatically starts loading and checks whether the disc is loaded or not.

Basic operations

1. CD mode button (Ⓢ) . . . ①

When the CD mode button is pressed, (Ⓢ) will appear in the display, and play will automatically begin.

- When the changer is used for the first time, or when the CD magazine has been changed, play will begin from the first track of the first disc.

2. Play/Pause button (Ⓢ) . . . ①

When the play/pause button (Ⓢ) is pressed during play, (Ⓢ) will be flashing in the display and play will be temporarily stopped.

When the play/pause button is pressed once again, play will be resumed from the point at which it was stopped.

3. Disc select (-, +) . . . ②

When the (+) disc select button is pressed, the selection will advance to the next disc; and when the (-) button is pressed, the selection will return to the preceding disc.

4. Track select (◀◀ -, ▶▶|+) . . . ③

When the (▶▶|) track select button is pressed, the selection will advance to the beginning of the next track; and when the (◀◀) button is pressed, the selection will return to the beginning of the preceding track.

Note:

— If the (◀◀) button is pressed during play, play will return to the beginning of the track currently being played.

5. Changer select button . . . ⑦

If two disc changers are installed, use this button to select the desired changer.

Note:

— This button must not be pressed if the number of CD changers is 1. If this button is pressed while only 1 CD changer is being attached, the changer stops operating for about 10–20 seconds to check whether there is a 2nd CD changer or not.

Special operations 1

(PAUSE, SHUFFLE, REPEAT, and SCAN)

1. Shuffle play (SHUFF) . . . ④

When the shuffle button (SHF) is pressed, [SHF] will appear in the display, and the tracks on the disc currently being played will be played in a shuffled order.

The shuffle mode can be cancelled by pressing the shuffle button once again.

2. Repeat playback (RPT) . . . ⑤

When the repeat button (RPT) is pressed, [RPT] will appear in the display and the same track will be played repeatedly.

The repeat mode can be cancelled by pressing the repeat button once again.

3. Intro scan play (SCN) . . . ⑥

When the scan button (SCN) is pressed, [SCN] will appear in the display and the beginning of each consecutive track will be played for approximately 10 seconds.

When you find a track to which you wish to listen, press the scan button once again; the scan operation will stop and play will continue from that point.

Special operations 2

(CUE/REVIEW, SHUFFLE, REPEAT, and SCAN)

1. CUE/REVIEW (|◀◀-, ▶▶|+) . . . ③

High-speed audible search to any section of the disc can be made by the Cue and Review functions. Press and hold the Cue (▶▶|) button to advance quickly in the forward direction or press and hold the Review (|◀◀) button to advance quickly in the backward direction.

2. Disc shuffle play (DISC/SHUFF) . . . ④

When the shuffle button (SHF) is held pressed for two seconds or longer, [DISC] and [SHF] will appear in the display, the discs will be selected in a shuffled order, and then the tracks on the selected disc will be played in a shuffled order.

- When all of the tracks on the selected disc have been played, the next disc will be selected in a shuffled order, and then the tracks on that disc will be played in a shuffled order. This operation will be repeated continuously.

3. Disc repeat play (DISC/RPT) . . . ⑤

When the repeat button (RPT) is held pressed for two seconds or longer, [DISC] and [RPT] will appear in the display and the same disc will be played repeatedly.

4. Disc intro scan play (DISC/SCN) . . . ⑥

When the scan button (SCN) is held pressed for two seconds or longer, [DISC] and [SCN] will appear in the display and the beginning of the first track on each disc will be played for approximately 10 seconds; this operation will be repeated continuously.

When you find a disc to which you wish to listen, press the scan button once again, and that disc will be played.

WIRING (See page 1. Fig. 3)

Connect the DIN socket to the CD changer, using DIN cable (8 pin), which is supplied with the "FXD-C200" CD changer.

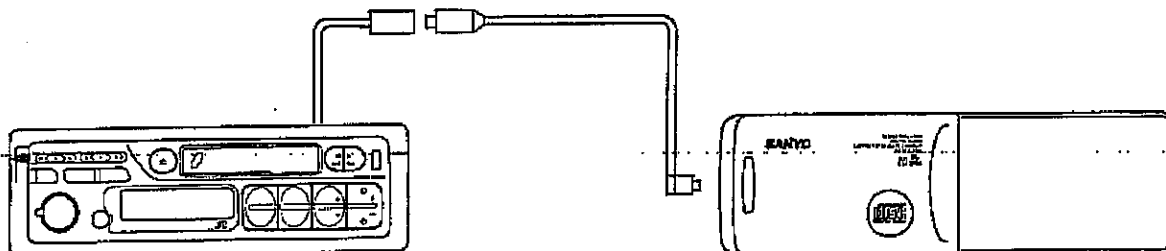

Note

— If a problem should develop while operating the CD changer, the following error signs may be displayed. Refer to the chart below.

Error sign	Cause	Remedy
E 01	Abnormal disc change function.	Contact the place of purchase.
E 30	Excessive temperature in the car is detected.	Allow the car to cool. The error sign will go off when the car temperature decreases.
- - -	The magazine is not fully inserted into the changer.	Completely insert the magazine into the changer, until it clicks in place.
- - -	There are no discs in the magazine.	Insert disc into the magazine.
2 - -	There is no disc in slot number 2.	Insert a disc into slot number 2.

MAINTENANCE

1. When the car stereo is not in use, remove the audio cassette from the tape player.
2. Cassette shells may warp, keep them out of direct sunlight. The shell should not be exposed to heat exceeding 55°C.
3. Never place an audio cassette tape in the vicinity of a strong magnetic field.
4. When replacing the fuse, make sure to use a new 7.5A (maximum rating) fuse for main power.
If a fuse blows again, recheck wiring or have the unit bench tested at a service station.
5. Clean the tape head, pinch roller and capstans at least once a month using a quality audio head cleaning cassette.

INSTALLATION

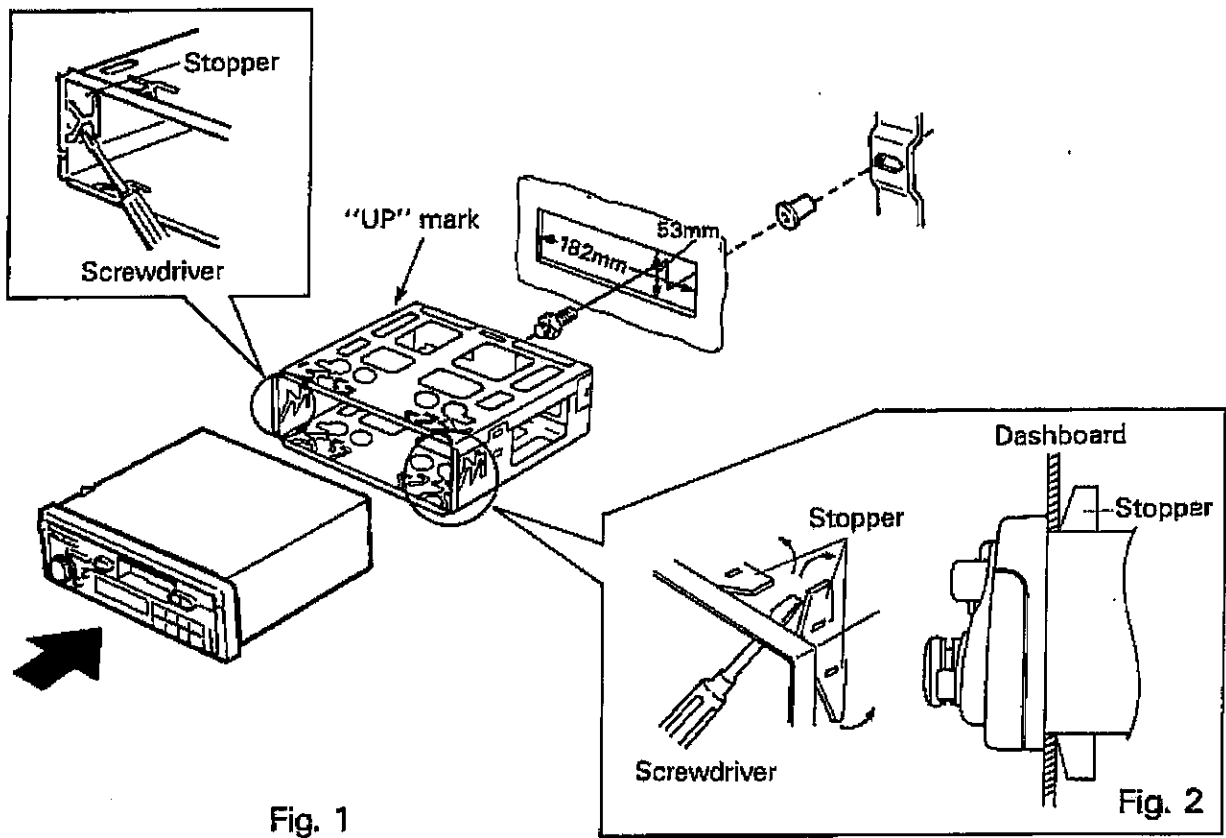

Fig. 1

Fig. 2

1. Insert mounting bracket into DIN-standard cutout 182 × 53mm in the dashboard or a console. (Fig. 1)
The side marked "UP" should be up.
2. Bend the stoppers of the mounting bracket with a screwdriver, and secure the bracket firmly to the dashboard. (Fig. 2)
3. Fix the mounting bracket by using the mounting hardware supplied.
4. Insert the set into the mounting bracket until it locks.

SET REMOVAL

1. Push the on left sides of the handle to raise. (Fig. 3)
2. Pull the handle to remove the set.

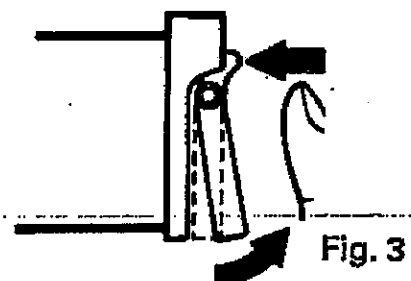
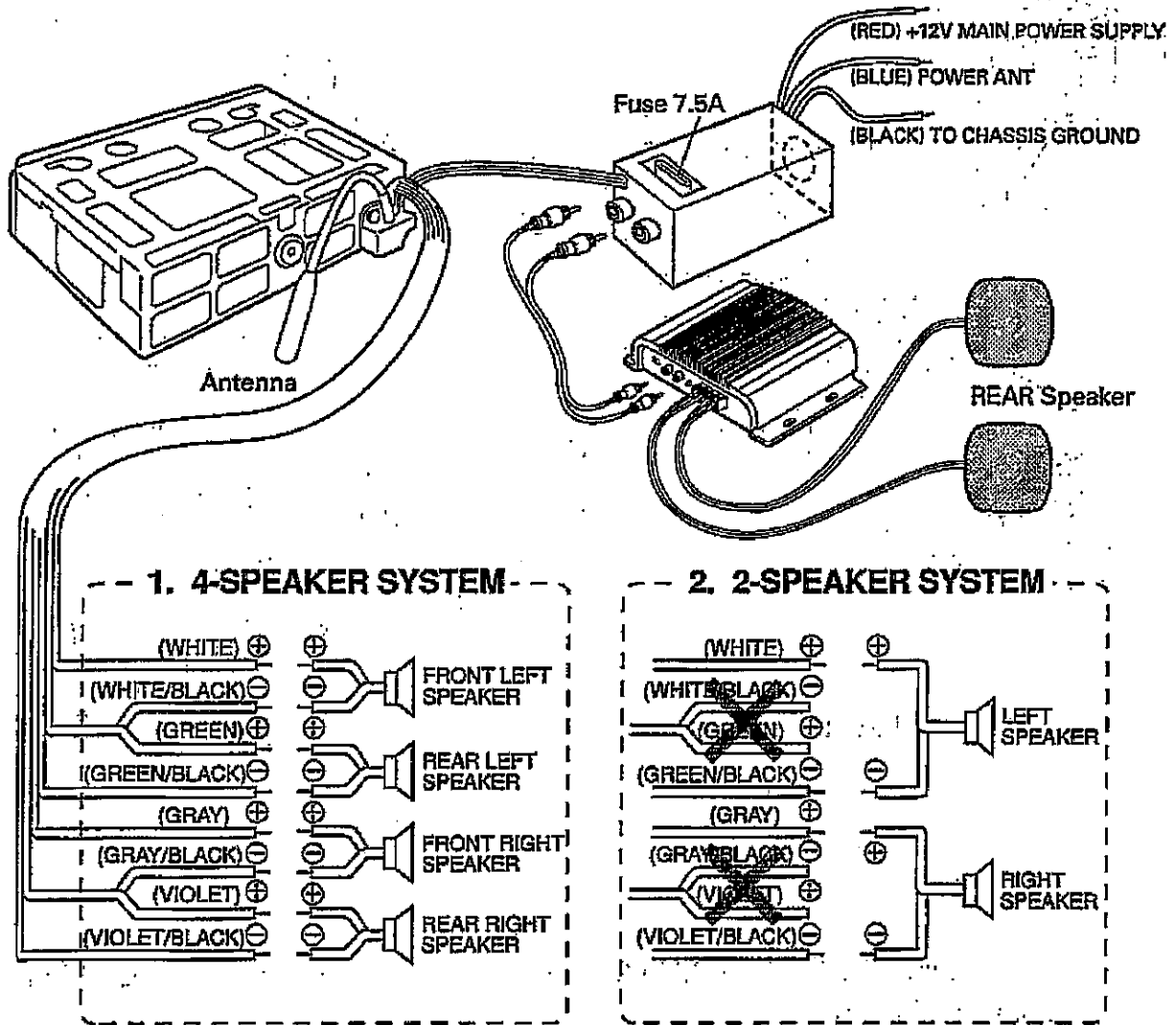

Fig. 3

NOTE:

– When the set is installed again, return the handle to the original position.



NOTE:

- The FADER control has no effect on the output when using a two speaker installation. Under this condition, set the FADER control to the center position.
- When not using an automatic antenna, cover the ends of Blue wire with electrical tape, to prevent it from shorting to the unit or the vehicle chassis.
- When using a two speaker installation, the white/black, green, gray/black and violet wires, which are used for a four speaker installation, are not used. The ends of these wires must be covered with electrical tape, to prevent it from shorting to the unit or vehicle chassis.

3. RCA Line-out jacks

Connect the left and right channel RCA Line-out jacks on the FXR-31GB, to the left and right channel Line-input jacks on the external power amplifier. Output level of the amplifier is controlled by FADER control volume.

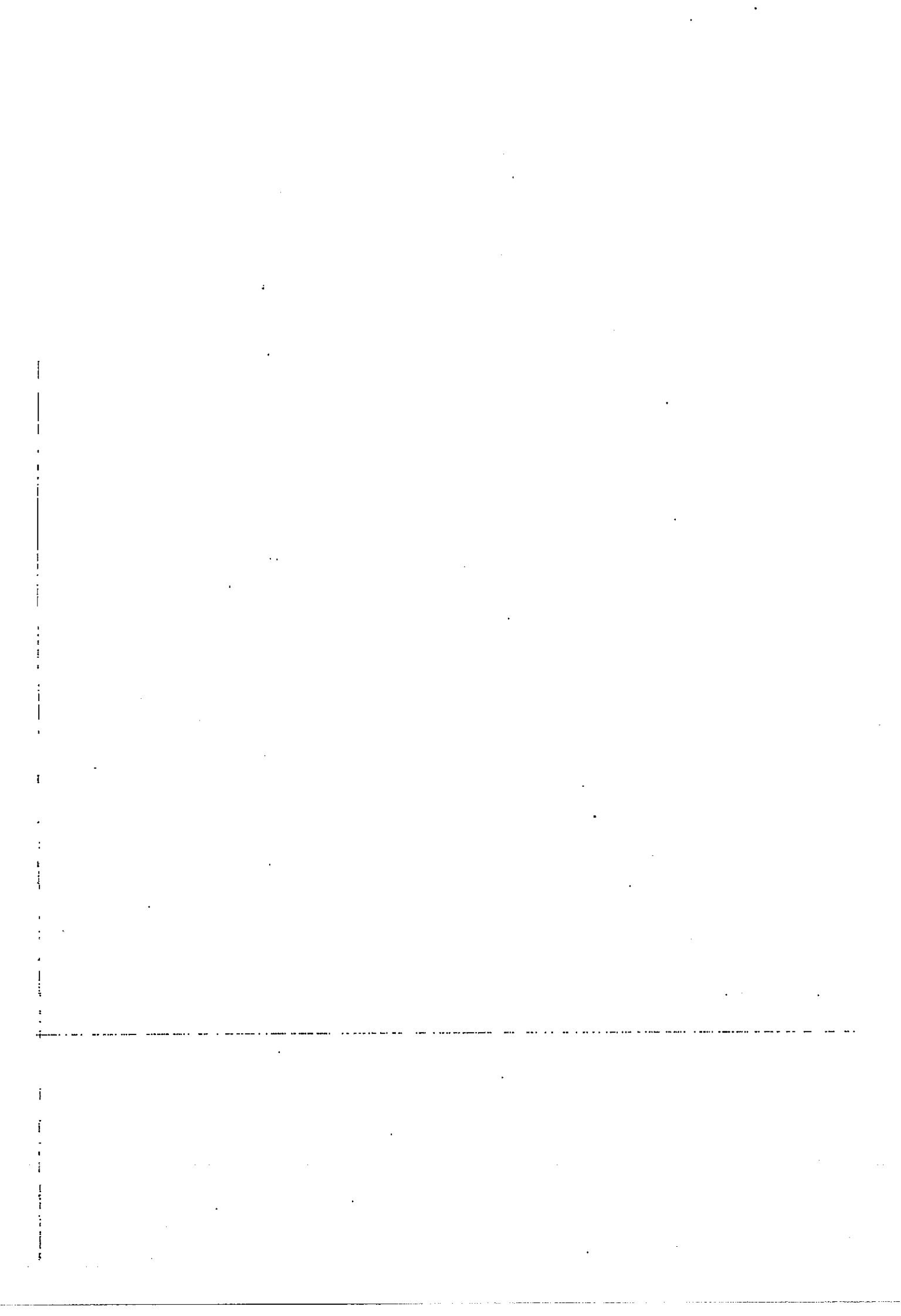

SANYO Electric Co., Ltd.
Printed in Japan
1RA6P10A38300