

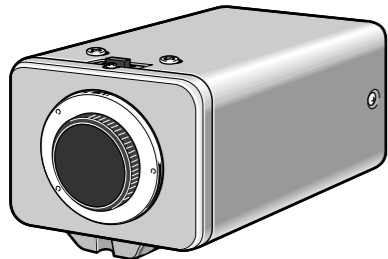

**INSTRUCTION MANUAL**

**VCC-4795P**

**Color CCD Camera**



**About this manual**

Before installing and using the camera, please read this manual carefully. Be sure to keep it handy for later reference.

Depending on the conditions of use, installation and environment, please be sure to make the appropriate settings and adjustments. If you need help with installation and/or settings, please consult your dealer or an Authorized Sanyo Service Center.

**DIMENSIONS (Unit: mm)**

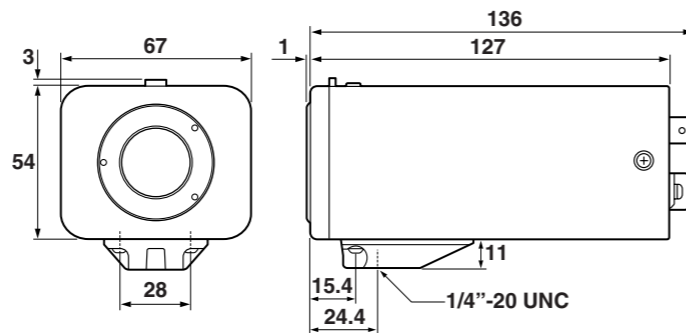

**PRECAUTIONS**

**■ In case of a problem**

Do not use the unit if smoke or a strange odor comes from the unit, or if it seems not to function correctly. Turn off the power immediately and disconnect the power cord, and then consult your dealer or an Authorized Sanyo Service Center.

**■ Do not open or modify**

Do not open the cabinet, as it may be dangerous and cause damage to the unit. For repairs, consult your dealer or an Authorized Sanyo Service Center.

**■ Do not put objects inside the unit**

Make sure that no metal objects or flammable substance get inside the unit. If used with a foreign object inside, it could cause a fire, a short-circuit or damage. Be careful to protect the unit from rain, sea water, etc. If water or liquid gets inside the unit, turn off the power immediately and disconnect the power cord, and then consult your dealer or an Authorized Sanyo Service Center.

**■ Be careful when handling the unit**

To prevent damage, do not drop the unit or subject it to strong shock or vibration.

**■ Do not install this unit close to magnetic fields**

The magnetic fields may result in unstable operation.

**■ Protect from humidity and dust**

To prevent damage, do not install the unit where there is greasy smoke or steam, where the humidity may get too high, or where there is a lot of dust.

**■ Protect from high temperatures**

Do not install close to stoves, or other heat sources, such as spotlights, etc., or where it could be subject to direct sunlight, as this could cause deformation, discoloration or other damages.

Be careful when installing close to the ceiling, in a kitchen or boiler room, as the temperature may rise to high levels.

**■ Cleaning**

Dirt can be removed from the cabinet by wiping it with a soft cloth. To remove stains, wipe with a soft cloth moistened with a soft detergent solution and wrung dry, then dry by wiping with a soft cloth.

Do not use benzine, thinner or other chemical products on the cabinet, as this may cause deformation and paint peeling. Before using a chemical cloth, make sure to read all accompanying instructions. Make sure that no plastic or rubber material comes into contact with the cabinet for a long period of time, as this may cause damage or paint peeling.

**CONNECTION EXAMPLE**

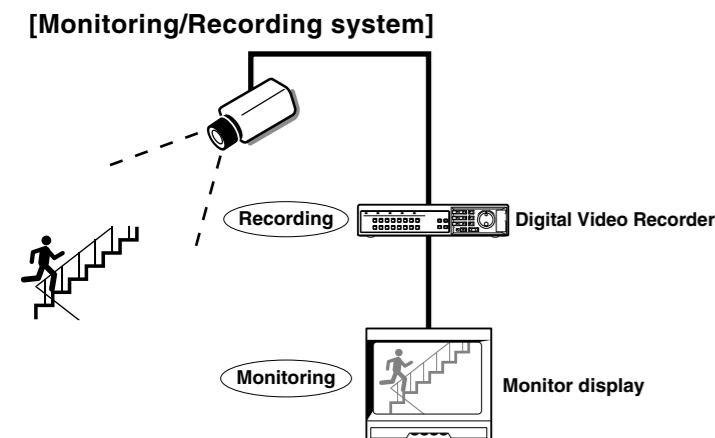
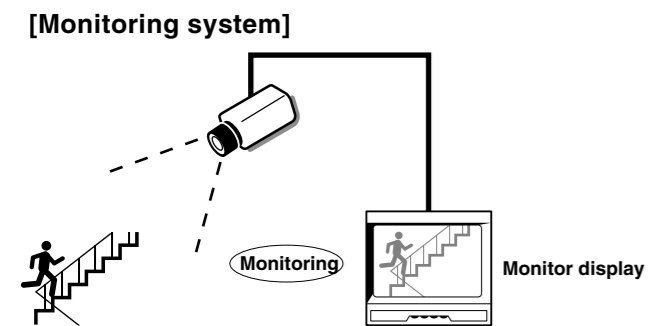

**SPECIFICATIONS**

Scanning system	: PAL standard 625 lines, 50 fields/sec.
Image sensor	: 1/3" interline transfer method CCD
Number of effective pixels	: 752 (H) x 582 (V)
Horizontal resolution	: More than 520 TV lines
Minimum illumination (approx.)	: Gain high: 0.01 lx (F 1.2, B/W mode), 0.45 lx (F1.2, color mode) Gain normal: 0.02 lx (F 1.2, B/W mode), 0.6 lx (F1.2, color mode)
Video output	: 1.0 V(p-p)/75 Ω, composite, BNC
Video S/N ratio	: More than 48 dB (AGC off: More than 50 dB)
Backlight compensation	: OFF, Multi-spot metering (High/Normal), Center zone metering
White balance	: ATW/Manual
Gain control	: Normal/High
Light control	: Optical auto iris lens/Electronic iris (indoor use)
Lens mount	: CS mount
Flange back	: 12.5 mm ± 0.5 mm adjustment
Electronic shutter	: 1/50, 1/120, 1/500, 1/1000, 1/2000, 1/4000, 1/10000 sec.
Aperture compensation	: Sharp/Normal
Sync system	: Internal sync/Line lock
Day/Night mode	: Auto (High/Low), Manual (at CONTROL terminal)
Operating Environment	: Temperature: -10°C - +50°C (14°F - 122°F) Humidity: less than 90 % RH (no condensation)
Power supply	: 24 V AC ±10%, 50 Hz/ 12 - 15 V DC
Power consumption (approx.)	: 3.7 W (with auto-iris lens)
Weight (approx.)	: 400 g (without lens)

Appearance and specifications are subject to change without prior notice or obligations.

**TROUBLESHOOTING**

Before sending the camera out for repair, check the items below. If the problem persists after checking these items, consult your dealer or an Authorized Sanyo Service Center.

**■ If no image appears**

- Is the coaxial cable attached securely?
- Are the power and voltage normal?
- Has the iris of the lens been adjusted correctly (with the LEVEL dial)?
- Is there adequate illumination?

**■ If the image is unclear**

- Is the monitor adjusted correctly?
- Is the flange-back position correctly set?
- Is the lens in focus?
- Is the lens clean?  
Dirt or fingerprints on the lens can adversely affect the image. Gently wipe any dirt or fingerprints off the lens with a soft cloth or lens cleaning paper and cleaning fluid (commercially available).

**SERVICE**

The camera is a precision instrument. Handle it carefully and always follow the safety precautions. If the camera requires service, never try to repair it yourself or open the casing.

For servicing, maintenance, or repairs, consult your dealer or an Authorized Sanyo Service Center.

Printed on recycled paper

1AC6P1P2970--  
L5BG2/XE (0705KP-SY)



**SANYO Electric Co., Ltd.**  
Printed in Japan

**Please note:**  
Your SANYO product is designed and manufactured with high quality materials and components which can be recycled and reused.

This symbol means that electrical and electronic equipment, at their end-of-life, should be disposed of separately from your household waste.

Please dispose of this equipment at your local community waste collection/recycling centre. In the European Union there are separate collection systems for used electrical and electronic products.

Please help us to conserve the environment we live in!

**This symbol mark and recycle system are applied only to EU countries and not applied to countries in other areas of the world.**

# CONNECTIONS AND ADJUSTMENTS

## Attaching the lens

Use any DC type and CS mounting lens equipped with an auto iris (sold separately).

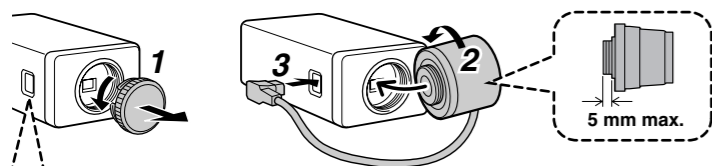

### Pin layout for LENS terminal

Brake coil (-) Drive coil (+)  
Brake coil (+) Drive coil (-)

- Depending on the type of the lens, the shape of the lens plug may differ. In this case, consult your dealer or an Authorized Sanyo Service Center.
- Apply adapter ring (sold separately) when you use any C mounting lens.

## Camera attachment

When attaching the camera, make sure to verify that the attachment surface will allow full tightening of the screws. Plaster board, etc., may not give a strong enough attachment, and it is recommended to use a reinforcement, or other method so that the screws are anchored securely.

- When monitoring lighting or other extremely bright objects (which exceed the maximum required illumination), smearing may occur in the vertical or horizontal direction (either above and below the high-brightness object or as a perpendicular band). In such a case, adjust the angle of illumination and other factors while observing the monitor.
- You can change the bracket topside down. Make sure to use the longer screws (A) to secure the bracket.

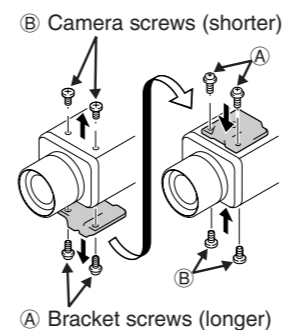

## Flange-back adjustment

This normally does not need adjustment. If the picture is out of focus at the telephoto position, adjust the flange-back position as described below.

3 Set to the maximum wide-angle position and focus the picture.

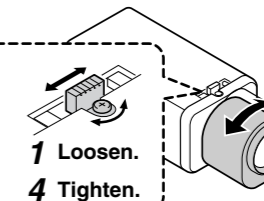

Repeat steps 2 and 3 until the image stays in-focus when changing from a wide-angle position to a telephoto position.

## Supported coaxial cables

Cable type – Length: RG-59U (3C-2V) – 250 m max., RG-6U (5C-2V) – 500 m max., RG-11U (7C-2V) – 600 m max.

- When using an RG-59U (3C-2V) cable, do not use it on piping or air wiring.
- If you use a cable other than the type above, the image or sync signal will be attenuated and will not be transmitted correctly.

## Power cable

<AC 24 V connection>

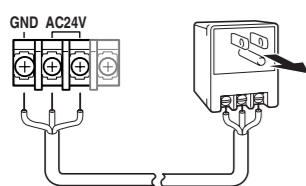

To prevent a fire hazard use any UL listed wire rated VW-1.

<DC 12 V connection>

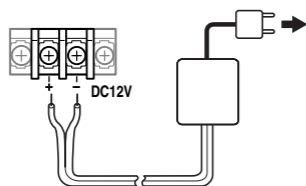

Check that polarity is correct.

## CONTROL terminal connection

Under near infrared lighting or other similar conditions, hunting reaction may occur because the Day/Night function is not carried out normally. In such case, refer to the following diagram for cable connection to fix the image either to color or black-and-white by using an external switch, etc.

	CONTROL terminal (○ indicates a connection point.)		
	C (Color)	B (B/W)	G (Ground)
B/W	○	○	○
Color	○	○	○
Day/Night function*	○	○	○

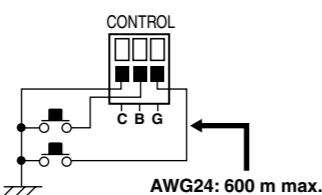

\* You can control the timing for automatic switchover between color and black-and-white images by using the C-BW switch. (Refer to "Day/Night function switchover point".)

You cannot control the switchover operation by using an external switch, etc., while switching between color and black-and-white images is actually in progress by the DAY/NIGHT function.

## Camera adjustments/settings

The camera comes pre-adjusted and ready to install at the time of factory shipment, but you can make adjustments or settings if you need.

If you have trouble adjusting the camera, consult your dealer or an Authorized Sanyo Service Center.

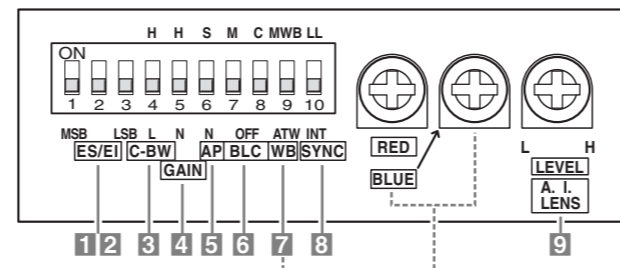

### 1 EI setting (for indoor use)

Only when using a manual or fixed iris lens (EI)



- Set the lens aperture to the shortest F spot.
- When using a manual or fixed iris lens under fluorescent light, the image may flicker.

### 2 Electronic shutter speed setting

(unit: second)

1/50	1/120	1/500	1/1000
1 2 3	1 2 3	1 2 3	1 2 3
1/2000	1/4000	1/10000	
1 2 3	1 2 3	1 2 3	

- Using the high speed electronic shutter indoors with low lighting, will give darker pictures. In such a case, add some lights to make sure the lighting is sufficient.
- If the lighting is very bright, pay attention to the light angle in order to avoid or minimize the smear phenomenon effect.
- If the entire image is too dark or too bright, refer to the "Lens iris level adjustment"

### 3 Day/Night function switchover point

This switch is used to set the timing for automatic switching between color and black-and-white images.

- Set the switchover point to brighter side so that the automatic switch may trip in brighter condition for switchover between color and black-and-white images.



- Set the switchover point to darker side so that the automatic switch may trip in darker condition for switchover between color and black-and-white images.



- The color image will be displayed first when the power is turned on.
- When switching between color and black-and-white images automatically, it is normal for movement of the optical filter to be heard and for a vertical black band to move across the screen.
- Switching from black-and-white to color may occur if there is a significant degree of reflection from the object when using infrared illumination in black-and-white image. Adjust the illumination to avoid switching to color image.
- The focus setting position may differ between color and black-and-white images. Carry out adjustment to ensure that the focus for both images is in the optimum position.

### 4 Auto gain control (AGC)

High sensitivity Increased electronic sensitivity to obtain a bright image in a lower illuminance*	Normal sensitivity
5	5

\* This setting causes noise generation and a grainy image.

### 5 Aperture compensation

Sharp outline	Normal outline
6	6

### 6 Backlight compensation

Only when using an auto-iris lens



Multi-spot metering Backlight compensation to the entire screen*	Center zone metering Backlight compensation to the central portion of the screen	OFF
High Normal		
7 8	7 8	7 8

\* If the background of the object is extremely dark, set to Center zone metering.

### 7 White balance (color compensation)

Manual White Balance	Auto-Tracing White balance
9	9

### 8 Sync setting

Line-Lock (Only when using an AC power supply) Synchronizes the unit with power frequency*	Internal sync
10	10

\* Adjust the roll by turning the LINE PHASE dial on the second and subsequent cameras.

If the vertical roll cannot be corrected by adjusting the LINE PHASE dial on the second and subsequent cameras, try adjusting the LINE PHASE dial on the first camera. If it still cannot be corrected, please check that the polarity of the power cords of all connected devices is correct.

### 9 Lens iris level adjustment

When using an auto-iris lens, if the entire image is too dark or too bright, adjust the contrast.

