

FILE COPY

SANYO

INSTRUCTION MANUAL

Colour Television

C20PE70
C20ZE70
C21PM40
C21ZM40
C21PM45
C21ZM45

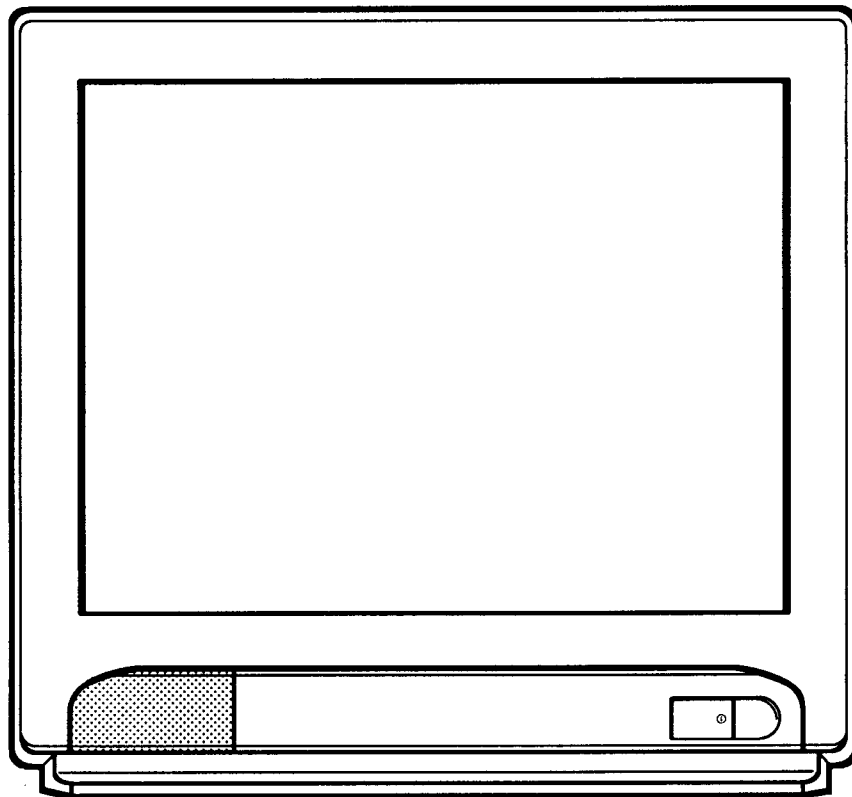

Remote Control
Special Function
AV Input and Output Terminals

Model C21PM45, C21ZM45 – Equipped with the Teletext Decoder.

Contents

Aerial Connection	2
Warnings and Precautions.....	3
Controls	4
General Operation.....	5
Special Functions.....	9
Tuning of the Channels.....	12
Teletext Usu(Model C21PM45, C21ZM45 only).....	14
Connecting other Equipment.....	19
Specifications.....	21
Battery installation (Remote Control Transmitter).....	21

Electric Mains

The receiver is designed to operate on an A.C. mains supply of 220-240Volts 50Hz.

Aerial Connection

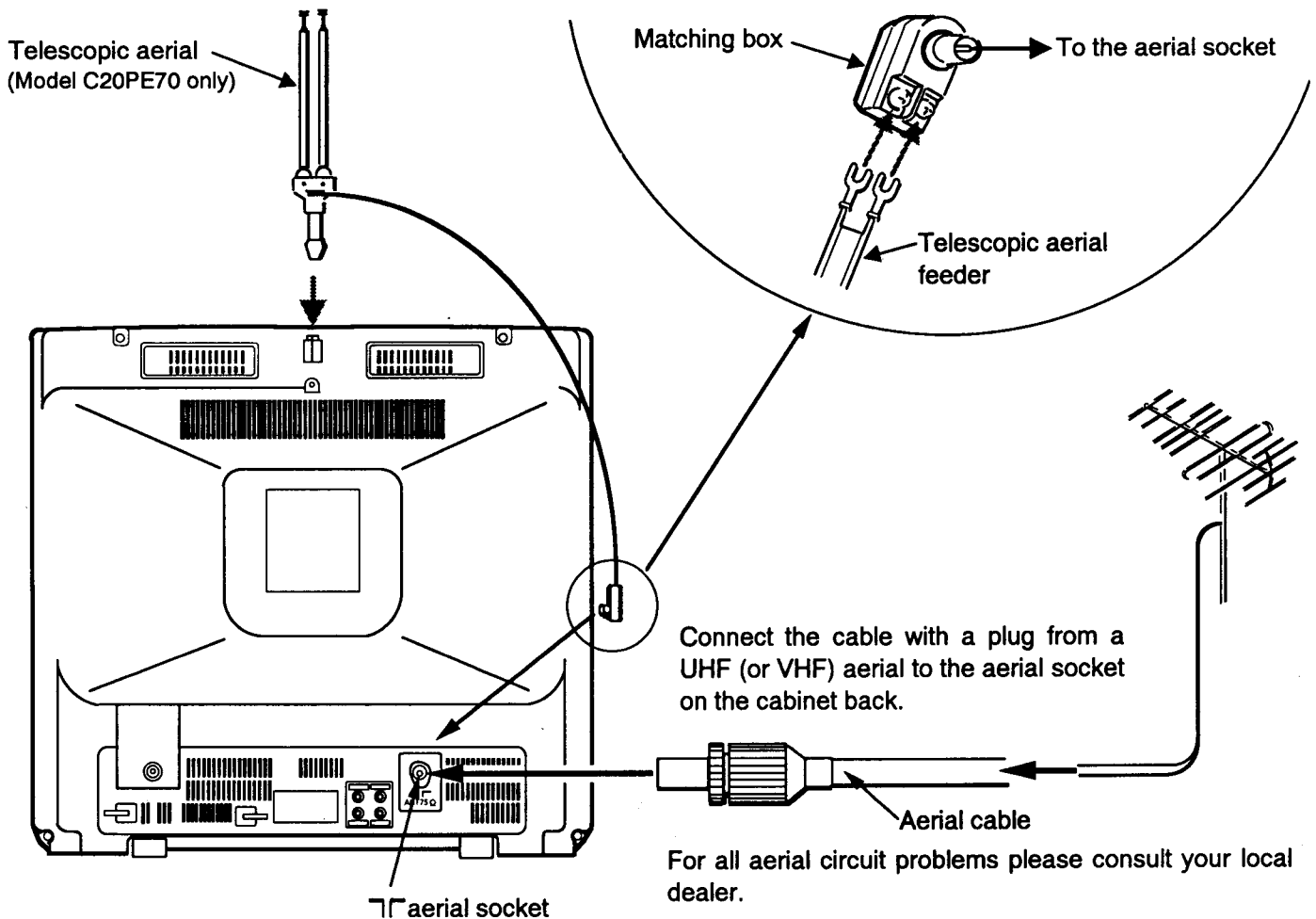

Warnings and Cautions

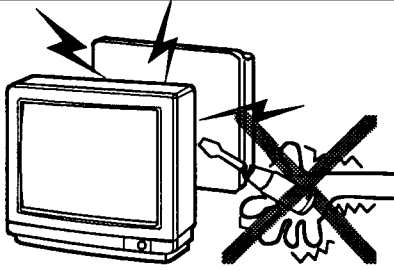

Warning

High voltages are used in the operation of this television receiver. Do not remove the cabinet back from your set. Refer servicing to qualified service personnel.

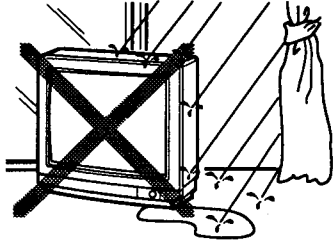

Warning

To prevent fire or electrical shock hazard, do not expose the television receiver to rain or moisture.

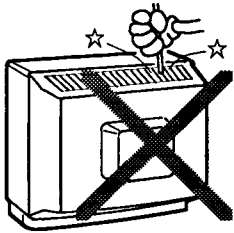

Warning

Do not drop or push objects into the television cabinet slots or openings. Never spill any kind of liquid on the television receiver.

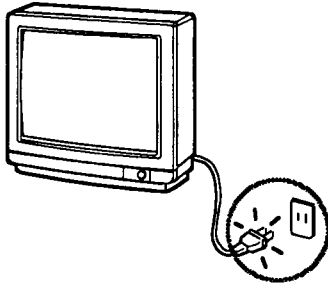

Caution

When the television receiver is not used for an extended period of time, it is advisable to disconnect the AC power cord from the AC outlet.

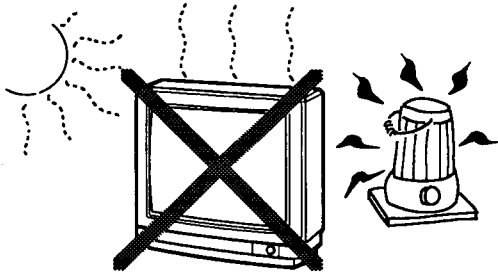

Caution

Avoid exposing the television receiver to direct sunlight and other source of heat. Do not stand the television receiver directly on other products which give off heat. E.g. video cassette players, audio amplifiers.

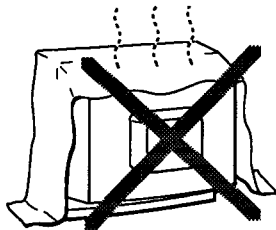

Caution

Do not block the ventilation holes in the back cover. Adequate ventilation is essential to prevent failure of electrical components.

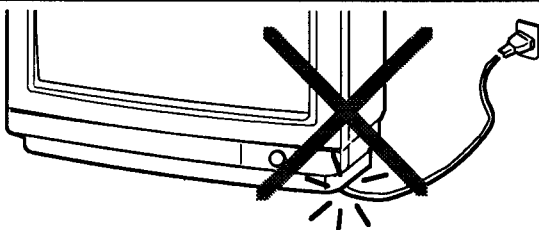

Caution

Do not squash power supply cord under the television receiver.

Controls

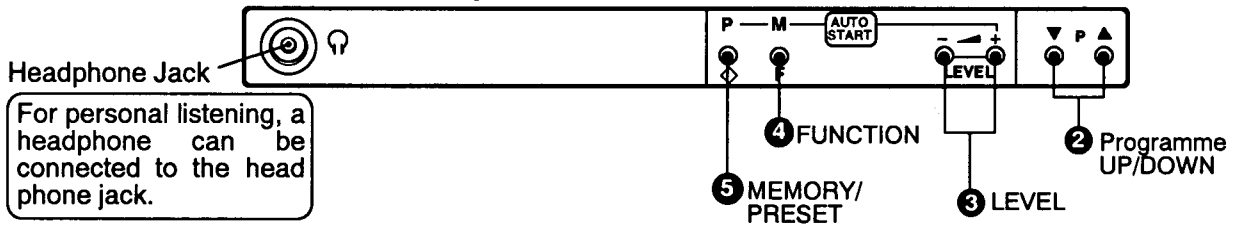
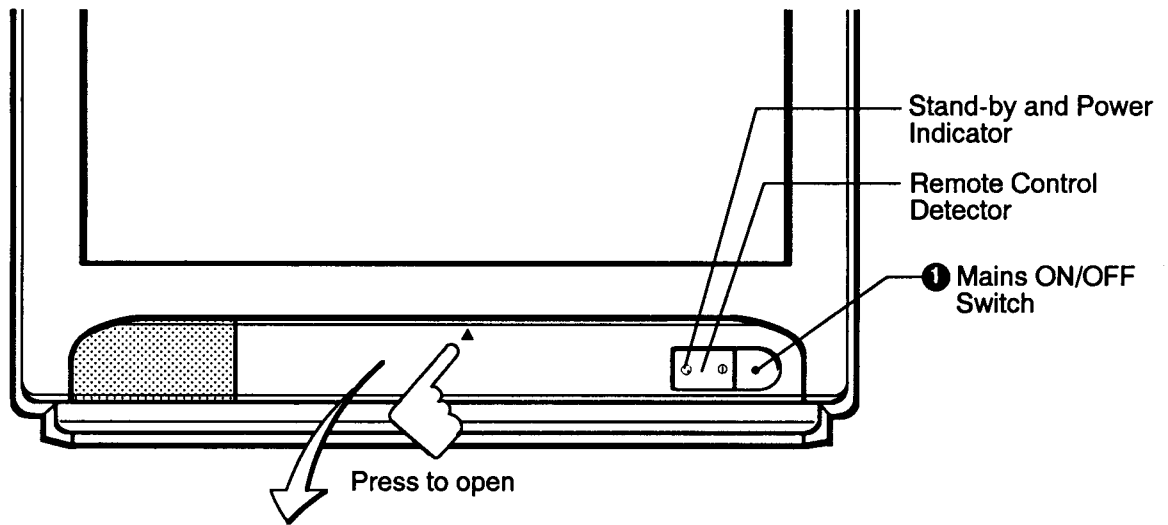

Remote Control Transmitter

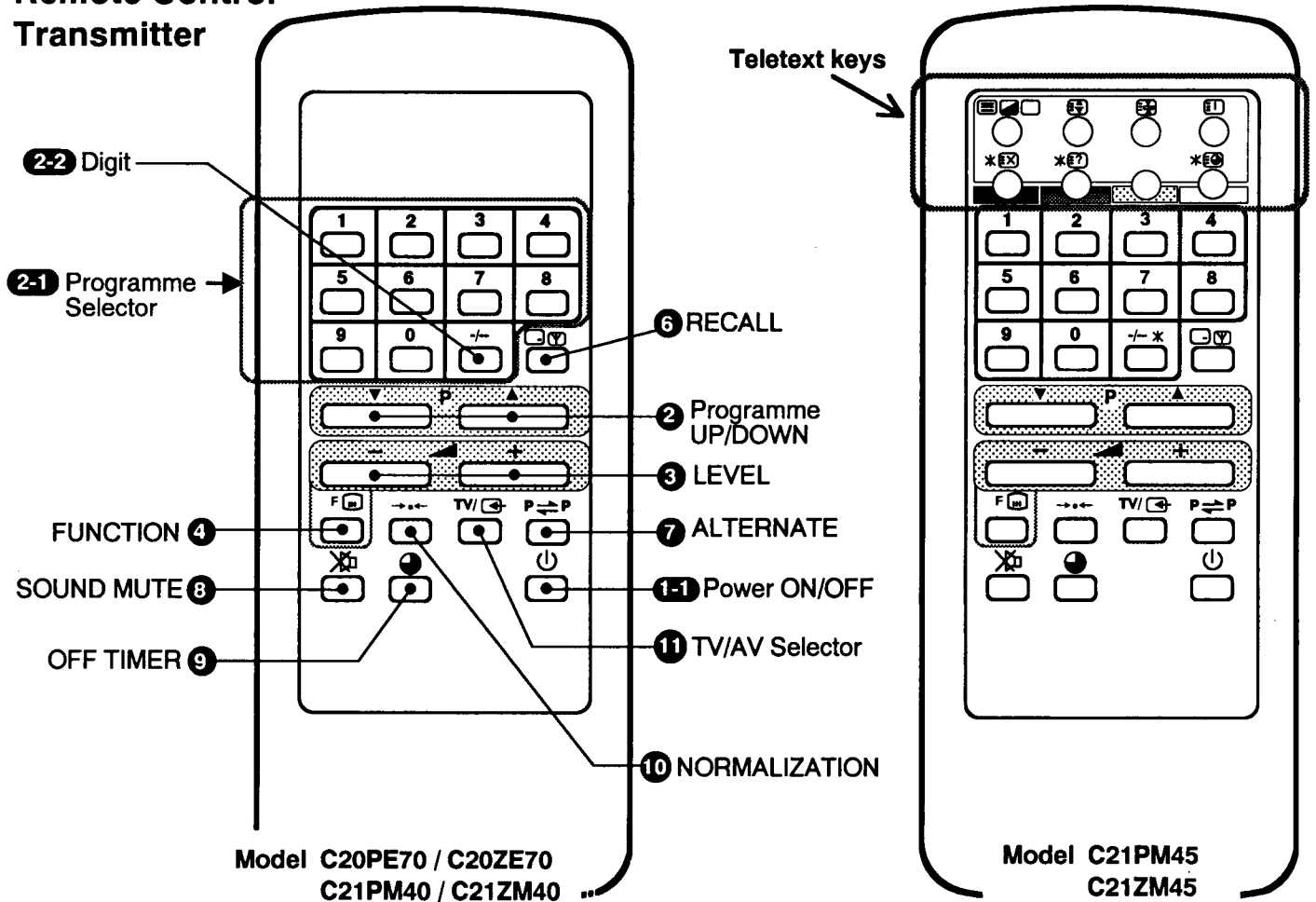

General Operation

POWER ON/OFF

To switch on or off the TV;

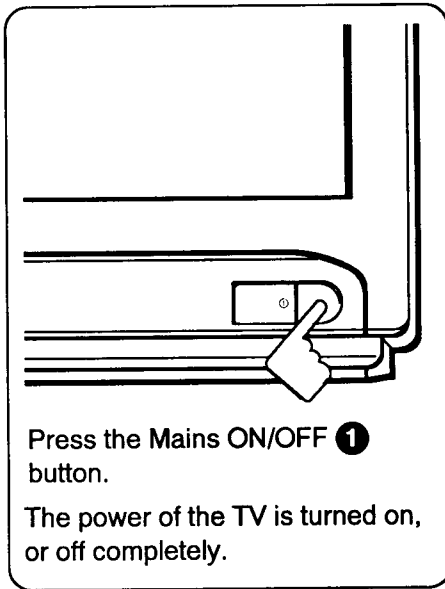

To set the TV to standby mode;

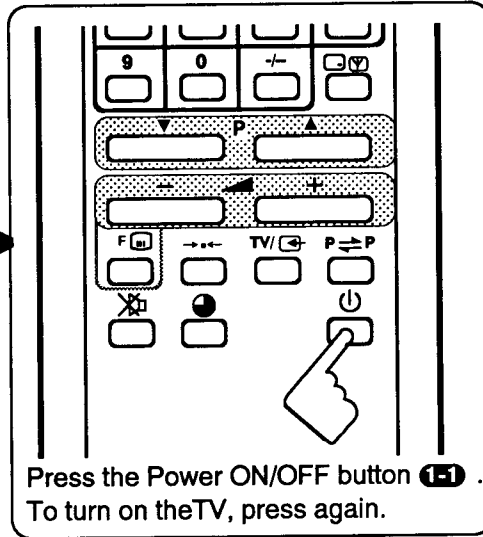

To turn on the TV from standby mode;

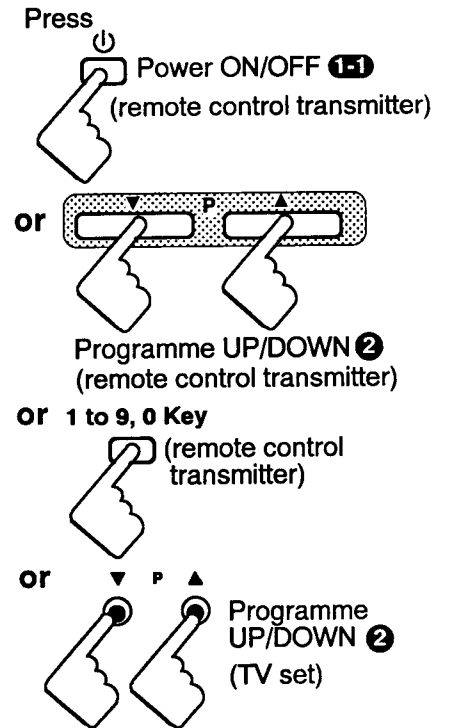

Important !

Be sure to set the Mains ON/OFF switch ① to the off position, if the power failure occurs while viewing.

AUTO SHUT OFF

This TV set incorporates the AUTO SHUT OFF function. Even if the TV is left on after you have gone to sleep, the TV set changes to the standby mode within 10 minutes after all broadcasts have ended.

Remaining time

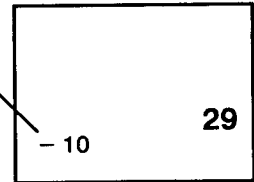

PROGRAMME SELECTION (Direct Selection)

To select a programme directly

For example;

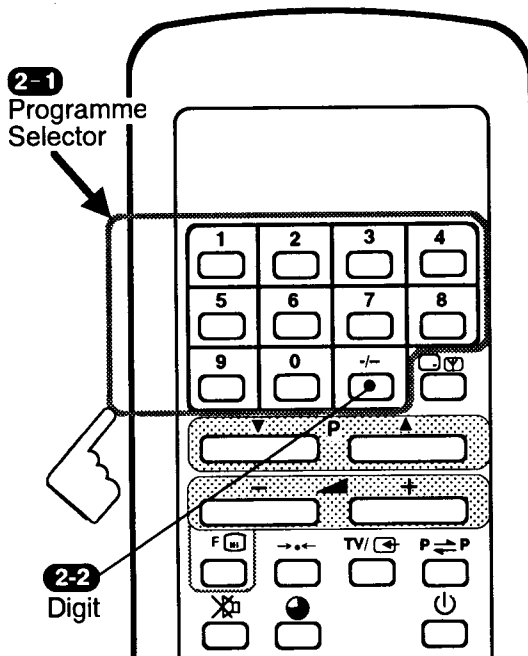

To select a programme 8

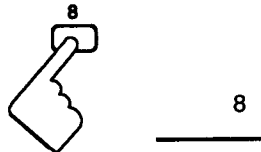

To select a programme 10

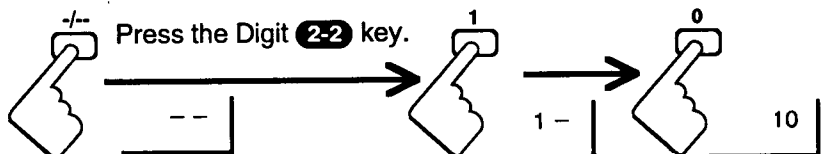

To select a programme 27

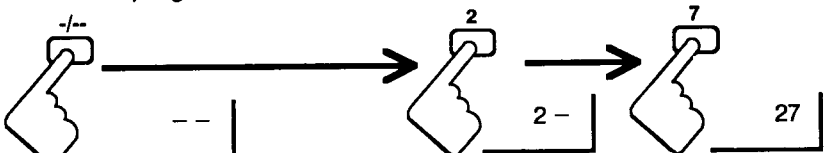

General Operation

Programme Selection (Programme UP and Down)

To select a channel

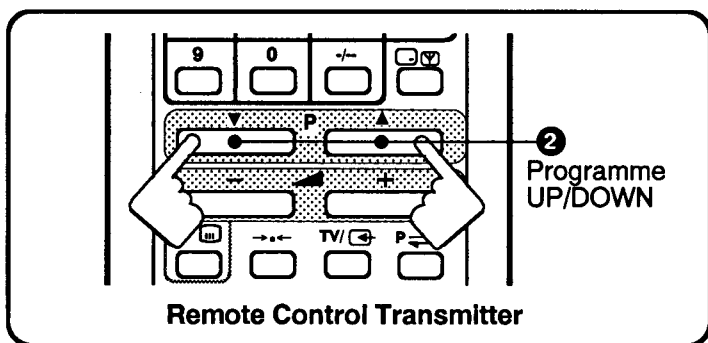

or

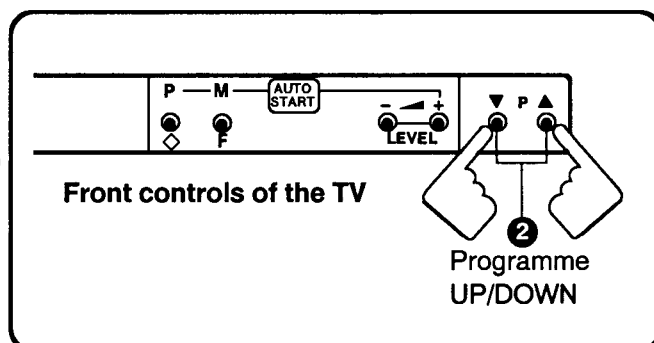

Volume Control

To adjust the sound volume

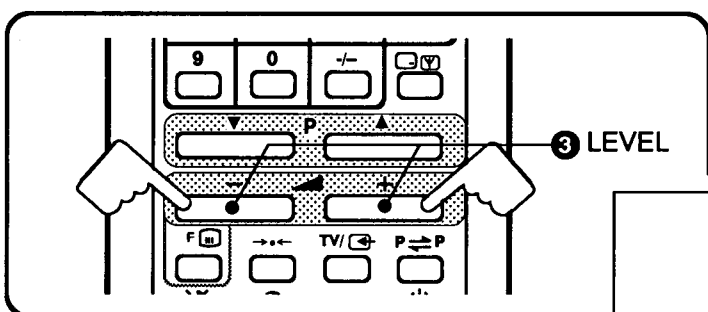

or

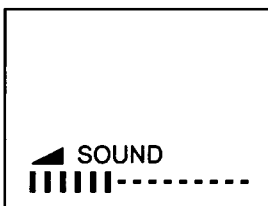
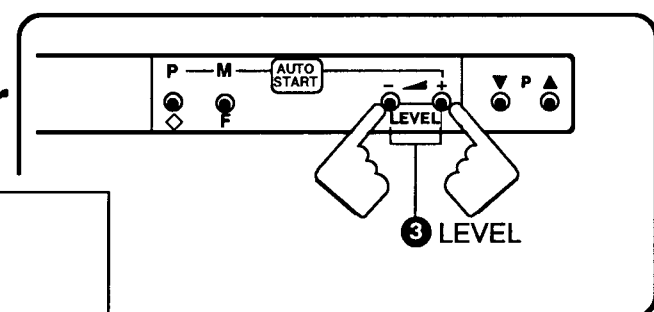

RECALL

To display the on screen indications, press the RECALL key.

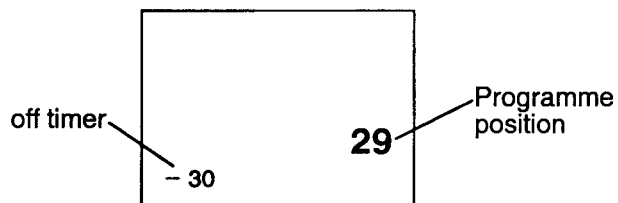
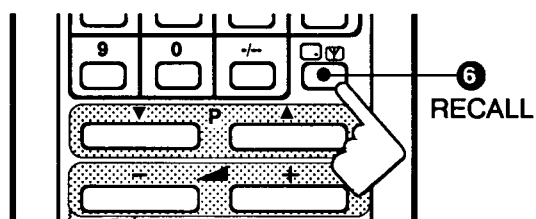

Screen display disappears after about 5 seconds.

ALTERNATE

Press the ALTERNATE **7** key, and the programme position will alternately select the previous position and the present position.

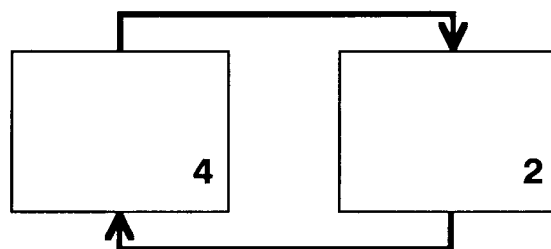
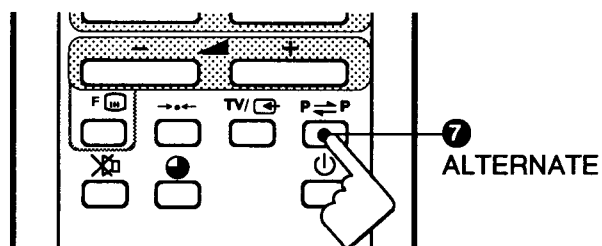

For example, now you are watching programme position "4" but you watched programme position "2" previously. If you press the ALTERNATE key, programme position "2" immediately appears.

General Operation

SOUND MUTE

Should you wish to mute the sound (e.g. While talking on the telephone), press the SOUND MUTE **8** key.

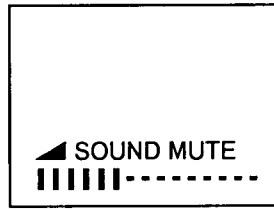
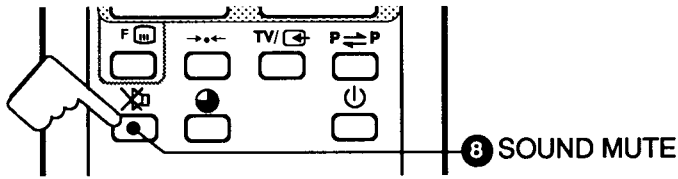

To switch the sound back on, press SOUND MUTE key again.

OFF TIMER

The TV set will be turned off after about 30, 60, 90 or 120 minutes.

Press the OFF TIMER **9** key.

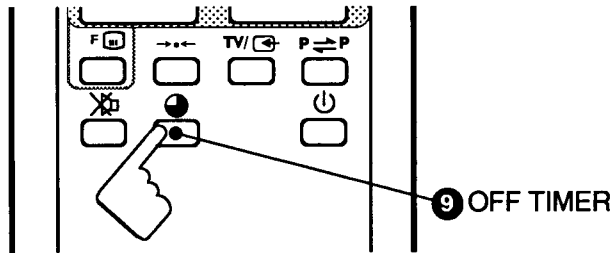

To cancel the OFF TIMER

Press the OFF TIMER key until " -- " appears.

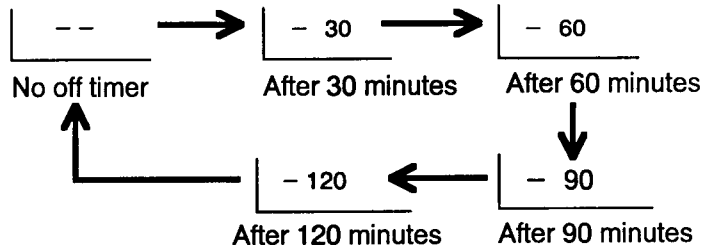

Just one minute before switching off the TV, " - 01 " and channel number will be displayed on the screen.



MEMORY

This function lets you store the settings (for colour, brightness, contrast, sharpness, sound volume) in memory for both picture and the sound, and these setting levels can be recalled by pressing the NORMALIZATION **10** key of the remote control transmitter.

To store the picture and sound settings

(1) Set the picture and sound to the desired levels. →

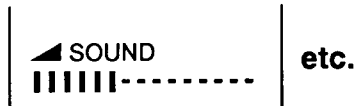

etc.

(2) Press the MEMORY/PRESET **5** button while the control function display is still visible on the screen.

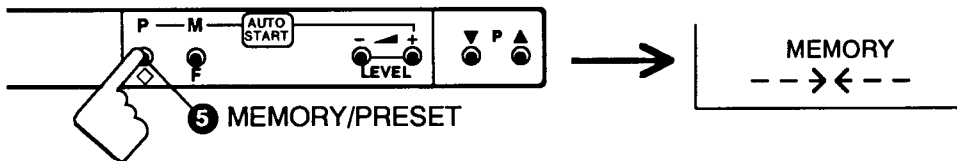

NOTE: The control settings will not be saved if the MEMORY button is pressed after the control function display has left the screen.

NORMALIZATION

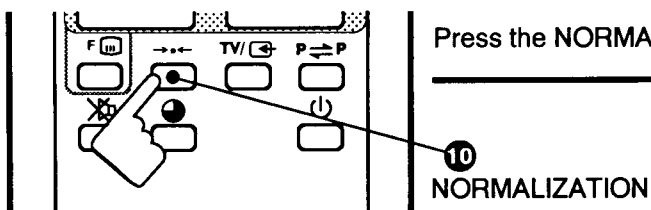

Press the NORMALIZATION **10** key.



The colour, brightness, contrast, sharpness and sound volume settings which you stored using the MEMORY button are recalled.

General Operation

PICTURE ADJUSTMENTS

(1) Select the adjustment item using the **FUNCTION 4** key.

(2) Adjust using the **LEVEL 3** + and - key .

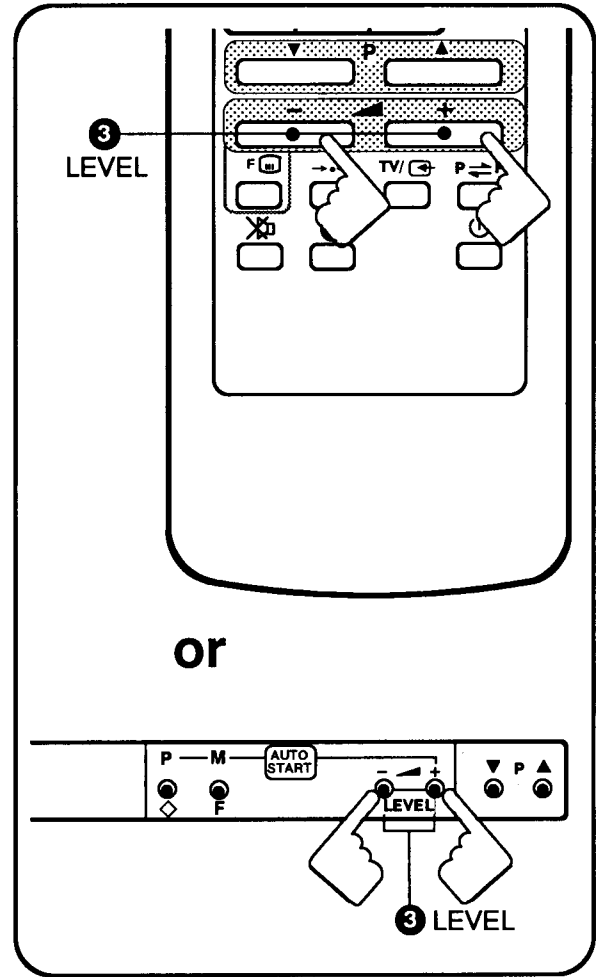
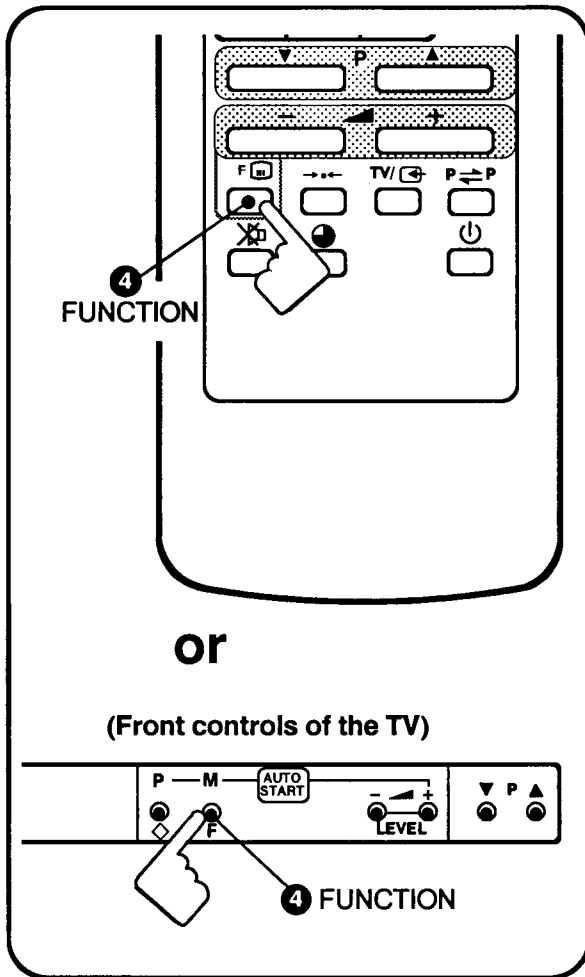

Each time the **FUNCTION 4** key is pressed, function choice will change as follows;

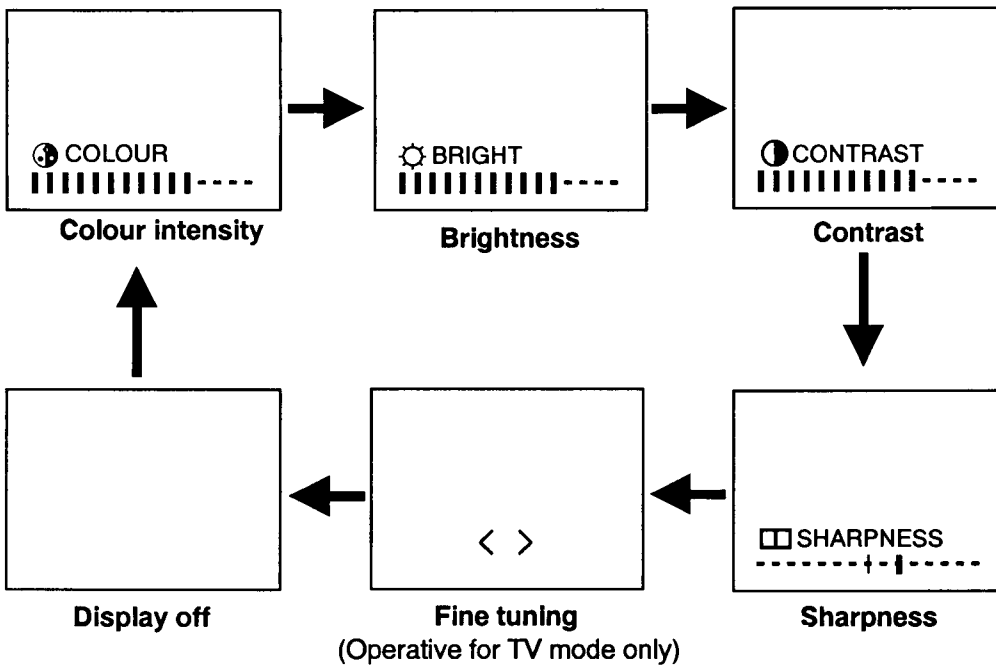

Special Functions

You can set the special functions by inputting the special codes using the RECALL **6** key and the Programme Selector **251** of the remote control transmitter.

Special codes and special functions are as follows

Special code	Special functions
SP 00	Reset all special functions (The start condition for the TV power is changed to the standby start).
SP 01	Reset all special functions.
SP 30	Cancellation special code "31".
SP 31	Maximum volume level setting and prohibition of channel tuning function.
SP 40	Setting of the start up condition for the TV programme. (Always switched on in previous programme position)
SP 41	Setting of the start up condition for the TV programme. (Always switched on in programme position "1")
SP 42	Setting of the start up condition for the TV programme. (Always switched on in programme position "2")
SP 43	Setting of the start up condition for the TV programme. (Always switched on in programme position "3")
SP 44	Setting of the start up condition for the TV programme. (Always switched on in programme position "4")
SP 45	Setting of the start up condition for the TV programme. (Always switched on in programme position "5")
SP 46	Setting of the start up condition for the TV programme. (Always switched on in programme position "6")
SP 47	Setting of the start up condition for the TV programme. (Always switched on in programme position "7")
SP 48	Setting of the start up condition for the TV programme. (Always switched on in programme position "8")
SP 49	Setting of the start up condition for the TV programme. (Always switched on in AV mode)
SP 50	Change of the start condition for the TV power (Setting to the standby start).
SP 51	Change of the start condition for the TV power (Setting to the normal start).
SP 60	Cancellation special function 61.
SP 61	Suppression of the auto shut off function.

Note: Special functions are not cancelled when the power is turned off or when the AC power plug is disconnected from the mains.

Example: To input special code "49" (The input method is the same for all the special codes.)

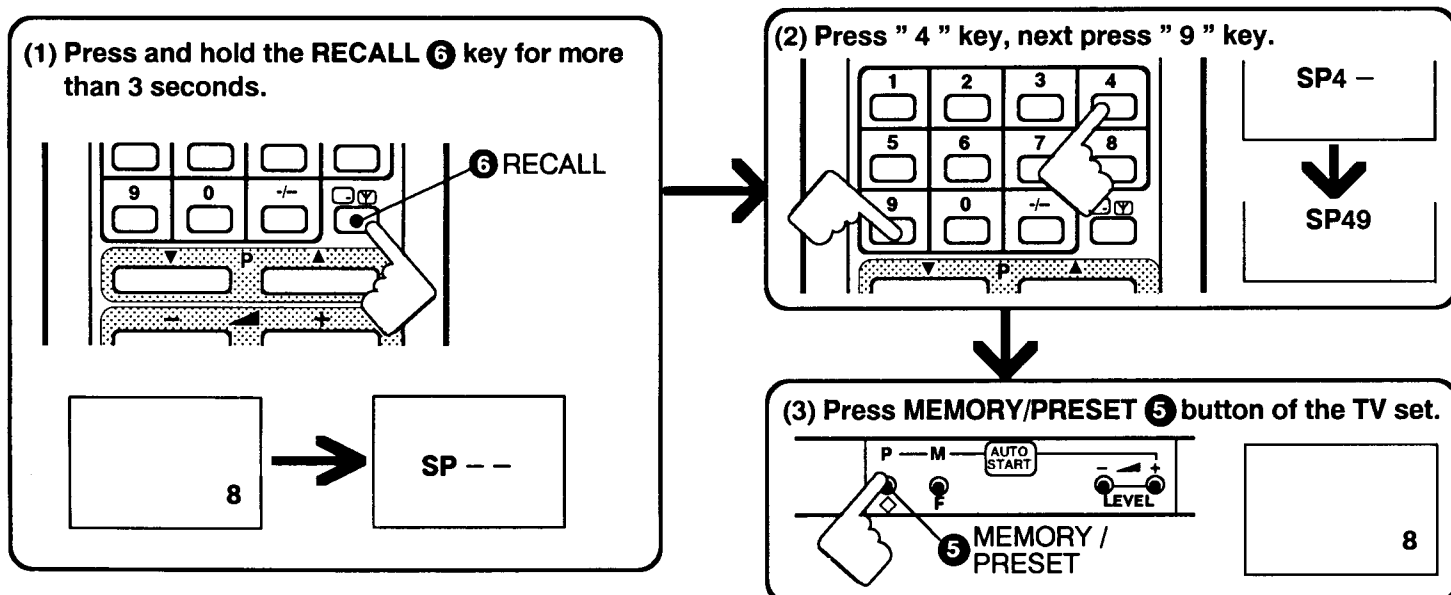

Special Functions

SP00 and SP01 (Reset all special functions)

- When "SP01" is input, all special functions are reset.
- When "SP00" is input, all special functions are cancelled, and the start condition for TV power is changed to the standby start condition, meaning that the picture will not appear even when the mains ON/OFF switch ① is set at the on position. To turn on the TV set from the standby mode, press the Power ON/OFF ①-1, Programme UP/DOWN ② or Programme Selector ②-1 key.

SP 31 (Maximum volume level setting and suppression of channel tuning function)

"SP31" is used to set a limit for the maximum volume level while keeping the current preset programme position in memory.

When "SP31" is entered, the volume output at the time of entering the code is placed in the memory as the maximum volume level. In other words, with this code it is possible to set the maximum volume at your preference. Entering this code automatically suppresses the preset function, so that even if the preset button is pressed, the preset mode will remain inactive.

(1) Set the desirable volume level using the LEVEL ③ key.

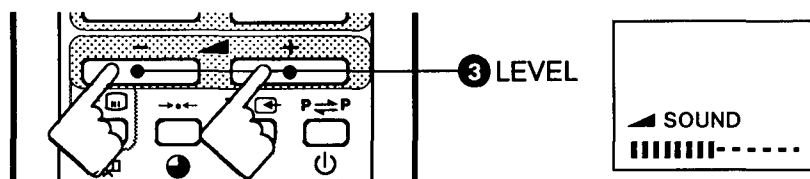

The volume level set in this procedure will be memorized as the maximum volume level.

(2) Input "SP31".

To cancell "SP 31", input "SP 30".

SP50 and 51 (Change of the start condition for the TV power)

When "SP 50" is entered, the start condition of the TV power is set to the standby start condition, meaning that the picture will not appear even when the Mains ON/OFF switch ① is set at the on position (The TV set remains in standby mode).

To return the TV's power start condition to its original condition (normal start condition), input "SP51".

SP60 and SP61 (Suppression of the auto shut off function)

When "SP 61" is entered, the auto shut off function is suppressed.

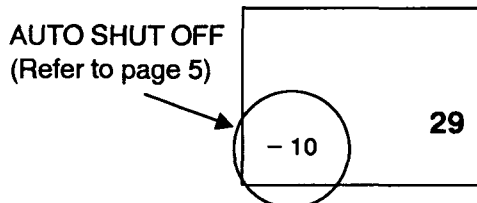

To cancell "SP61", input "SP60".

Special Functions

SP40 —SP49 (Start condition for TV programme)

These functions can be used to change the start up condition of the TV set as follows;

When "SP40" Is Input

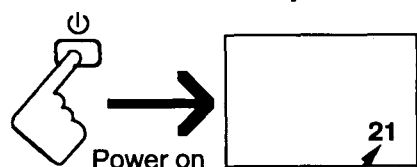

Power on

Previous programme position

The previously viewed programme position is always selected.

When "SP41" Is Input

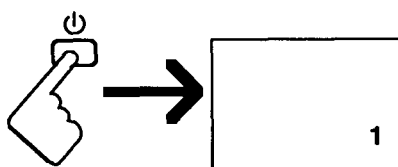

The TV will always switch on in programme position 1.

When "SP42" Is Input

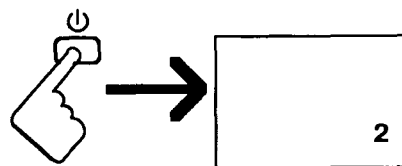

The TV will always switch on in programme position 2.

"SP43"

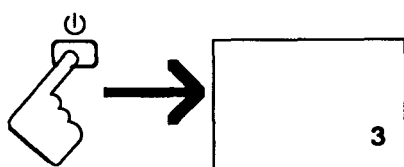

"SP44"

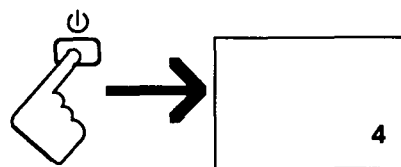

"SP45"

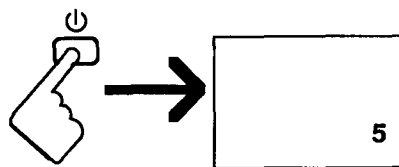

"SP46"

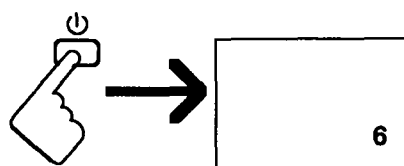

"SP47"

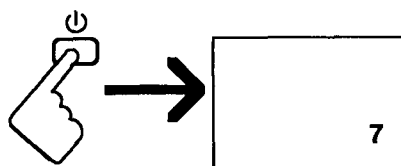

"SP48"

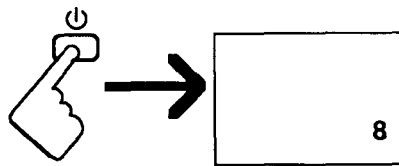

"SP49"

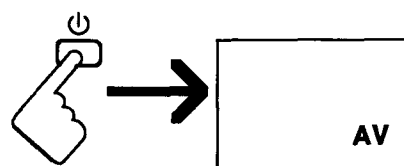

The TV will always switch on in AV mode.

Tuning of the Channels

Up to 30 broadcast stations in your reception area can be stored in the electronic memory.

There are three ways of tuning as follows;

Automatic Tuning (the basic way)

All receivable channels are automatically tuned in and memorized in consecutive programme position.

Search Tuning

Use to preset a receivable channel in any desired programme position, e.g. the position with the same number as the channel.

Manual Tuning

Manually tune a channel if it cannot be automatically tuned, such as when the signal is poor.

Automatic Tuning

(1) Press the MEMORY/PRESET button **5**.

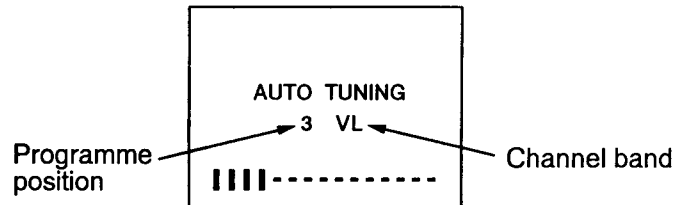
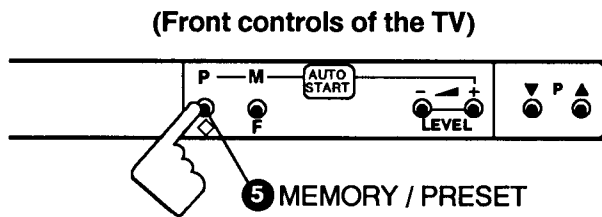

(2) Press the LEVEL(+) **3** button.

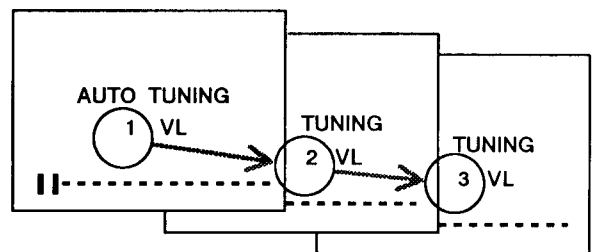
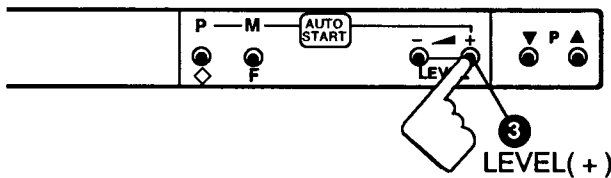

The channels are preset in consecutive positions beginning from the programme position "1".

After all available channels have been preset, the unit returns to the position "1".

Note: To cancel automatic tuning midway, press the MEMORY/PRESET **5** or Power ON/OFF **1-1** button.

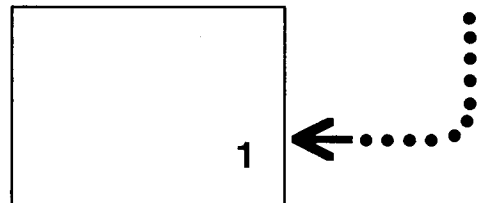

Channel Copy

Example: To copy the TV channel in the programme position 2 into the programme position 6

(1) Select programme position 2 using Programme selector **2-1**.

(2) Press the MEMORY/PRESET button **5** 3 times.

(3) Select the programme position 6 using Programme UP/DOWN **2** button of the TV set.

(4) Press FUNCTION button **4**.

(5) Press the MEMORY/PRESET button **5**.

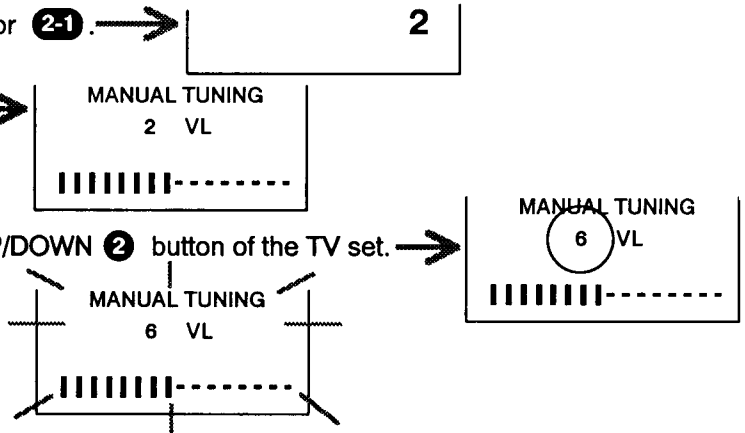

Tuning of the Channels

Search Tuning & Manual Tuning

Example: To preset a channel in programme position 6

Search Tuning

Manual Tuning

(1) Select programme position 6 using Programme selector **2-1**.

6

(2) Press the MEMORY/PRESET button **5** twice.

SEARCH TUNING

6 VL

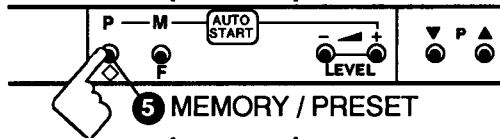

(2) Press the MEMORY/PRESET button **5** 3 times.

MANUAL TUNING

6 VL



(3) Press the LEVEL(+) or (-) **3** button.

SEARCH TUNING

6 VL



When a station is found, searching stops automatically.

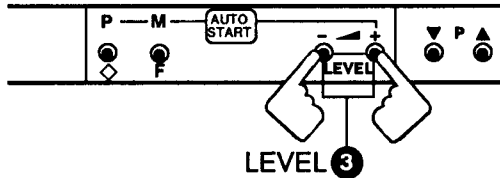

(3) Press and hold the LEVEL(+) or (-) **3** button until the desired station appears.

MANUAL TUNING

6 VL



(4) Press the FUNCTION button **4** of the TV set.

SEARCH TUNING

6 VL

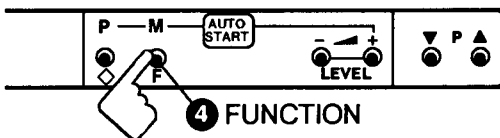

MANUAL TUNING

6 VL



(5) Press the MEMORY/PRESET button **5** twice.

6

This completes the presetting.

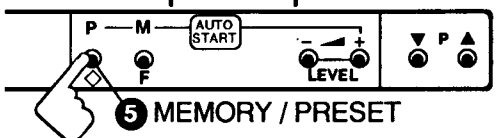

(5) Press the MEMORY/PRESET button **5**.

6

This completes the presetting.

Repeat steps 1 to 5 for other desired channels.

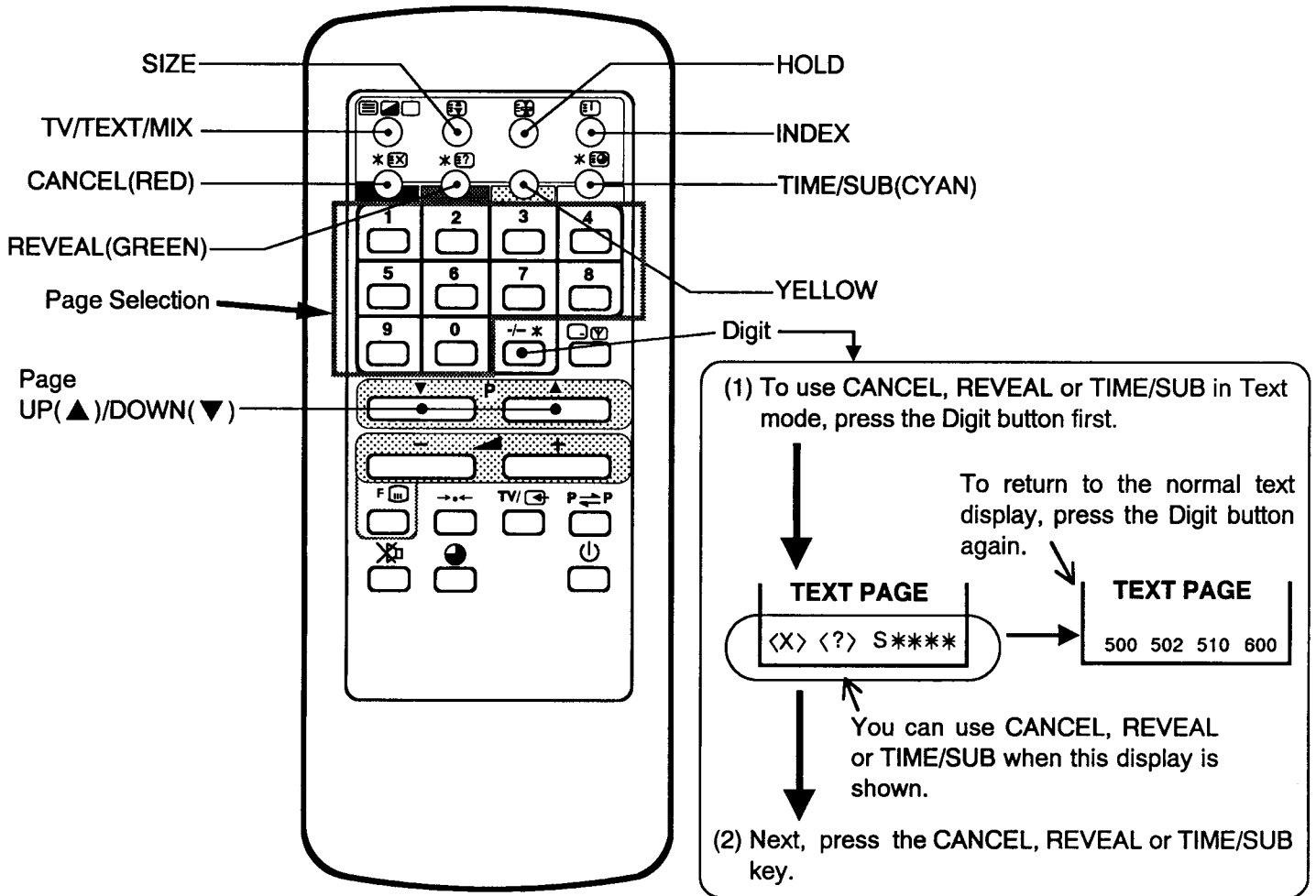

Switching to the Teletext mode

Press the TV/TEXT/MIX button, and the screen changes as follows:

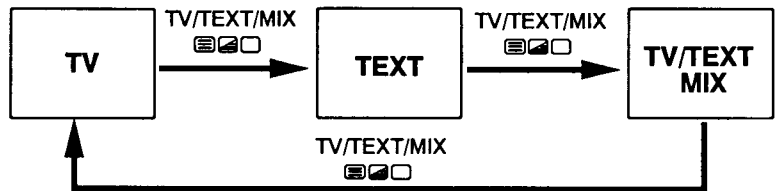
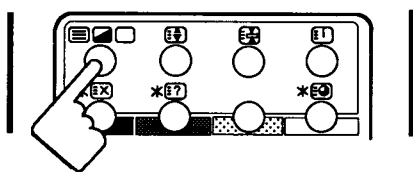

Page Selection

Direct Page Access

A Teletext page can be selected with the "0" to "9" buttons.

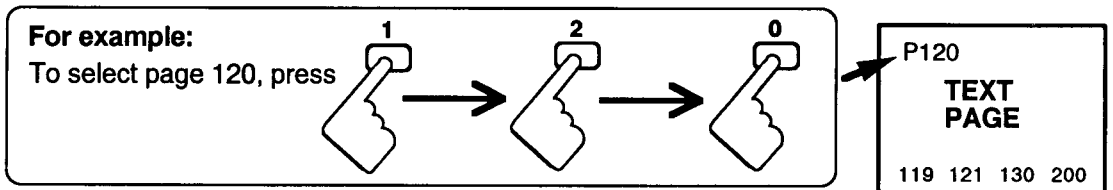

UP-DOWN Page Access

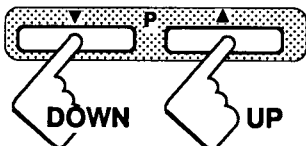

Press the Page UP (▲) button to step up to the next higher Teletext page.
Press the Page DOWN (▼) button to step down to the next lower Teletext page.

To display the Index Page

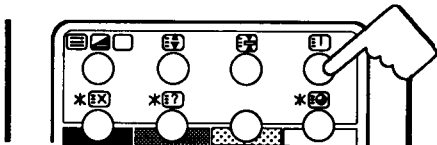

To return to the index page, press the INDEX button

Teletext Use

■ Sub-Coded Page Access

When a Teletext information page exceeds more than one screen of information, it may take some time for the automatic changing of the sub-pages to reach the sub-page you require.

It is possible to enter your required sub-page and continue watching the normal programme until the correct sub-page is found.

- (1) Select a text page which has sub pages.
- (2) Press the Digit button.

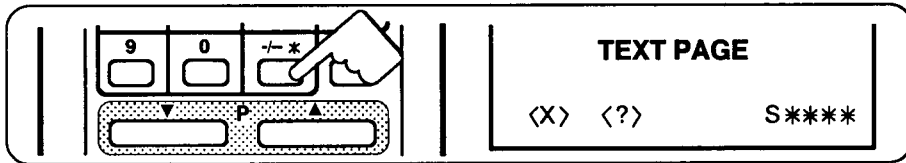

- (3) Press the TIME/SUB button.



To go back to normal Teletext page entry mode, press the Digit button again.

- (4) Enter the desired sub-page.

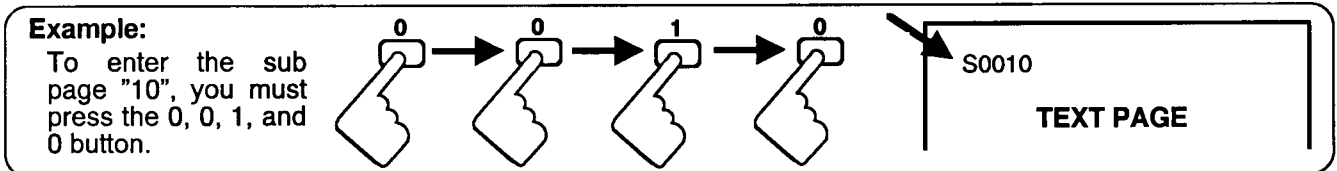

- (5) Press the CANCEL button.

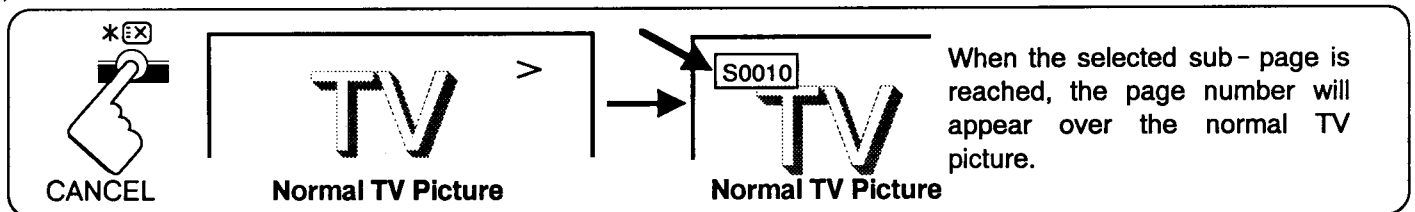

- (6) Press the TV/TEXT/MIX button to display the received sub-page.

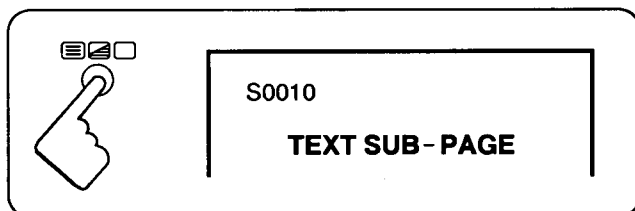

Note:

To clear the sub-coded page, enter a new page number.

It is not possible to select another television station during a sub-page access operation.

■ Viewing TV while searching for a page

In some cases it can take some time to look for a page. In the interval you can view the TV by pressing the Digit and CANCEL button.

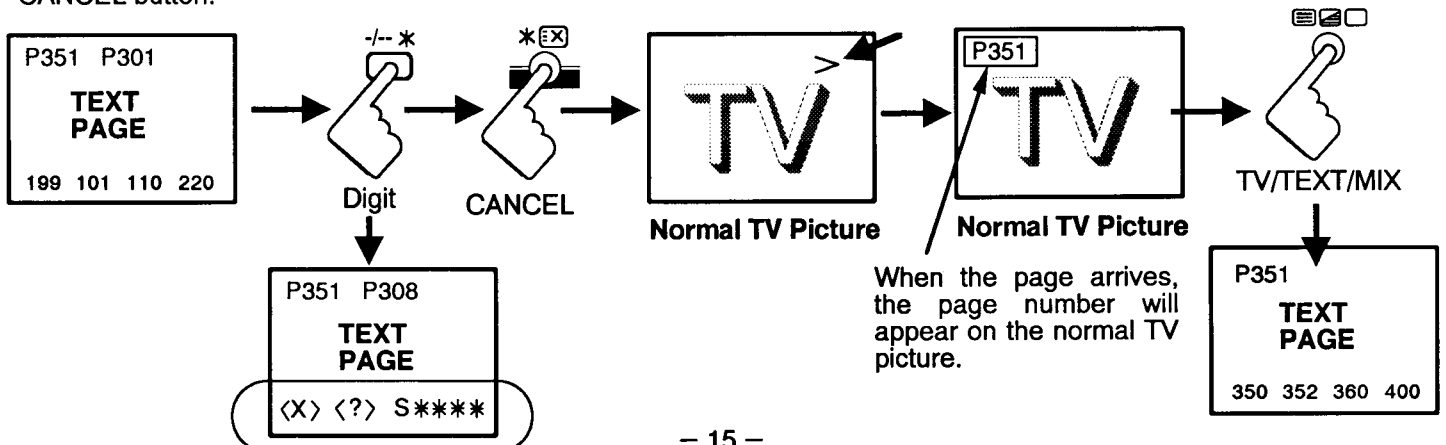

Teletext Use

■ HOLD

When a text page has sub - pages, you can prevent the sub page being automatically changed by pressing the HOLD button. Press the HOLD button again to resume page change or enter a new page number.

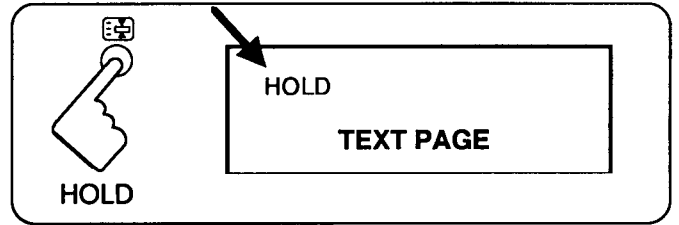

■ Double letter height

Either the top or bottom half of the display can be expanded by pressing the SIZE button.

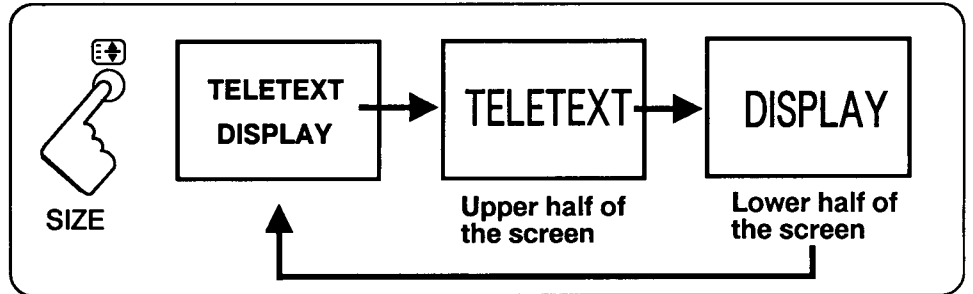

■ Displaying concealed information

Some of the text pages are in the form of a quiz or puzzle. The answer to these can be revealed by pressing the Digit and REVEAL button.

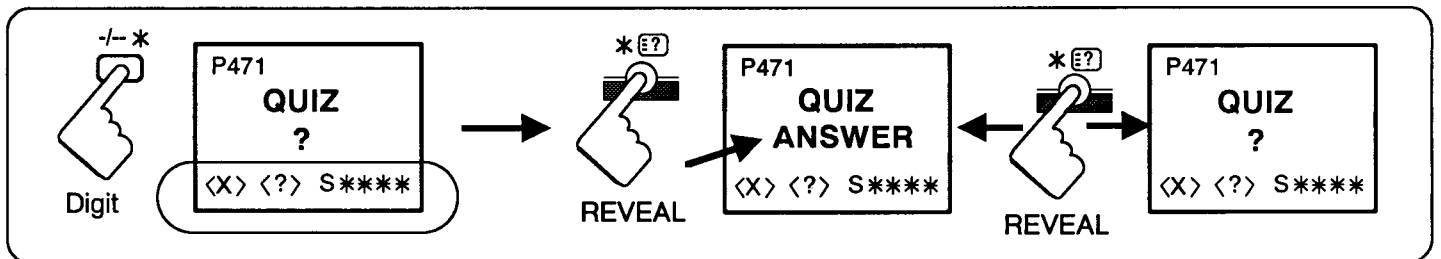

■ News flash

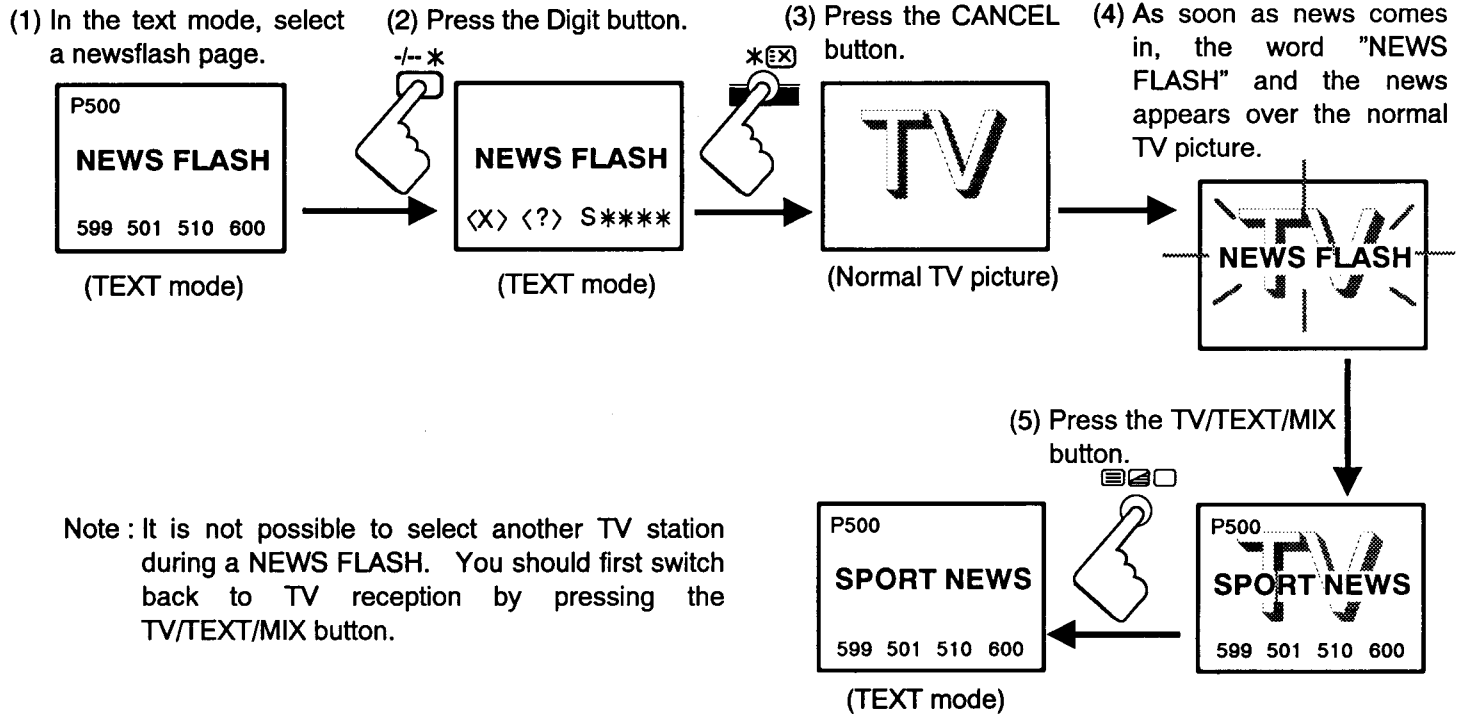

Note : It is not possible to select another TV station during a NEWS FLASH. You should first switch back to TV reception by pressing the TV/TEXT/MIX button.

Teletext Use

■ Updated Page

There are pages which are updated as events progress, such as sports results, news reports and traffic information.

If you have selected one of the above pages from the list of contents and you want to view television but still be kept informed about the other events;

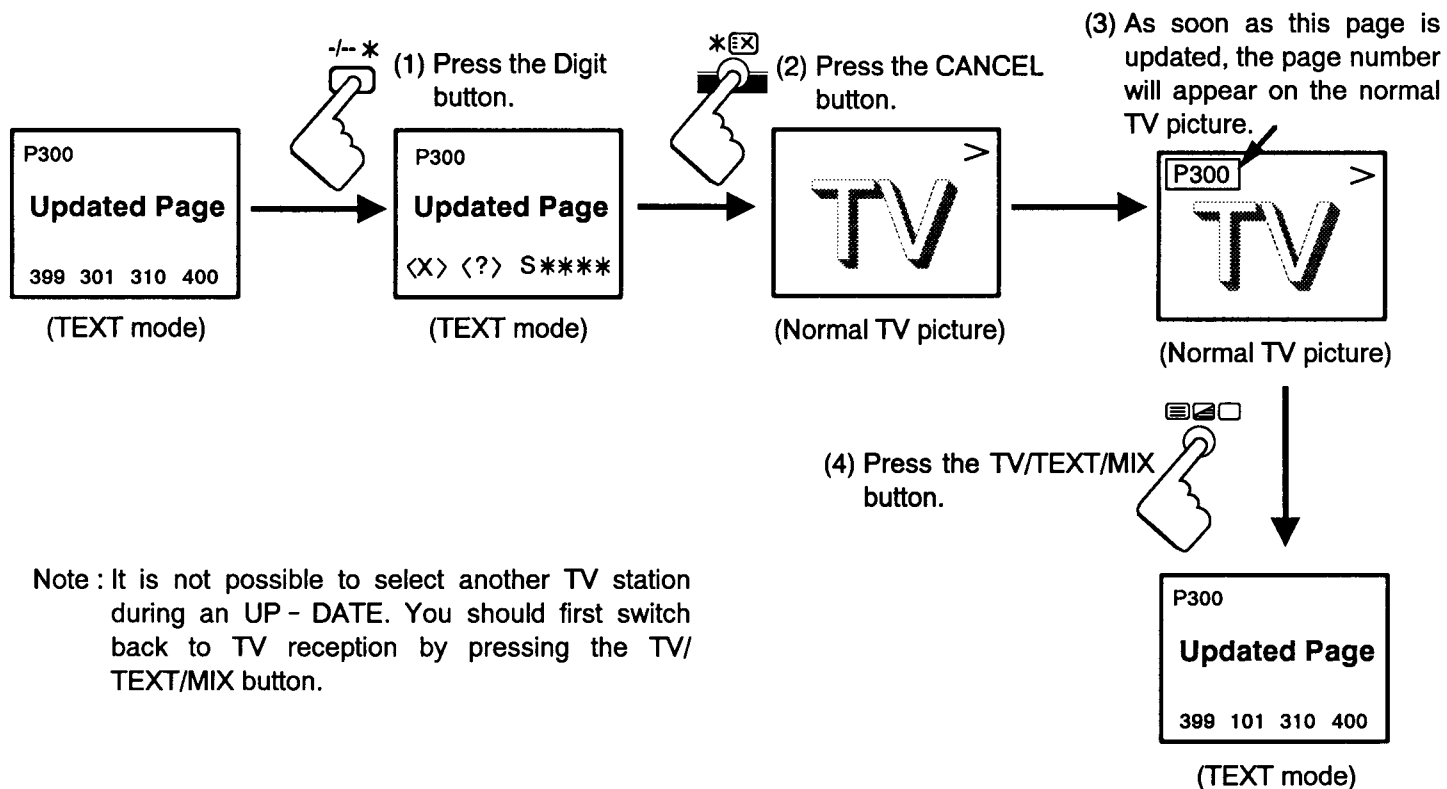

■ TIME *E

If the time is required while a programme is being viewed, press the TIME/SUB *E button.

Providing that the channel being viewed is also transmitting teletext, the time will appear at the top righthand of the screen for five seconds. The digits displayed represent hours/minutes/seconds.

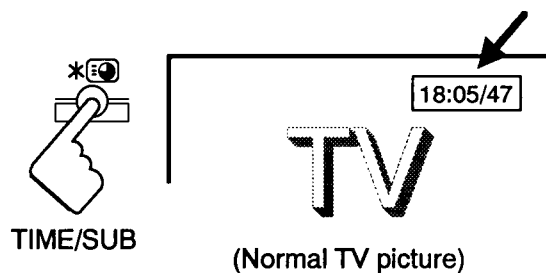

Teletext Use

■ FLOF (FLOF: Full-level -one feature)

When a broadcasting station provides FLOF service, you can access the text pages you desire quickly and easily.

In the FLOF mode, four Fastext topics are displayed at the bottom of the screen. These can be selected by pressing the corresponding coloured button (Red, Green, Yellow, Cyan) on the remote control transmitter. For example, when the Red button is pressed, the topic written in red is selected.

To get back to the initial index page, press the INDEX button.

(FLOF mode)

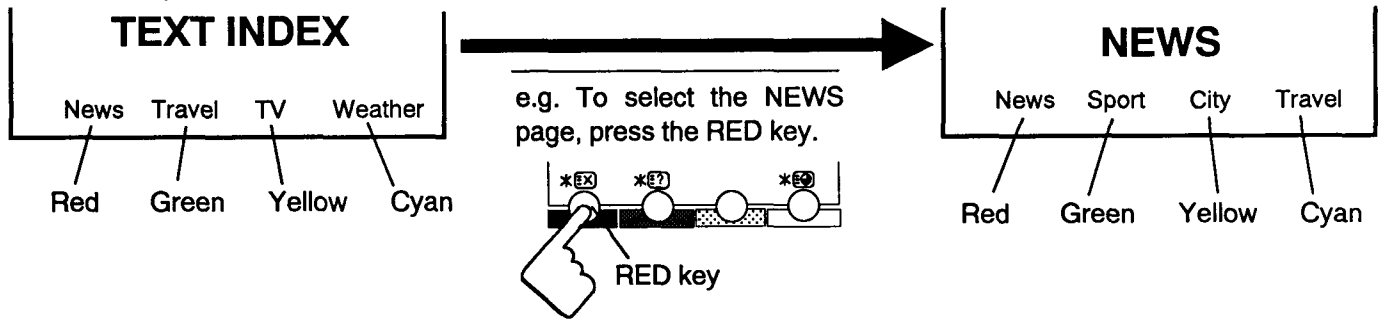

■ Non FLOF Service

When the station does not have FLOF service, the INDEX page (P100) is automatically displayed. At the bottom of the screen, the four page numbers 199, 101, 110, 200 are also displayed. Then, when you select a random page number out of the displayed four pages by pressing a colour button, the text of that page is displayed.

Of course at any time you can select new pages by inputting new numbers.

(Non FLOF mode)

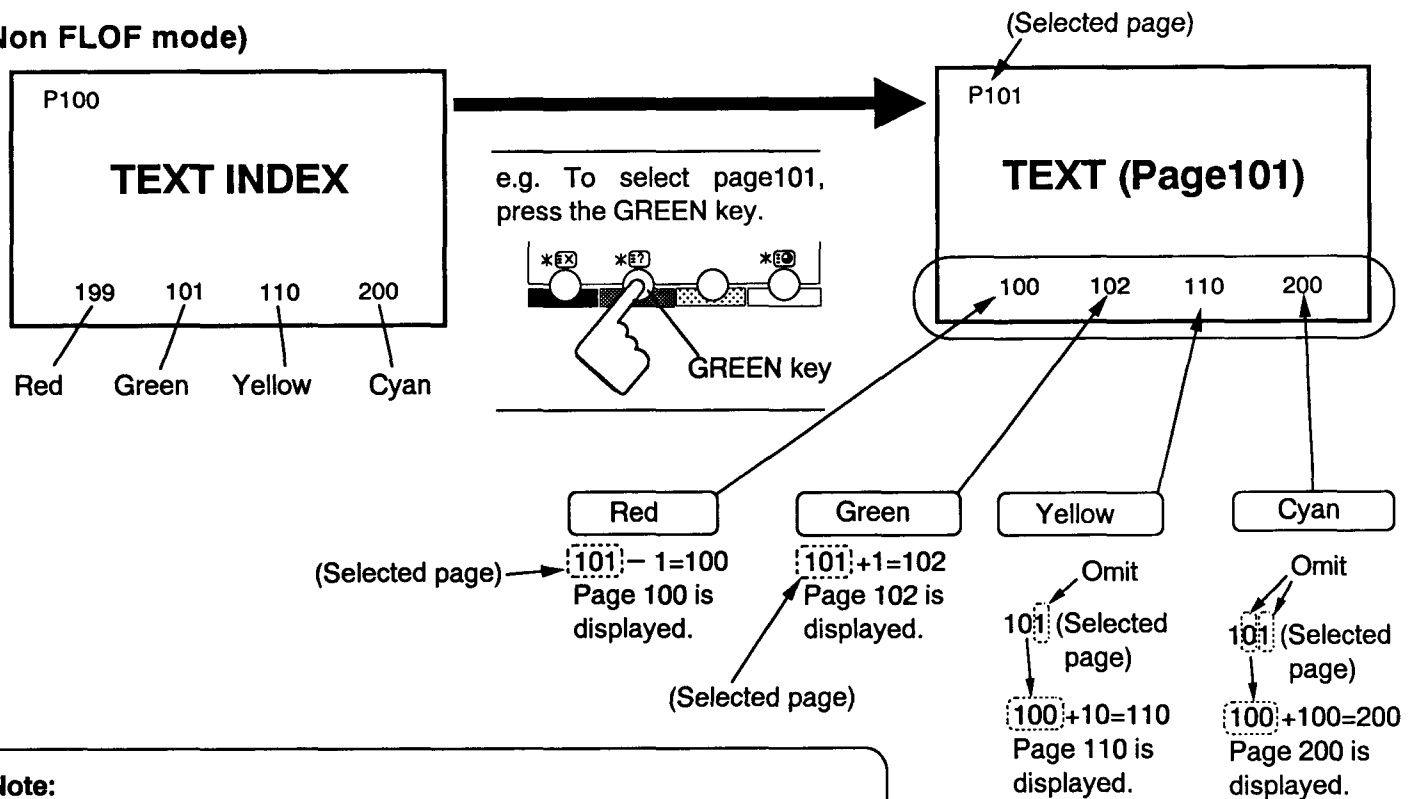

Note:

If your aerial signal is poor, the teletext reception may be poor.

Connecting other Equipment

Connecting to the AV input jacks

(A/V Terminal)

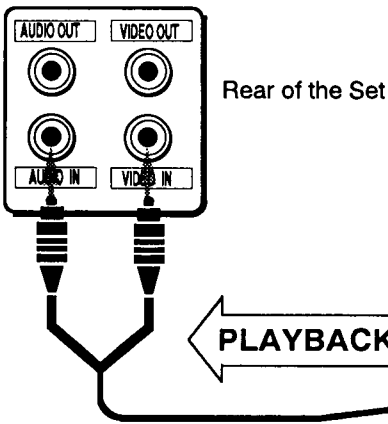

Connect the video and audio outputs of a VCR, video disc player, etc. to the input jacks of this TV set. Tapes and discs can be played back.

VIDEO/AUDIO Input level

	Level	Impedance
VIDEO INPUT	1.0Vp-p	75 Ω
AUDIO INPUT	436mVrms	More than 40K Ω

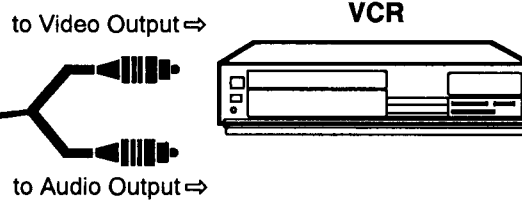

To watch the video input picture

(1) Press the TV/AV Selector **11**.

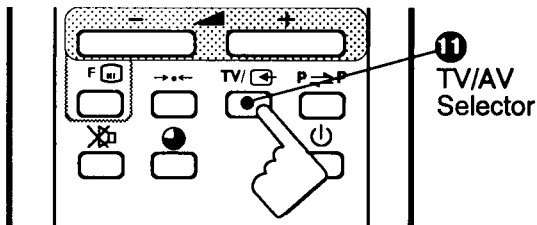

(2) Set the VCR to playback mode.

To return to the TV mode;

Press the TV/AV Selector again.

Connecting to the AV output jacks

(A/V Terminal)

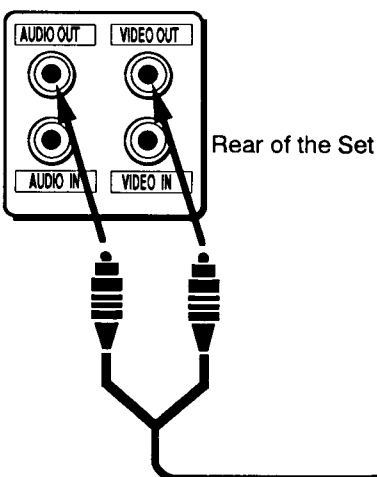

The AV output terminal provides audio and video output for TV broadcasts being received. They are used to record TV broadcasts.

To record TV broadcasts, Select the TV mode using TV/AV Selector **11**.

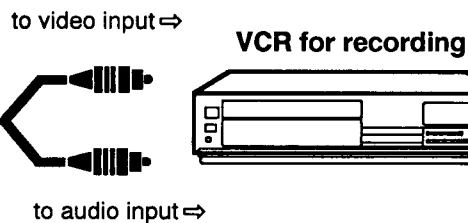

VIDEO/AUDIO output level

	Level	Impedance
VIDEO OUTPUT	1.0Vp-p	75 Ω
AUDIO OUTPUT	436mVrms	Less than 600 Ω

Connecting other Equipment

To record a TV broadcast while watching the playback from a VCR

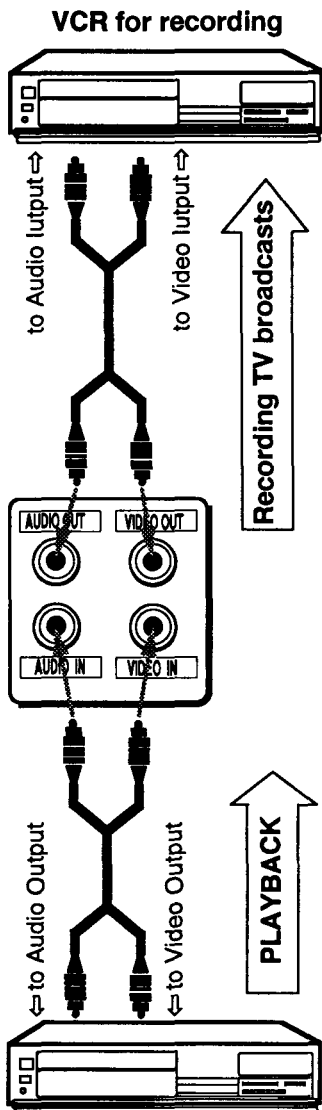

Example: To record a TV broadcast of programme position " 7 " while watching the playback from a VCR,

- (1) Press the TV/AV Selector **1** , and set the VCR to playback mode.

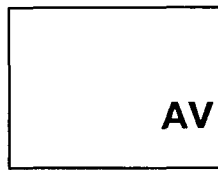

- (2) Press " 7 " key of the Programme Selector **2-1** .

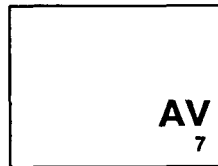

- (3) Set the VCR for recording to the recording mode.

AV connection to the aerial socket

The AV apparatus can also be connected to the aerial socket of your TV receiver.

Presetting to watch the video input

- (1) Play back the VCR.
- (2) Tune a channel in programme position 0 (See Search tuning & Manual tuning on page 14).

Watching the video input

Select programme position 0.

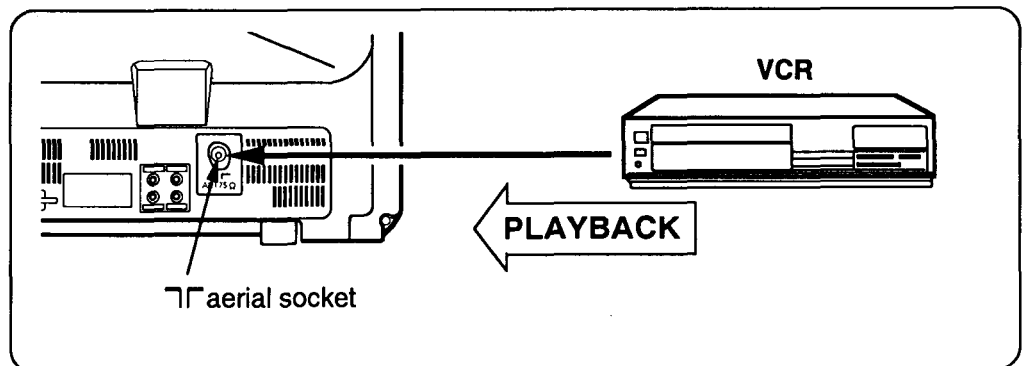
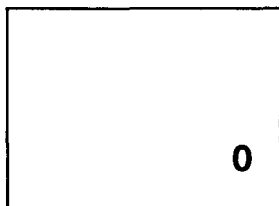

For further details concerning this connection and adjustment, refer to the operating instructions for the AV equipment.

Specifications

Power source AC 220- 240 Volts, 50Hz.

Receiving system PAL- B/G

Channel coverage Model C20PE70, C21PM40, C21PM45

VHF: 0- 11, 5A

UHF: 28- 69

Model C20ZE70, C21ZM40, C21ZM45

VHF: 1- 11

UHF: 21- 69

Aerial input impedance 75 Ω

Audio output (Music) 3.5W

Ext. terminals

AV Inputs:

Video input(Phono jack) x 1

Audio input(Phono jack) x 1

AV Outputs:

Video output(Phono jack) x 1

Audio output(Phono jack) x 1

Headphone jack(Mini jack) x 1

Dimensions

C20PE70, C20ZE70: 494(W) x 442(H) x 472(D)mm

C21PM40, C21PM45, C21ZM40, C21ZM45: 501(W) x 470.4(H) x 485(D)mm

Weight

C20PE70, C20ZE70:

C21PM40, C21PM45, C21ZM40, C21ZM45: approx. 20.5 Kg

Specifications subject to change without notice.

Battery installation of the Remote Control Transmitter

- 1 Remove the battery cover by sliding.
- 2 Install two "AA" 1.5 volt batteries so that the "+" and "-" marks on the batteries match the "+" and "-" marks inside the unit.
- 3 Close the battery cover.

Note: Replace the batteries when the TV set is showing the following symptoms:

Operation is unsteady or erratic, sometimes the TV set does not work with transmitter.

Discharged batteries may leak and damage the unit.

The normal life of batteries should be from nine to ten months.

Part No. 1AA6P1P0473-- E8RZ (A7-A)

SANYO

SANYO ELECTRIC Co., Ltd