

SANYO

INSTRUCTION MANUAL

CDP-990

Compact Disc Player

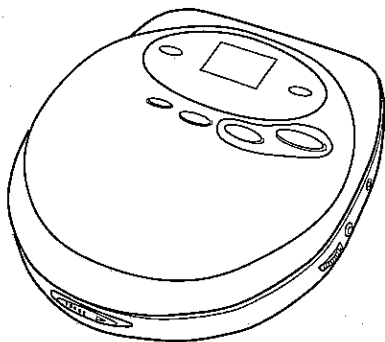

PRECAUTIONS

CAUTION

USE OF CONTROLS OR ADJUSTMENT OR PERFORMANCE OF PROCEDURES OTHER THAN THOSE SPECIFIED HEREIN MAY RESULT IN HAZARDOUS RADIATION EXPOSURE.

THIS PRODUCT SHOULD NOT BE ADJUSTED OR REPAIRED BY ANYONE EXCEPT QUALIFIED SERVICE PERSONNEL.

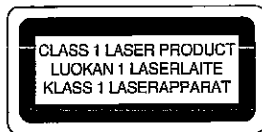
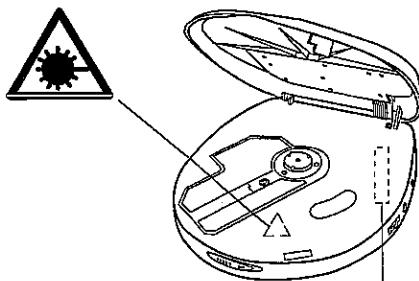

CAUTION – INVISIBLE LASER RADIATION WHEN OPEN AND INTERLOCKS DEFEATED. AVOID EXPOSURE TO BEAM.

ADVARSEL – USYNLIG LASER STRÅLING VED ÅBNING, NÅR SIKKERHEDSafbrydere er ude af funktion, undgå udsættelse for stråling.

VARNING – OSYNLIG LASER STRÅLNING NÅR DENNA DEL ÄR ÖPPNAD OCH SPÄRR ÄR URKOPPLAD. STRÅLEN ÄR FARLIG.

VORSICHT – UNSICHTBARE LASERSTRAHLUNG TRITTS AUS, WENN DECKEL GEÖFFNET UND WENN SICHERHEITSVERRIEGELUNG ÜBERBRÜCKT IST. NICHT, DEM STRAHL AUSSETZEN.

VARO – AVATTAESSA JASUQVALUKTUOSHITETTAESSAOLETALTTIINA NÄKYMÄTTÖMÄLLE LASERSÄTEILYLLE. ÄLÄ KATSO SÄTEESEEN.

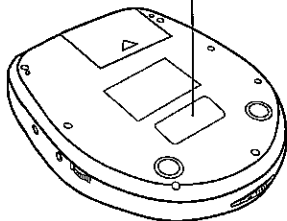

- High volume levels can create potentially dangerous situations by drowning out surrounding sounds. Use caution when driving while operating the unit, and obey all applicable laws. Do not play your headset at a high volume level. Hearing experts advise against continuous extended play. If you experience a ringing in your ears, reduce the volume or discontinue use.
- No objects filled with liquids, such as vases, shall be placed on the apparatus.
- Do not use while bicycling, running or operating a motorized vehicle.
- The rating label is located on the bottom of the unit.
- The apparatus shall not be exposed to dripping or splashing.
- Do not use where there are extremes of temperature (below 5°C or exceeding 35°C).
- Sudden changes in the ambient temperature may cause condensation to form on the optical lens inside the unit. If this happens, take out the disc, leave the unit for about 1 hour, and then proceed to operate.
- Do not insert pins, etc., inside the unit.
This unit is equipped with a safety device which automatically turns the laser beam off when the disc compartment is opened. If a pin or other metal object should get inside the unit, however, this safety device may be deactivated.

CONTROLS

1. Disc compartment
2. Stop button (■)
3. Fast forward button (▶▶)
4. Rewind button (◀◀)
5. Programme button (PROGRAM)
6. Display
7. Play mode button (PLAYMODE)
8. Play/Pause button (▶/||)
9. External DC socket (DCIN)
10. Headphones socket (PHONES)
11. Volume control (VOLUME)
12. Open switch (OPEN)

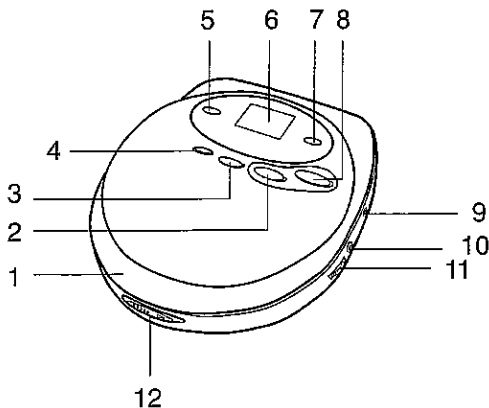

POWER SUPPLY

AC adaptor

Plug one end of the AC adaptor into the DC IN socket, then plug the other end into an AC outlet.

- Use only the supplied AC adaptor.
- If the AC adaptor is connected. The power supply automatically switches to the AC power source and the installed batteries are disconnected.

Batteries

Install two "AA" batteries (not supplied) as shown below. Observe proper polarity.

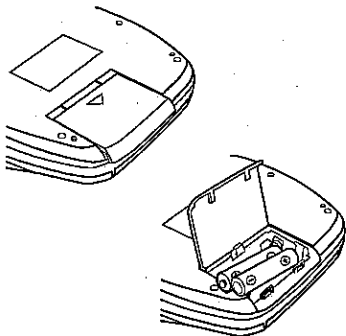

Battery replacement

If the batteries are weak and discharged, "  " appears on the display. Then the power automatically turns off. If this occurs, replace the batteries.

- Dispose of all used batteries safely and in accordance with all applicable laws.

Note:

When you are not going to use the unit for one month or more, take the batteries out of the battery compartment.

BEFORE OPERATION

Auto power on function

The power turns on automatically when the ►/|| button is pressed.

Auto power off function

The power turns off automatically after about 30 seconds when all tracks on a disc have been played or when the ■ button is pressed once to stop play.

If the operating buttons do not function when pressed ...

1. Remove the batteries and/or disconnect the AC adaptor from the unit. Wait a few seconds, then reinstall the batteries or reconnect the AC adaptor.
2. If the buttons still do not function, insert new batteries.

HANDLING COMPACT DISCS

Use compact discs bearing the symbol shown below. In addition to conventional 12 cm CDs, this unit can be used to play 8 cm CDs without an adaptor.



- Do not expose the disc to direct sunlight, high humidity or high temperatures for extended periods of time.
- Discs should be returned to their cases after use.
- Do not apply paper or write anything on the disc surface.

- Handle the disc by its edge. Do not touch the playing surface (glossy side).
- Fingerprints and dust should be carefully wiped off the playing surface of the disc with a soft cloth. Wipe in a straight motion from the center to the outside of the disc.
- Never use chemicals such as record cleaning sprays, antistatic sprays or fluids, benzene or thinner to clean compact discs.

The unit will not play a disc that has been inserted upside down, or discs which do not conform to the Compact Disc standard.

PLAYING A DISC

- Be sure to reduce the volume before connecting or disconnecting the headphones.

BASIC CD PLAY

1. Connect the headphones to the PHONES socket.

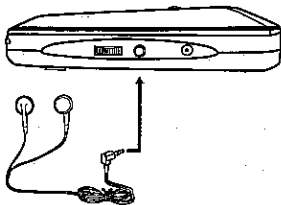

2. Slide the OPEN switch right to open the disc compartment lid.
3. Hold the disc with the labeled side up and press it onto the pivot until it "clicks" into place.

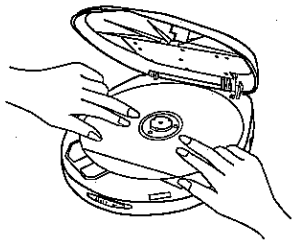

WARNING!

Do not insert your fingers into the opened panel. You may damage the unit or cause personal injury.

Do not allow young children to operate the unit unattended.

To remove the disc

Remove the disc while pressing the pivot.

4. Close the disc compartment lid.

5. Press the ►/|| button to begin play.

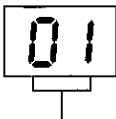

Track number

The track number for the current track are displayed.

6. Adjust the VOLUME control as desired.
7. To stop play temporarily, press the ►/|| button. The display blinks. Press the ►/|| button again to resume.
8. To stop play, press the ■ button once. The total number of tracks time appear.
 - To turn the power off, press the ■ button once again.

Skip play

To skip to track 6 while track 3 is playing, press the ►| button repeatedly until "06" appears on the display.

To skip back to track 3 while track 6 is playing, press the |◀◀ button repeatedly until "03" appears.

Search (forward/reverse)

If the ►►| or |◀◀ button is pressed during play, the player will search at high speed in the forward or reverse direction while the button is being pressed. When the button is released, normal play will continue.

PROGRAMMED PLAY

Up to 24 tracks on a disc can be programmed for play in any order.

1. Press the PROGRAM button during stop.

Programme number

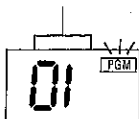

2. Press the ►► or ◀◀ button to select a track.

Track number



3. Press the PROGRAM button.

Programme number

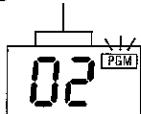

4. Repeat steps 2 and 3 to programme tracks.
5. To check the programme contents after all tracks have been programmed, press the PROGRAM button repeatedly. The programmed track numbers sequentially appear on the display.

6. Press the ►/II button to start programmed play.



- To cancel programmed play, press the ■ button twice.

Changing a programme

To add a new track to a programme:

1. In the stop mode, press the PROGRAM button repeatedly until the programmed track number behind the last one is displayed.
2. Select a track as explained above.
3. Press the PROGRAM button.

To change a track:

1. In the stop mode, press the PROGRAM button repeatedly until the track number to be replaced is displayed.
2. Select a track as explained above.
3. Press the PROGRAM button.

Note:

- Programmed details cannot be partially deleted or inserted.
- The programmes will be lost after turn off the power or the disc compartment is opened.

VARIOUS PLAYING MODE

Press the PLAYMODE button repeatedly during stop to select a various play mode available. Each time the button is pressed, the mode changes as shown below:

Repeat one (CD) → Repeat all (ALLCD) → Random play (RAND) → Released

- During programmed play mode, "RAND" (random play) can not be selected.

Once the desired play mode is displayed, press the ►/|| button to begin play in that mode.

REPEAT PLAY

You can play tracks repeatedly in normal or programmed play modes.

Single track repeat

Press the PLAYMODE button once during stop or play. "CD" appears on the display.

All tracks repeat

Press the PLAYMODE button twice during stop or play. "ALLCD" appears.

- To cancel repeat play, press the PLAYMODE button repeatedly until "CD" or "ALLCD" is disappeared.

RANDOM PLAY

1. Press the PLAYMODE button three times during stop or play. "RAND" blinks.
2. Press the ►/|| button. All tracks on the disc are played in random order.
 - To cancel random play, press the PLAYMODE button once.

CLEANING

Cleaning the pickup lens

Dust on the pickup lens can lead to erratic operation and interruption of the sound during play.

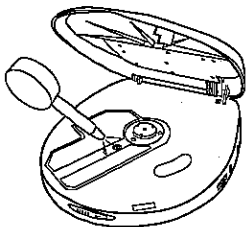

- To clean the pickup lens, open the disc compartment lid. Blow the dust off of the lens using a camera lens blower (available at most camera stores).
- Do not touch the surface of the lens.

Cleaning the cabinet

Use a soft cloth moistened with plain lukewarm water and wrung dry. Never use benzol, benzene or other strong chemical cleaners.

SPECIFICATIONS

Channels:	2 channels
S/N ratio:	60 dB
Wow and flutter:	undetectable
Sampling frequency:	44.1 kHz
Pickup light source:	Semiconductor laser
Pickup wave length:	790 nm
Laser output:	0.5 mW (continuous wave max.)
Terminal impedance:	PHONES: 16 - 32 ohms
Power source:	DC: 4.5V (AC adaptor) AC adaptor: 230V ~ 240V, 50Hz DC: 3V (AA x 2)
Dimensions:	134 x 33 x 147 mm (W x H x D)
Weight:	Approx. 220g without batteries

Specifications subject to change without notice.



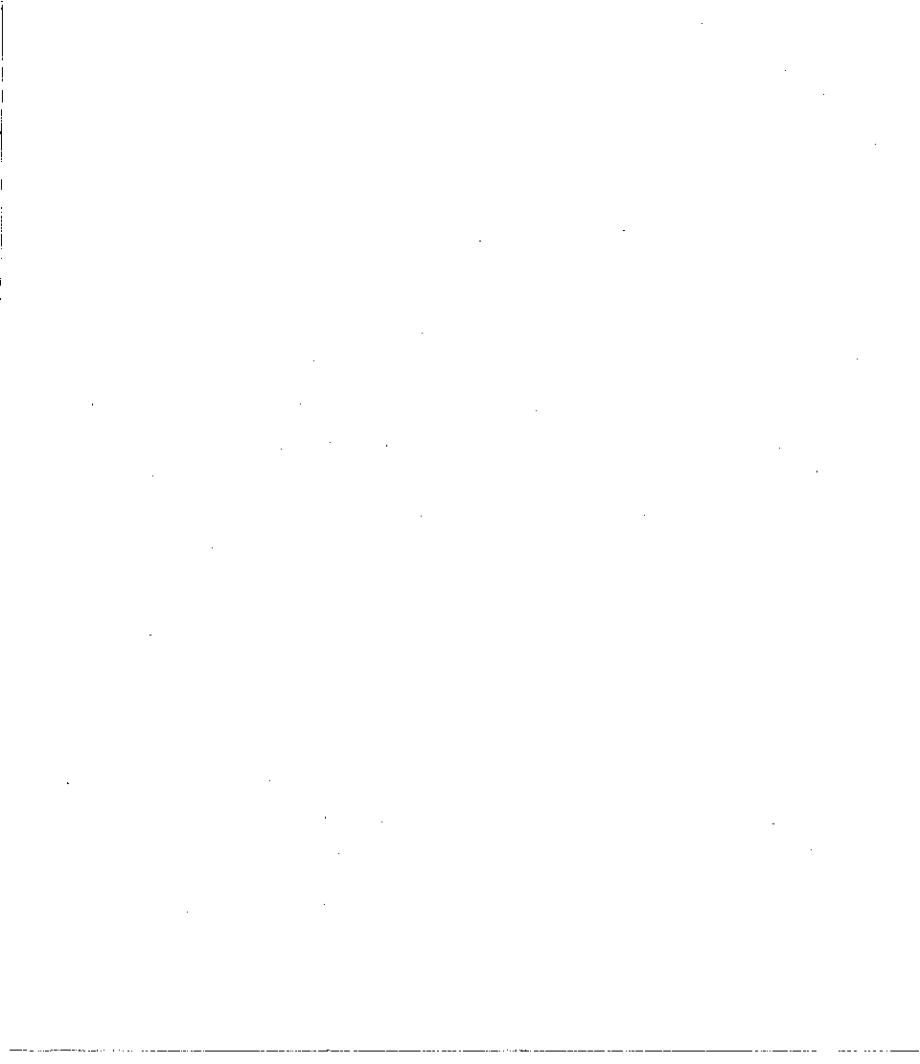

1AD6P1P1961--
(AU)

SANYO

SANYO Electric Co., Ltd.
Printed in China