

SANYO

INSTRUCTION MANUAL

CLA-837X

Cordless Telephone / Digital Answering System

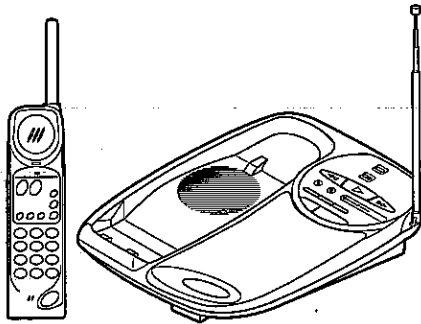

**Please read these instructions completely before use.
If you have a problem with your cordless telephone, please
see "TROUBLESHOOTING" on pages 52 and 53 before
calling for service.**

CAUTION

**THIS PRODUCT IS INTENDED FOR USE IN AUSTRALIA ONLY.
SALE OR USE IN OTHER COUNTRIES MAY VIOLATE LOCAL LAWS.**

IMPORTANT!

HANDSET BATTERY PACK

**Charge the handset battery pack for a full 12 hours before using
your cordless phone for the first time. (See pages 5 - 7.)**

RINGER SWITCH

**If the RINGER switch is set to the off position, no ring is heard when an incoming call is
received. (See pages 11 and 14.)**

TABLE OF CONTENTS

	PAGE
INTRODUCTION	2
UNPACKING	3
TIPS FOR BEST PERFORMANCE	4
INITIAL SETUP	
Installing the handset battery and initial charging	5
Connections	6
Dialing system	7
Charging the handset	7-8
Security code	8-9
Speaker volume control	9
NAMES OF CONTROLS	
Handset	10-11
Base station	12-14
CORDLESS TELEPHONE OPERATION	
Before using the phone	15
10-channel access/auto scan	15
Placing a call	16
Answering a call	17
Using the handset speakerphone	18-19
Speed dial	20-21
Redial	21
Instant tone	22
Flash button	22
Intercom	23-24
DIGITAL ANSWERING SYSTEM OPERATION	
Time/day voice clock	25-26
Ring delay/toll saver	27-28
CPC (Calling Party Control) switch	28
Recording an announcement	29-30
Before you leave	31-32
When a call comes in	33-34
When you come home	35-36
Other answering system features	36-38
Remote operation (from the handset)	38-42
Remote operation (from a touch-tone telephone)	43-47
MAINTENANCE	
AC power backup system	48-49
Wall mounting	49
Rechargeable handset battery	50
MALFUNCTIONS	51
TROUBLESHOOTING	52-53

INTRODUCTION

The Sanyo CLA-837X is a **SUPER COMPANDER** cordless telephone and an all-digital answering system in one compact unit.

The built-in answering system uses no tapes or mechanical parts. Your messages and announcements are digitally recorded on a flash memory chip that requires no memory backup system. All recordings are maintained until you erase or re-record them. The CLA-837X provides approximately 20 minutes total memory space for all recording.

Other answering system features:

■ **Private Mail Box**

- Instant skip to next or previous message
- All or individual message erase
- Date/time voice stamp (in English)
- Four announcements: 2 recordable + 2 pre-recorded in English
- Voice prompts
- Full-function remote access
- 100 remote access codes
- Memo recording
- Message indicator
- Call screening from handset or base station
- Adjustable ring delay (1 - 9) with toll saver option

Cordless telephone features:

- Handsfree speakerphone on handset
- 10-channel access/10 million digital security codes
- Illuminated handset keypad
- 30-day standby
- Intercom/2-way paging
- AC power backup system
- 10-number speed dial
- Extended operating range

Notice:

This cordless telephone uses radio communication between the handset and the base station and may not ensure privacy of communication. Other devices, including other cordless telephones, may interfere with the operation of this cordless telephone or cause noise during operation. Cordless telephones must not cause interference to any licensed radio service.

UNPACKING

Check to make sure you have all the items that come with the system.

Handset



Base Station

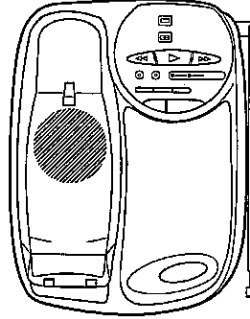

AC Adaptor

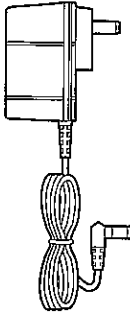

Telephone Cord

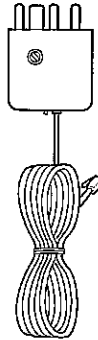

**Speed Dial
Directory labels**

SPEED DIAL	
M1	
M2	
M3	
M4	
M5	
M6	
M7	
M8	
M9	
M0	

SPEED DIAL	
M1	
M2	
M3	
M4	
M5	
M6	
M7	
M8	
M9	
M0	

Model No. KR0617 or AD-B176
INPUT: AC 230V~240V, 50Hz
OUTPUT: DC 9V, 350mA
Polarity: Center Negative



Battery Pack

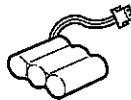

Wall Mount Bracket

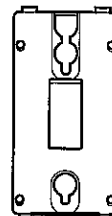

TIPS FOR BEST PERFORMANCE

BASE STATION LOCATION

For maximum operating range, extend the base station antenna to full length. In most cases, the best location for the base station is at the highest point in the house. Avoid places near electrical appliances and metal structures such as a refrigerator and filing cabinets that can reduce operating range and performance.

Away from electrical appliances such as a TV, radio, or personal computer.

In a HIGH and CENTRAL location with no obstructions.

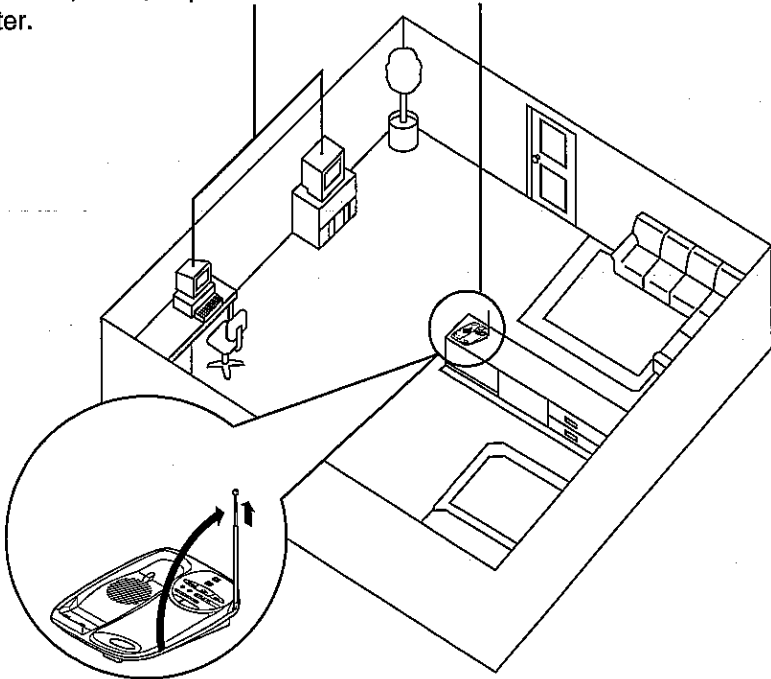

Do not place the base station on top of or near a TV or VCR as this may interfere with the performance of these appliances.

CAUTIONS:

- If you operate this product near water (bathtub, swimming pool, kitchen), take care to avoid contact between the water and the handset.
- Never spill liquid of any kind on the handset. This may cause a malfunction.
- Do not operate this product with dirty hands or allow the handset to be exposed to direct sunlight for extended periods. This can cause blurring, discoloration and fading of the lettering on the handset keypad. Discoloration or fading will have no effect on the telephone performance.
- Connect the AC adaptor to a wall outlet that receives power continuously. Do not connect it to a switched outlet.

INITIAL SETUP

INSTALLING THE HANDSET BATTERY AND INITIAL CHARGING

1. Remove the battery compartment lid.
2. Plug the battery cord into the connector inside the compartment.
3. Place the battery in the compartment.
4. Replace the lid.

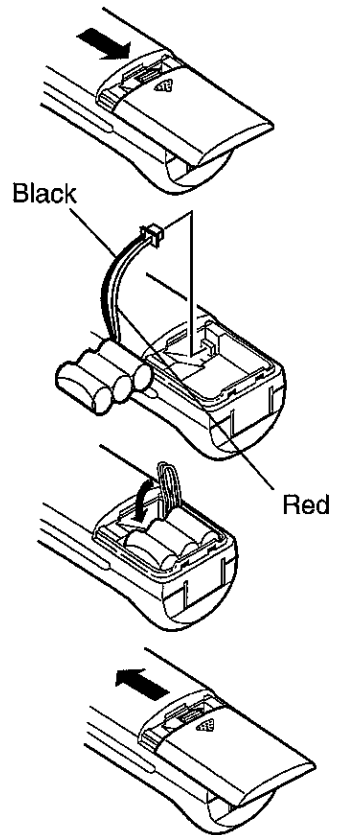

IMPORTANT: Charge the handset for a full 12 hours before using the cordless phone for the first time. Never attempt to use the cordless phone before this initial battery charge. See page 7.

Replacement battery number:
SANYO 3N-270AA or GP30AAK3BML
Use of other brands or types of batteries may cause serious damage or equipment malfunctions.

INITIAL SETUP (continued)

CONNECTIONS

1. Insert the small plug of the AC adaptor cord into the **DC 9V AC ADAPTOR** jack on the back of the base station.
2. Secure the AC adaptor cord under the hook located below the jack, as shown.
3. Plug the AC adaptor into an AC wall outlet.
4. Plug one end of the telephone cord into a telephone wall jack, and the other into the **TEL LINE** jack on the back of the base station.

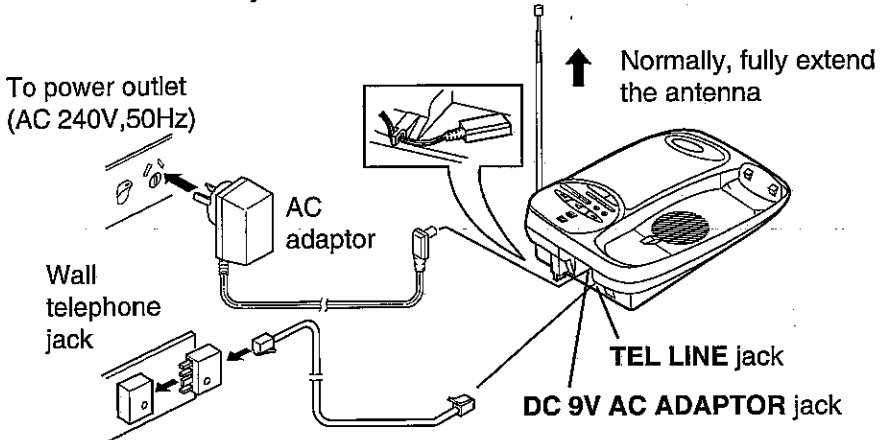

NOTE: USE ONLY SANYO AC ADAPTOR MODEL NO. KR0617 (APPROVAL NO. Q94113) or AD-B176 (APPROVAL NO. N16475)

If the plug of your Telecom telephone cannot be readily removed, you will have to remove the screw securing it. To do this proceed as follows:

1. Loosen screw "A" sufficiently to remove the socket cover.
2. Remove screw "B" and withdraw the plug.
3. Replace screw "B". Ensure that it screws completely into the socket recess. (If the screw is too long, increase the hole depth or replace the screw with one 5 mm shorter.)
4. Replace socket cover and tighten screw "A".

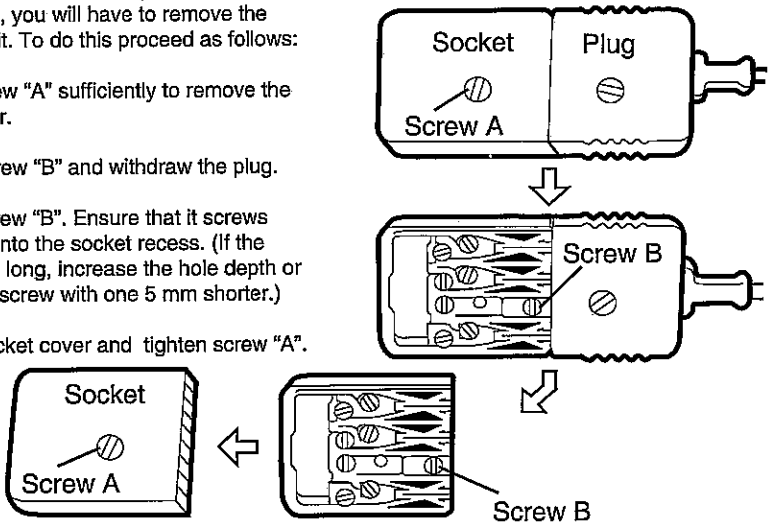

INITIAL SETUP (continued)

Party Line or Pay Phone

Cordless telephones will not work properly with a party line or pay phone, and are not approved for use with these systems by the telephone companies.

Ringer Equivalence Number: 0.1

DIALING SYSTEM

Set the **TONE/PULSE** switch to **TONE** if your telephone line has **touch tone** service.

If it has **rotary** service, set the switch to **PULSE**.

If you do not know which system is in use, ask your phone company.

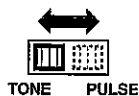

CHARGING THE HANDSET

1. Place the handset on the base station for **12 hours**. The **CHARGE** indicator lights.

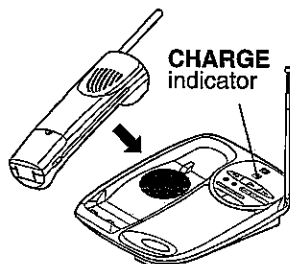

2. Remove the handset from the base station.

From then on, recharge the handset for a continuous 12 hours when the **BATT.LOW** indicator lights.

BATT.LOW -

Keep the charging contacts on the handset and base station clean. Dirty contacts may prevent the handset battery from charging.

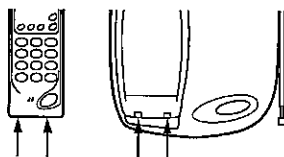

NOTE : No battery charging takes place while the telephone is powered by the backup batteries.

INITIAL SETUP (continued)

Standby time

When the handset battery is fully charged, your Sanyo cordless phone offers **up to 30 days of continuous standby time or up to 10 hours of continuous talk time**. (Listed standby time is measured under a situation in which handset is kept in standby mode only—no phone calls are made or received). Under normal usage conditions, recharging is required more often. Extensive use of the handset speakerphone reduces standby/talk time.

CAUTION : Repeated recharging for shorter periods may reduce battery capacity.

SECURITY CODE

This cordless telephone has a digital security system with 10,000,000 possible codes. This system helps prevent the unauthorized use of your telephone line by another cordless telephone.

IMPORTANT:

The following events may cause the security code to be erased and require resetting:

- After the handset battery is replaced or exhausted.
- After the backup batteries are exhausted during a power failure.

To reset your security code

1. Place the handset in the base station cradle, and make sure the **CHARGE** indicator lights.
2. Press **INTERCOM•PAGE/FIND** on the base station (within 8 seconds). The **IN USE** indicator flashes. A beep sounds, and the **IN USE** indicator goes out.

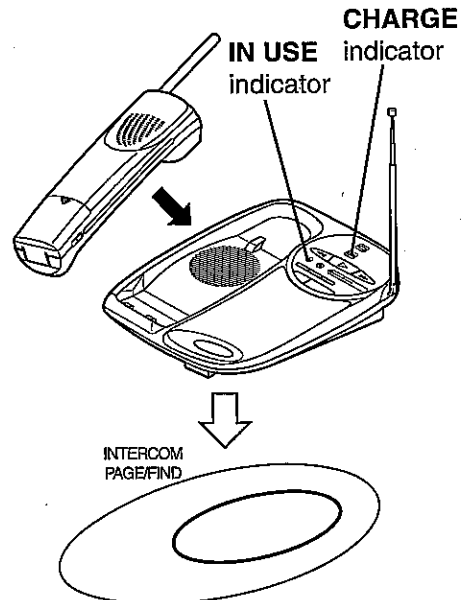

INITIAL SETUP (continued)

Notes:

- To change your security code at any time, simply repeat the steps above.
- If you experience difficulty in resetting the security code, first disconnect the AC adaptor from the unit, reconnect it, and then try again.
- The security code cannot be set while the unit is being powered by the AC power backup system.

REMEMBER:

If you do not install backup batteries in the base station, the security code will be lost when the power is interrupted. (if the AC adaptor is disconnected to move the unit to another room, for example.)

SPEAKER VOLUME CONTROL (Base station)

The **VOLUME** control on the side of the base station allows you to adjust the sound volume of the base station speakerphone as well as the built-in answering system.



NAMES OF CONTROLS

HANDSET

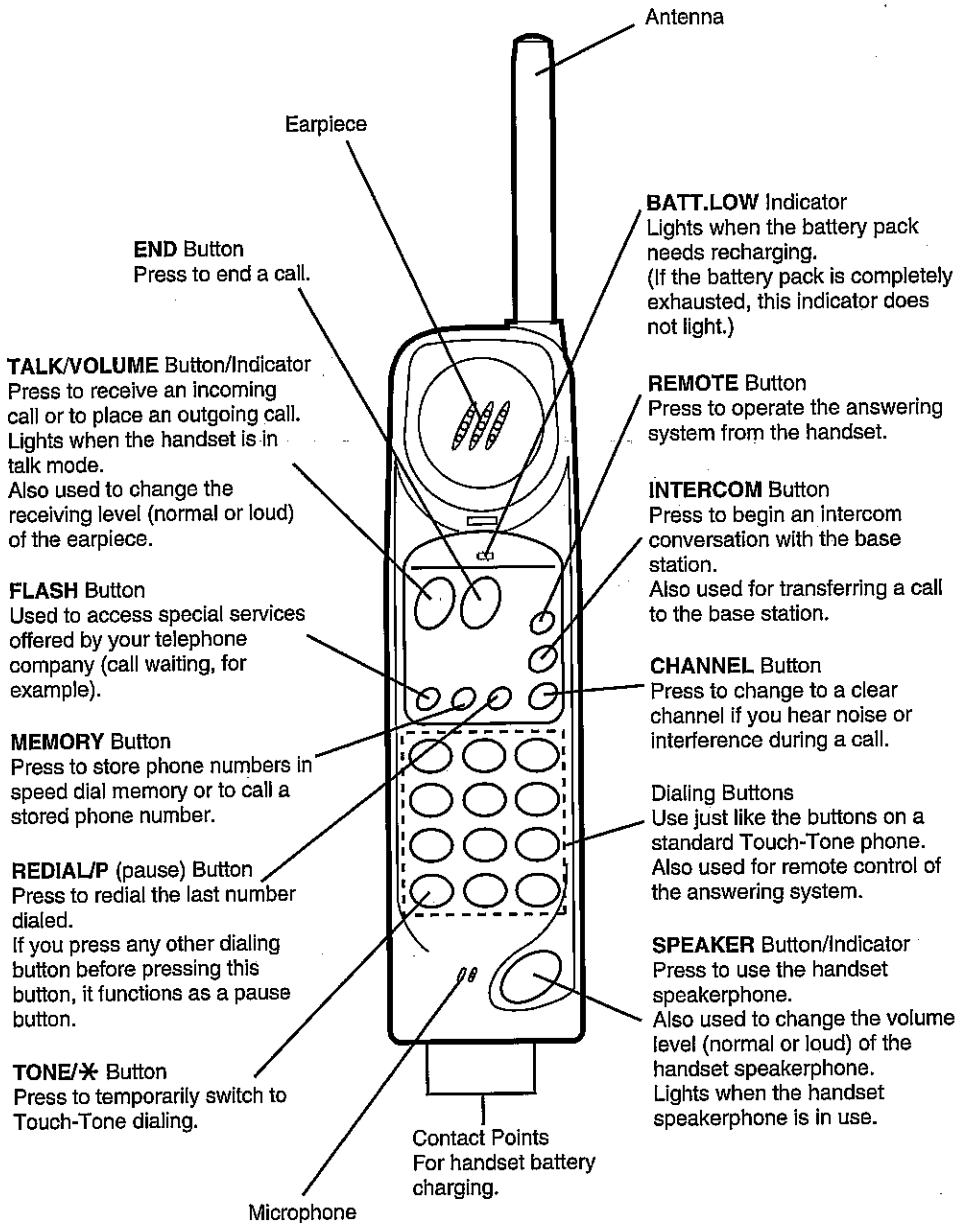

NAMES OF CONTROLS (continued)

HANDSET

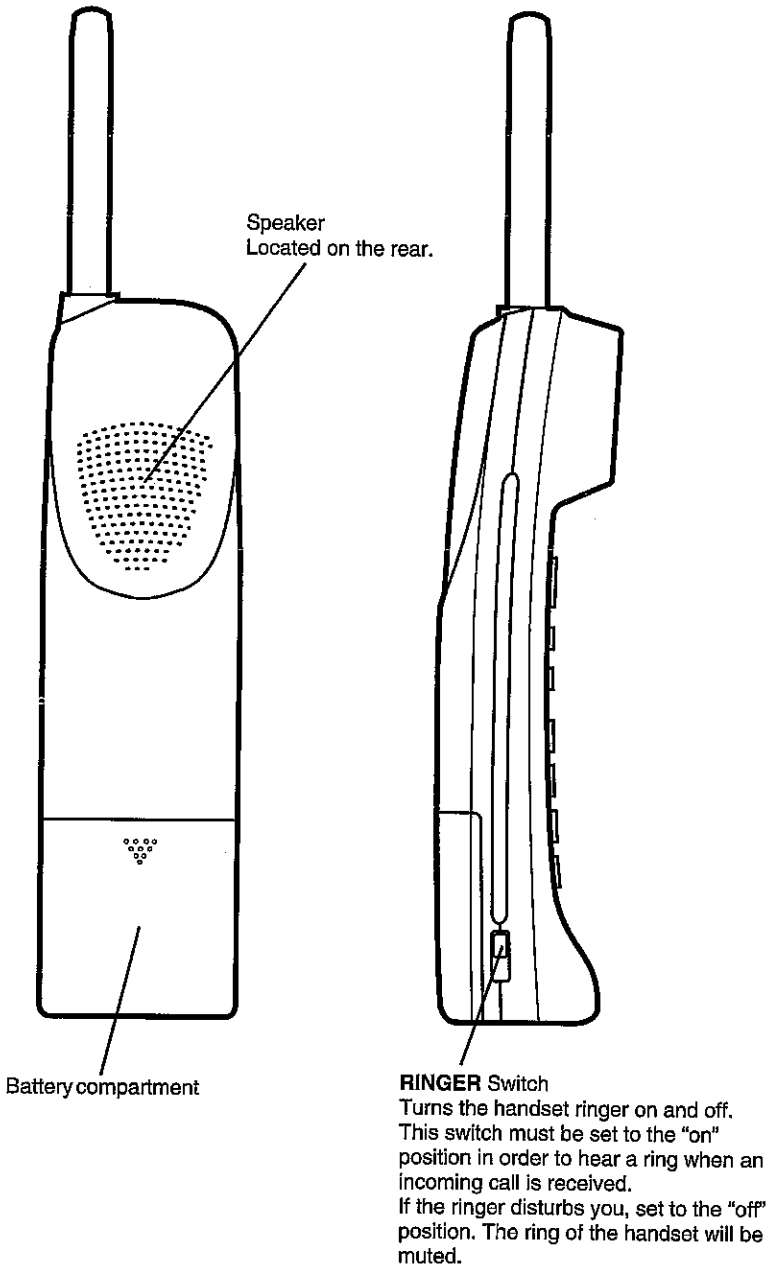

NAMES OF CONTROLS (continued)

BASE STATION

IN USE Indicator
Lights when the telephone, the intercom, or the answering system is in use.

POWER FAILURE BATTERY LOW Indicator
Lights when backup batteries are exhausted or not installed.

CHARGE Indicator
Lights when the handset battery is being recharged.

Backup battery compartment
Located on the underside.

Speaker

Antenna
For optimum performance, extend to full length.

Contact Points
For handset battery charging.

Microphone

INTERCOM•PAGE/FIND Button
Press to begin an intercom conversation with the handset user.
Also used to reset the security code.

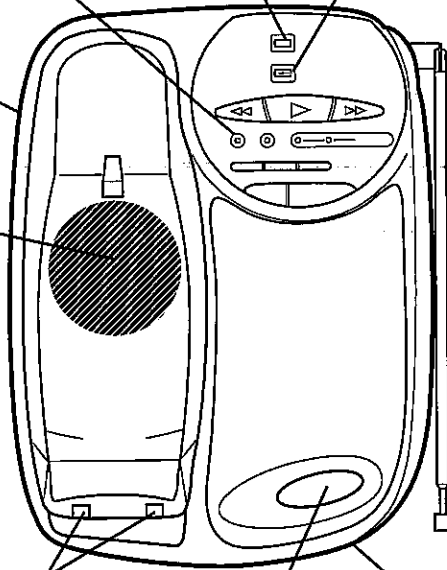

NAMES OF CONTROLS (continued)

BASE STATION

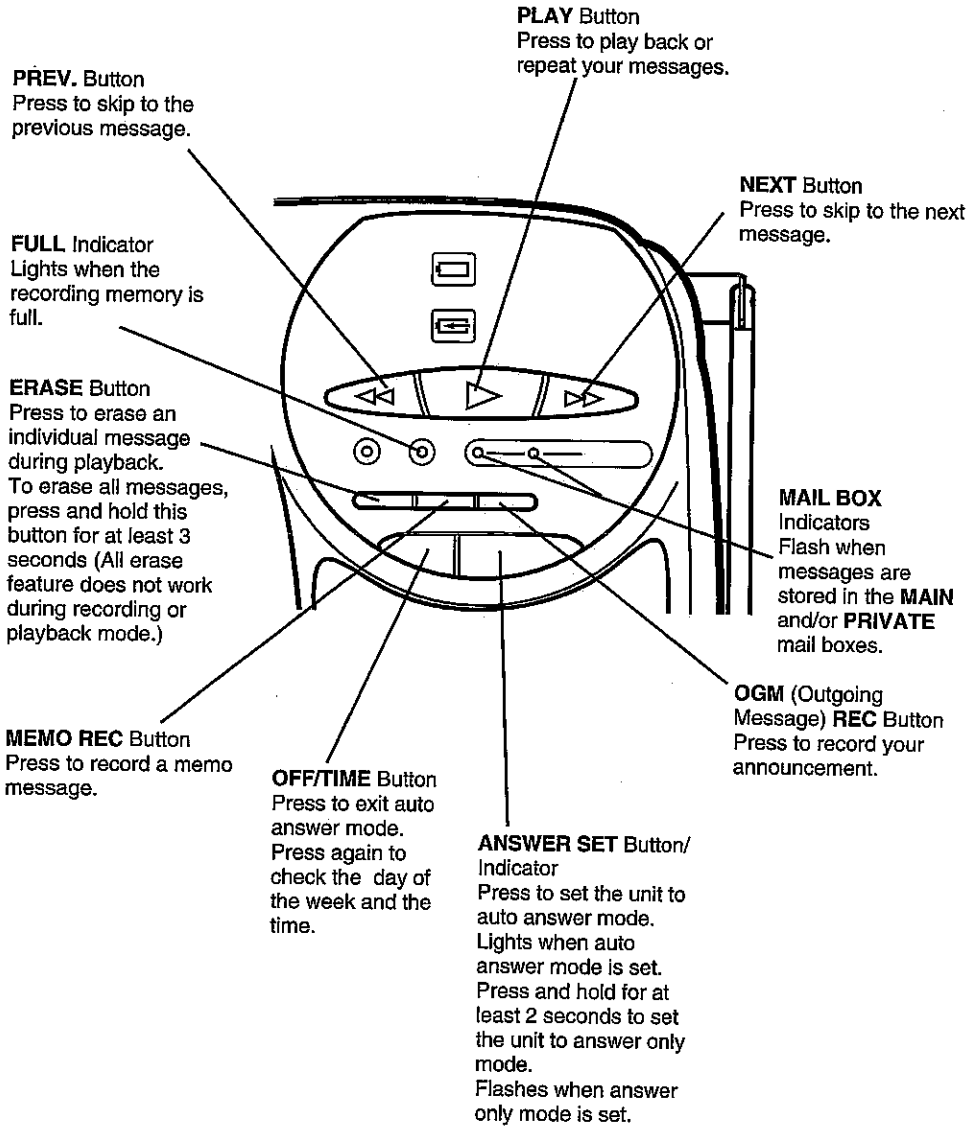

NAMES OF CONTROLS (continued)

BASE STATION

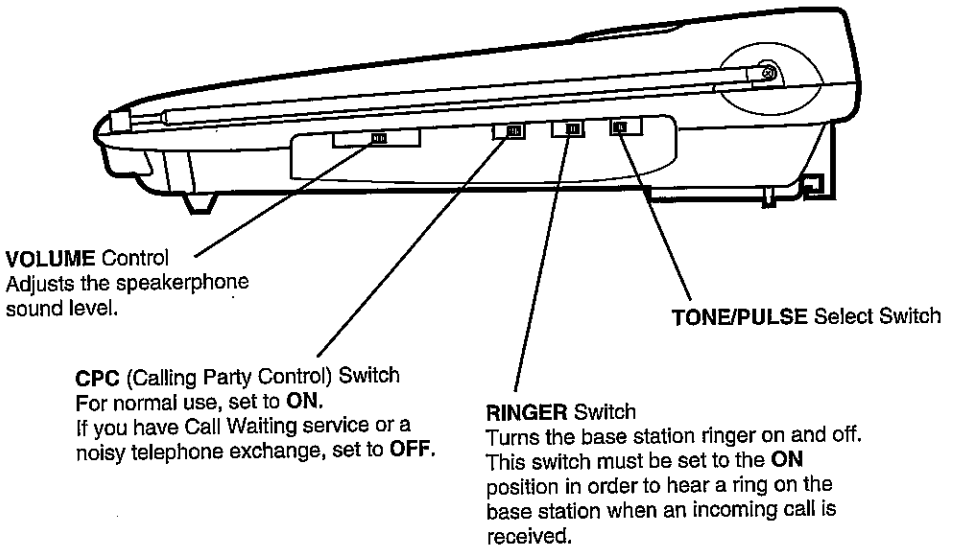
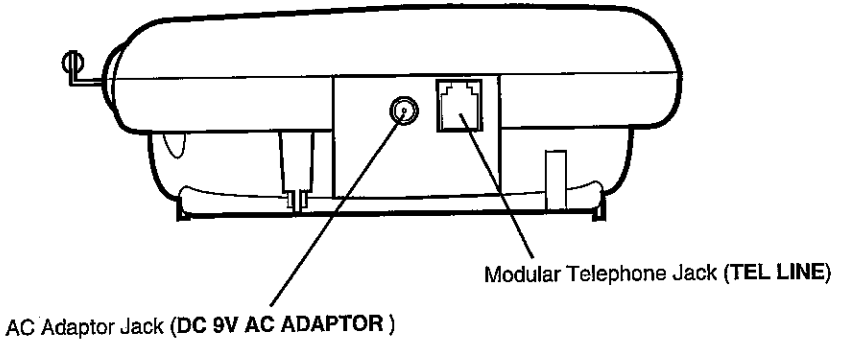

CORDLESS TELEPHONE OPERATION

BEFORE USING THE PHONE

CAUTION :

Small magnetised metal objects, such as pins or staples, may become attached to the earpiece of the handset. Avoid placing the handset near these objects.

1. Take the handset to the location you want to use it.
2. Press **TALK**. Verify that you get a dial tone and the **TALK** indicator lights. Your handset is ready to use.
3. Place a call or press **END** to hang up.

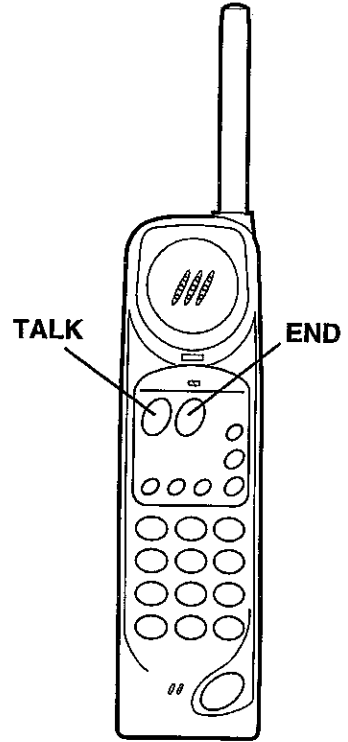

10-CHANNEL ACCESS/AUTO SCAN

Every time you answer or place a call using the handset, this cordless telephone automatically selects a clear channel from 10 channels available to transmit signals between the base station and handset. If you notice interference during a call, simply press **CHANNEL** button on the handset to access a clear channel.



CORDLESS TELEPHONE OPERATION (continued)

PLACING A CALL

1. Press **TALK**.
(Or lift the handset from the base station and then press **TALK**.)
The **TALK** indicator lights. The dialing buttons light for approximately 10 seconds.

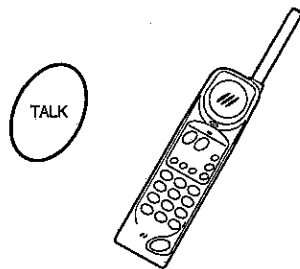

2. Dial the number.

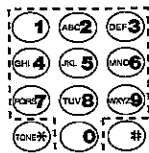

3. Press **END** to hang up.



To adjust the volume:

Press **TALK/VOLUME** once during a call. The volume level changes – normal or loud – each time **TALK** is pressed.

VOLUME



REMEMBER:

Your handset battery needs recharging when you hear a beep every 10 seconds during a phone conversation. (The **BATT.LOW** indicator also lights.)

CORDLESS TELEPHONE OPERATION (continued)

ANSWERING A CALL

1. When a call comes in, the dialing buttons and the **TALK** indicator flash.
The **IN USE** indicator on the base station also flashes.
2. Press **TALK**.
(Or lift the handset from the base station.)

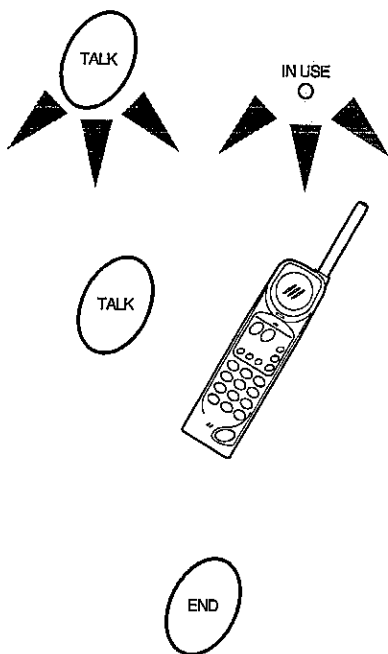

ANY KEY ANSWER

You can also press any key on the handset except **END** to answer the call.

When pressing **SPEAKER**, you can instantly talk with the handset speakerphone. (See page 19.)

3. Press **END** to hang up.

NOTES:

- If the handset **RINGER** switch is set to the **off** position, the handset will not ring.
- The cordless handset may ring slightly after the base station.
- If the handset is too far away from the base station, pressing **END** may not hang up a call. If this happens, come closer to the base station and then press **END**.

CORDLESS TELEPHONE OPERATION (continued)

USING THE HANDSET SPEAKERPHONE

The CLA-837X has the handset speakerphone which allows you to answer and place a call. It lets you have a handsfree phone conversation – no need to hold the handset.

To place a call using the handset speakerphone:

1. Press **SPEAKER** and listen for a dial tone. The **TALK** and **SPEAKER** indicators light. The dialing buttons light for approximately 10 seconds.



2. Dial the number.

Talk into the microphone.

The caller's voice is heard from the speaker on the back of the handset.

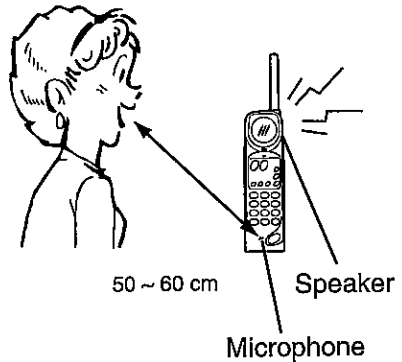
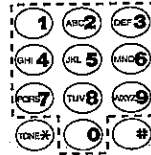

3. Press **END** to end the call.



REMEMBER:

Your handset battery needs recharging when you hear a beep every 10 seconds during a phone conversation. (The **BATT.LOW** indicator also lights.)

CORDLESS TELEPHONE OPERATION (continued)

To answer a call using the handset speakerphone:

1. Press **SPEAKER**.
The **SPEAKER** indicator lights.



2. Press **END** to end the call.



To adjust the speaker volume:

Press **SPEAKER** once during a call. The speakerphone sound level changes – normal or loud – each time the button is pressed.



CAUTION

When using the handsfree handset speakerphone, keep the speaker (located on the back of the handset) away from your ear to prevent any damage to your ear.

Switching between speakerphone and earpiece speaker

While you are using the phone through the handset earpiece speaker, press **SPEAKER** to start handsfree speakerphone conversation. Press **TALK** to use the earpiece for privacy.

CORDLESS TELEPHONE OPERATION (continued)

SPEED DIAL

The handset can store up to 10 phone numbers in its memory. You can dial a stored number simply by pressing **MEMORY** and the assigned 1-digit memory location number.

To store numbers in memory:

1. Press **MEMORY**.
The dialing button and **TALK** indicator light flash.

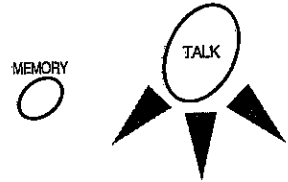

2. Dial the phone number you want to store, using the handset keypad.

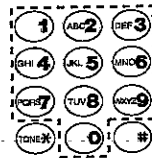

3. Press **MEMORY**.



4. Press a number button (0 - 9) to assign a memory location number to the phone number.

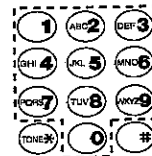

A beep sounds and the dialing button and **TALK** indicator light go off. The phone number is now stored in the handset memory.

5. Write the stored phone number on a speed dial directory labels (included).
6. Repeat steps 1 - 5 to store other numbers or to change previously stored numbers.

To insert a pause:

Stored phone numbers can include a 2-second pauses between two digits (after 9 to get an outside line in a PBX system, for example). Press **REDIAL/P** after the first digit.

A stored phone number can have up to 16 digits. (A pause counts as one digit.)

Note: To clear a stored phone number, press **MEMORY** twice, and then the assigned index number.

CORDLESS TELEPHONE OPERATION (continued)

To dial a number stored in the memory:

1. Press **TALK** or **SPEAKER** using the handset.
2. Press **MEMORY**.
3. Enter the location number (0 - 9) using the handset keypad.

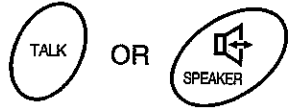

MEMORY

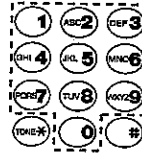

Speed dialing memory may be erased if the handset battery is replaced or exhausted.

REDIAL

You can automatically redial the last number called using **REDIAL/P** on the handset. A number of up to 32 digits can be redialed.

REDIAL/P



Note:

To redial after getting a busy signal, press **END**, then **TALK** or **SPEAKER**, then **REDIAL/P**.

CORDLESS TELEPHONE OPERATION (continued)

INSTANT TONE

If your home is equipped with pulse dialing and your phone is set to pulse mode, you can change to Touch-Tone dialing temporarily. This allows you to access special services available to Touch-Tone lines (electronic banking systems and remote-control answering machines, for example).

1. Dial the number you want to call.

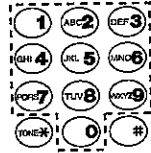

2. When your call is answered, press **[*]**.



The telephone stays in tone mode until the call ends. Then it returns automatically to pulse mode.

FLASH BUTTON

You can use **[FLASH]** to access special services, such as Call Waiting, offered by your phone company or PBX system.

If you subscribe to Call Waiting...

1. If a call comes in when you are already on the phone, a beep sounds.

2. Follow the instructions supplied by the phone company for the service for example:

Press **[FLASH]** "2"

You can talk to the second caller.



3. Press **[FLASH]** "2" again.

The second caller is placed on hold, and you can talk to the first caller.



NOTE: **[FLASH]** may also be used to get a new dial tone without pressing **[END]** or replacing the handset in the base station cradle. However, if your telephone line has special service features (like Call Waiting), **[FLASH]** may not operate in this way.

CORDLESS TELEPHONE OPERATION (continued)

INTERCOM

The intercom feature allows wireless communications between the base and handset users. The paging feature can also be used as a handset locator.

From Handset to Base Station (Auto Intercom)

1. Handset: Press **INTERCOM** to page the base station.
Base station automatically switches to intercom mode. The **IN USE** indicator lights.



2. Handset/Base station: Begin intercom conversation.
To use the handset speakerphone, press **SPEAKER** on the handset.



3. Handset: Press **END** to turn off the intercom.



Intercom while a call is on hold

During a telephone call, the handset user can talk to the base station user. (The outside call is automatically put on hold.)

1. Press **INTERCOM** to alert the base station. (The outside call is put on hold and the **TALK** indicator flashes.)
2. If you end the intercom conversation or the base station does not answer, press **TALK** to talk to the caller again.



CORDLESS TELEPHONE OPERATION (continued)

From Base Station to Handset

1. Base station: Press **INTERCOM•PAGE/FIND** to page the handset. The **IN USE** indicator flashes.

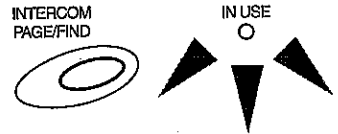

2. Handset: Press **TALK** (or any key except **END**) and begin intercom conversation.



(The handset user can also use the handset speakerphone.)

3. To turn off the intercom, press **END** on the handset.



Switching between speakerphone and earpiece receiver

During an intercom conversation, press **SPEAKER** to switch to handsfree speakerphone conversation. Press **INTERCOM** to return to earpiece receiver for privacy.

Room Monitoring

Using the intercom feature, the handset user can monitor the ambient sound of the room where the base station is located.

1. Press **INTERCOM** to begin monitoring.
(To improve the clarity of the monitor sound, cover the handset microphone with your hand.)



2. Press **END** to end monitoring.



Handset Locator

If you misplace the handset, press **INTERCOM•PAGE/FIND** on the base station to make the handset beep.



NOTE: If the handset **RINGER** switch is set to the **off** position, no beep will be produced.

DIGITAL ANSWERING SYSTEM OPERATION

TIME/DAY VOICE CLOCK

The voice tells you the day of the week and the time when you press **OFF/TIME**. You must set the voice clock in order to have time/day voice stamp on each message you receive and clock time announcement.

- This needs to be done only when you first set up the unit or when there is a time change.
- The AC power backup batteries maintain your clock setting during a power interruption as long as the backup batteries are functioning.

To set the voice clock

1. Press and hold **OFF/TIME** on the base station for at least 2 seconds.
The **ANSWER SET** indicator flashes rapidly.
A beep sounds.

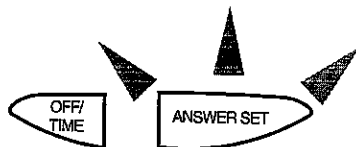

2. Press **PLAY**.
The voice announces a day of week.



3. Set the day of week by pressing **NEXT** or **PREV.** until you hear the correct day announcement.

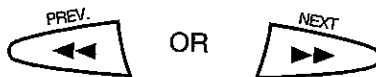

4. Press **PLAY**.
The voice announces an hour, and **AM** or **PM**.



5. Set the hour, and AM or PM by pressing **NEXT** or **PREV.** until you hear the correct hour announcement.

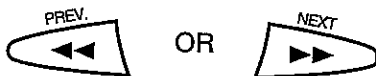

6. Press **PLAY**.
The voice announces a minute.



7. Set the minute by pressing (or continuously holding) **NEXT** or **PREV.** until you hear the correct minute announcement.
Continuously holding either button changes the minute 10 by 10.

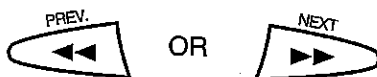

8. Press **ANSWER SET**.
The voice announces the time, and a beep sounds to confirm the clock setting is complete.

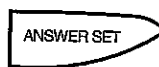

DIGITAL ANSWERING SYSTEM OPERATION (continued)

NOTES:

- While setting the clock, you must press each button within 90 seconds of the previous button press. If you take longer, the program mode self-cancels. To continue, restart from step 1.
- To cancel voice clock setting procedure at any time, press **OFF/TIME**.
- While the auto answer mode is set, the time/day announcement cannot be heard unless the auto answer mode is cancelled by pressing **OFF/TIME**.
- Setting the clock is required every 6 months.

To hear clock time announcement

1. Press **OFF/TIME**.
The **IN USE** indicator lights, and the voice tells you the current day of the week and the time.
2. During the voice clock announcement, press **OFF/TIME** again.
The voice tells you the remaining recording time.



NOTE:

The **Voice Clock** function is not available when the unit is set to the **Auto Answer** mode.

DIGITAL ANSWERING SYSTEM OPERATION (continued)

RING DELAY/TOLL SAVER

The Ring Delay feature lets you choose the number of times (1 - 9 times) the telephone rings before a call is answered. You can also set it to the **Toll Saver** mode, which allows you to save the cost of the call when calling your number to check your messages.

To set to the Toll Saver mode:

1. Press and hold **OFF/TIME** for approximately 2 seconds until a beep sounds.
The **ANSWER SET** indicator flashes rapidly.

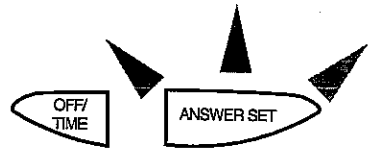

2. Press **OGM REC**.
The voice announces the previously set number of rings.



3. Press **NEXT** or **PREV.** until the voice announces "zero".

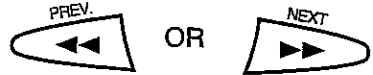

4. Press **ANSWER SET**.
The voice announces "zero", and a beep sounds.



When set to the **Toll Saver** mode, the telephone answers incoming calls on the **fourth ring** when there is no message recorded, and on the **second ring** when messages are left in your unit. When you call your number from another phone and hear three rings, you know you have no messages and can hang up to save the cost of the call.

To select a desired number of times your telephone rings before the unit answers callers:

1. Press and hold **OFF/TIME** for approximately 2 seconds until a beep sounds.
2. Press **OGM REC**.
The voice announces the previously set number.

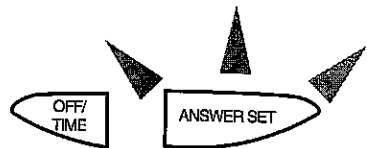

DIGITAL ANSWERING SYSTEM OPERATION (continued)

3. Press **NEXT** or **PREV.** until the voice announces the number of rings you want to set.

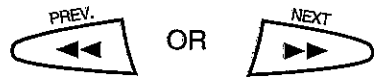

4. Press **ANSWER SET**.
The selected number is announced, and a beep sounds.
Your answering system answers all incoming calls on the selected number of rings.



CPC (Calling Party Control) SWITCH

The telephone systems in many areas provide a disconnect pulse when a caller hangs up. If the **CPC** switch (located on the side of the base station) is set to **ON**, the unit stops recording and returns to the auto answer mode when a disconnect pulse is received. This eliminates annoying recordings of dial tones between messages. The **CPC** switch should be kept in the **OFF** position if:

- Your telephone is equipped with Call Waiting service.
- You have a noisy telephone exchange.



CPC switch

If the **CPC** (calling party control) is set to **ON** in these cases, your calls may be disconnected prematurely.

DIGITAL ANSWERING SYSTEM OPERATION (continued)

RECORDING AN ANNOUNCEMENT

In addition to the built-in pre-recorded messages, you can record two different announcements of your own in the answering system.

Before you record your announcement, write down what you are going to say. An announcement can be up to 60 seconds each in length.

Sample Announcement 1

"Hello. This is (your name or phone number). Please leave your name and telephone number and a brief message, and your call will be returned as soon as possible. Thank you."

Sample Announcement 2 (to use with Private Mail box. See page 34.)

"Hello. This is (your name or phone number). To leave a message for Jenny, press the  (pound) key, and then the **1** key before speaking."

To record an announcement:

1. Press and hold **OGM REC** for at least 2 seconds.



A beep sounds, and the recording starts.

2. Record your announcement using the built-in microphone.

The **IN USE** indicator flashes during recording.

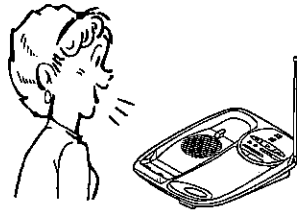

3. Press **OGM REC** again (or press **OFF/TIME**) to finish recording.



A beep sounds.

- Your announcement plays back automatically. (The **IN USE** indicator flashes rapidly.) A beep sounds.
- The total remaining recording time is announced by the voice.
- The unit is now ready to answer calls (**Auto Answer mode**).
- If available memory space becomes nil during recording, 3 beeps sound, and the voice announces "0 second remaining.". The **FULL** indicator lights.

DIGITAL ANSWERING SYSTEM OPERATION (continued)

To record a second announcement

1. Press **OGM REC** once, and within 2 seconds, press and hold it for at least 2 seconds. A beep sounds, and the recording starts.
2. Record your second announcement.
3. Press **OGM REC** again (or press **OFF/TIME**) to finish recording. A beep sounds.
 - Your announcement plays back automatically. (The **IN USE** indicator repeats two blinks.) A beep sounds.
 - The total remaining recording time is announced.
 - The unit is now ready to answer calls.

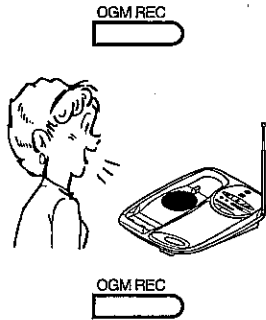

NOTES:

- If your announcement recording exceeds 60 seconds, the unit stops recording, plays back the recorded announcement and enters **Auto Answer** mode.
- The total recording time of the CLA-837X, including messages, announcements and memos, is approximately 20 minutes.
- To turn off **Auto Answer** mode, press **OFF/TIME**.
- Do not attempt to record an announcement when the **FULL** indicator lights. Erase some messages first.
- If total remaining recording time is less than 15 seconds when you finish recording, the unit will not enter **Auto Answer** mode. The **FULL** indicator lights, and the **ANSWER SET** indicator goes out.

Pre-recorded announcements:

The CLA-837X also has two built-in pre-recorded announcements. These are automatically substituted if no announcement is recorded by you.

Regular pre-recorded announcement

No one can answer the phone at the moment. Please leave a brief message. Thank you.

Pre-recorded announcement for Answer-Only mode (See page 32.)

No one can answer the phone at the moment. Thank you.

DIGITAL ANSWERING SYSTEM OPERATION (continued)

BEFORE YOU LEAVE

Setting Auto Answer Mode:

1. Press **ANSWER SET**.

The **IN USE** indicator flashes or lights.
The **ANSWER SET** indicator lights.
The selected announcement plays back followed by the total remaining recording time.

The unit is now ready to receive calls (**Auto Answer** mode).

Make sure there is enough recording time left to record caller's messages. If not, erase all or some of the messages.



Switching announcements:

1. Press **ANSWER SET** to play back the currently selected announcement.
 - The **IN USE** indicator lights while the built-in pre-recorded announcement is played back.
2. During playback, press **ANSWER SET**.
Announcement will switch.



NOTE:

- If the total remaining recording time is less than 90 seconds, the **FULL** indicator flashes. Erase all or some messages.
- If the total remaining recording time is less than 15 seconds, 3 beeps sound and the **FULL** indicator lights. The Auto Answer mode cannot be set.

Canceling (turning off) Auto Answer mode

1. Press **OFF/TIME**.

A beep sounds to indicate cancellation of auto answer mode.



DIGITAL ANSWERING SYSTEM OPERATION (continued)

Answer only mode

You can choose to set the CLA-837X to answer calls but not record any messages.

1. Press and hold **ANSWER SET** for at least 2 seconds.

The voice announces the selected announcement (The **ANSWER SET** indicator flashes.), and the unit sets to the **Answer Only** mode.

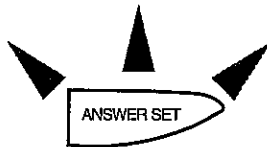

2. To switch announcement, press **ANSWER SET** repeatedly during announcement playback.

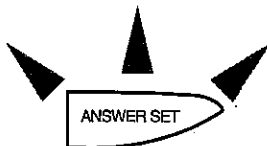

When set to **Answer Only** mode, the **ANSWER SET** indicator flashes. The pre-recorded announcement is automatically changes to the Answer Only version. (See page 30.) If you wish to use one of your own announcements, change the contents accordingly.

Canceling (turning off) Answer Only mode

1. Press **OFF/TIME**.
A beep sounds to indicate cancellation of answer only mode.



DIGITAL ANSWERING SYSTEM OPERATION (continued)

WHEN A CALL COMES IN

The unit answers all calls and records messages to a maximum of 90 seconds each. If you do not wish to record any messages, set to the **Answer Only** mode.

NOTES:

- A maximum of 59 messages (including memos and announcements) can be recorded.
- If available memory space runs out while a message is being recorded, the unit stops recording and the call is disconnected.
- If available recording time is reduced to less than 15 seconds after last message, the unit automatically switches into the **Answer Only** mode. After the announcement, 3 beeps sound, and the voice announces "0 second remaining".
- If the caller remains silent for more than 8 seconds during message recording, a beep sounds and the unit stops recording. Then the line disconnects.
- An extremely short message (less than 1 second) cannot be recorded.

Private Mail Box

This answering system comes with a **Private Mail Box** that allows callers to leave a personal message to a particular member of the household. Messages left in a **Private Mail Box** can be listened to only by using a programmable personal access code.

NOTE:

Messages recorded in the **Private Mail Box** share the total memory space of 20 minutes with other non-personal messages, which are recorded in the common section of the memory. If the total recording time runs out, neither the common section of the memory or the **Private Mail Box** can record.

To program a Mail Box access code:

1. Press and hold **OFF/TIME** on the base station for at least 2 seconds.
The **ANSWER SET** indicator flashes rapidly, and a beep sounds.
2. Press **MEMO REC**.
The **PRIVATE** indicator lights.
3. Press **NEXT** or **PREV.** repeatedly to select the desired code.
 - When initially pressing **NEXT**, "01" is announced regardless of the previously selected code.

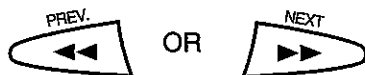
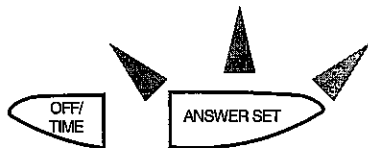

DIGITAL ANSWERING SYSTEM OPERATION (continued)

- When initially pressing **PREV.**, "99" is announced regardless of the previously selected code.
 - Continuously holding either button changes the code 10 by 10.
4. Press **ANSWER SET**.
The voice announces the selected code.
A beep sounds.

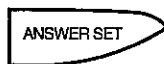

NOTES:

- While programming access codes, you must press each button within 90 seconds of the previous button press. If you take longer, the program mode self-cancels. To continue, restart from step 1.
- To cancel the procedure at any time, press **OFF/TIME**.
- To cancel a programmed code, follow steps 1 and 2, and press **ERASE**.
- If you forgot your access code, cancel the programmed code as described above, and reprogram a new one.
- No **Mail Box** access code has been programmed at factory.

To instruct callers to select a Private Mail Box:

To use the **Private Mail Box** feature, you must instruct your callers, in your announcement, to select the **Private Mail Box** before leaving a message. (See sample announcement 2 on page 29.)

1. A caller is answered by your announcement.
2. Following the instructions in your announcement, the caller presses the **#** key on a Touch-Tone dialing phone, and then press **1** to select the **Private Mail Box**.
3. The caller hears a beep, and can leave a message. The message will be recorded in the **Private Mail Box**.

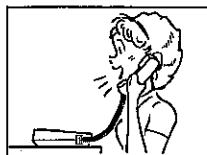
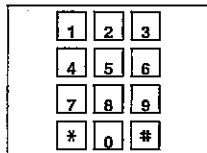

If a caller does not select the **Private Mail Box** at step 2, the message will be recorded in the common section of the memory.

DIGITAL ANSWERING SYSTEM OPERATION (continued)

WHEN YOU COME HOME

If there are messages recorded, the **MAIN** and/or **PRIVATE** indicator flash.



Message playback

Continuous playback

Press **PLAY**. All messages and memos recorded in the common section of the memory are played back once continuously, starting with the oldest one.



Time/day voice stamp

When you press **PLAY**, first the voice announces the total number of message received in the common section.

Then each message playback is preceded by the message number announcement, and then followed by a voice stamp indicating the day of the week and the time of the day when it was received.

NOTE: If the voice clock is not set, no time/day voice stamp is announced.

During playback, you can ...

Repeat

Press **PLAY**.
The message being played back repeats.



Skip to the next message

Press **NEXT**.
The next message plays immediately.



Skip to the previous message

Press **PREV.**.
The previous message plays immediately.



Erase the message you are listening to

Press **ERASE** for one second while the message you want to erase is playing.



Stop playback

Press **OFF/TIME**.
Playback stops.



DIGITAL ANSWERING SYSTEM OPERATION (continued)

All message erase

1. Press **OFF/TIME** to stop message playback.
2. Press and hold **ERASE** for at least 3 seconds.
3 beeps sound, and all messages are erased.
The voice announces "No messages."



This erases all incoming messages and memos recorded in the common section of the memory. A beep follows. Your announcements and the messages in the **Private Mail Box** are not erased by All Message Erase.

OTHER ANSWERING SYSTEM FEATURES

Call screening

You can monitor incoming calls to avoid unwanted calls.

1. Set the **VOLUME** control to the correct position to hear callers leave messages.
2. When a call comes in, but you do not want to speak to the caller, let the unit answer and record the message.
NOTE: Even if the unit is not set to the **Auto Answer** mode, you can press **ANSWER SET** after the telephone rings to screen the call.
3. To speak to the caller, pick up the handset.
4. When you finish speaking, hang up the telephone.
The unit returns to the auto answer mode.



You can screen calls from the handset. See page 42.

DIGITAL ANSWERING SYSTEM OPERATION (continued)

Extension phone disconnect

If you pick up an extension phone while a call is being answered by the CLA-837X, the unit automatically disconnects from the line to let you take the call.

If you pick up an extension phone after message recording has started, the call is counted as one call.

NOTE:

If you happen to pick up an extension phone immediately after the announcement has started to play, the unit may not disconnect. Wait for 2.5 seconds and pick up the phone.

Recording a memo

You can leave a memo (a recorded personal message) that can be retrieved manually or by remote control by anyone who has access to the answering system.

NOTE:

- The message count includes memos.
- A memo can be recorded for up to 90 seconds.

1. Press **MEMO REC**.

A beep sounds, and recording starts.



2. Record a memo using the microphone.

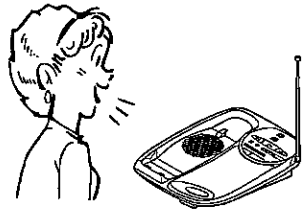

3. Press **MEMO REC** again (or press **OFF/TIME**) to finish recording.

A beep sounds.



DIGITAL ANSWERING SYSTEM OPERATION (continued)

NOTE:

- If the 90-second memo record time runs out while recording, the unit stops recording automatically.
- If the remaining recording time runs out while recording, 3 beeps sound, the unit stops recording and the voice announces "0 second remaining."
- If the remaining total recording time is reduced to 15 seconds during recording, the unit stops recording and switches to **Answer Only** mode.

You can also leave personal memo/messages in a **Private Mail Box**. The messages recorded in **Mail Box** are protected by your **Mail Box** access code. See page 33.

REMOTE OPERATION (From the handset)

The cordless handset of your CLA-837X is like a portable answering system that allows you to operate almost every answering system function from the handset, without going to the base station.

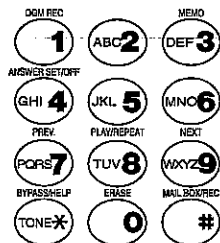

Setting to auto answer mode:

1. Press **REMOTE**.
The **TALK** indicator flashes, and the voice announces the number of messages recorded in the common section of the memory.
2. Press **4** **ANSWER SET/OFF** to play back the current announcement. To switch to another announcement, press **4** again while listening to the current one.
After the remaining recording time announcement, the unit sets to **Auto Answer** mode.

REMOTE



ANSWER SET/OFF



Canceling (turning off) Auto Answer mode:

1. Press **REMOTE**.
2. Press **4**.
A beep sounds to indicate cancellation of the **Auto Answer** mode.

REMOTE



ANSWER SET/OFF



DIGITAL ANSWERING SYSTEM OPERATION (continued)

Message playback - continuous mode

1. Press **REMOTE**.
2. Press **8** **PLAY/REPEAT**.

REMOTE



PLAY/REPEAT



During playback, you can ...

Repeat

Press **8**.

The message being played back repeats.

PLAY/REPEAT



Skip to the next message

Press **9**.

The next message plays immediately.

NEXT



Skip to the previous message

Press **7**.

The previous message plays immediately.

PREV.



Single message erase

During play back, press **0** twice within 2 seconds.

The currently playing message is erased. 3 beeps sound to confirm the erasure.

ERASE



Playback bypass

Press **X**.

All remaining messages are bypassed. You can now access other answering system functions.

BYPASS/HELP



DIGITAL ANSWERING SYSTEM OPERATION (continued)

When all messages have been played back (or you have bypassed all messages by pressing **[*]**), you can continue to access other features:

Recording/changing your announcement

1. Press **[1]** twice within 2 seconds.
2. State your announcement after a beep.
3. Press **[1]** to stop recording.
The new announcement plays back after a beep. The remaining recording time is announced.



- You can record only one announcement (1) by remote.

Canceling Auto Answer mode

1. Press **[4]**.



Listening to help prompts

1. Press **[*]** once for each prompt.



Erasing all messages

1. Press **[0]** three times within 3 seconds.
This erases all incoming messages and memos recorded in the common section of the memory. A beep follows.
Your announcements and the messages in the **Private Mail Box** are not erased by All Erase.



DIGITAL ANSWERING SYSTEM OPERATION (continued)

Hearing messages recorded in a Private Mail Box

1. Press **#**.
2. Press **1** to select the **Private Mail Box**.
3. Enter your Mail Box access code.
A beep confirms the correct code entry.

MAIL BOX/REC



OGM REC

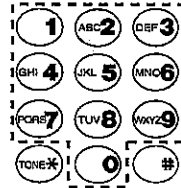

4. Press **8**.
Playback starts.

PLAY/REPEAT



- To erase a message in a **Private Mail Box**, press **0** twice while it is playing.
- To erase all messages in a **Private Mail Box**, press **0** 3 times within 3 seconds after having played all messages in the Mail box.

Recording a memo into your Mail Box

1. Press **#**.
2. Press **1** to select the **Private Mail Box**.
3. Press **#**.
4. Record your message after a beep.
5. Press **#**.
A beep sounds. Recording stops and the recorded message plays back.

MAIL BOX/REC



OGM REC



MAIL BOX/REC



MAIL BOX/REC



DIGITAL ANSWERING SYSTEM OPERATION (continued)

Call screening (Using the handset)

The CLA-837X lets you monitor incoming calls to avoid unwanted calls even when you are using the handset away from the base station. (The **TALK** indicator flashes to show that an incoming message is being recorded.)

1. Make sure the base station is set to the **Auto Answer** mode.
2. When a call comes in, press **REMOTE** after ringing stops. You can hear the caller leaving a message. The **TALK** indicator flashes.
3. If you want to speak to the caller, press **TALK**.
4. Press **END**.

REMOTE



Recording a memo

1. Press **REMOTE**.
2. Press **3**.
The **TALK** indicator flashes.
3. Record a memo after a beep.
4. When you finish, press **END**.
5. Press **8** to play back the recording.

REMOTE



PLAY/REPEAT



DIGITAL ANSWERING SYSTEM OPERATION (continued)

REMOTE OPERATION (From a Touch-Tone Telephone)

You can access your answering system to retrieve messages from outside your home. Your remote access code (which you select from 100 possible combinations) helps ensure your privacy.

You must use a Touch-Tone phone*, and press each button firmly.

* There may be some Touch-Tone phones that do not allow remote operation.

NOTE:

- The unit must be set to **Auto Answer** mode to be accessed by a remote telephone. (Except for the remote turn-on feature, which lets you set the unit to auto answer mode by remote.)
- The remote feature does not work when you call the unit from a pulse-dialing telephone.
- While beeps sound, the answering system will not respond to any push-button entry.

Programming your remote access code:

1. Press and hold **OFF/TIME** on the base station for at least 2 seconds.
The **ANSWER SET** indicator flashes rapidly, and a beep sounds.
2. Press **ANSWER SET**.
The voice announces the code previously set.
3. Press **NEXT** or **PREV.** repeatedly until the voice announces the desired code (00~99).
Continuously holding either button changes the code 10 by 10.
4. Press **ANSWER SET**.
The voice confirm your new code.
A beep sounds.

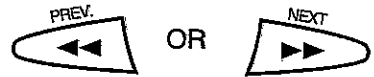
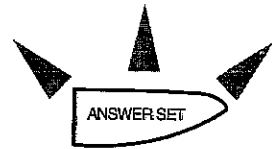
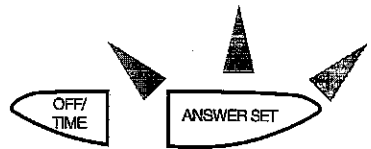

* If you select **00** as your remote access code, the **Remote Turn-On** feature cannot turn the unit on.

DIGITAL ANSWERING SYSTEM OPERATION (continued)

NOTE:

- You must press each button within 90 seconds of the previous button press. If you take longer, the program mode self-cancels. To continue, restart from step 1.
- To cancel entering procedure, press **OFF/TIME**.
- The remote access code has been factory-set to **99**.

Message playback

1. Dial your phone number and listen to your announcement.
2. Enter your remote access code immediately after the beep at the end of the announcement.

Example: Access code number "07"

Press **0**, and **7** within 2 seconds.

All recorded messages (with message number and time/day voice stamp) are played back from the oldest one.

NOTE:

To bypass your announcement, press ***** while it plays back. Then enter your remote access code after you hear a beep.

3. You can hang up now. All messages are kept in memory.

CAUTION:

If you want to hang up the telephone before all messages have played back, you must press ***** to bypass all messages. If not, the unit continues message playback, and your phone line will be busy until the last message is played back.

DIGITAL ANSWERING SYSTEM OPERATION (continued)

During playback, you can ...

Repeat

Press **[8]**.

The message repeats.

Skip to the next message

Press **[9]**.

The next message plays immediately.

Skip to the previous message

Press **[7]**.

The previous message plays immediately.

Single message erase

Press **[0]** twice within 2 seconds.

The currently playing message is erased. 3 beeps sound to confirm the erasure.

Playback bypass

Press **[*]**.

All remaining messages are bypassed. You can now access other answering system functions.

Within 10 seconds of the end of playback or playback bypass, you can continue to access other remote features:

Listening to all messages again

1. Press **[8]** to repeat playback of all messages recorded in the common section.

Listening to your announcement

1. Press **[4]**.

Switching announcement

1. Press **[4]**.

Your current announcement plays.

2. Press **[4]** again during the playback to select another announcement.

DIGITAL ANSWERING SYSTEM OPERATION (continued)

Changing your announcement

1. Press **1** twice within 2 seconds.
 2. State your new announcement after a beep.
 3. Press **1** to stop recording.
The new announcement plays back after a beep. The remaining recording time is announced.
- You can record only one announcement (1) by remote.

Recording a memo

1. Press **3**.
2. Record a message.
3. Press **3** to finish recording.
You will hear the message number and the playback of the memo you just recorded.

If the recording exceeds the 90-second time limit, or if the remaining recording times runs out, the unit stops recording.

If you hang up without pressing **3** at step 3 to finish recording, the unit remains in the recording mode (and will not answer calls) for up to 90 seconds.

Canceling Auto Answer mode

1. Press **4**.
A beep sounds.

Room-monitoring

You can monitor the ambient sound of the room where the base station is located.

1. Press **6** to begin monitoring.
After 30 seconds, a beep sounds and monitoring stops.
To restart, press **6** again.

DIGITAL ANSWERING SYSTEM OPERATION (continued)

Erasing all messages

1. Press **[0]** three times within 3 seconds.

This erases all incoming messages and memos recorded in the common section of the memory. A beep follows. Your announcements and the messages in the **Private Mail Box** are not erased by All Erase.

Listening to help prompts

1. Press **[*]** once for each prompt.

Listening to messages in a Private Mail box

1. Press **[#]**.
2. Press **[1]** to select the **Private Mail box**.
3. Enter your Mail Box access code.

Messages are played back from the oldest one.

During playback, you can ...

Stop the playback: Press **[*]**

Skip to the next message: Press **[9]**

Skip to the previous message: Press **[7]**

Repeat the message: Press **[8]**

Erase the message: Press **[0] + [0]**

Recording a memo into your Mail Box

1. Press **[#]**.
2. Press **[1]** to select the **Private Mail box**.
3. Press **[#]**.
4. Record your message after a beep.
5. Press **[#]** again to finish recording.

A beep sounds. Recording stops and the recorded message plays back.

Turning on answering system

If you have left home without setting the unit to **Auto Answer** mode, you can turn it on from a Touch-Tone telephone.

1. Dial your phone number.
2. Let the phone ring 16 times. A beep sounds.
3. Enter your access code within 10 seconds.
Example: Press "0" and "7".
4. You will hear a beep, then your announcement.
5. Press **[4]** to set the unit to **Auto Answer** mode.

If you have programmed **00** as your remote access code, the unit will not respond even after the telephone rings 16 times.

MAINTENANCE

AC POWER BACKUP SYSTEM

This cordless telephone has a battery backup system to allow operation during a power interruption up to 24 hours of standby time or up to 6 hours of continuous handset talk time (handset with fully charged Ni-Cd battery).

This backup system also assures uninterrupted answering system operation. However, key response becomes slower during power failures.

For optimum performance during a power failure, the backup batteries must be fresh and the handset battery must be fully charged at the beginning of the power outage. The backup system requires 4 AA alkaline batteries (not supplied).

CAUTION: A power failure may occur at any time without you being aware of it (while you are sleeping, away from home, etc.). During a power failure, the base station receives power from the backup batteries. If a power failure occurs for an extended period, or for several brief periods, the useful life of the backup batteries will be shortened.

To install backup batteries:

1. Make certain that the AC adaptor is connected to the base station.
2. Open the backup battery compartment lid by pushing the notches.
3. Install 4 AA batteries (not supplied) as indicated in the battery compartment.
4. Close the lid.

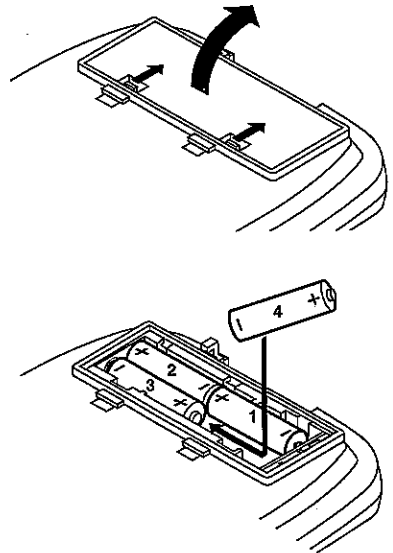

NOTES:

- If backup batteries are not installed, the telephone stops functioning immediately when the power is interrupted (for example, if the AC adaptor is unplugged to move the base station).
- The **POWER FAILURE BATTERY LOW** indicator lights when the backup batteries are exhausted or not installed with the AC adaptor connected.
- The backup system is inactive when AC power is supplied to the base station.

MAINTENANCE (continued)

When installing the batteries:

To prevent corrosive leakage from batteries, which can cause personal injury and damage to the unit, observe the following precautions:

- Match the polarities (+ and - signs) on batteries to the polarities shown inside the battery case.
- Do not mix new batteries with old or used batteries.
- Only use batteries of the same type and brand.
- If the unit is not to be used for an extended period of time, remove the batteries and store them in a cool place.
- Carefully follow the battery manufacturer's instructions for proper use and disposal.
- DO NOT ALLOW YOUNG CHILDREN TO HANDLE BATTERIES.

NOTE:

SPENT OR DISCHARGED BATTERIES MUST BE RECYCLED OR DISPOSED OF PROPERLY IN COMPLIANCE WITH ALL APPLICABLE LAWS.

WALL MOUNTING

To mount the base station on a wall

1. Insert the hooks of the wall-mount bracket in the holes ① on the underside of the base station. Then push them in the direction of arrow ② as shown.
2. Connect a short modular telephone cord (not supplied) to the wall plate.
3. Mount the base station on the wall phone plate and seat it securely.

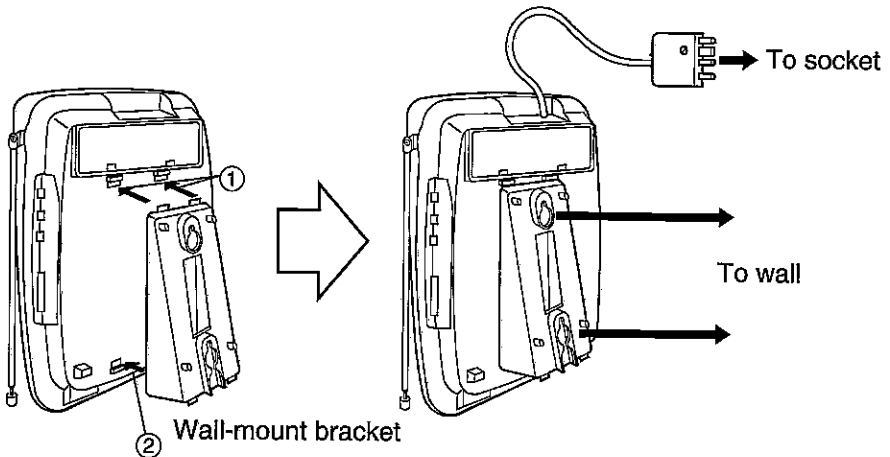

MAINTENANCE (continued)

RECHARGEABLE HANDSET BATTERY

Recharge handset in the base station cradle for a continuous 12 hours when the **BATT.LOW** indicator lights. (See page 7).

Repeated recharging for shorter periods may reduce battery capacity.

Battery Refresh

If your battery seems to need recharging more often than usual, it may have lost part of its charging capacity because of premature recharging. To return the battery to its full capacity, try the battery refresh procedure.

- Discharge the battery by leaving the handset in talk mode until the **BATT.LOW** indicator lights. (First, disconnect base station from phone line.)
- Charge the handset for 12 hours.
- Repeat this procedure once more.

If performance still doesn't improve, it's time to replace the battery.

REMEMBER: Reset security code after a battery refresh (page 8-9).

REMEMBER:

Your handset battery needs recharging when you hear a beep every 10 seconds during a phone conversation. (The **BATT.LOW** indicator also lights.)

Cleaning the contact points

To ensure that the handset battery charges properly, clean the contact points on the handset and the base station once a month with a soft cloth.

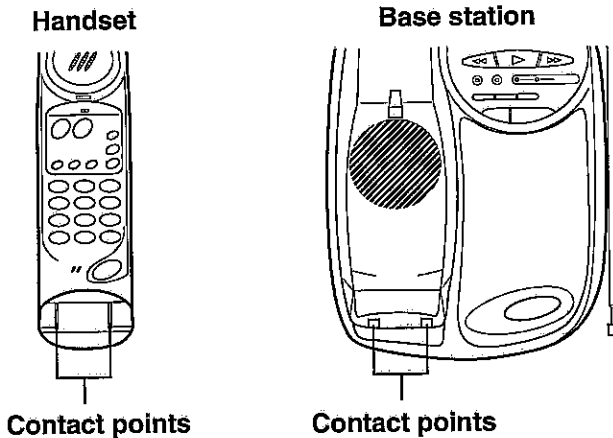

MALFUNCTIONS

Although it is unlikely that the base station will malfunction, if it does, disconnect it from the telephone line until proper repairs are completed.

The cordless telephone uses radio frequencies for transmission and reception, and is subject to certain operating conditions. The following conditions are normal and could affect the operation of your system.

1. NOISE

Electrical pulse noise is present in most homes at one time or another. This is most intense during electrical storms. Certain kinds of electrical equipment such as light dimmers, fluorescent bulbs, motors, fans, etc., also generate these noise pulses. Because radio frequency transmissions are susceptible to these pulses, on occasion you may hear them in your handset. Generally they are a minor annoyance and should not be interpreted as a defect in your system.

2. RANGE

Because radio frequencies are used, the location of the base station can affect the operation range. Try several locations in your home or business and pick the one that gives you the clearest signal to the handset. Turning around while holding the handset may help you find the best position.

3. INTERFERENCE

Electronic circuits activate a relay to connect the cordless telephone to your telephone line. These electronic circuits operate in the radio frequency spectrum. While several protection circuits are used to prevent unwanted signals, there may be periods when these unwanted signals enter the base station. You may hear clicks or hear the relay activate while you are not using the cordless handset. If this starts occurring frequently, it can be minimized or eliminated by lowering the height of your base station antenna, or relocating the base station. Check for interference before selecting your final base station location by plugging it in and monitoring it for clicks.

Two cordless systems should not be operated too close to each other because of interference. This interference can be reduced by lowering your base station antenna, thereby reducing its range.

TROUBLESHOOTING

If you have a problem with your cordless telephone/answering system, try the following suggestions before calling for service.

CORDLESS TELEPHONE SECTION

The phone does not work at all:

- The AC adaptor may not be plugged into a wall outlet.
- The battery pack may need recharging. (**BATT.LOW** indicator lights in talk mode.)
- The security code may not be set properly. (See page 8.)
- The handset may be too far from the base station.

Incoming calls do not ring on the handset:

- The handset may be too far from the base station.
- The **RINGER** switch may be set to the **OFF** position.

ANSWERING SYSTEM SECTION

Your announcement does not play back:

- The announcement may not have been recorded properly. Press **OGM REC** firmly before recording.

I know I had calls, but no messages have been recorded:

- The unit may be set to **Answer Only** mode. (If set to **Answer Only**, the **Answer Set** indicator flashes.)
- No recording time is left. Erase all or unwanted messages.

The unit disconnects before the caller has finished leaving a message:

- The caller may have kept silent for 8 seconds or more.
- The caller's voice may have been extremely low.
- The caller may have spoken for more than 90 seconds.

The telephone rings but the unit does not answer the phone:

- This may be because more than three telephones are connected to one line.

You hear beeps but no messages during message playback:

- A caller probably hung up without leaving a message. The beeps you hear represent each time your announcement was played, not each time someone spoke.

TROUBLESHOOTING (continued)

You try to retrieve your messages from an outside phone, but nothing happens:

- You may not have entered the correct remote access code.
- You may not be using a Touch-Tone telephone.
- You may have entered your remote access code before the beep that follows your announcement.

The unit does not function after you experience a static shock from it:

- Disconnect the AC adaptor and remove all batteries. Then reconnect the AC adaptor and reinstall the batteries. The unit resets itself automatically.

You cannot record announcement but you hear 3 beeps:

- Total remaining recording time is less than 15 seconds (or, 59 messages have been recorded). The **FULL** indicator lights. Erase all or unwanted messages.

You cannot record a memo:

- Press **OFF/TIME** twice to check the total remaining recording time. The **FULL** indicator lights. Erase all or unwanted messages.



1AD6P1P0605-K
(AU)

SANYO

SANYO Electric Co., Ltd.
Printed in Malaysia