

SANYO

INSTRUCTION MANUAL

CP32WF2

Colour Television

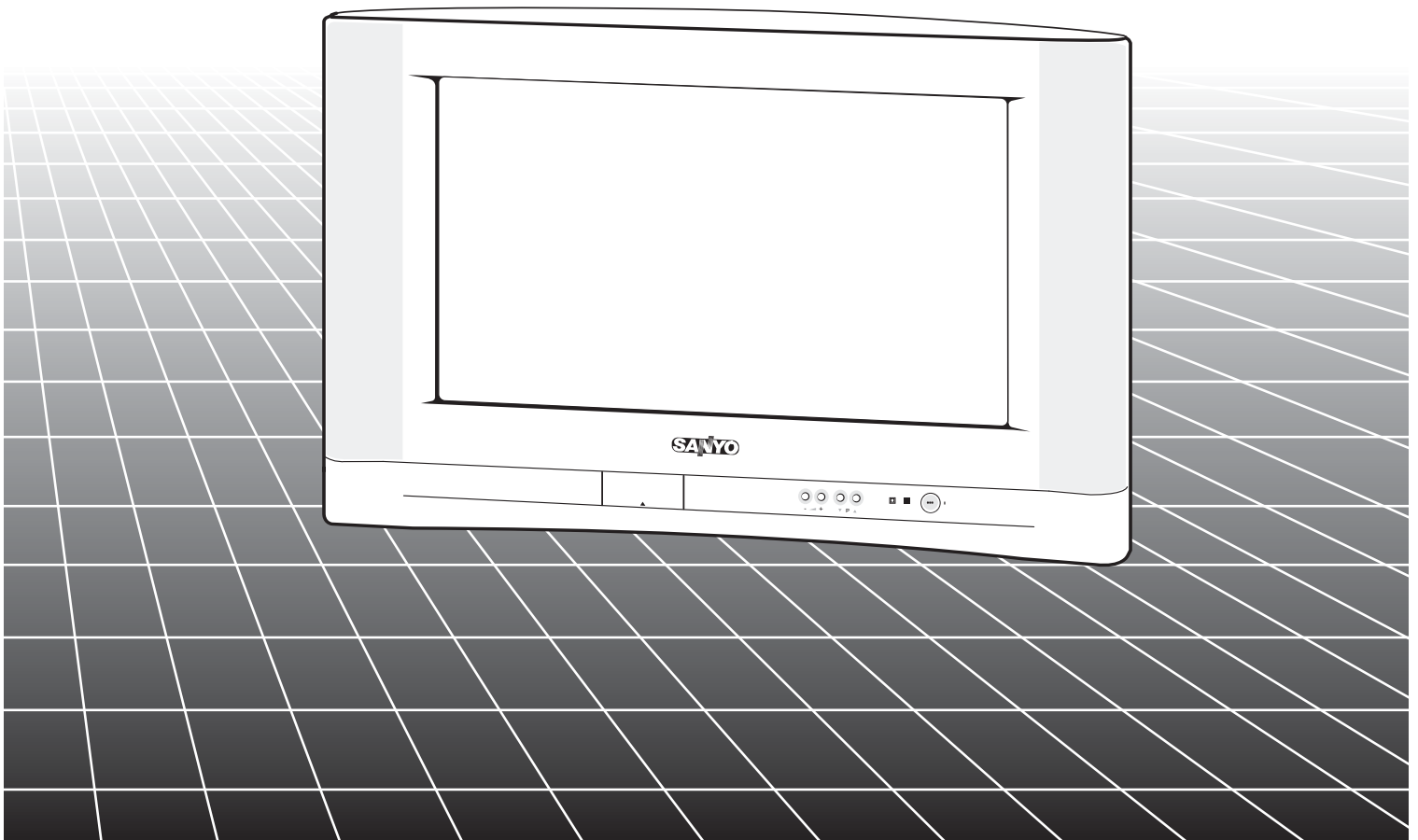

- **77cm Flat Wide Screen**
- **A2 & Digital NICAM Stereo**
- **Surround & Bass Expander Sound System**
- **SCART Terminal for STB & Audio/Video Input**

SAFETY PRECAUTIONS

CAUTION: Please read and retain for your safety.

This television receiver has been engineered and manufactured to assure your personal safety. But improper use can result in potential electrical shock or fire hazards. In order not to defeat the safeguards incorporated in this receiver observed the following basic rules for its installation, use and servicing.

■ Installation

Do not allow anything to rest on the power cord.

Do not locate this television receiver where the cord will be damaged by people walking on it.

Do not overload wall outlets and extension cords as this can result in fire or electric shock.

Slots and openings in the cabinet and in the back or bottom are provided for ventilation to ensure reliable operation and to protect it from overheating. These openings must not be blocked or covered.

The opening should **never** be covered with a cloth or other material, and the bottom openings should not be blocked by placing the television receiver on a bed, sofa, rug, or other similar surface.

This television receiver should **never** be placed near or over a radiator or heater. This television receiver should not be placed in a built-in installation such as a bookcase unless proper ventilation is provided.

Do not place your television receiver on an unstable stand, shelf or table.

Serious injury to an individual and damage to the television may result if it should fall. Your sales person can recommend approved stands or shelf and wall mounting instructions.

If the television is to be built into a compartment or similarly enclosed, the minimum distances **must** be maintained.

Heat build-up can reduce the service life of your television, and can also be dangerous.

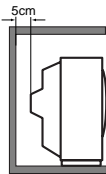
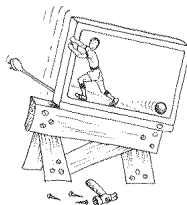
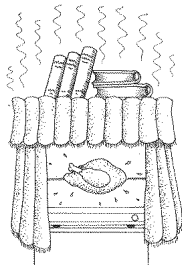
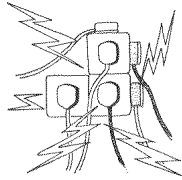

Minimum distances

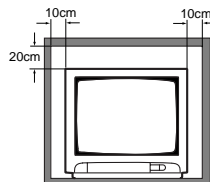

■ Use

This television receiver should be operated only from the type of power source indicated on the television or as indicated in the Operating Instructions. If you are not sure of the type of power supply in your home, consult your sales person or your local power company.

Never add accessories that have not been specifically designed for this television.

Do not drop or push objects into the television cabinet slots or openings. Some internal parts carry hazardous voltages and contact may result in an electrical shock hazard. **Never** spill liquids of any kind on the television receiver.

Do not expose the television receiver to rain or use it near water.

For example, near a bathtub, kitchen sink, in a wet basement, etc. Before cleaning, unplug the television receiver from the wall socket.

Never stand on, lean on or push suddenly the television or its stand. You should pay special attention to children. Serious injury may result if it should fall.

Do not apply liquid cleaners or aerosol cleaners directly onto the television receiver. Use the damp cloth for cleaning.

Do not squash power supply cord under the television receiver.

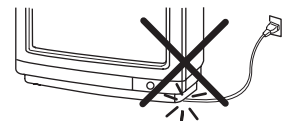
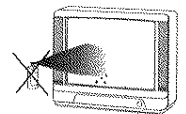
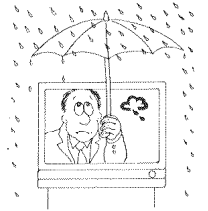
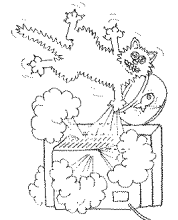
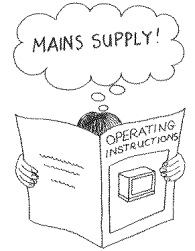

INSTALLATION

Step 1

Batteries installation

- 1 Remove the battery cover by pulling it in direction of the arrow.
- 2 Install two "AA" 1.5 volt batteries so that the "+" and "-" marks on the batteries match the "+" and "-" marks inside the unit.
- 3 Close the battery cover.

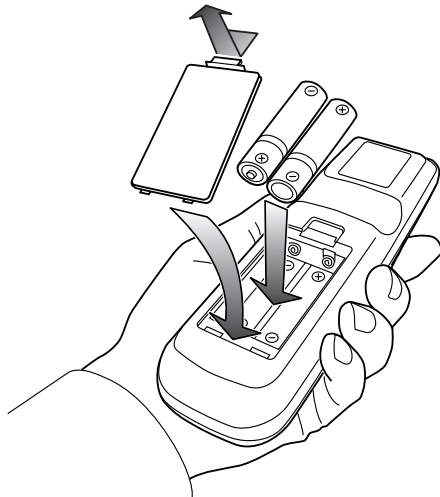

- Replace the batteries when the TV set is showing the following symptoms: Operation is unsteady or erratic, sometimes the TV does not work with the transmitter. Discharged batteries may leak and damage the unit. The normal life of batteries should be from nine to ten months.

Step 2

Connecting the aerial

Use one of these methods to connect a signal to your TV.
Following connection examples are our recommended standard connection. For further information please consult your local dealer.

Outdoor Antenna with VCR and TV

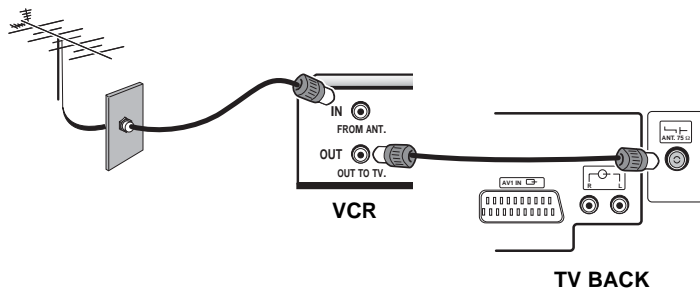

Cable with Set Top Box and TV

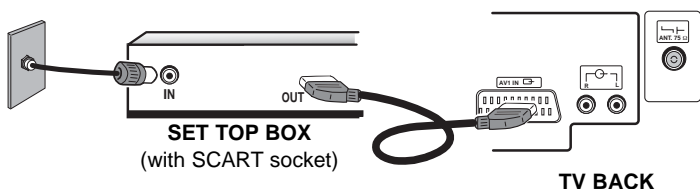

Outdoor Antenna or Cable and TV



- For all aerial circuit problems please consult your local dealer.
- The connection to peripheral AV equipment, refer to section "USE OF AV EQUIPMENT".

Step 3

STEP3: Connecting AC cord

- Connect the power cord of the TV set to a wall outlet.
- The TV set is prepared for a mains voltage AC220~240V 50/60Hz. When the TV set is not to be used for an extended period of time, it is advisable to disconnect the power cord from the power outlet.



WARNING!

High voltages are used in the operation of this set. Refer service to qualified service personnel.

Step 4

Switch on your TV set.

This TV set provides a self-automatic tuning function called "Plug & Play". The first time you switch on this TV set, it will automatically begin searching all of the available TV station in your reception area.

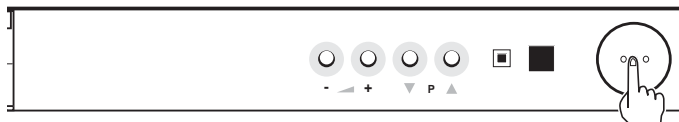

- Press the **Mains ON/OFF switch** on the front of the TV. Power indicator illuminates red to show the power is on. If the TV set remains in standby mode, press any of the following button:
- **Standby/Power-on button** of the remote control transmitter.
 - **Programme UP/DOWN** of the remote control transmitter or the TV set.
 - **1 to 9, 0 button** on the remote control transmitter.

It will automatically begin searching all of the available TV station in your reception area.
A welcome message will appear while Plug & Play is in operation.
To cancel this procedure, press the **MENU button**.

After completing the searching operation for all available stations, the TV set will return to normal TV mode and select the programme position "01" and displays the ending message on the screen.
Press any of the control buttons to make the ending message disappear.

- If additional channels become available (you move to another city or cable is installed), please follow the description "PRESETTING" on pages 12 and 13.

GENERAL OPERATION

Remote control

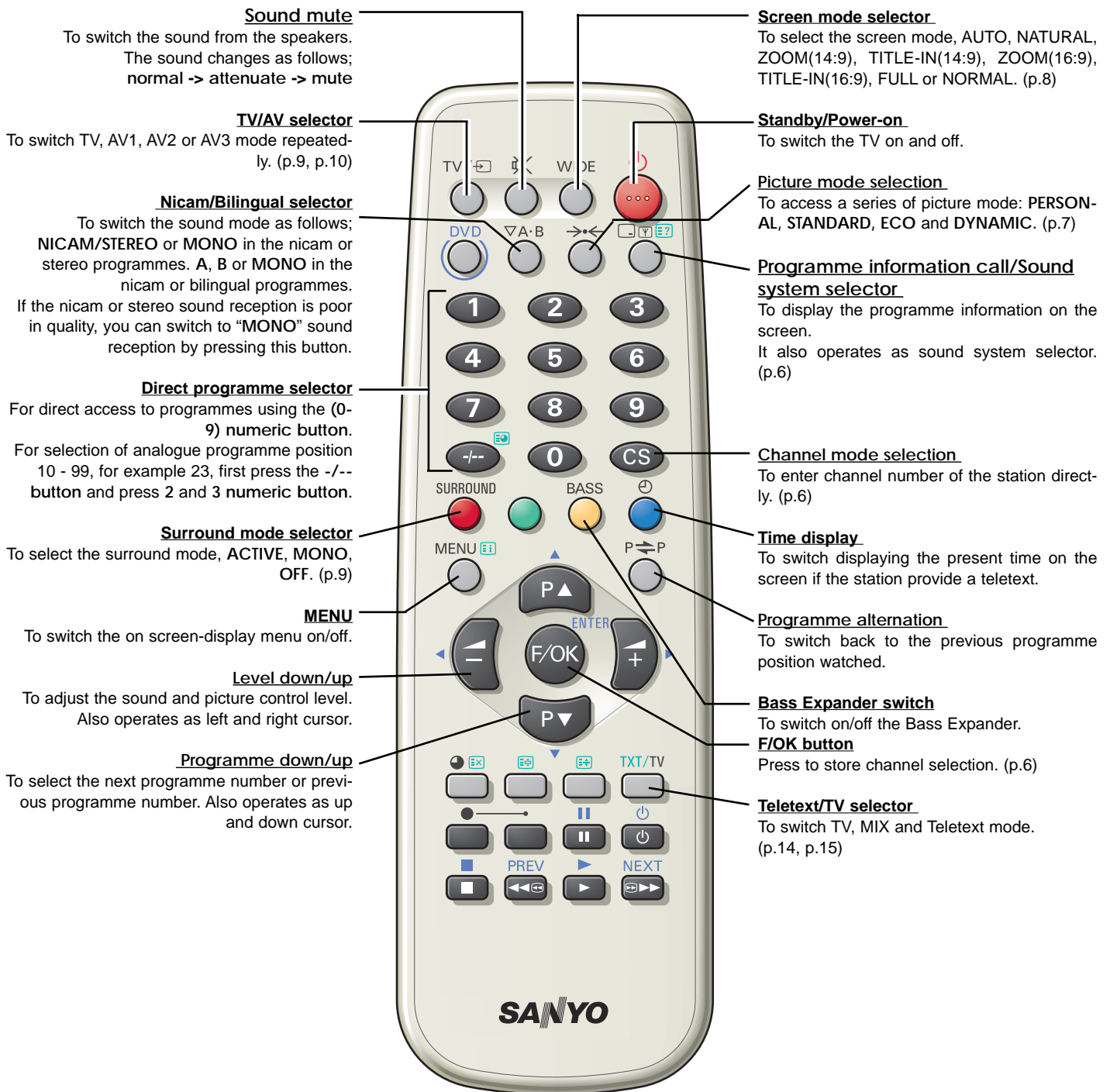

GENERAL OPERATION

Keys on the TV

Each button listed in this section has the same function as its corresponding button on the remote control.

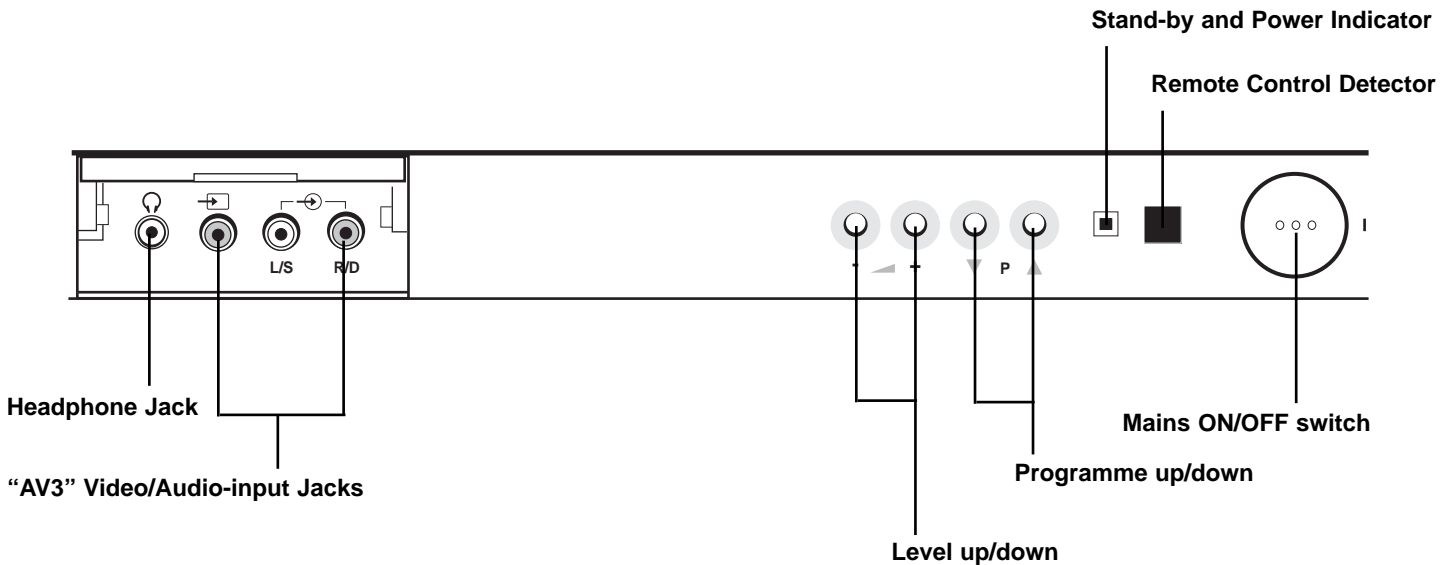

Operation

Switching-on/off with mains switch

- To turn the TV set ON, press the **Mains ON/OFF switch** on the front of the TV. The power indicator illuminates red to show the power is on.
- To turn the TV set OFF completely, press the **Mains ON/OFF switch** again.

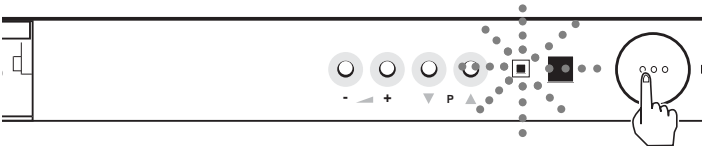

If no picture appears but the power indicator is on, press the **Standby/Power-on, P▲, P▼** or **0 - 9** button as the TV set is in the standby mode.

Switching into/from standby mode

- To switch the TV set into the standby mode, press the **Standby/Power-on button**.
The red power indicator illuminates more brightly.
- To switch the TV set ON from the standby mode, press any of the following buttons;
 - Standby/Power-on button** of the remote control transmitter.
 - Programme UP/DOWN** of the remote control transmitter or the TV set.
 - 1 to 9, 0** button on the remote control transmitter.



If you find the power indicator flashing, please turn the TV set off completely with the Mains ON/OFF switch and contact our service desk.



This warning is a sign to let you know that the power protection function of this TV set is now operating.

Auto Shut Off

This TV set will automatically switch into the standby mode, 10 minutes after a signal is no longer received. The time until the set will switch off is displayed on the screen.

OFF 0:10

When the TV set is switched on by using the ON-Timer function with no signal being received, this function will be ignored.

GENERAL OPERATION

Programme selection

- Select a programme position by using the **0 - 9 numeric buttons**. Use **-/-- button** first to select the 10 to 99 programme positions.
- Press the **Programme up** or **down** button to select the programme in sequence.

Direct channel selection

To select channels directly, please follow the below steps:

- 1 Press the **CS button**. The current channel number will be displayed on the screen.
- 2 ● If you do not know the channel number, press the **Programme up** or **down** to start channel searching. When a station is found searching stops automatically. If this is not the desired station repeat until the desired stations is found.
 - If you know the channel number, press the **CS button** again to change to "C--" whilst in the CS mode. And then enter the channel number by using the **(0-9) numeric buttons**.
 If you wish to select hyper channel number, select "H--" by pressing the **CS button**. Then enter the hyper channel number.
- 3 While the screen display is still visible, press the **F/OK button** to store your selection into the memory. The colour of the channel number changes white to yellow momentarily.

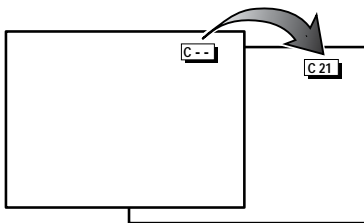

Sound volume control

To adjust the sound volume level, press the **Level up** / **down** .

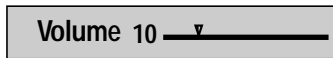

Programme information and sound system selection

Press the **Programme information call button** to display the programme information such as current programme number, stereo status, sound system and remains time if set the timer, for about 5 seconds. While the screen display is still on the screen, you can switch the sound system by pressing it again if the sound that is being received is of poor quality.

- S-1: B/G sound system**
- S-2: D/K sound system**
- S-3: I sound system**
- S-4: France SECAM L/L' system**

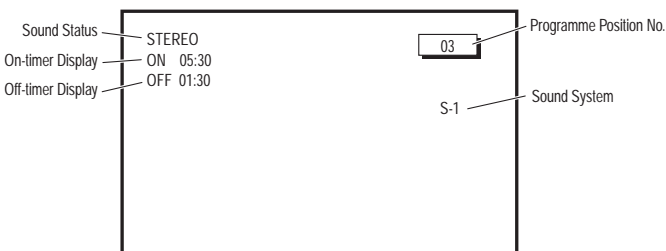

Picture and sound setting

Picture adjustment

- 1 Press the **MENU button**.
- 2 Select Picture by pressing the **Programme up** or **down button**.

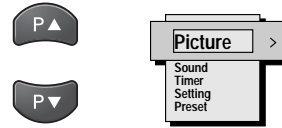

- 3 Press the **Level up button**.



- 4 Select from the following by pressing the **Programme up** or **down button**.

- Contrast** : To adjust the picture contrast.
- Brightness** : To adjust the picture brightness.
- Colour** : To adjust the picture colour.
- Tint** : To adjust the colour phase. (This appears when NTSC signals input.)
- Sharpness** : To adjust the picture sharpness.
- Text Bright** : To adjust the teletext brightness level.
- Memory** : To store the preference of the picture level into "PERSONAL" mode, see next chapter.

- 5 Adjust settings by pressing the **Level up** or **down button**.



- 6 To return to the normal TV mode, press the **MENU button** repeatedly.

Storing personal preferences into "PERSONAL" mode

- 1 Select memory in the Picture menu by pressing the **Programme up** or **down button**.

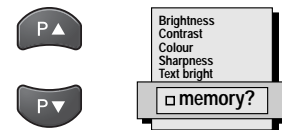

- 2 Press the **Level up button**, a tick appears in the box and the settings are stored.

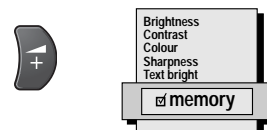

- 3 To return to the normal TV mode, press the **MENU button** repeatedly.

GENERAL OPERATION

■ Sound adjustment

- 1 Press the **MENU** button.
- 2 Select Sound by pressing the **Programme up** or **down** button.

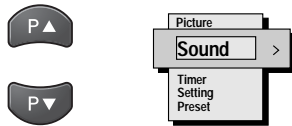

- 3 Press the **Level up** button.

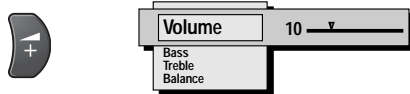

- 4 Select from the following by pressing the **Programme up** or **down** button.

- Volume** : To adjust sound volume..
Bass : To adjust low frequency sounds.
Treble : To adjust high frequency sounds.
Balance : To equalise the output from the left and right speakers.

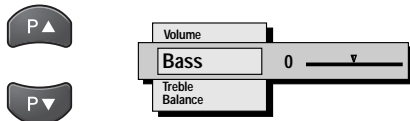

- 5 Adjust settings by pressing the **Level up** or **down** button.

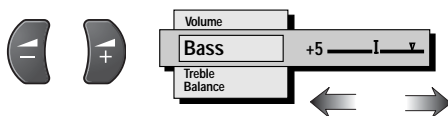

- 6 To return to the normal TV mode, press the **MENU** button repeatedly.

■ Picture mode selection and Personal preferences setting

This TV provides three predefined picture modes and one adjustable personal picture preference mode. You can choose your preferred picture mode by pressing the **Picture mode** button →*← repeatedly.

- PERSONAL** : Personal preference mode
STANDARD : Normal viewing mode
ECO : Low contrast, brightness and colour picture setting (Suitable for dimly lit rooms and gives a cinema-like effect when the lights are switched off, or Economical mode).
DYNAMIC : High contrast, brightness and colour picture setting (Suitable for brightly lit rooms).

Child lock

You can prevent small children from unexpectedly pressing buttons on the front of the TV set.

- 1 Press the **MENU** button.
- 2 Select "Setting" by pressing the **Programme up** or **down** button.

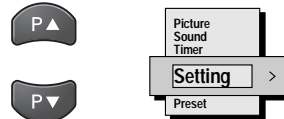

- 3 Press the **Level up** button.
Select "Child lock" by pressing the **Programme up** or **down** button.

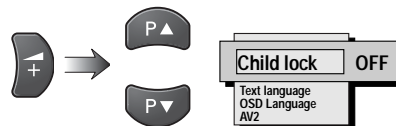

- 4 Select ON or OFF by pressing the **Level up** or **down** button.

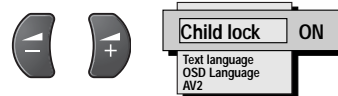

- 5 To return to the normal TV mode, press the **MENU** button repeatedly.

Selection of the OSD language

We prepare languages for the On-screen display as follows, you can choose own language in following steps.

- 1 Press the **MENU** button.
- 2 Select "Setting" by pressing the **Programme up** or **down** button.

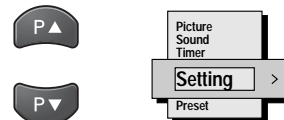

- 3 Press the **Level up** button.
Select "OSD Language" by pressing the **Programme up** or **down** button.

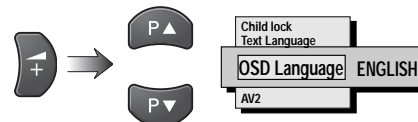

- 4 Choose language by pressing the **Level up** or **down** button.

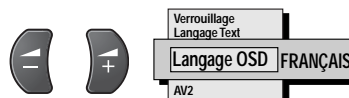

- 5 To return to the normal TV mode, press the **MENU** button repeatedly.

GENERAL OPERATION-SCREEN OPTION

SCREEN OPTIONS

WSS (Wide-Screen-Signalling)

This function is to be automatically set to the optimum screen mode for the wide screen television according to the aspect ratio bits of the picture format (16:9, 14:9, 4:3, etc.) on the receiving signal source.

To use this function, the picture mode should be selected to the AUTO mode.

This function is also effective in the AV mode. When you connect AV equipment which has the WSS function, the screen mode is automatically selected to the optimum screen mode.

■ Selection of screen mode

Today there are various transmission formats with different size ratios, e.g. 4:3, 14:9, 16:9 and video formats such as letterbox. Each of them can displayed differently depending on the picture mode selected.

Press the **WIDE** button to select the picture modes.

AUTO

It automatically switches to the optimum screen mode according to the WSS signal provided in the receiving signal source. If the signal does not have it, the TV keeps current screen mode. This setting may cause the picture to change when a different format is received e.g. when an advert is received.

NATURAL WIDE

4:3	14:9	16:9	Letterbox Video
Stretches the picture horizontally to fill the screen, the picture is more stretched at the edges.	The height is expanded to fill the whole screen.	The picture fills the screen and is proportionally correct.	The black bars top and bottom remain and the height is compressed to fit into the picture area.

ZOOM (14:9)

4:3	14:9	16:9	Letterbox Video
The correct picture width is maintained but the top and bottom are cropped.	Zooms in slightly cropping the top and bottom.	Zooms in slightly cropping the top and bottom.	The black bars top and bottom are smaller and the picture height is compressed slightly.

TITLE-IN (14:9)

4:3	14:9	16:9	Letterbox Video
As zoom (14:9), but bottom is compressed even more to allow subtitles to be seen.	As zoom (14:9), but bottom is compressed even more to allow subtitles to be seen.	As zoom (14:9), but bottom is compressed even more to allow subtitles to be seen.	As zoom (14:9), but bottom is compressed even more to allow subtitles to be seen.

ZOOM (16:9)

4:3	14:9	16:9	Letterbox Video
The correct picture width is maintained but the top and bottom are cropped.	Zooms in slightly cropping the top and bottom.	Zooms in slightly cropping the top and bottom.	The black bars top and bottom are smaller and the picture height is compressed slightly.

TITLE-IN (16:9)

4:3	14:9	16:9	Letterbox Video
As Zoom (16:9), but bottom is compressed even more to allow subtitles to be seen.	As Zoom (16:9), but bottom is compressed even more to allow subtitles to be seen.	As Zoom (16:9), but bottom is compressed even more to allow subtitles to be seen.	As Zoom (16:9), but bottom is compressed even more to allow subtitles to be seen.

FULL

4:3	14:9	16:9	Letterbox Video
The whole screen is filled stretching the width.	The whole screen is filled stretching the height slightly at the edges.	The whole screen is filled with the correct picture ratio.	The black bars top and bottom are present and the height is compressed.

NORMAL

4:3	14:9	16:9	Letterbox Video
The correct ratio is maintained with black bars on the left and right.	Black bars left and right, picture height is stretched.	Black bars left and right, picture height is stretched.	Black bars left, right, top and bottom.

SOUND OPTIONS/USE OF AV EQUIPMENT

SOUND OPTIONS

■ Selection of surround mode

This TV provides an active 3D surround processor which can realise a 3 dimensional sound effect when receiving a standard stereo signal or monaural signal.

You can choose following 3D surround modes by pressing the **SURROUND** button repeatedly.

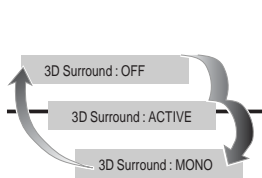

- ACTIVE** : Normal 3D surround mode, you will feel optimum 3D surround effect.
- MONO** : This mode is especially prepared for Nicam-mono broadcasting. Select this mode, when you can not get the 3D surround effects even if the status is Nicam stereo. You may feel 3D surround effect.
- OFF** : To switch off 3D surround effect.

■ Guidance for the best enjoyment of active 3D surround

Optimum positioning

- Sit at a distance of approximately 2 to 4 meters from the TV set.
- Listen facing the centre of the TV set.
- Remove any obstructions between you and the TV set.

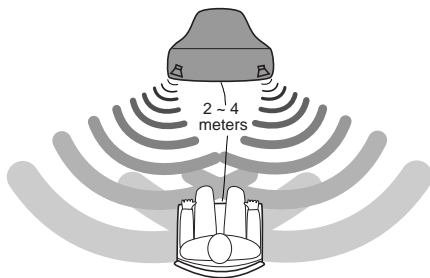

USE OF AV EQUIPMENT

You can connect a VCR, S-VHS VCR, Satellite Tuner, PAY TV Decoder, DVD or Camcorder to this TV via the SCART terminals and the AV terminals.

■ Use of rear AV2 input terminal

If you want to use a VCR which is equipped with the S-VHS capability to obtain the best performance, you should connect the Scart Terminal of AV2 and select the S-Video mode in the "AV2 mode" using the following procedures.

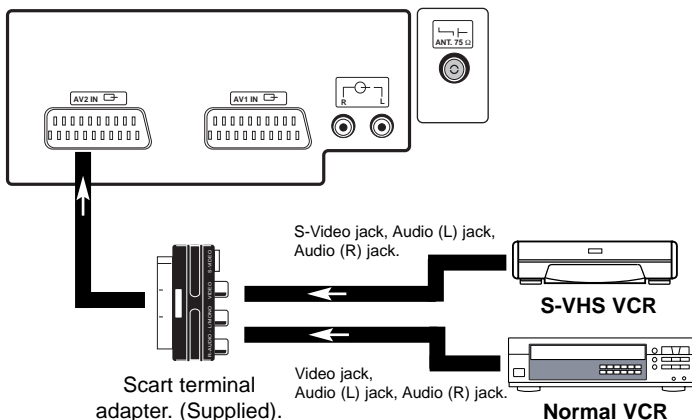

● Setting of AV2 input mode

- 1 Press the **MENU** button.
- 2 Select "Setting" by pressing the **Programme up** or **down** button.

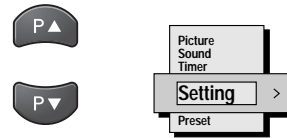

- 3 Press the **Level up** button.
Select "AV2" by pressing the **Programme up** or **down** button.

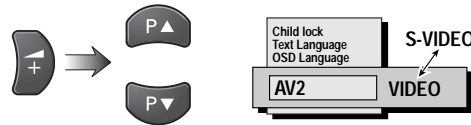

- 4 Select "S-VIDEO" or "VIDEO" by pressing the **Level up** or **down** button.

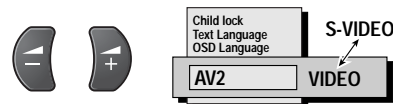

- 5 To return to the normal TV mode, press the **MENU** button repeatedly.

- ✓ While a S-VIDEO terminal is connected, normal Video input of the AV2 terminal should not connected to avoid the signal mixed.
- ✓ To connect to S-VIDEO or normal Video input, please use scart terminal adapter. (Supplied).
- ✓ This scart terminal is used for input only.

■ Selection of sound track from the equipment

By pressing the **Nicam/Bilingual selector** repeatedly, you can select the sound track L(Left), R(Right) or L/R from the equipment connected to the scart terminals or the AV terminal.

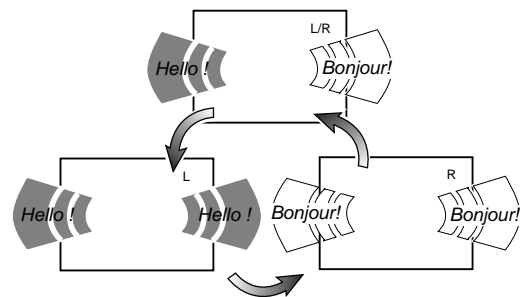

■ Selection of colour system in the AV mode

By pressing the **Color** button repeatedly in the AV mode, the colour system mode will be changed as follows;

AUTO -> PAL -> SECAM -> NTSC4.43 -> NTSC3.58

USE OF AV EQUIPMENT

■ Use of front AV3 terminal

This TV provides one pair of AV input terminal on the front panel. It is very convenient for use as a game or camcorder connection.

- 1 Connect an RCA cable from the front AV terminal (AV3) to a camcorder or to game equipment.
- 2 Press the **TV/AV** button repeatedly to select the AV3 mode.

☞ For monaural units, connect the sound cable to the L-socket.

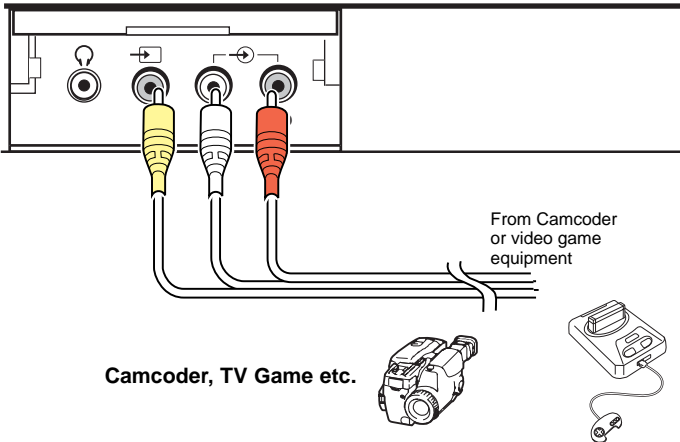

■ Use of Headphone

The 3.5mm mini-stereo jack socket located behind the door of the TV can be used for headphone.

When the headphone are inserted the sound from the TV speakers is muted.

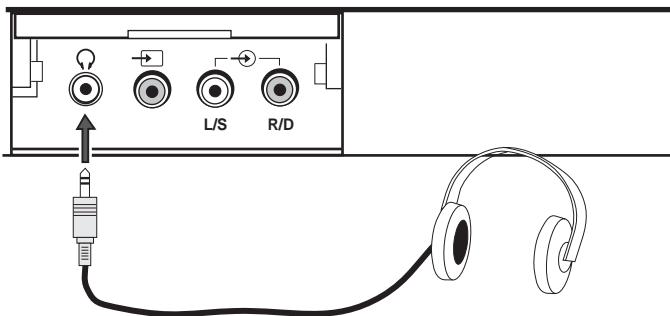

■ Use of Audio Output Jacks

This TV provides the audio monitor output jacks on the rear of the cabinet back. You can connect your audio equipment to these jacks.

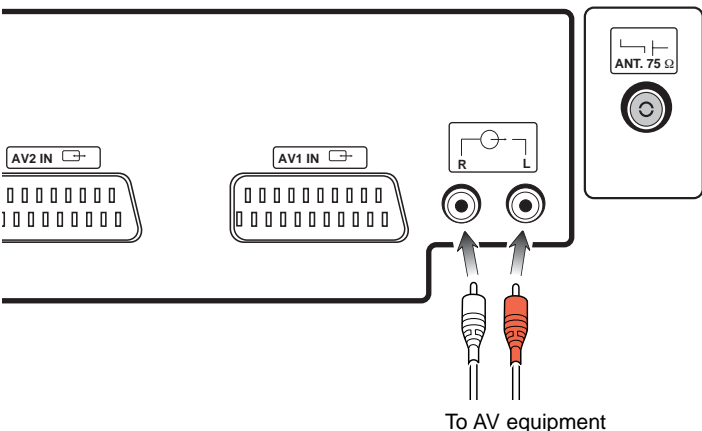

■ VCR/DVD controls

This remote control transmitter has been designed to be used in conjunction with selected SANYO VCR's and DVD players. Some SANYO VCR's and DVD players may have their own functions, so please refer to the individual instruction booklet when using this remote control to ensure compatibility.

Some of the keys are used for both the VCR and DVD player. The symbols indicated with blue are for the keys to control the DVD player. When use the DVD player with this remote control, first press and hold the **DVD** button and then press your desired control button each time.



	VCR	DVD
	Power	Power
	Play	Play
	Pause	Pause
	Stop	Stop
	Fast/Cue	Next chapter selection
	Rewind/Review	Previous chapter selection
	Record, press both button at same time.	n/a
DVD	n/a	DVD command mode selection
OK	n/a	Enter
	n/a	Cursor selection

TIMER

TIMER

■ On-timer setting

The On-timer will switch-on from the standby mode or change programme positions when the selected time times has elapsed.

- 1 Press the **MENU** button.
- 2 Select "Timer" by pressing the **Programme up** or **down** button.

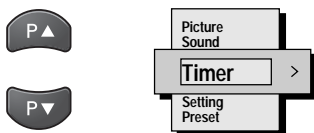

- 3 Press the **Level up** button.
Select "ON-Timer" by pressing the **Programme up** or **down** button.

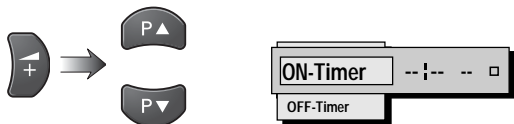

- 4 Press the **Level up** button to select the time setting column (---:--).
Select a time period by pressing the **Programme up** or **down** button.

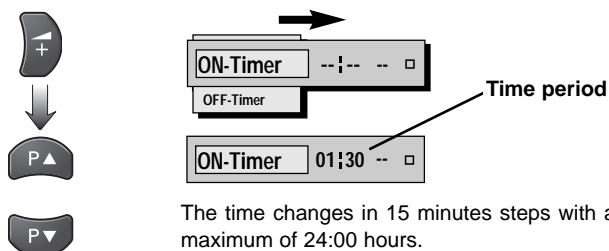

- 5 Press the **Level up** button to select the start up programme position column.
Select start up programme position by pressing the **Programme up** or **down** button.

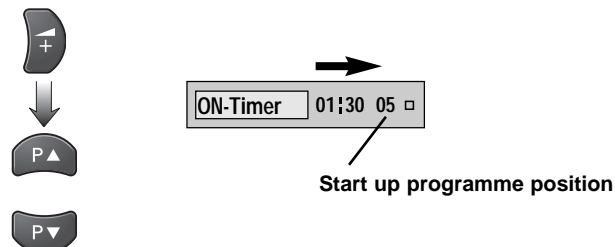

- 6 Press the **Level up** button once to set the timer. The colour of the timer display changes green. To cancel the On-timer, press the **Level up** button. The colour of the timer display changes yellow.

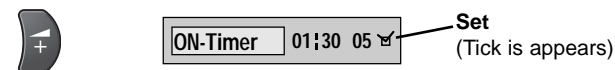

If you switch your TV into standby mode, it will switch on after the time elapses. If you do not switch into standby mode, it will switch to the selected programme position.

If the TV set is switched on by on-timer function, the TV set will automatically switch into the standby mode in 3 hours if no keys are pressed. This is a safety feature to ensure that you are aware that the TV set is functioning.

- 7 To return to the normal TV mode, press the **MENU** button repeatedly.

■ Off timer setting

The Off timer will switch the TV into the standby mode when the selected time has elapsed.

- 1 Press the **MENU** button.
- 2 Select "Timer" by pressing the **Programme up** or **down** button.

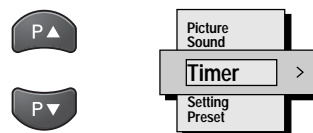

- 3 Press the **Level up** button.
Select "OFF-Timer" by pressing the **Programme up** or **down** button.



- 4 Press the **Level up** button to select the time setting column (---:--).
Select a time period by pressing the **Programme up** or **down** button.

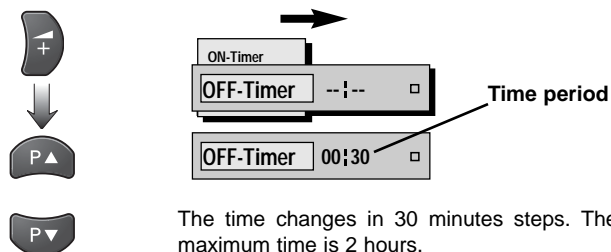

- 5 Press the **Level up** button once to set the timer. The colour of the setting column numbers changes to green. To cancel the On-timer, press the **Level up** button. The colour of the setting column numbers to yellow.

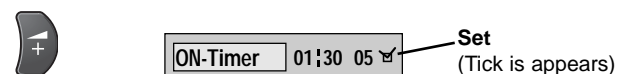

- 6 To return to the normal TV mode, press the **MENU** button repeatedly.

If you have set the off timer, then one minute before the TV switches off, the count down display appears on the screen.

✦ If the TV set is switched off by the Mains ON/OFF switch, a power failure occurs or entering the tuning mode, the timer settings will be cancelled.

PRESETTING

PRESETTING

■ Presetting new channels

Up to 100 broadcast stations in your reception area can be stored in the electronic memory.

There are two ways to tune in new channels.

1. Automatic Tuning (the basic way):

Automatically presets all of available stations in sequence as found.

2. Semi-Auto Tuning:

Manually presets a station for each programme position.

■ AUTO (Automatic tuning)

All receivable channels are automatically found and stored.

1 Press the **MENU** button.

2 Select "Preset" by pressing the **Programme up** or **down** button.

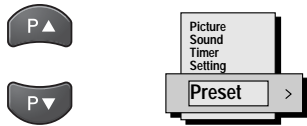

3 Press the **Level up** button.

Select "Tuning" by pressing the **Programme up** or **down** button.



4 Press the **Level up** button to select the tuning option column.

Select "AUTO" by pressing the **Programme up** or **down** button.



5 Select "CH:--" by pressing the **Programme up** or **down** button.

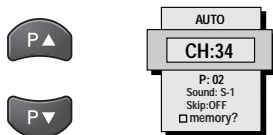

Important !

About Sound System: Always select "S-1" of the sound system.

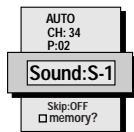

6 Press the **Level up** button to start the automatic tuning.

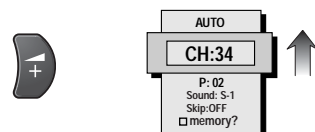

To cancel this tuning operation, press the **MENU** button.

After completing this procedure, the TV set returns to normal TV mode and selects programme position "01".

✗ **Auto Sort** menu in the Preset menu is not used in this model.

✗ The colour system (PAL, SECAM or NTSC4.43) is selected automatically.

✗ When entering the preset mode at the AUTO, NATURAL, ZOOM, TITLE IN, NORMAL or FULL screen mode, the screen mode will change to NATURAL mode automatically.

IMPORTANT

If the tuning functions do not operate, please check that the option setting "Prohibition" is set to OFF, see on page 15.

■ SEMI (Semi-automatic tuning)

Use to preset a receivable channel in any desired programme position.

1 Press the **MENU** button.

2 Select "Preset" by pressing the **Programme up** or **down** button.

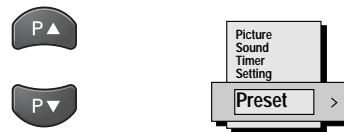

3 Press the **Level up** button.

Select "Tuning" by pressing the **Programme up** or **down** button.



4 Press the **Level up** button to select the tuning option column.

Select "SEMI" by pressing the **Programme up** or **down** button.



5 Select the programme position column by pressing the **Programme up** or **down** button. Then select the programme position where you want to store a channel by pressing the **Level up** or **down** button.

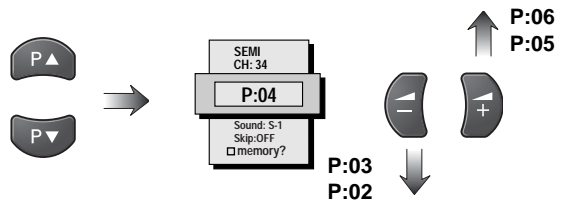

6 Select "CH:--" by pressing the **Programme up** or **down** button.

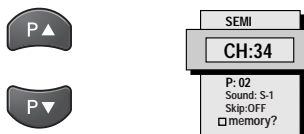

If you know the channel number of the station, press the **CS** button first then enter the channel number with 2 digits entry, i.e. channel 25, enter 2 and 5. To select a channel in another channel band, "C--" or "H--", press the **CS** button once and then enter the 2 digits key numbers.

PRESETTING

- 7 Press and release the **Level up** or **down** button to start searching.

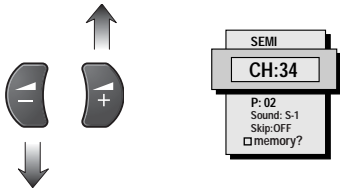

The **Level up** button will move tuning toward the higher frequencies, and the **Level down** button will move tuning toward the lower frequencies.

Once a station is located, tuning will automatically stop. Continue till desired channel is located.

Important !

About Sound System: Always select "S-1" of the sound system.

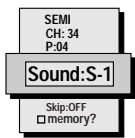

- 8 To store your preferred channels, select "memory?" by pressing the **Programme up** or **down** button and then press the **Level up** button. The memory shows that the memorisation is completed.

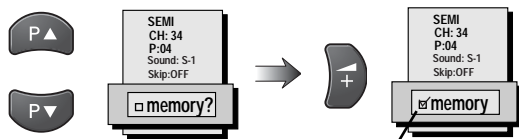

Memory (Tick is appears)

Repeat steps 5 to 8 for other desired channels.

- 9 To return to the normal TV mode, press the **MENU** button repeatedly.

■ Fine tuning

- 1 Press the **MENU** button.
- 2 Select "Preset" by pressing the **Programme up** or **down** button.

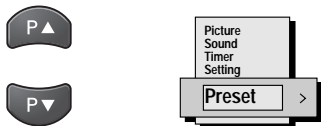

- 3 Press the **Level up** button. Select "Fine Tuning" by pressing the **Programme up** or **down** button.

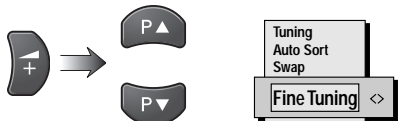

- 4 Adjust fine tuning by pressing the **Level up** or **down** button.



- 5 To return to the normal TV mode, press the **MENU** button repeatedly. The tuning will be stored when you exit from the menu.

■ Channel Swapping

Use the channel swapping feature to swap the channels between two stored programme positions. This feature is particularly useful after automatic tuning.

You have to choose a programme that you wish to swap on the TV set. For example, Swap programme position 4 and 12.

- 1 Select programme position 4.
- 2 Press the **MENU** button.
- 3 Select "Preset" by pressing the **Programme up** or **down** button.

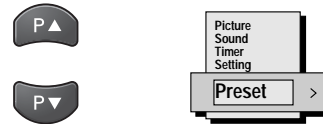

- 3 Press the **Level up** button. Select "Swap" by pressing the **Programme up** or **down** button.



- 4 Enter the programme number using the (0-9) numeric buttons. Press the **Level up** button and the channels are swapped.

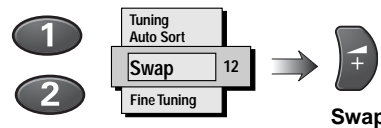

■ Skip Channels

When there is a position you do not use, Position 4 for example, by setting the Skip channel function it is possible to jump over this position, when you are selecting a channel using the **Programme up** or **down** button.

- 1 Select programme position that you want to skip.
- 2 Select "Skip" option in the Tuning column. Select "Skip :ON" or "Skip:OFF" by pressing the **Level up** or **down** button.

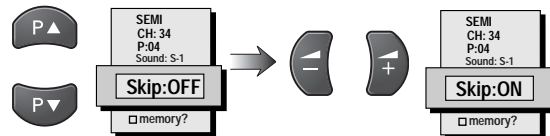

- 3 To store skip channels, select "memory?" by pressing the **Programme up** or **down** button and then press the **Level up** button. The memory shows that the memorisation is completed.

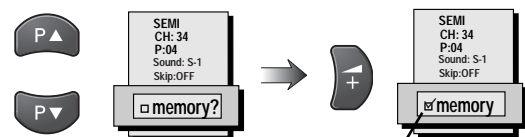

Memory (Tick is appears)

- 4 To return to the normal TV mode, press the **MENU** button repeatedly.

TELETEXT

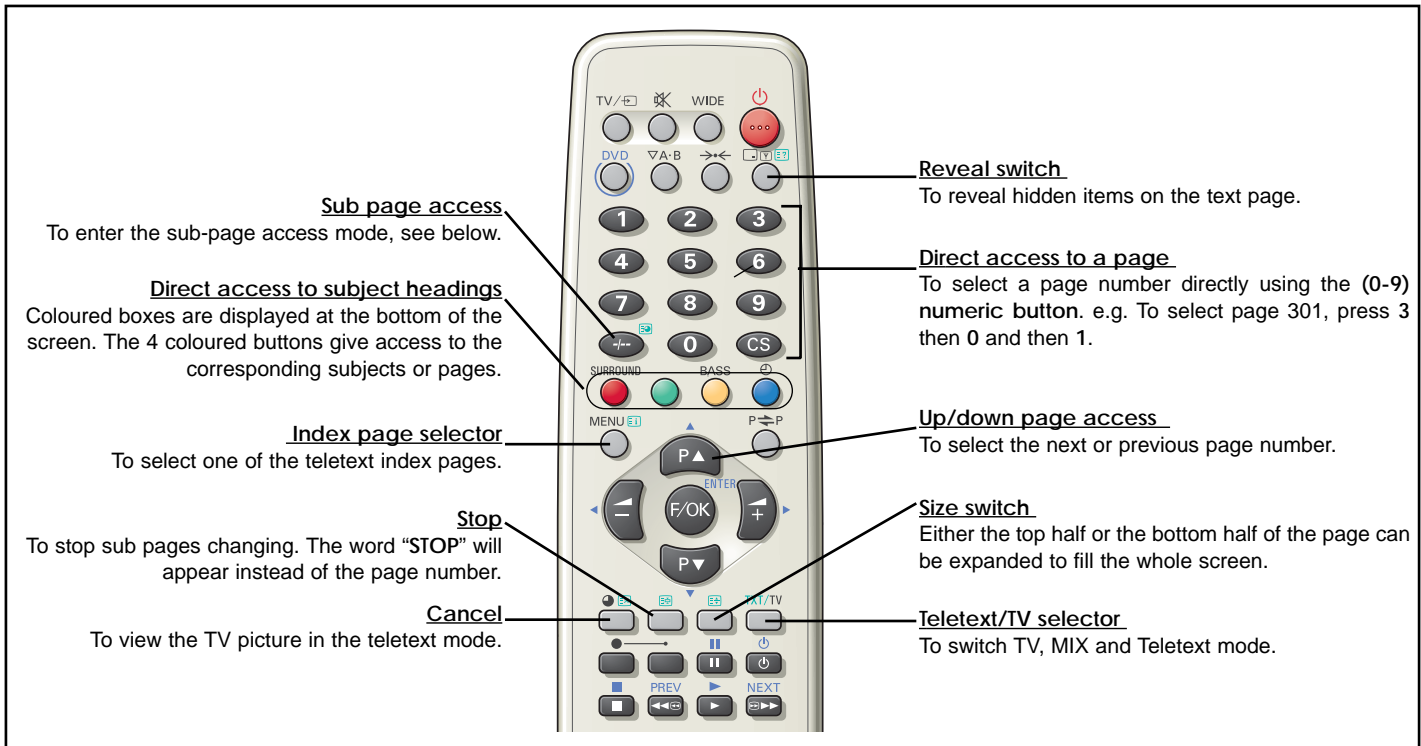

■ Selection of teletext language

- 1 Press the **MENU** button in the normal TV mode to display the main menu.
- 2 Select the "Setting" menu by pressing the **Programme up or down** button.

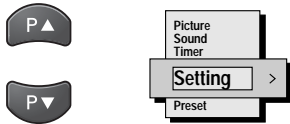

- 3 Press the **Level up** button. Then select "Text Language" by pressing the **Programme up or down** button.

Select the "WEST" or "EAST" by using the **Level up or down** button according to the country in which you live.

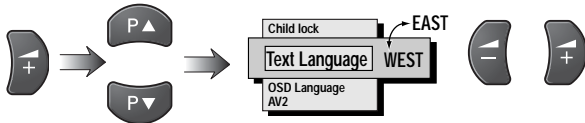

- 4 Press the **MENU** button repeatedly to exit from the menu.

■ Picture & sound in the teletext mode

- **Picture and teletext brightness controls in the teletext mode**
You can not control the picture and teletext brightness in the teletext mode. You must first switch back to the TV mode and then adjust the picture control or set the teletext brightness level.

■ How to set the teletext brightness level

- 1 Press the **MENU** button in the normal TV mode to display the main menu.
- 2 Select "Picture" by pressing the **Programme up or down** button.

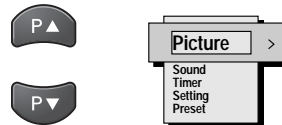

- 3 Press the **Level up** button. Select the "Text Bright" menu using the **Programme up or down** button.

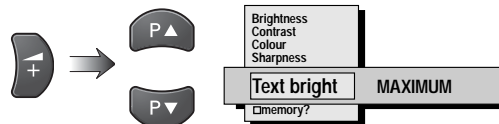

- 4 Select one of the 3 teletext brightness levels either "MAXIMUM", "CENTRE" or "MINIMUM".
- 5 Confirm the selected teletext brightness level by switching to the teletext mode by pressing the **TXT/TV** button. Press the **MENU** button to exit from the menu.

● Sound volume control

Only sound volume and muting can be controlled in the teletext mode. However they are not displayed on the screen.

TELETEXT/OTHERS

■ Operation

■ Sub page access

With a text page selected which has sub pages, you may wish to read a known sub page number.

- 1 Press the **⏏** button in the teletext mode. "Sub code ----" will be displayed on top of the screen.
- 2 Enter the sub page number using the **(0-9) numeric buttons**. e.g.. 0004.
- 3 Press the **⏏** button to return the normal TV picture. Immediately when the entered sub-coded page is reached the page number will appear on the TV picture.
- 4 Press the **TXT/TV** button to view the sub-coded page.

■ Updated pages

Some text pages are updated such as latest sports scores or traffic news. Select a latest page.

- 1 Press the **⏏** button in the teletext mode to view the TV picture. When the page is updated the page number will appear over the normal TV picture.
- 2 Press the **TXT/TV** button to view the updated page.

✓ If the page has sub pages the number will appear when the sub page is changed.

✓ When switching from TV mode at the AUTO, NATURAL, ZOOM, TITLE IN or FULL screen mode to teletext mode, the teletext screen will change to FULL screen mode automatically.

When the teletext service is not transmitting with the FLOF, 4 coloured page numbers will appear at the bottom of the screen instead of the topics.

Teletext reception

If your aerial signal is poor, the teletext reception may be poor.

■ Option setting

This TV set allows you to set up the following special functions.

■ Maximum volume setting and prohibition of pre-setting

Sets the current volume as the maximum volume level and prohibition of the tuning.

PROHIBITION OFF or PROHIBITION ON

■ Start up programme position

Presets the programme position when the set is switched on.

- | | |
|---------------------------|---------------------------------|
| START POSITION OFF | → Last programme position start |
| START POSITION P1 | → Programme position "1" start |
| START POSITION P2 | → Programme position "2" start |
| START POSITION P3 | → Programme position "3" start |
| START POSITION P4 | → Programme position "4" start |
| START POSITION P5 | → Programme position "5" start |
| START POSITION P6 | → Programme position "6" start |
| START POSITION P7 | → Programme position "7" start |
| START POSITION P8 | → Programme position "8" start |
| START POSITION AV1 | → "AV1" start |

SETTING PROCEDURE

- 1 Press and hold the **⏏** button on the **Remote control handset** and then press the **CH ▲** button on the **TV set**.
- 2 Use the **P ▲** or **P ▼** button to highlight the desired option item from the menu, and select the mode by pressing the **▶ + or -** button.
- 3 Press the **⏏** button to exit from the menu.

PROHIBITION ON
START POSITION OFF

■ Specifications

Power source	AC 220-240V 50/60Hz
Television system	System B/G, D/K, I, L/L'
Colour system	PAL/SECAM/NTSC4.43 on air (Automatic colour system selection) PAL/SECAM/NTSC4.43/NTSC3.58 in AV mode
Channel coverage	VHF: 0-11, 5A (Australia) 1-11 (New Zealand) UHF: 28-69 (Australia) 21-69 (New Zealand) CATV: S1-S41, X, Y, Z, Z+1, Z+2

Aerial input impedance 75 ohm

Rear AV Input Terminal

AV1

CENELEC Standard

Input: Composite video, RGB and audio-L/R
Output: Audio-L/R (without TV-output)

AV2

CENELEC Standard

Input: Composite video, RGB, S-VHS and audio-L/R
Output: Monito-output with composite video and audio-L/R

Front AV Input Terminal

AV3

Phone Jack : Video input and Audio-L/R input.

Rear Monitor Output Terminal

Phone Jack : Audio-L/R monitor outputs.

Headphone jack: Mini Stereo jack X 1

Speaker	6 cm x 12 cm x 2 pcs.
Sound Output (RMS)	10W + 10W

Picture tubes (inches)	32
Dimensions (WxHxD mm)	880 x 575 x 549
Weight	approx. 55Kg

Specifications subject to change without notice.

■ Servicing

Your television is fully transistorised and does not contain any user serviceable components.

Removal of the cabinet cover may expose you to dangerous voltages. Refer all servicing to qualified service personnel.

Unplug the television receiver from the wall outlet and refer servicing to qualified service personnel under the following conditions:

- If the power cord or plug is damaged.
- If liquid has been spilled into the television receiver.
- If television receiver has been exposed to rain or water.
- If the television receiver has been dropped or the cabinet has been damaged.
- If the television receiver exhibits a distinct change in performance.
- If the television receiver does not operate normally by following the operating instructions.

Adjust only those controls that are covered in the operating instructions as improper adjustment of other controls may result in damage. This will often require extensive work by a qualified technician to restore the television receiver to normal operation.

When replacement parts are required, have the service technician verify that the replacements he uses have the same safety characteristics as the original parts. Use of manufacturers specified replacements can prevent fire, shock or other hazards.



■ Helpful hints

■ NO PICTURE, NO SOUND

- Check if TV is plugged in.
- Try a different channel, if OK, probably station trouble.

■ POOR PICTURE, SOUND OK

- Adjust BRIGHTNESS control.
- Adjust FINE TUNING control.
- Check aerial connections

■ NO COLOUR, PICTURE OK

- Adjust COLOUR control.
- Adjust FINE TUNING control.
- Is the programme in colour ?

■ WEAK PICTURE

- Check aerial connections on back of set.
- Check aerial for broken wires.
- Re-orient aerial.

■ The following faults are not caused by the receiver:

"GHOSTS"

Reflections of signals from mountains or high buildings will cause multiple images, called "Ghosts". These abnormal conditions can be reduced to minimum by repositioning aerial or by installing a new one suited for your area.

"INTERFERENCE"

Interference may be caused by electrical appliances, car ignition systems, etc. This should normally be a temporary condition, but should this interference persist, contact your dealer.

SANYO