

SANYO

**Instruction
Manual**

**Colour
Television**

Model CPP2930TX
CPP2930
CPP2530TX
CPP2530
CZP2930TXN
CZP2930
CZP2530TXN
CZP2530
CAP2930TXN
CAP2530N

**STEREO(NICAM)*
SURROUND
TELETEXT(FLOF)**
S-TERMINAL
VIDEO MULTI TERMINAL
(PAL/NTSC/NTSC4.43)**

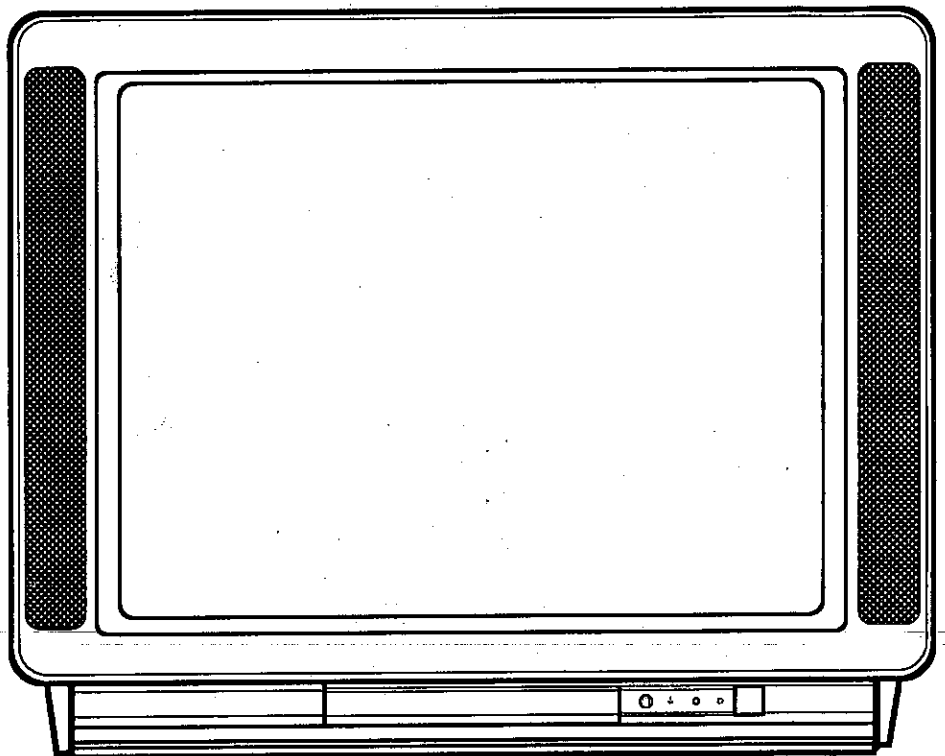

FUZZY LOGIC PICTURE CONTROL

- * Model CZP2930TXN and CZP2530TXN – Equipped with NICAM Digital Stereo Decoder.
Model CAP2930TXN and CAP2530N – Equipped with NICAM Digital Stereo Decoder and West Germany Stereo Decoder.
- **Model CPP2930, CPP2530, CZP2930, CZP2530, CAP2530N – Not equipped with Teletext Decoder.
(optional Teletext Decoder Type No. TX-240)

Contents

Warning.....	2
Precautions.....	2
Aerial Connection.....	2
Features.....	3
Controls.....	4
Operation of the TV set.....	4
Remote Control Operation.....	6
Presetting of Stations.....	10
Inserting Channels and Deleting Channels.....	11
Teletext Use.....	12
Connecting other Equipment.....	16
Specifications.....	20

Warning

To prevent fire or shock hazard, do not expose the unit to rain or moisture.

High voltages are used in the operation of this TV set. Do not remove the cabinet back from your set. Refer servicing to qualified service personnel.

Precautions

When the TV receiver is not to be used for an extended period of time, it is advisable to disconnect the AC power cord from the AC outlet.

Electric Mains

The receiver is designed to operate on an A.C. mains supply of 220-240 volts 50Hz.

Aerial Connection

Connect the cable with a plug from a UHF (or VHF) aerial to the aerial socket on the cabinet back.

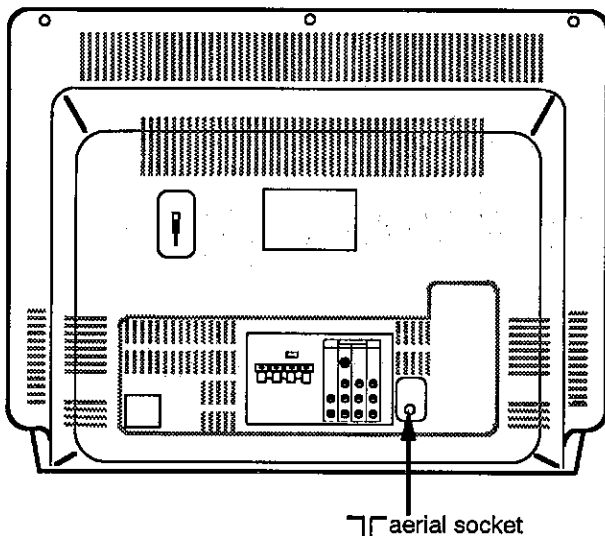

For all aerial circuit problems please consult your local dealer.

Features

■ Hi-Fi Stereo Sound Circuit with Surround Circuit.

It's easy to enjoy TV and video sound with the Surround effect.

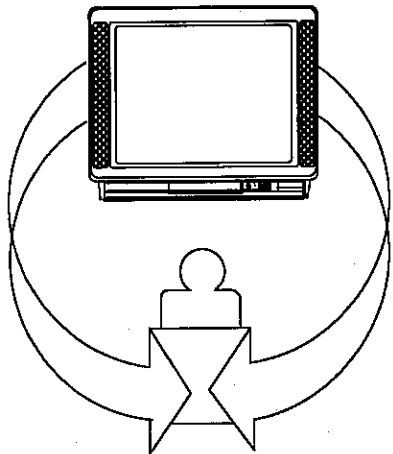

Surround System

The sounds that we hear in a natural listening environment consist of those which reach our ears directly from the sound source, and those which reach us indirectly after being reflected off of the floor, walls and other surrounding objects. The Surround System electrically produces these direct and indirect sounds, then sends them through speakers to surround the listener with sound that is rich in stereo presence.

■ This AV Television Allows Free System Expansion

Two S-terminals are provided.

Three video/audio inputs, one audio monitor output and one TV output (video and audio) enable easy VCR connection for tape playback and recording.

■ Video Multi Terminal

The AV input terminal of this TV set enables playback for VCRs and video disc players which employ the PAL system, NAP system (PAL-60Hz), NTSC system and NTSC4.43 system.

■ Model CPP2930TX, CPP2530TX, CZP2930TXN, CZP2530TXN and CAP2930TXN are equipped with Teletext Decoder.

■ Fuzzy Logic Picture Control

Fuzzy logic picture control automatically adjusts for an optimum picture by matching video image details to room brightness.

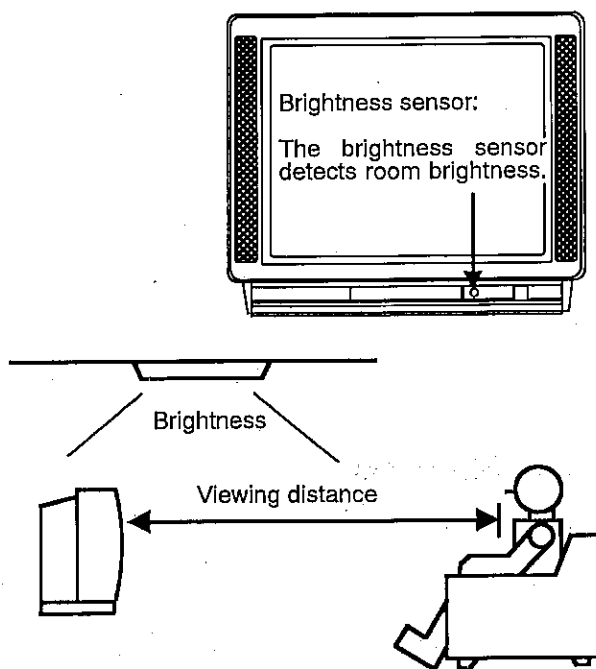

Video playback automatically adjusted to the viewing area is easier on the eyes.

The brightness sensor located on the front of the TV set constantly checks the brightness of the room. Fuzzy logic then selects the optimum picture quality for the image pattern based on both preset viewing distance (distance from the viewing position to the screen) and room brightness data.

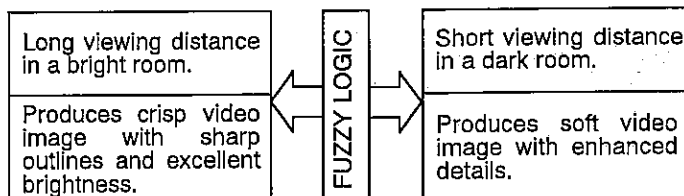

Video image component detection provides playback with optimum picture quality.

Picture quality and colour are balanced and noise is eliminated by detecting video signal components such as frequency, brightness, and black or white components.

Controls

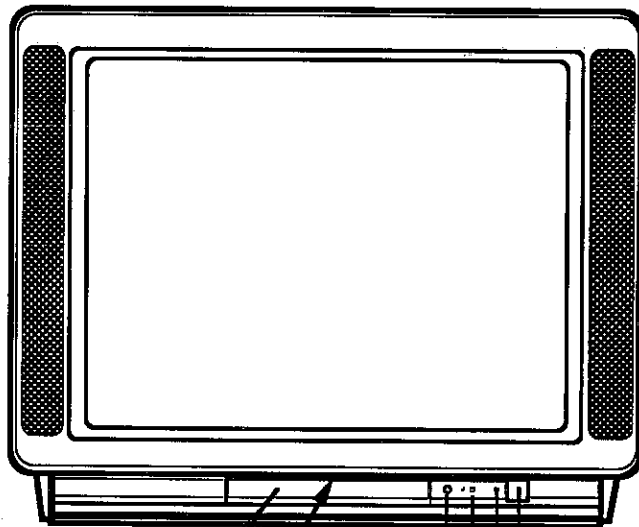

Press to open.

1 Main ON/OFF switch
 Remote control detector
 Standby and Power indicator
 Brightness sensor

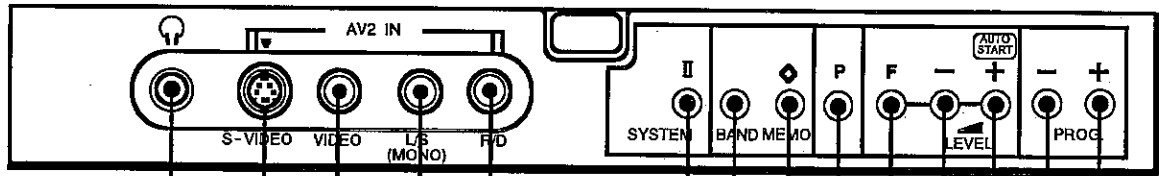

22 Headphone jack
 S-VIDEO input jack (AV2)
 VIDEO input jack (AV2)
 AUDIO (Left) input jack (AV2)
 AUDIO (Right) input jack (AV2)

Colour system selector (AV mode only) 21

19 BAND

18 PRESET

20 MEMORY

4 LEVEL

3 FUNCTION SELECT

2 Programme selector

Operation of the TV set

SWITCHING ON/OFF

To turn on the TV :

Press Main ON/OFF switch 1 .

To turn off the TV:

Press the Power ON/OFF button 1-1 on the remote control transmitter, and the TV changes to the standby mode. During the standby mode, the standby and power indicator illuminates more brightly than during the power-ON mode.

Press this button 1-1 to turn off the unit for short periods of the time.

To turn on the TV from the standby mode:

Press one of these button.

- Power ON/OFF 1-1 of the remote control transmitter.
- Programme Selector 2 or 2-1.
- Programme UP/DOWN 2-2 of the remote control transmitter.

To cut off the mains power completely:

Press the Main ON/OFF switch 1 .

Important ! Be sure to set the Main ON/OFF switch 1 to the off position, if the power failure occurs while viewing.

AUTO SHUT OFF

This TV set incorporates the AUTO SHUT OFF function. Even if the TV is left on after you have gone to sleep, the TV set changes to the standby mode within 10 minutes after all broadcasts have ended.

Note : AUTO SHUT OFF also functions for the AV mode even when there is no signal being transmitted.

The remaining time for AUTO SHUT OFF is displayed on the screen.

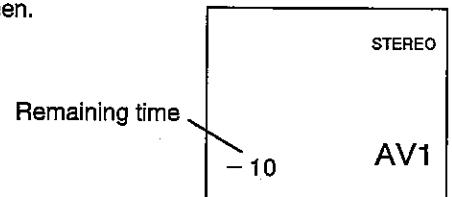

PROGRAMME SELECTION

Press the right side (+) of the programme selector 2 of the TV set, and the TV set will step up to the next station, i.e ; 1, 2, 3 ...59, VCR, 1, 2, 3

Press the left side (-), and the TV set will step down to the previous station.

Operation of the TV set

SOUND VOLUME ADJUSTMENT

To adjust the sound volume, press + or - LEVEL ④ button.

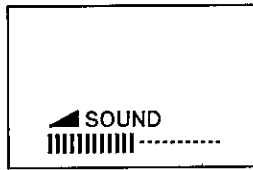

PICTURE AND AUDIO ADJUSTMENT

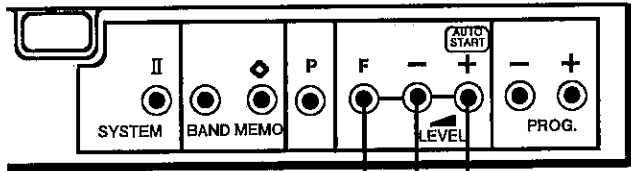

FUNCTION SELECT ③ LEVEL ④

1 Press FUNCTION SELECT ③ button to select a control function. Each time FUNCTION SELECT button is pressed, the control function changes as follows.

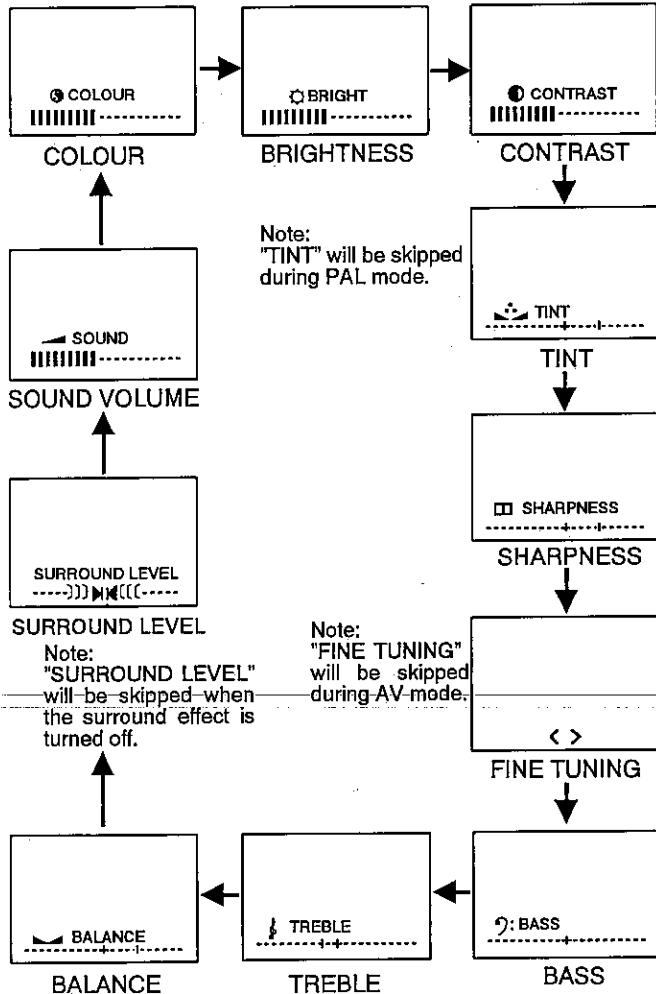

2 Press LEVEL (+ or -) ④ button to adjust each control level.

20 Memory ◇

This function lets you store the settings (for colour, brightness, contrast, video tone, tint, sound volume, bass, treble, balance and surround effect) in memory for both picture and the sound, and these setting levels can be recalled by pressing Normalization →← 15 button of the Remote Control Transmitter.

To store the picture and sound settings;

1. Set the picture and sound to the desired levels.

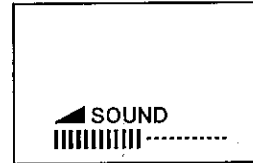

2. Press the MEMORY ◇ 20 button while the Control Function display is still visible on the screen.

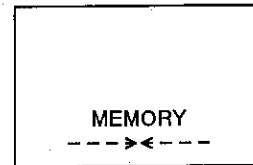

When the Memory button is pressed, "MEMORY" is displayed on the screen.

Note: The control settings will not be saved if the Memory button is pressed after the Control Function display has left the screen.

22 Headphone Jack 🎧

Insert the headphones plug into this jack to listen to either stereo or monaural sound via a headphones set.

Note: No sound will be heard from the speakers when the headphones plug is connected to this jack.

Remote Control Operation

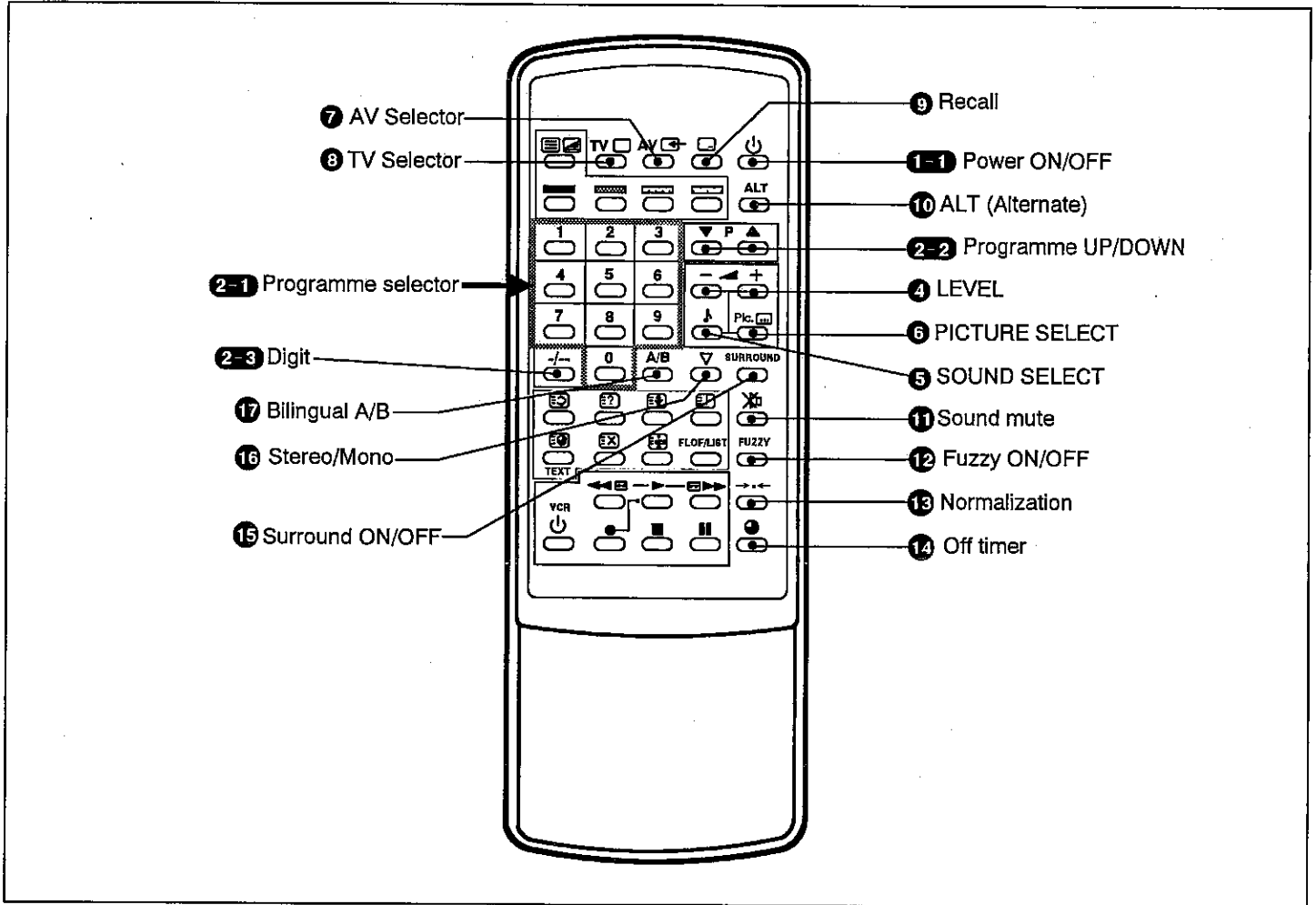

Main ON/OFF switch of the TV set must be in "ON" position before remote control operation is possible. Point transmitter towards the TV set, then press the appropriate function button for the following controls.

SWITCHING ON/OFF

1-1 Power ON/OFF

Press this button to turn on the TV set.
To turn off the TV set, press this button again.

PROGRAMME SELECTION

e.g. To select programme 17, press Digit **2-3** button and "1" then "7" button of the Programme selector **2-1**.

2-2 Programme UP/DOWN

To scan the programmes, press Programme UP/DOWN **2-2** button.

■ You can select programme number "1" to "9" and VCR position (0 key of the Programme selector **2-1**) directly from the standby mode.

e.g. To directly select programme "2" from the standby mode, press the "2" button. The set is then switched on, and the picture of programme 2 appears.

SOUND VOLUME ADJUSTMENT

To adjust the sound volume, press + or - LEVEL **4** button.

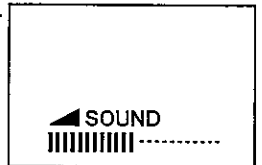

AUDIO ADJUSTMENTS

1 Press SOUND SELECT **5** button to select a sound control function.

Each time SOUND SELECT button is pressed, the control function changes as follows.

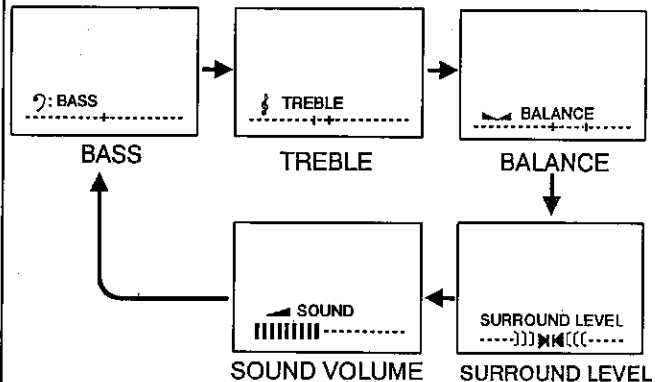

Note:
"SURROUND LEVEL" will be skipped when the surround effect is turned off.

2 Press LEVEL (+ or -) **4** button to adjust each control levels.

Teletext Use

■ Sub-coded page access

For Teletext information which is longer than one page it may take some time for the automatic changing of sub pages to reach the sub page you require. It is possible, however, to enter the sub-page you require and then continue watching the normal television picture until the correct sub-page is reached.

- Select the required page using the page selection button.
- Press the TIME/SUB button. The character "S" and sub code digits "****" will be displayed in the top left of the screen.
- Enter the desired sub-page number before figure "S****" disappears. For example, if you select sub-page 10, you must press 0, 0, 1 and 0 button. Then the character "+" is displayed following the page number.
- Press the CANCEL to return to normal television programme. When the correct sub-page is reached the page number will appear on the normal television picture.
- Press the MIX/TEXT button to display the stored page.
- To clear the sub-coded page you must enter a new page number.

Note: It is not possible to select another television station during a sub-page access operation.

VIEWING TV WHILE SEARCHING FOR A PAGE

In some cases it can take some time to look for a page. In the interval you can view TV by pressing the CANCEL button. When the page arrives, the page number will appear on the normal TV picture. Press MIX/TEXT button to display the page.

Note: When you press the CANCEL button, the green ">" mark is displayed at the top right of the screen. Whilst this ">" mark is displayed you can not select another TV channel.

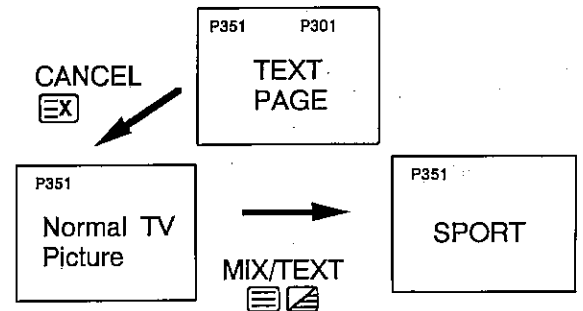

■ HOLD

If the teletext information is longer than one page, the pages are automatically changed. The automatic page changing can be cancelled by pressing the HOLD button. The word "HOLD" then appears on the top of the screen. Normal operation is restored by pressing the HOLD button again or entering a page number.

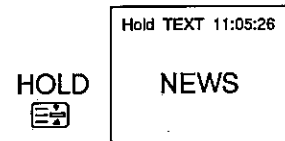

■ DOUBLE LETTER HEIGHT

Either the top or bottom half of the display can be expanded by pressing the SIZE button. When the SIZE button is pressed for the first time, the top half of the display is expanded. If it is pressed once again, the bottom half of the display is expanded. To return the display to normal-sized characters, this button should be pressed a third time.

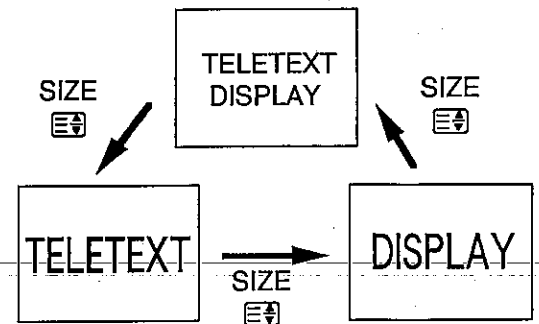

■ DISPLAYING CONCEALED INFORMATION

In one of the lists of contents you may find the heading "QUIZ" (concealed information). If you have selected the relevant page number questions will appear on the screen. You can find out the correct answer to the questions by pressing the REVEAL button. Press the REVEAL button again to make the answers disappear.

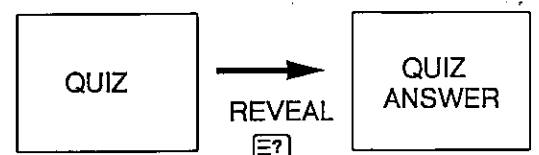

Teletext Use

■ ALARM CLOCK

The Alarm Clock Function can be set to operate at any requested time reminding viewers to carry out a specific task, i.e. making a phone call at a specified time.

First select either page 196 (BBC1) ※ or page 296 (BBC2) ※, using the page selection buttons. Press the TIME/SUB button, S**** will appear on the top of the screen. Select the time at which you require the alarm call. Example, for a call at 8.15 pm, press buttons 2015, watching that S**** changes to S20:15. Then press the CANCEL button to continue watching normal TV programmes. At 8:15 pm the words "ALARM CLOCK" in large letters will appear on the screen. Press the MIX/TEXT button to return to normal teletext operation. It is not possible to select another TV programme when in the CANCEL mode. (※ : Broadcast stations differ by country)

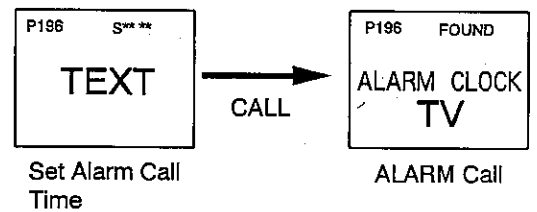

■ NEWS FLASH

If you select the news flash page and view the TV programme by pressing the CANCEL button, the moment news comes in, the word "NEWS FLASH" and the news appears over the normal TV picture. If you want to make the news disappear press the CANCEL button again. To recall the news, press the MIX/TEXT button.

Note : It is not possible to select another TV station during a NEWS FLASH. You should first switch back to TV reception by pressing the TV Selector(TV□) button. You can, however, change both the picture and sound settings.

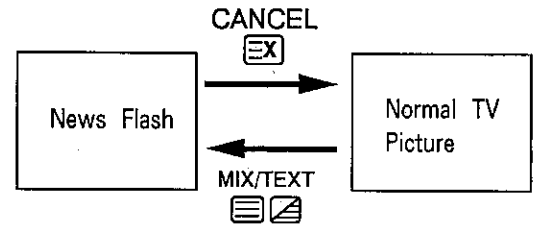

■ UPDATED PAGES

There are pages which are updated as events progress, such as sports results, news reports and traffic information. If you have selected one of the above pages from the list of contents and you want to view television but still be kept informed about the other events, press the CANCEL button. The page will disappear and the TV station which will broadcast this will appear in the screen. As soon as this page is updated, the page number will appear on the normal TV picture. To display the updated page on the screen, press the MIX/TEXT button. The page will disappear when the CANCEL button is pressed again.

Note : It is not possible to select another TV station during an UP- DATE. You should first switch back to TV reception by pressing the TV Selector(TV□) button. You can, however, change both the picture and sound settings.

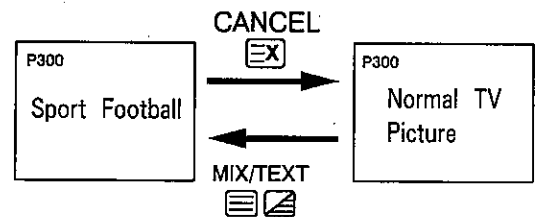

■ TIME

If the time is required while a programme is being viewed, press the TIME/SUB button.

Providing that the channel being viewed is also transmitting teletext, the time will appear at the top righthand of the screen for five seconds. The digits displayed represent hours/minutes/seconds.

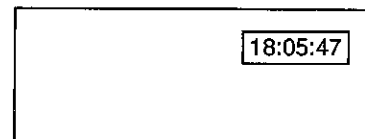

Remote Control Operation

VCR USE

This remote control transmitter has been designed especially to be used in conjunction with selected SANYO VCR's. Some SANYO VCR's may have their own functions, so please refer to the individual instruction booklet when using this remote control with SANYO VCR's to ensure compatibility.

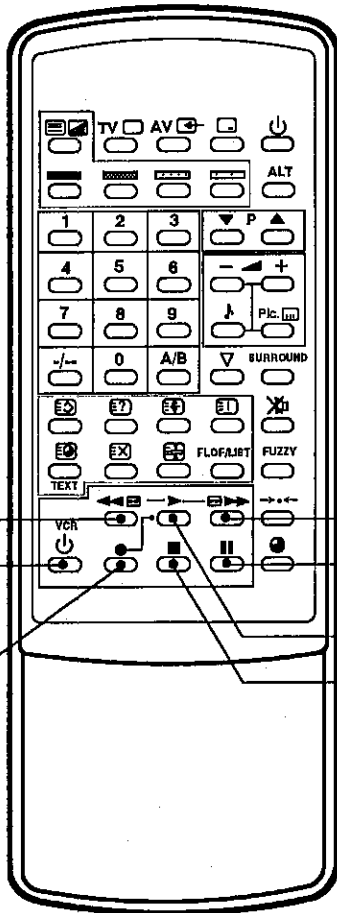

BATTERY INSTALLATION (REMOTE CONTROL TRANSMITTER)

- 1 Remove the battery cover by sliding.
- 2 Install two "AA" 1.5 volt batteries so that the "+" and "-" marks on the batteries match the "+" and "-" marks inside the unit.
- 3 Close the battery cover.

NOTE: Replace the batteries when the TV set is showing the following symptoms:

Operation is unsteady or erratic, sometimes the TV set does not work with transmitter. Discharged batteries may leak and damage the unit.

The normal life of batteries should be from nine to ten months.

REWIND/
REVIEW
POWER
ON/OFF
RECORD

FAST/CUE
PAUSE/
STILL
PLAY
STOP

POWER ON/OFF BUTTON

Use to turn VCR power on and off.

PLAY BUTTON

Use to playback the tape.

STOP BUTTON

Use to stop the movement of the tape.

FAST/CUE

Use to advance the tape at fast speed, or in order to playback the tape at fast speed.

REWIND/REVIEW

Use to rewind the tape, or in order to playback the tape in reverse at fast speed.

PAUSE/STILL

Use to temporarily stop (Pause) the tape when recording, or in order to see a still image during playback.

RECORD

Use to record on the tape.
Press and hold down RECORD button, then press PLAY button.

Pre-Setting of Stations

Up to 60 broadcast stations in your reception area can be stored in the electronic memory.

There are two ways of presetting as follows:

Automatic presetting - the basic way

All receivable channels are automatically tuned in and memorized in consecutive programme positions.

Manual presetting

Manually preset a channel if it cannot be automatically preset, such as when the signal is poor.

Automatic presetting

1. Press PRESET **18** button.

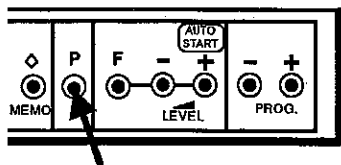

On screen display during presetting

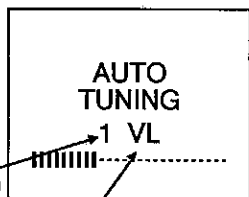

Programme position

Channel band
VL: VHF low band
VH: VHF high band
U: UHF band

2. Press LEVEL **4** (+) button.

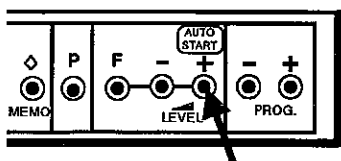

4. Press BAND selector **19** to select the channel band.

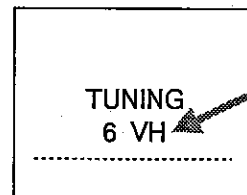
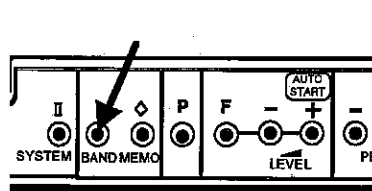

When BAND selector is pressed, the frequency will be set to the lowest frequency in the set band.

5. Press and hold LEVEL **4** (+/-) button until the desired station appears.

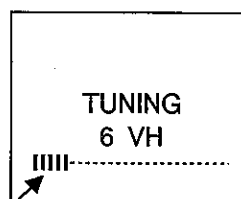
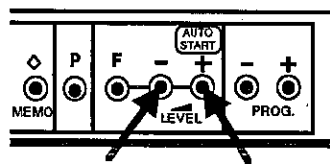

The number of upright segments increases for a higher frequency channel.

The channels are preset in consecutive positions beginning from the programme position "1".

After all available channels have been preset, the unit returns to the position "1".

Note: To cancel automatic presetting midway, press the PRESET **18** button.

6. Press MEMORY **20** button.

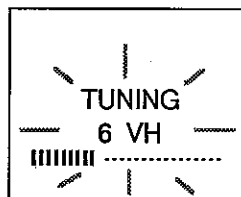
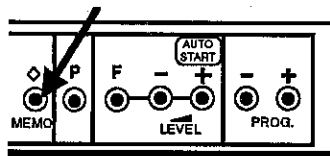

Manual presetting

1. Select the desired programme position by pressing Programme selector **2** or **2-1**.

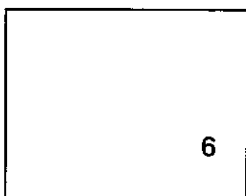
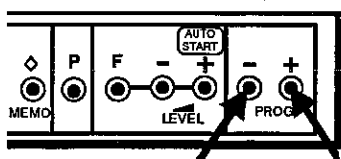

2. Press PRESET **18** button.

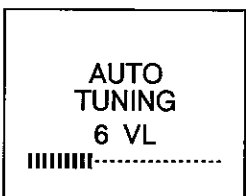
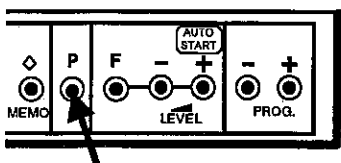

3. Press PRESET **18** button again.

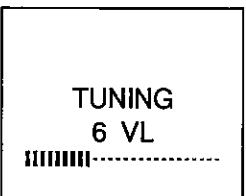
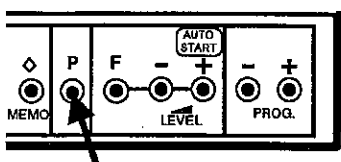

7. Press PRESET **18** button. This completes the presetting.

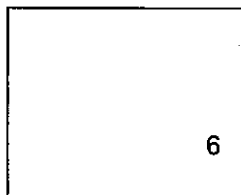
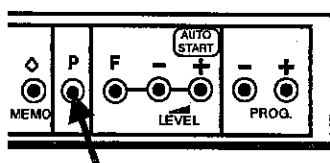

Repeat steps 1 to 7 for other desired channels.

Memory Copy

This TV tuning system has another advanced feature called "Memory Copy".

For example, if you wish to copy the TV channel in the programme position "2" into the programme position "6":

1. Select the programme position "2",
2. Press PRESET button **18**.
3. Press PRESET button **18** once again.
4. Select the programme position "6" by pressing programme selector **2** of the TV set.

Programme position

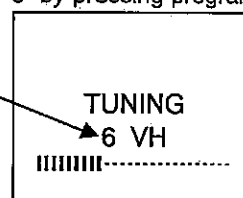

5. Press Memory button **20**.
6. Press PRESET button **18**.

Inserting Channels and Deleting Channels

Inserting Channels

The following example shows how to insert Channel-D of programme position "4" into programme position "2".

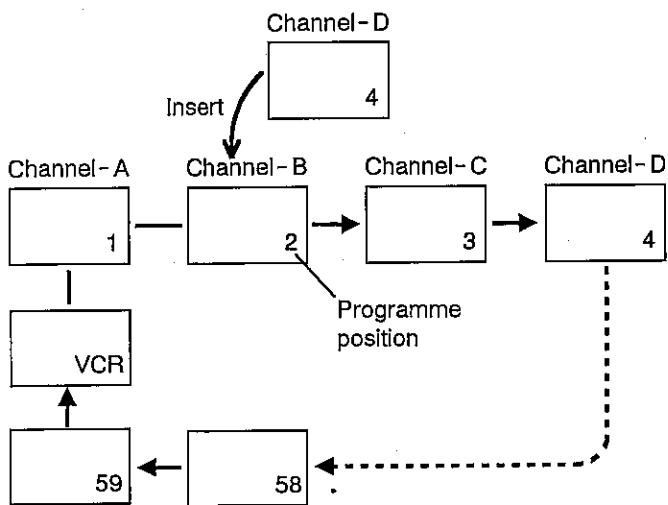

1. Select programme position "4" (Channel-D).
2. Press PRESET button **18**.
3. Press PRESET button **18** once again.
4. Select programme position "2" by pressing Programme Selector **2** of the TV set.

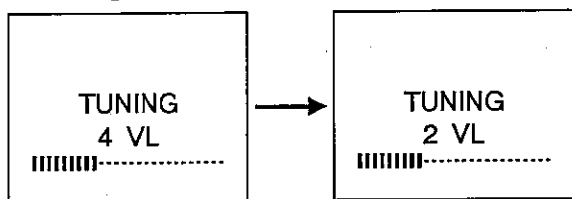

5. Press and hold down FUNCTION SELECT button **3**, then press the (+) Programme Selector **2**.
6. Press PRESET **18** button.

Channel-D of programme position "4" is now inserted into programme position "2". In this example, the channels from Channel-B (programme position "2") onward will be shifted successively into the next highest programme position.

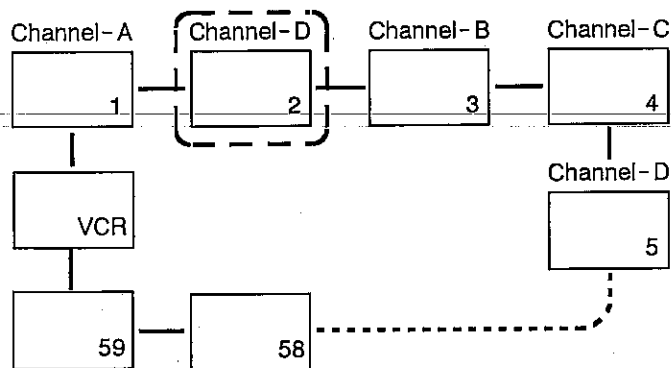

Note: You cannot insert a channel which would cause the channel in programme position "59" to shift to a higher programme position. You also cannot insert channels into the VCR position. When the above procedure is done, the position indicators will flash in red.

Deleting Channels

The following example shows how to delete Channel-B from programme position "2".

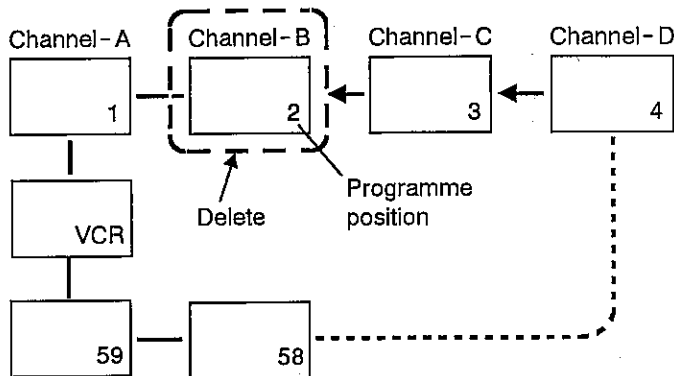

1. Select programme position "2" (Channel-B).
2. Press PRESET button **18**.
3. Press PRESET button **18** once again.

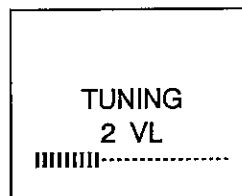

4. Press and hold down FUNCTION SELECT button **3**, then press the (-) Programme Selector **2**.
5. Press PRESET **18** button.

Channel-B of programme position "2" is now deleted. In this example, the channels from Channel-B (programme position "2") onward will be shifted successively into the next lowest programme position.

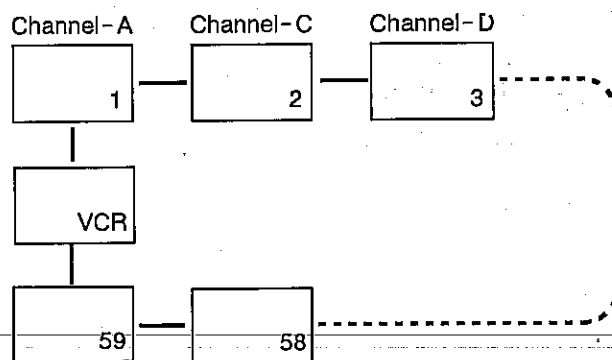

Note: Channel deletion is not possible in the VCR position. When the above procedure is done, the position indicator (VCR) will flash in red.

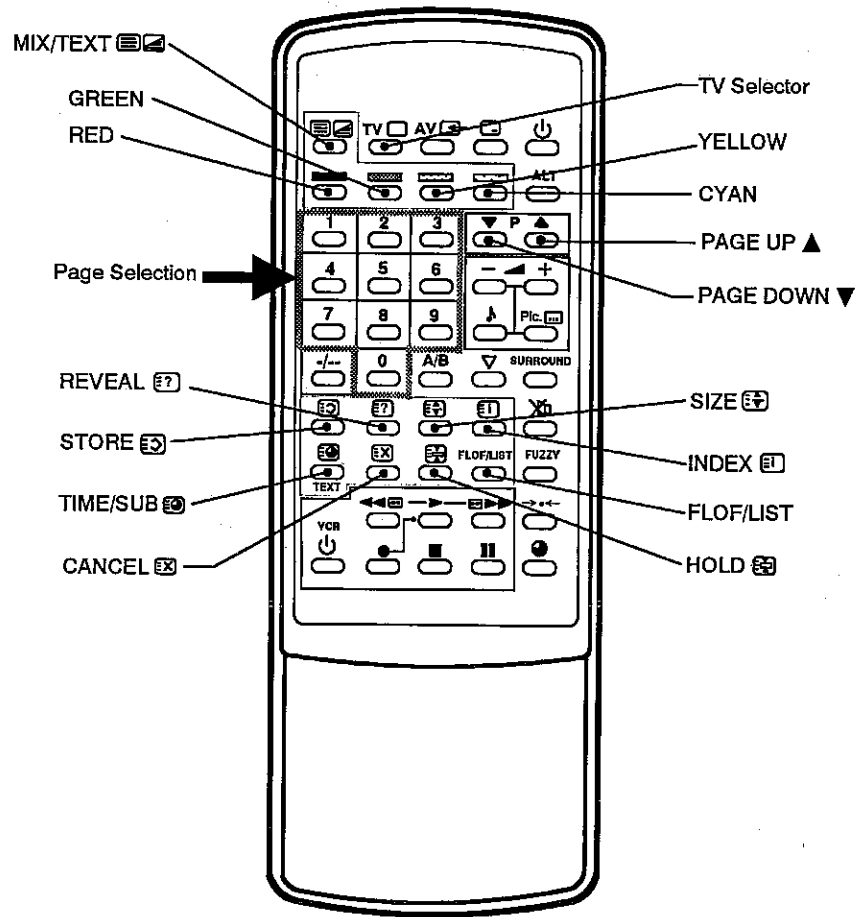

Switching to the Teletext mode

Press the MIX/TEXT button, and the screen changes as follows:

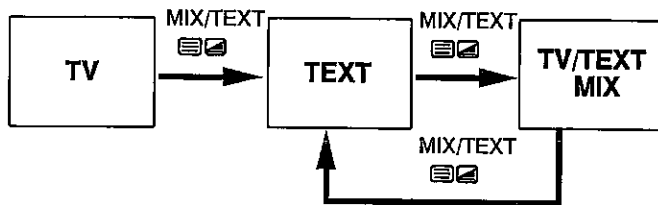

Switching to the TV mode

To return to the TV mode, press the TV button.

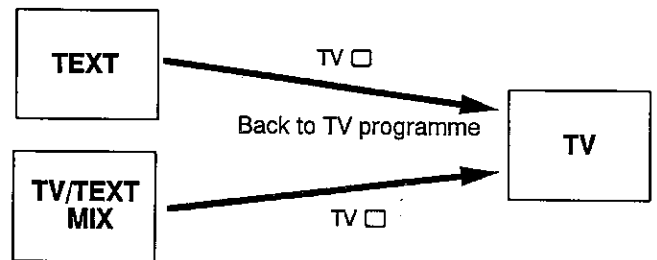

Page Selection

DIRECT PAGE ACCESS

A page can be selected with the 0- 9 buttons. For example, to display page 120 press buttons 1, 2 and 0. The selected page number will appear on the screen.

UP- DOWN PAGE ACCESS

If a page is displayed on the screen and you want to read the following page, you can press the UP button instead of selecting the page number. To bring back the previous page press the DOWN button. If you keep the UP or DOWN button pressed the page numbers will run up or down until you release the button.

The page number will change as follows by pressing the UP- DOWN button.

(▲)P200 - P201 - P202 -- P299 - P200 - P201

(▼)P200 - P299 - P298 -- P201 - P200 - P299

Note:In the FLOF/LIST mode, you can access the pages directly.

Remote Control Operation

PICTURE ADJUSTMENTS

1 Press PICTURE SELECT **6** button to select a picture control function.

Each time PICTURE SELECT button is pressed, the control function changes as follows.

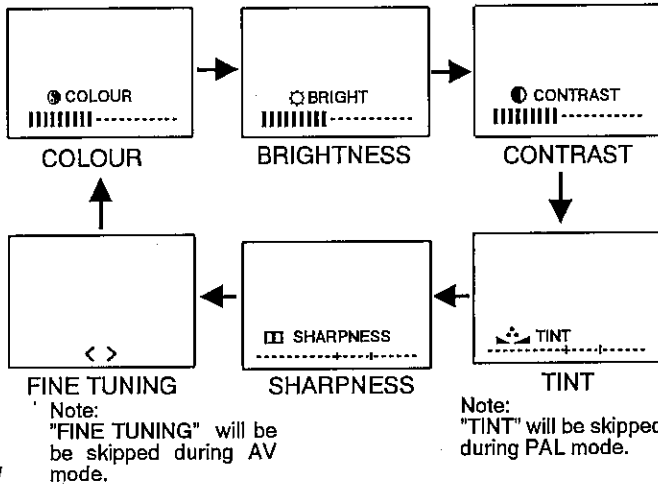

2 Press LEVEL (+ or -) **4** button to adjust each control levels.

Note:

Normally fine tuning is not required for this TV. However, in some case (such as radio interference) picture may become more clear by detuning from the best tuned frequency. In such case, you can use this fine tuning to eliminate some interference beat pattern.

12 Fuzzy ON/OFF

Press the Fuzzy ON/OFF button to set the viewing distance. Fuzzy logic uses both viewing distance and room brightness data to automatically set optimum picture quality for the image on the screen.

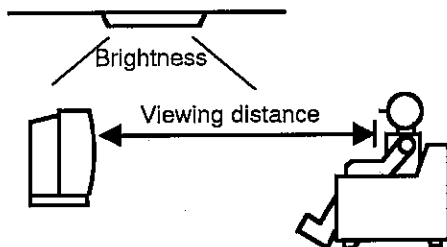

Each time the Fuzzy ON/OFF button is pressed, the viewing distance setting changes as shown below;

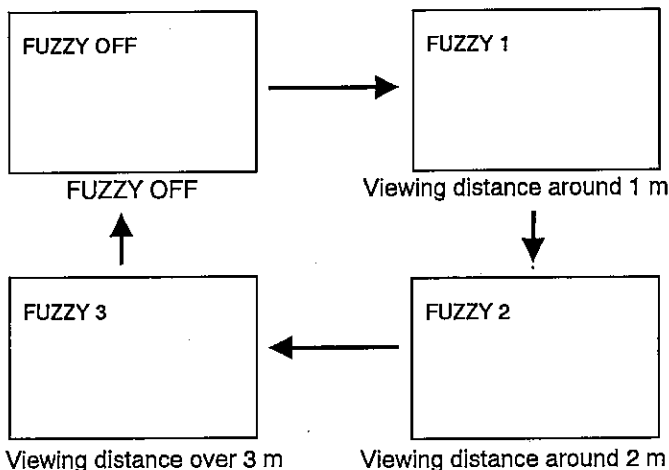

7 AV Selector

Each time the AV Selector **7** is pressed, the AV position changes as follows:

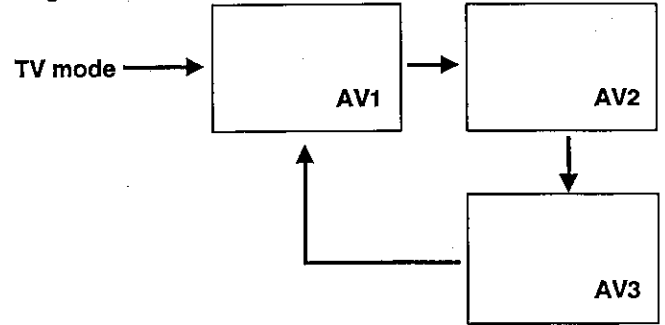

To return to the TV mode, press the TV Selector **8**.

9 Recall

To display the on-screen indications, press this button. The display disappears after five seconds.

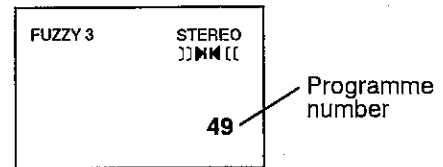

Note: When this button is pressed for more than 2 seconds, the following is displayed and the unit enters SELF DEMO mode. This mode is for use in storefront demonstrations. It has no effect on TV operation.

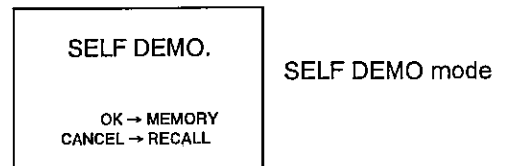

To cancel SELF DEMO mode, press the Recall button **9** once again.

If the Memory **20** button of the TV set is pressed in SELF DEMO mode, the self-demonstration will begin. You can also cancel SELF DEMO mode midway through play by pressing the Recall **9** button.

10 ALT (Alternate)

Press the ALT (Alternate) **10** button, and the programme position will alternately select the previous programme and the present programme. For example, now you are watching programme position "4" but you watched programme position "2" previously. If you press the ALT button, programme position "2" immediately appears.

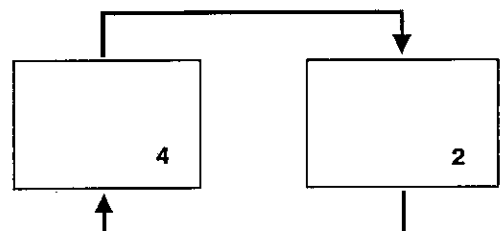

Remote Control Operation

11 Sound mute

Should you wish to mute the sound (e.g. While talking on the telephone), press this button once.

To switch the sound back on, press this button again.

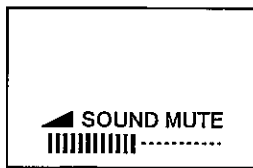

13Normalization

Press this button to recall the picture and sound settings which you stored using the Memory button **20** of the TV set.

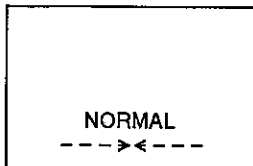

12Off timer

After a set time has elapsed, the power of the TV receiver is switched off automatically.

Each time off timer button **12** is pressed, the set time changes as follows:

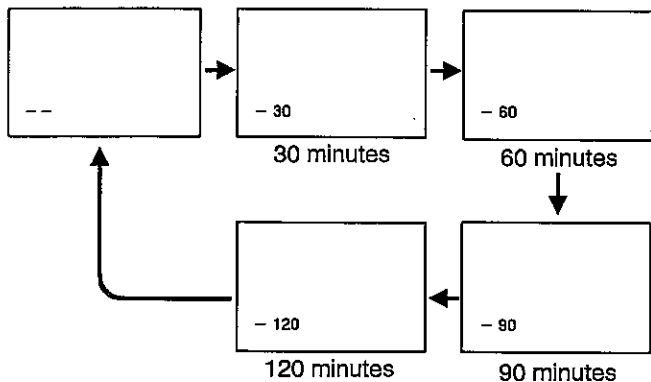

With the off timer being set and the channel display reset, the remaining time is displayed by pressing the off timer button again. When the button is pressed again within three seconds after the button was first pressed in above manner, the time is set to an upper time which is most close to the remaining time.

Just one minute before switching off, "- 01" and programme-number you are watching are displayed on the screen.

The timer setting will be cancelled if the power is switched off.

15Surround ON/OFF

To enjoy the surround effect, press the Surround ON/OFF **15** button.

To cancel the surround effect, press this button again.

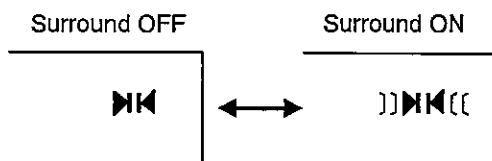

16 Stereo/Mono

When receiving the stereo broadcast, "STEREO" is displayed. If the sound of a stereo broadcast is not clear due to interference or poor reception, select the MONO position by pressing this button.

In the AV mode, select either STEREO or MONO to match the stereo or monaural condition of the audio signal coming from an external source, e.g. a VCR, AV equipment, or other component by pressing Stereo/Mono button.

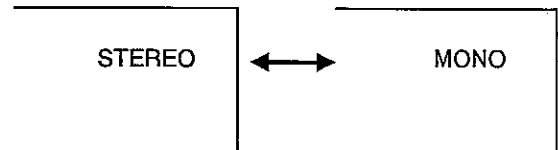

17 Bilingual A/B

When receiving the bilingual broadcast, MAIN(A) is displayed. You can select the main or sub language with this button.

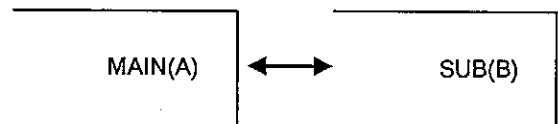

In the AV mode, each time Bilingual A/B button is pressed, the audio channel changes as follows:

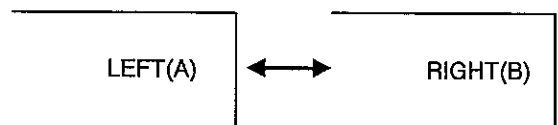

Teletext Use

■ FLOF AND LIST (FLOF: Full-level -one feature)

When a broadcasting station provides FLOF service, you can access the text pages you desire quickly and easily.

FLOF

In the text mode, FLOF mode can be selected by pressing FLOF/LIST button.

Then the index page which the broadcasting station provides, appears on the screen. At the bottom of the screen, red, green, yellow and cyan letters and "F" letters are indicated.

You can select a programme out of four programmes, by pressing one of the coloured buttons on the R/C transmitter. (For example, when pressing red, the red colour programme is selected)

In the same way, you can select the programme which is indicated at the bottom of the screen by pressing the colour button.

To get back to the initial index page, press the "INDX" button,

FLOF mode

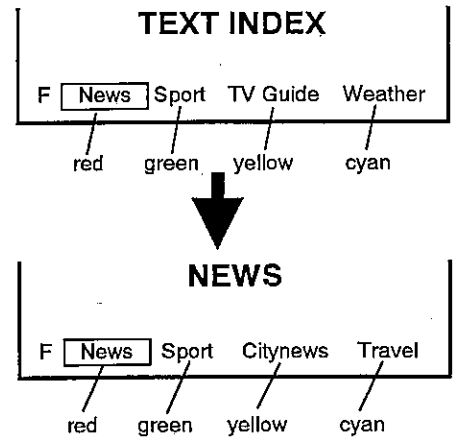

LIST

In the LIST mode, the four coloured page numbers and "L" letter are indicated on the bottom of the screen. The number on the left side is enclosed by a red frame. First, input the page number you desire, into each coloured position using the digit button, then press the "STORE" button for more than two seconds.

When the page number is memorized, the four coloured numbers change into white frame momentarily.

After you memorize the four page numbers, you can select the page you desire by pressing the red, green, yellow or cyan button. Even if you select another page by inputting a new page number, (See direct page selection), the memorized pages return after switching power off or changing the programme position or pressing the INDEX button.

LIST mode

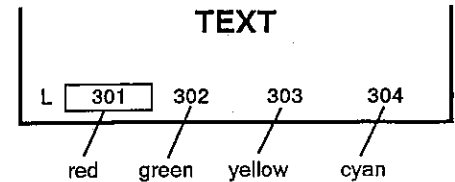

■ NON FLOF SERVICE

When the station does not have FLOF service, and you press the FLOF/LIST button, the INDEX page (P100) is automatically displayed.

At the bottom of the screen, the four page numbers 100, 199, 101, 102, are also displayed.

Then, when you select a random page number out of the displayed four pages by pressing a colour button, the text of that page is displayed.

The selected page minus one, plus one, and plus two page numbers are displayed but their display order is random.

Of course at any time you can select new pages by inputting new page numbers.

■ MEMORY OF THE TEXT PAGES

When you assign a broadcasting station which is providing a TEXT service to some programme positions of your TV set, four pages of TEXT can be memorized on each programme position.

(To memorize the TEXT pages, see "LIST mode".) If it is required to have more than four instant text available from the same text service, tune the necessary number of programme positions to the same TV channel.

- i.e. TV programme position 1.....page, 300, 301, 302, 303
- 2.....page, 304, 305, 306, 307
- 3.....page, 308, 309, 310, 311
-
- 16....page, 411, 412, 413, 414

The memory capacity is 16 programme positions and four pages per each position.

Note:

The producer and dealer does not take any responsibility for errors concerning teletext caused by wrong written teletext, wrong antenna installation or not sufficient power of transmitter (poor signal).

Connecting other Equipment

Video Multi Terminal

The AV input terminal of this TV set enables playback for VCRs and video disc players which employ the PAL, NAP(PAL-60Hz), NTSC and NTSC4.43 system

- Connect the video and audio outputs of a VCR, video disc player, etc. to the input jacks of this TV set. Tapes and discs can be played back.

- To watch the input picture, press AV Selector **7**.

Each time the AV Selector **7** is pressed, the AV position changes as follows:

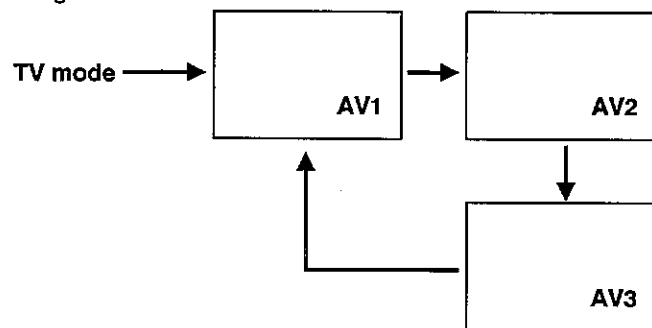

- If necessary, press Colour System selector **21** of the TV set to select the colour system to match the appropriate AV appliance.

In the AV mode, each time Colour System selector **21** is pressed, the colour system changes as follows:

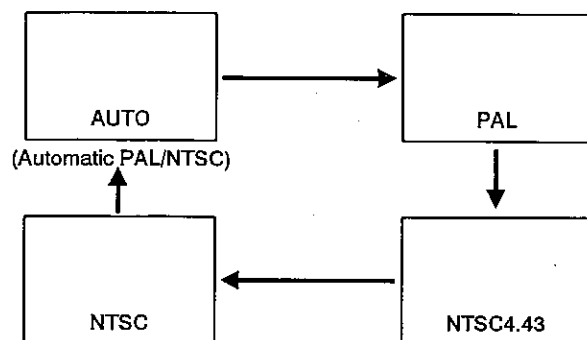

Note 1. When NAP system(PAL 60Hz) AV appliance is used, set the colour system to PAL position.

2. Colour System setting for each AV position are automatically stored in memory.

- See page 5 or page 7 for TINT adjustments on NTSC or NTSC4.43 systems.

- To return to the TV mode, press TV Selector **8**.

■ In the AV mode, you can select the TV programme.

If you wish to select the programme position "7" in the AV mode (while watching the playback from a VCR);

1. Select the programme position "7" by pressing the programme selector **2** or **2-1**.

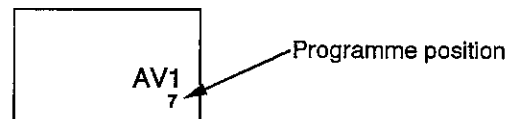

2. Press the TV selector **8** and the picture of the programme position "7" will appear.



Connecting other Equipment

■ Connecting to the AV1 Input Jacks

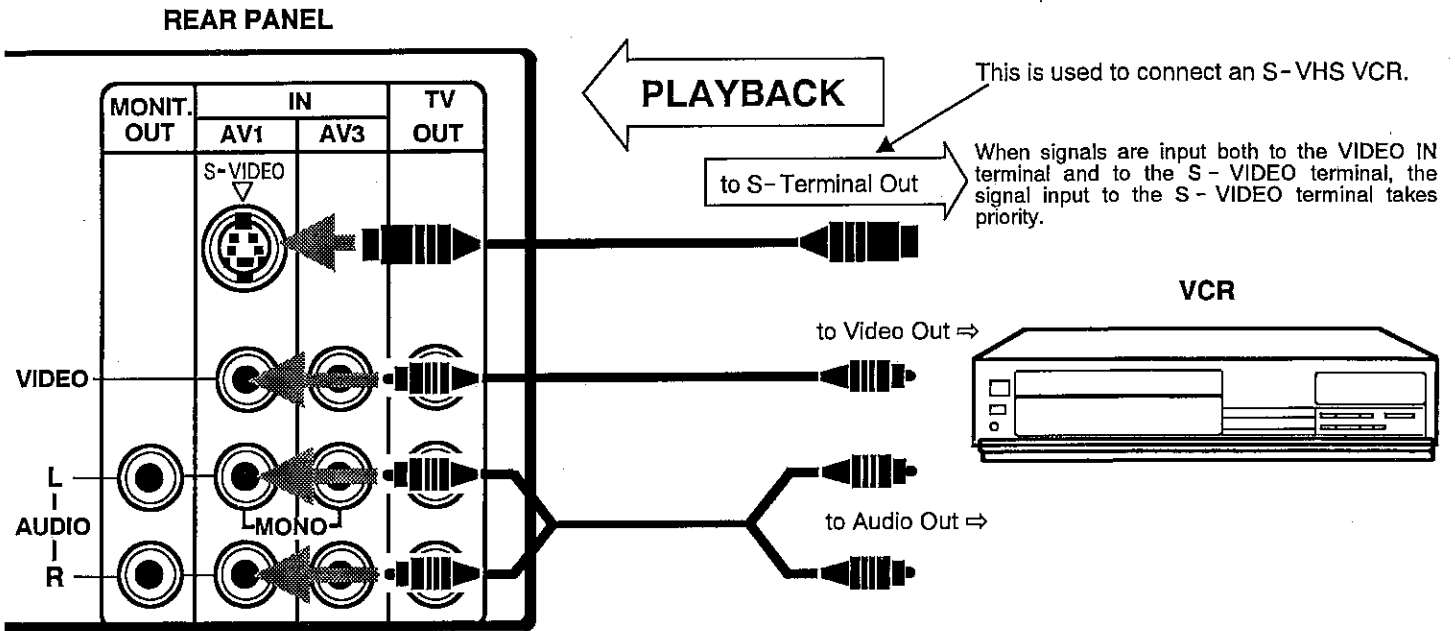

- Use the AV Selector **7** to switch to the AV1 position for watching.

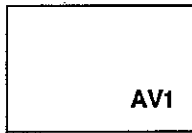

Video equipment can be connected in the same manner to the AV3 input jack. Select the AV3 position when equipment is connected to this jack.



- If the audio signal from the VCR is stereo, be sure to connect the right and left channels to the respective right and left Audio-in terminals. If the external audio signal is a monaural one, connect it to the left terminal of AUDIO IN. Then select the monaural mode of the audio channel in the TV set with the remote control Stereo/Mono button **16** or Bilingual A/B button **17**.
- **S-VHS VCR Connections.**
S-VHS VCR is designed with a highly advanced techniques. So the visual quality of S-VHS VCR is better than the other popular VHS VCR.
S-VHS VCR can be enjoyed by using S-terminal.

■ Connecting to the Front Panel AV2 Input Jacks

It is convenient to use the AV2 input jack on the front panel for equipment that is often connected and disconnected.

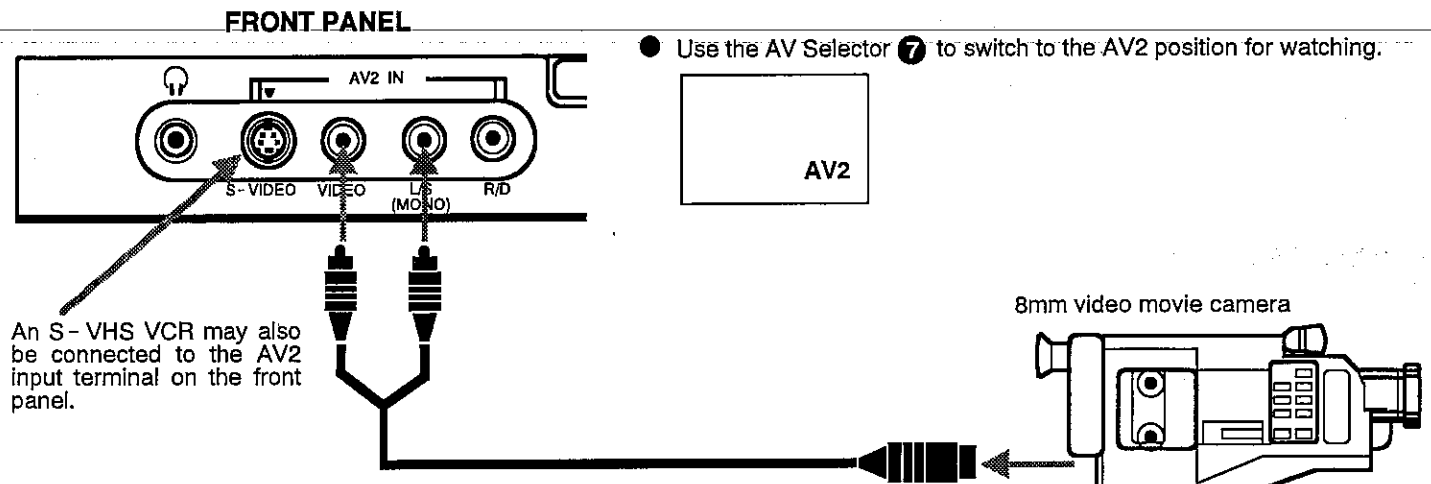

Connecting other Equipment

■ Connecting to the TV OUT Jacks

The TV OUT terminal provides audio and video outputs for TV broadcasts being received. They are used to record TV broadcasts.

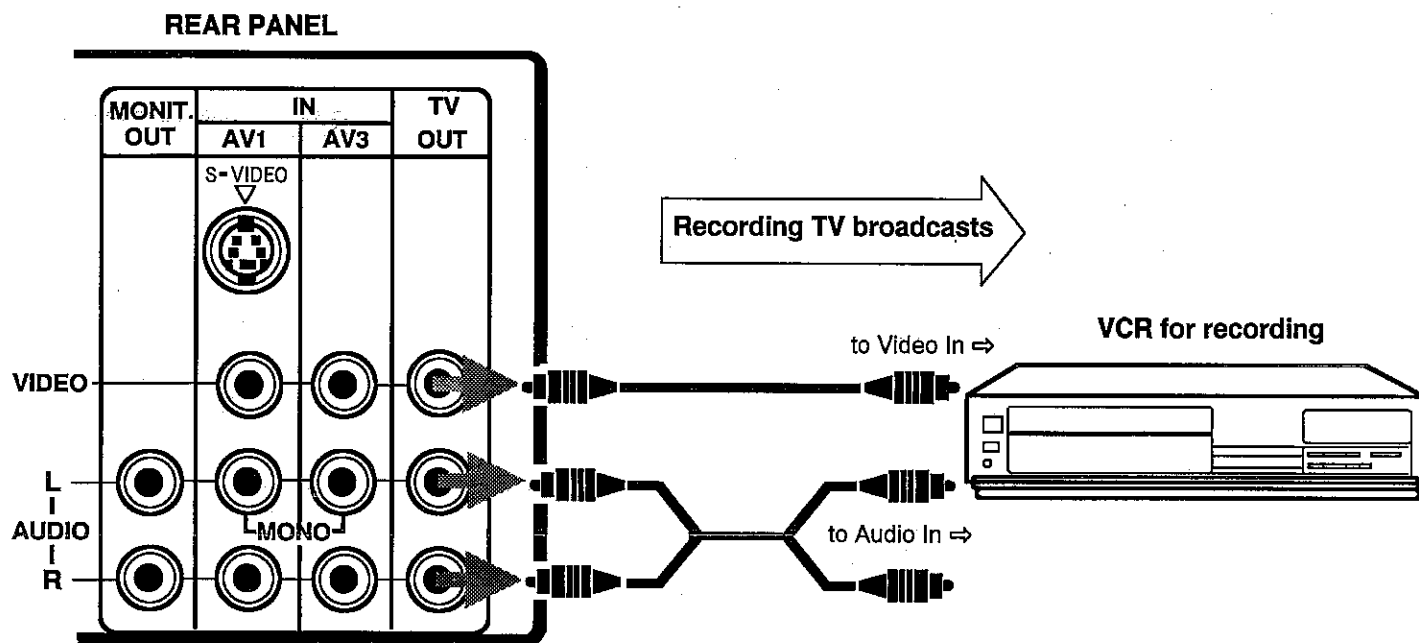

■ Audio Monitor Out Connection

More powerful sound can be enjoyed by using your audio apparatus.

Connect the audio signal source from audio-monitor out terminal to the LINE-IN or AUX terminal of the audio apparatus.

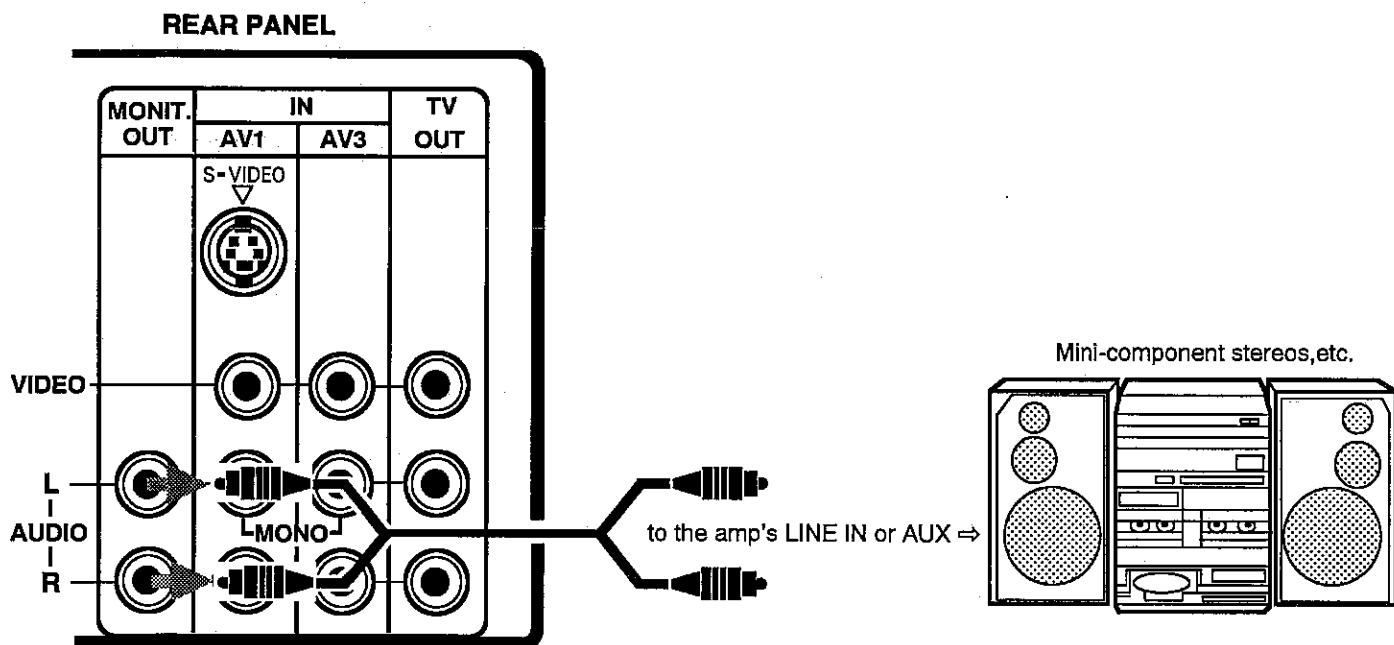

- Audio recording is also possible using this terminal.
- With this connection method you can enjoy surround sound using the speakers of your audio apparatus and the TV speakers.

Connecting other Equipment

External Speaker Connection

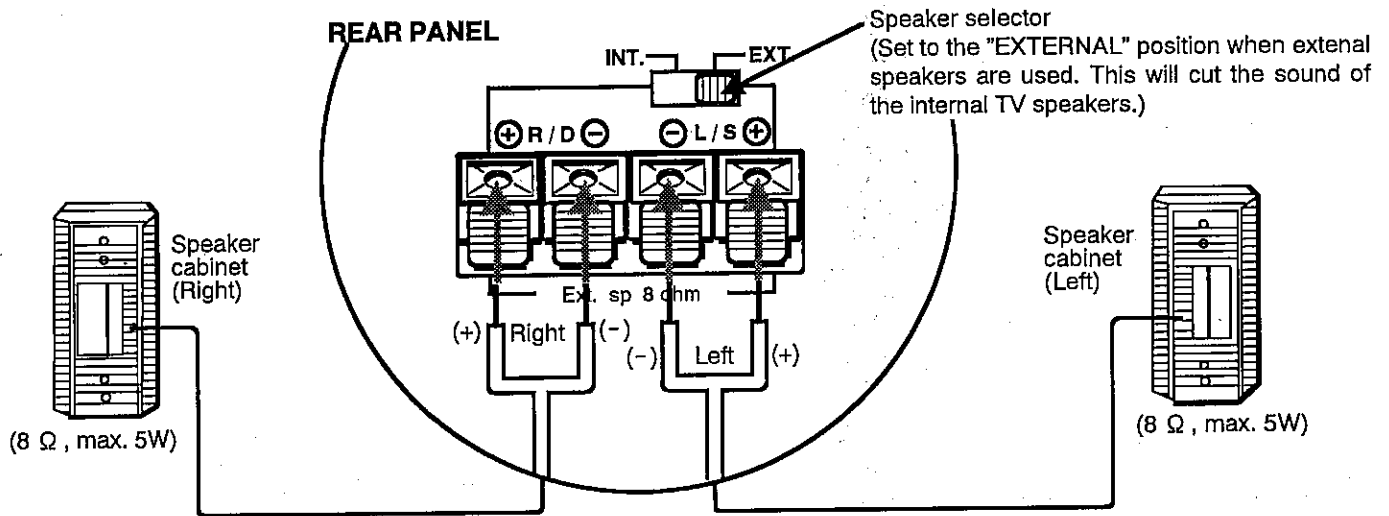

You can also enjoy Surround sound through connected external speaker.

AV Connection to the Aerial Socket

The AV apparatus can also be connected to the aerial socket of your TV receiver.

When AV equipment is connected to the aerial socket, set the VCR to the "VCR" position, the VCR position can be selected directly the "0" key on the remote control transmitter.

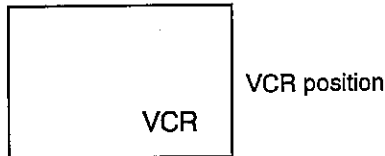

Note: In this connection, it can be used for AV apparatus which employs PAL system only.

• For further details concerning this connection and adjustment, refer to the operating instructions for the AV equipment.

Specifications

Power source	AC 220-240 Volts, 50Hz.
Television and Colour System	PAL-B/G : (AV input: PAL/NTSC/NTSC4.43)
Channel Coverage	Model CPP2530/ CPP2530TX/ CPP2930/ CPP2930TX VHF: 0-5, 5A, 6-11 UHF: 28-69 Model CZP2530/ CZP2530TXN/ CZP2930/ CZP2930TXN VHF: 1 - 11 UHF: 21 - 69 Model CAP2530N/ CAP2930TXN VHF: E2 - E12 UHF: 21 - 69
Aerial input impedance	75 Ω
Speackers	4 x (5cm x 9cm)
Audio output	15W
Ext. terminals	Video inputs: Phono jack x 3(1V p-p, 75 Ω) S-terminal x 2 (DIN 4 pin separate, Y/C signal input) Audio inputs: Phono jack (R/L) x 3 (436 mVrms, more than 40K Ω) Audio monitor outputs Phono jack (R/L) x 1 (436mVrms, less than 600 Ω) TV outputs (video and audio) Video output - Phono jack x 1 Audio output - Phono jack(R/L) x 2 External speaker terminals 8 Ω , output max. 5W Headphone jack Mini. stereo jack
Dimensions	25-inch 672(W) x 516(H) x 446(D)mm 29-inch 744(W) x 589(H) x 492(D)mm
Weight	25-inch approx. 28 Kg 29-inch approx. 41Kg

Made in Japan

Specifications subject to change without notice.



SANYO ELECTRIC Co., Ltd.