

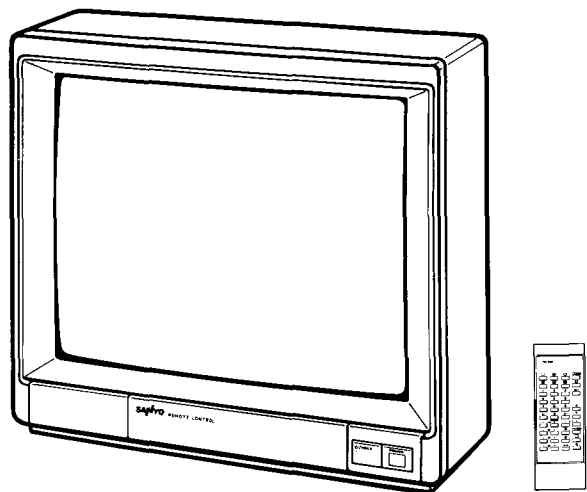

Instruction  
Manual

Colour  
Television

Model CZP 2135V



**TELETEXT\*** (OPTION)

NOTE: It is not equipped with the TELETEXT DECODER  
(OPTIONAL TELETEXT DECODER TYPE NO. TX-218)

### HELPFUL HINTS

#### NO PICTURE, NO SOUND

- Check if TV is plugged in.
- Try a different channel, if OK, probably station trouble.

#### POOR PICTURE, SOUND OK

- Adjust BRIGHTNESS control.
- Adjust FINE TUNING control.
- Check aerial connections.

#### NO COLOUR, PICTURE OK

- Adjust COLOUR control.
- Adjust FINE TUNING control.
- Is the program in colour?

#### WEAK PICTURE

- Check aerial connections on back of set.
- Check aerial for broken wires.
- Re-orient aerial.

The following faults are not caused by the receiver.

#### "GHOSTS"

Reflections of signals from mountains or high buildings will cause multiple images, called "Ghosts".

These abnormal conditions can be reduced to minimum by repositioning aerial or by installing new one suited for your area.

#### "INTERFERENCE"

Interference may be caused by electrical appliances, car ignition systems, etc. This should normally be a temporary condition, but should this interference persist, contact your dealer.

Slots and openings in the cabinet and in the back or bottom are provided for ventilation, and to ensure reliable operation of the television receiver and to protect it from overheating, these openings must not be blocked or covered.

#### AERIAL

The type of aerial required depends on factors such as the site, its distance and direction from the transmitter, local interference etc. Your dealer will advise you the best type of aerial to be used.

The aerial socket is on the back panel of the TV set.

#### MAINS SUPPLY

The receiver is designed to operate on an A.C. mains supply of 230 volts 50Hz.

#### SPECIFICATIONS

|                                  |                               |
|----------------------------------|-------------------------------|
| Power Source . . . . .           | AC 230V, 50Hz (AC 160 ~ 290V) |
| Television System . . . . .      | System B/G                    |
| Colour System . . . . .          | PAL                           |
| Channel Coverage . . . . .       | VHF: 1 - 10<br>UHF: 21 - 69   |
| Aerial Input Impedance . . . . . | 75 ohm                        |



## Controls

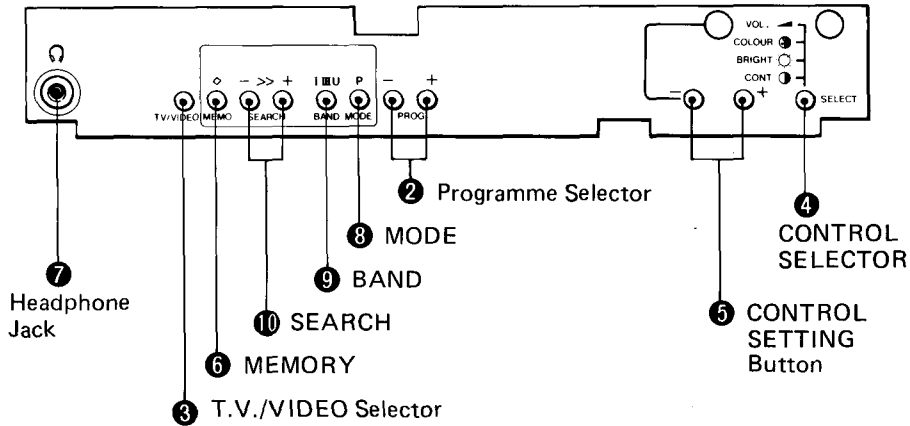
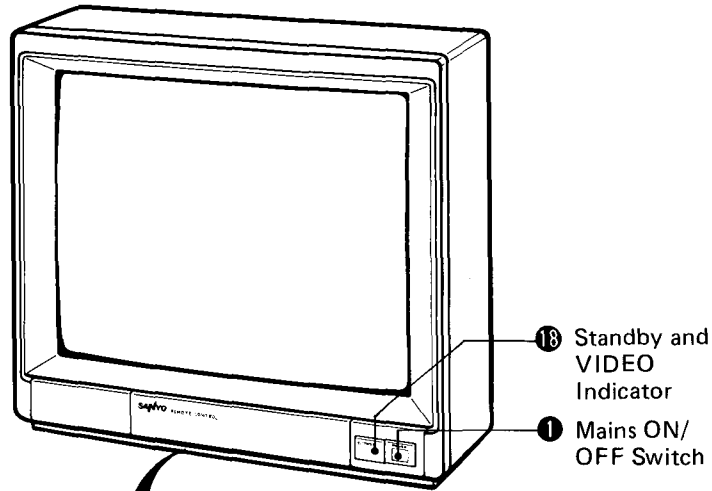

### ON-SCREEN DISPLAY: EXAMPLE

● **PROG. POSITION**  
Display time  
continues for 5 sec.

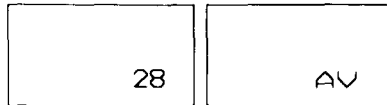

● **VIDEO MODE**  
Display time  
continues for 5 sec.

● **SOUND VOLUME**  
Display time  
continues for 5 sec.

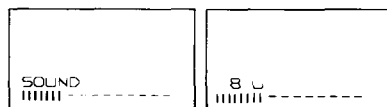

● **TUNING (Pre-Setting)**  
Display time  
continues during  
MODE switch ON.

## General Operation

### 1 .... Mains ON/OFF Switch

The set is switched on by pressing button 1. To switch off, press button again.

Note: To switch ON the TV set in the standby Mode:

Press the Power ON/OFF button  on the remote control transmitter, the CONTROL SETTING button 5 (on the TV set) or the Programme Selector 2 (on the TV set).

The TV set can not be turned on by pressing the Mains ON/OFF Switch 1 (on the TV set) in the standby mode.

### 2 .... Programme Selection

Press the right side (+) of the programme selector 2, and the TV set will step up to the next station, i.e; 1, 2, 3 . . . 29, VCR1, VCR2, VCR3, 1, 2, 3 . . . Press the left side (-), and the TV set will step down to the previous station. The position number is displayed on the screen.

### 3 .... T.V./VIDEO Selector Button

To watch television programmes leave this switch in the T.V. mode. When this switch is set to the VIDEO mode you can enjoy the playback from VCR or other AV equipment connected to the AV input terminals. "AV" is displayed on the screen. (The green VIDEO indicator 13 will illuminate.)

### CONTROL SETTING

1 Select the CONTROL FUNCTION (SOUND VOLUME, COLOUR, BRIGHTNESS or CONTRAST) by pressing the CONTROL SELECTOR 4 button.

\* Each time the CONTROL SELECTOR button 4 is pressed, the CONTROL FUNCTION changes as follows;

SOUND VOLUME → COLOUR → BRIGHTNESS → CONTRAST

\* "SOUND", "COLOUR", "BRIGHT" or "CONTRAST" is displayed on the screen.

2 Adjust the SOUND VOLUME, COLOUR, BRIGHTNESS or CONTRAST to the desired level by pressing the CONTROL SETTING 5 button.

### 6 .... MEMORY

Present SOUND VOLUME, COLOUR, BRIGHTNESS and CONTRAST levels can be set into the memory by pressing the MEMORY 6 button, and these control levels can be recalled by pressing the NORMALIZATION 13 key on the REMOTE CONTROL TRANSMITTER.

### 7 .... Headphone Jack

Inserting the headphone (option) to the outlet provides personal listening, (or recording purpose with the appropriate lead.) The TV set speaker is automatically switched off.

# Remote Control Operation

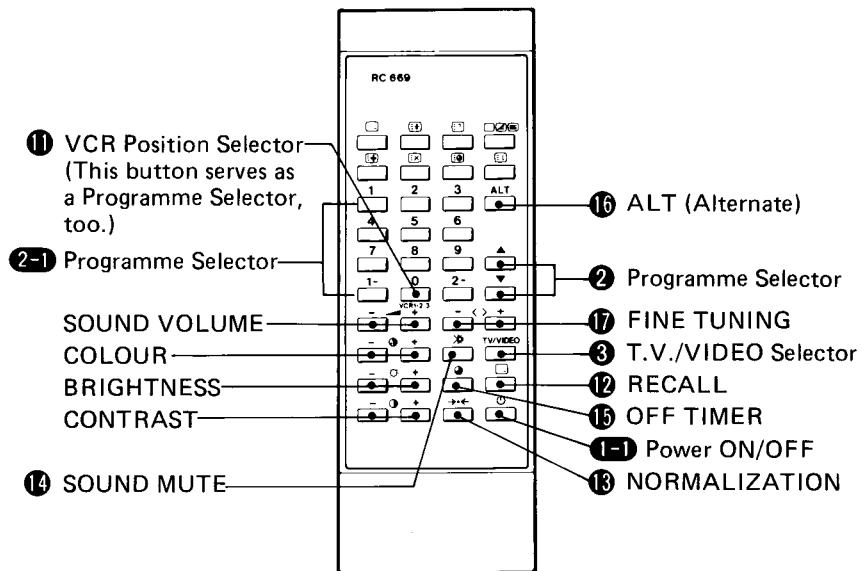

Main ON/OFF switch of the TV set must be in "ON" position before remote control operation is possible.

Point transmitter towards the TV set, then press the appropriate function button for the following controls.

- The keys on the Remote Control Transmitter operate in the same manner as those on the front of the television. In addition to those controls, the transmitter has these additional functions: Programme Selection (direct selection), NORMALIZATION, Sound Mute, OFF TIMER, Alternate, RECALL and FINE TUNING.

## 1-1 .... Power ON/OFF

Press this button to switch TV set on. To switch TV set off, press again.

Note: The red standby indicator **18** will remain illuminated when the TV set is switched off with this button. This is to indicate that the TV set is still partially energized.

To disconnect TV set completely from mains, switch off with Main ON/OFF switch on the T.V. set itself.

## 2-1 .... Programme selection

- For selection of the programme number 1 to 9, press the programme selector button **2-1**.
- For selection of the programme number 10 to 19 or 20 to 29, press the "1-" or "2-" button and then press the "0" to "9" programme selector button **2-1** within five seconds.

## 1 .... VCR Position Selector (This button serves as a Programme Selector, too.)

When using a VCR connected to the aerial socket, VCR Position must be selected by pressing this button.

- Each time the VCR Position Selector **1** is pressed, the VCR Position number will change as follows: VCR1 → VCR2 → VCR3
- The character of "VCR1", "VCR2" or "VCR3" is displayed on the screen.

## 12 .... RECALL

The POSITION in present selection and the remaining time in use of setting OFF timer are displayed on the screen by RECALL KEY.

## 18 .... NORMALIZATION →•←

When this button is pressed, automatically SOUND VOLUME, COLOUR, BRIGHTNESS and CONTRAST are set at the levels which had been memorized by the MEMORY **6** button.

## 14 .... Sound mute

Should you wish to mute the sound (e.g. While talking on the telephone) Press this button once. To switch the sound back on, press it again.

## 15 .... OFF TIMER

After a set time has elapsed, the power of the T.V. receiver is switched off automatically. Each time the key is pushed, the set time changes as follows:

Channel number display → 30 minutes → 60 minutes → 90 minutes → 120 minutes

With the off timer being set and the channel display reset, the remaining time is displayed by pushing the off timer key again. When the key is pushed again within three seconds after the key was first pushed in above manner, the time is set to an upper time which is most close to the remaining time.

- The timer setting will be cancelled if the power is switched OFF.

## 16 .... ALT (Alternate)

Press the "ALT (Alternate)" button **16** and the T.V. set will alternately select the previous channel and the present channel. For example, now you are watching channel 4 but you watched channel 2 previously. If you press the "ALT Key", channel 2 immediately appears then channel 4 is stored in the memory.

## 17 .... FINE TUNING < >

For tuning of the best picture and sound, press the (±) Fine Tuning button.

- The programme number is displayed on the screen when the FINE TUNING buttons are depressed. Display time continues while these buttons (±) are depressed and for 5 seconds after detaching them.

## ON-SCREEN DISPLAY: EXAMPLE

- OFF TIMER

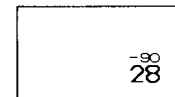

- NORMALIZATION

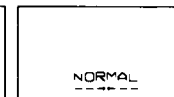

- SOUND MUTE

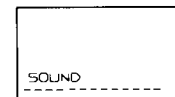

Display time continues for 5 sec.

## BATTERY INSTALLATION (REMOTE CONTROL TRANSMITTER)

- Remove the battery cover by sliding.
- Install two "AA" 1.5 volt batteries so that the "+" and "-" marks on the batteries match the "+" and "-" marks inside the unit.
- Close the battery cover.

### NOTE:

Replace the batteries when the T.V. set is showing the following symptoms: Operation is unsteady or erratic, sometimes the T.V. set does not work with transmitter. Discharged batteries may leak and damage the unit. The normal life of batteries should be from nine to ten months.

## Pre-Setting of Stations

Up to 32 broadcast stations in your reception area can be stored in the electronic memory.

- 1 Set the 8 MODE switch to ON position.
- 2 Select the programme number (with programme selector button 2 or 2-1) for which you would like to preset a program.  
Set the 9 BAND SWITCH to the channel band corresponding to your desired channel.  
Channel band VL, VH and U are for the following channel groups.

### VHF range

Band VL(I) Channels 1 – 3  
Band VH(III) Channels 4 – 10

### HF range

Band U Channels 21 – 69

The channel (VL, VH or U) Band is displayed on screen.

### REMARKS

When the band is set using the BAND SWITCH, the frequency will be set to the lowest frequency in the set band.

- 3 Press and hold the 10 (+) SEARCH button to station searching.  
When a station is found, release the (+) SEARCH button as soon as picture appears.

### REMARKS

The lowest bar display changes according to UP/DOWN of tuning voltage.

If the station found in above step is not the one to be set, press the (+) SEARCH BUTTON again until the desired station appears.

- 4 Once the best picture have been obtained, press the 6 MEMORY button to store the station located by the tuning in the electronic memory.

- 5 Repeat steps 2 – 4 for remaining program numbers to be set.

- 6 Be sure the 8 MODE switch is in OFF position.  
When the MODE switch is switched OFF, BAND SWITCH, the (+) and (–) SEARCH buttons will not function.

## Memory Copy

This T.V. tuning system has another advanced feature called "memory copy".

A station entered into the memory at a particular programme number can also be received at any other programme number, to use this feature follow the procedure below.

If you wish to copy the T.V. channel in the programme number "2" into the programme number "15".

1. Select the programme number "2". (with the prog. selector 2 or 2-1.)
2. Turn the MODE switch 8 ON.
3. Select the programme number "15". (with the prog. selector 2 or 2-1.)
4. Press the MEMORY button 6, set the MODE switch 8 to OFF.

## Video/Audio Input Connection

In order to watch the playback from a VCR, video disc player or the video signal from a video camera, the output terminal of the A.V. equipment in use must be connected to the VIDEO/AUDIO INPUT terminal. Note that the T.V./VIDEO switch must be set to the VIDEO mode to watch any A.V. program.

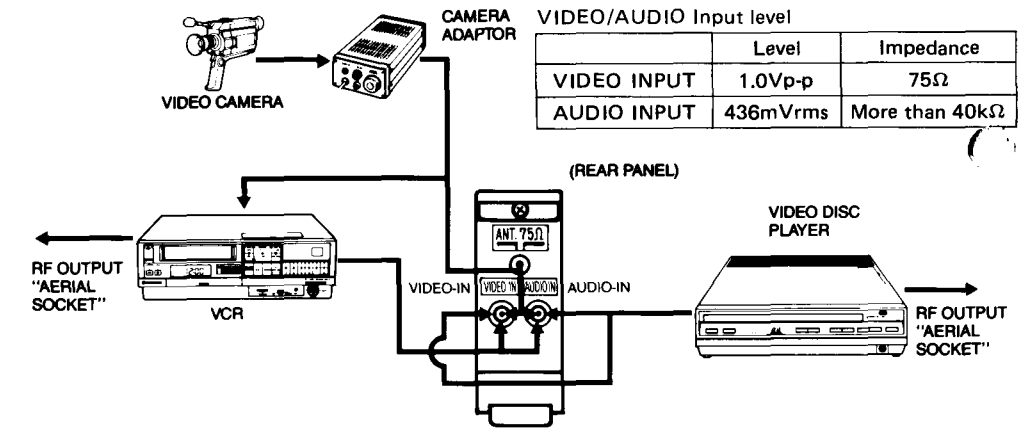

NOTE: In the VIDEO mode, you can select the T.V. programme.

- If you wish to select the programme number "7" in the VIDEO mode (while watching the playback from a VCR);

- 1 Select the programme number "7" by the Programme Selector button 2 or 2-1.

- 2 Press the T.V./VIDEO Selector 3, and the picture of the programme number "7" will appear.

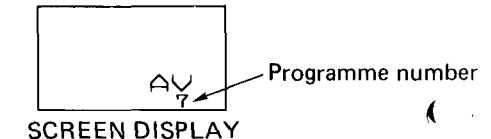

### A.V. (Audio Video) connection to the Aerial socket

The A.V. apparatus can also be connected to the aerial socket of your T.V. receiver. In this case, it is advisable to select the "VCR1", "VCR2" or "VCR3" position for the best picture by the VCR Position Selector 1.

VCR Position is specially designed for the VCR playback. The picture of the VCR playback may be distorted in other position.

For further details concerning this connection and adjustment, refer to the operating instructions for the A.V. apparatus.

## Teletext Mode \*

- The TELETEXT DECODER is an optional extra.  
(Optional TELETEXT DECODER TYPE NO. TX-218)

The teletext service are carried on the TV transmissions and therefore teletext will only be available when a TV programme (or test card) can be received on the screen. It presents in page form its own digest of news, views and a wide variety of other information, which is constantly being updated.

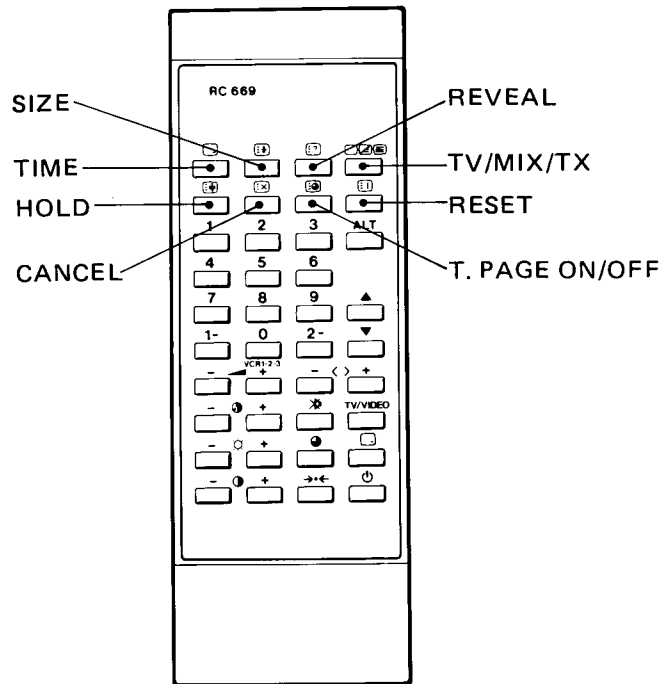

### Features

The TX-218 teletext decoder is a CCT (computer-controlled teletext) controlled by micro-computer, and has the following outstanding features.

- Very useful message, such as FOUND, HOLD, UPDATE, etc., are displayed in the upper part of the screen.
- Improvement of the character matrix, and an easier to read character display.
- Automatically adjust for displays in English, German, Swedish, French and Italian in accordance with the teletext broadcast signals.

## TV/MIX/TX

Television mode is always obtained with the receiver is first switched on. When this button is pressed, the receiver is switched to MIX mode. If this button is pressed once again, it is switched to TELETEXT mode. When this button is pressed in teletext mode, it is switched to operate as a normal television receiver.

### MIX

In normal teletext mode, picture video and character data are not displayed simultaneously. The MIX (superimpose) command restores the picture video so that the text is inlaid directly into the television picture.

### TEXT

When the "TV/MIX/TEXT" button is pressed to switch the system to the teletext mode, the page of the text is soon shown on the screen. The first line of each individual page is used for the requested page number, time-coded page number and status message. On the next line, the TV station, page counter, day, date and time are displayed.

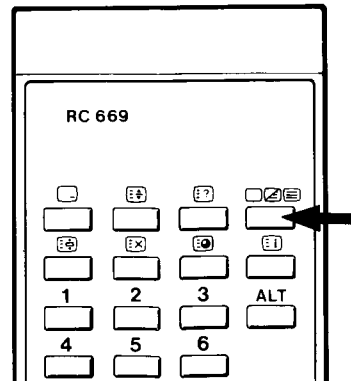

P100

CCT TELETEXT P100 Wed 16 Aug 18:46:05

## Page Selection (1, 2 . . . 9, 0)

When teletext mode is first selected, the index page (p. 100) is automatically obtained. The requested page is obtained by simply pressing three number buttons in sequence. For example, if you wish to look at page 151, pressing the number, (1), (5) and (1) in turn.

As each command is accepted, the page number at the left-hand end of the header will be built up, digit by digit, until it is complete.

After the final entry has been registered, rolling page numbers are presented until the requested page is received. As soon as the two groups of numbers coincide, the information contained on page 151 appears.

Other pages of the same service can be obtained in this manner, using the appropriate number.

It is not necessary to go back to the index page each time; within any one service you can change direct from one page to another. After a new page has been entered, the previous page is displayed until the new page is received. On reception of the new page, the rolling page number stops, showing the requested page number.

Note: If the new page is a NEWSFLASH or SUBTITLE page, the television video is automatically turned on, and the newsflash or subtitle is displayed in a box within the picture. Conversely, if the old page was a newsflash or subtitle page, and new page is not, then the picture is turned off.

If the television video is being displayed while the system is in teletext mode, and a new page is requested, then a box is generated around the page header for five seconds, so that the page number being entered can be seen.

P1

CCT TELETEXT P100 Wed 16 Aug 18:48:22

P15

CCT TELETEXT P100 Wed 16 Aug 18:48:24

## REVEAL

Some pages have part of the display concealed: a quiz page with concealed answers, for example. The command REVEAL displays the concealed text as long as REVEAL button remains depressed.

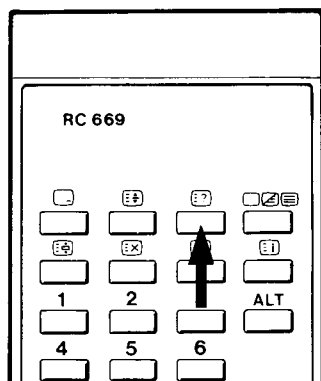

## CANCEL

The command CANCEL suppresses the text display and restores the television video while the system remains in teletext mode. The command TEXT or MIX restores the text display.

This facility allows the viewer to request teletext pages and alter teletext controls without interrupting a television programme. If a new page is requested, while the text is cancelled, the page header is displayed on the screen for five seconds. When the new page has been received, the new page number is displayed in a box on the screen.

This facility can also be used as an UPDATE control. For example, if P150 (Newsflash) is selected and then cancelled, as soon as the page is updated by the broadcasting authorities it will reappear on the screen. In the case of pages of normal text, when the page is updated the page number will appear in a box at the top left-hand corner of the screen.

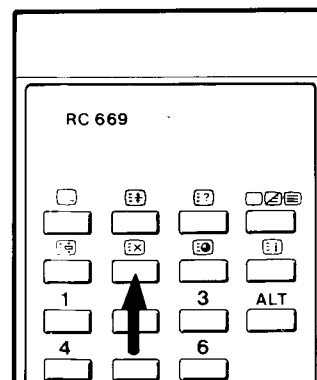

## Time Coded Pages (T.PAGE)

Time coding enables the viewer to put into store a specific page of information ready for viewing at a pre-determined time.

### IMPORTANT NOTE

With present transmissions this facility is limited to the 'Alarm Clock' pages. Please refer to the transmitted index for the appropriate page number.

The required page is selected in the usual manner and then the command T. PAGE (Time Page On) is entered. The time that the requested page should be received is then entered on the screen using the number keys two digits for hours and two digits for minutes, using the 24 hour clock system. The character 'T' precedes the time digits to indicate that a time code and not the actual code is being displayed, also the four digits flash. After the time code has been entered rolling page numbers are presented. The cancel button is then pressed and the receiver reverts to picture. When the pre-set time is reached the page number will appear in the top left corner of the screen and the data can be seen by pressing cancel again. To clear the time code from the T.V. memory, press T. PAGE button again. (Time Page Off).

It is important to remember that once the time coding has been set and the text cancelled pressing any buttons on the handset other than the Brightness, Colour, Volume and Mute may upset the pre-set time.

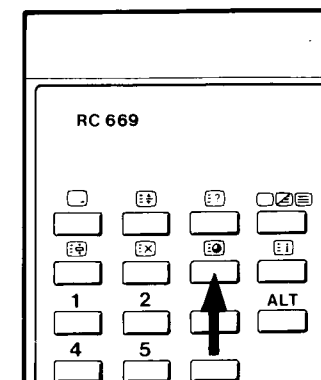

P160 T\*\*\*:  
CCT TELETEXT P160 Wed Aug 09:47:08

P160 T2\*:  
CCT TELETEXT P160 Wed 16 Aug 09:47:11

P160 T21:  
CCT TELETEXT P160 Wed 16 Aug 09:47:13

P160 T21:3\*  
CCT TELETEXT P160 Wed 16 Aug 09:47:16

P160 T21:35  
CCT TELETEXT P160 Wed 16 Aug 09:47:18

### RESET

When this button is pressed in teletext mode, several teletext functions are reset: the page memory is cleared, the command Time Page ON (T. PAGE) is cancelled, and the teletext decoder is set up to display the index page (P100).

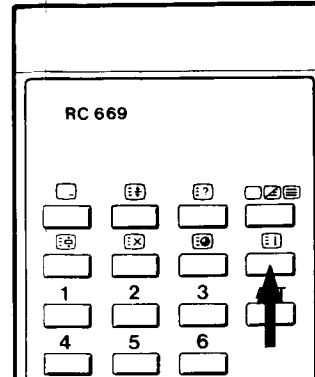

### TIME

If the time is required while a programme is being viewed press the button marked . Providing that the channel being viewed is also transmitting teletext, the time will appear at the top righthand of the screen for five seconds. The digits displayed represent hours/minutes/seconds.

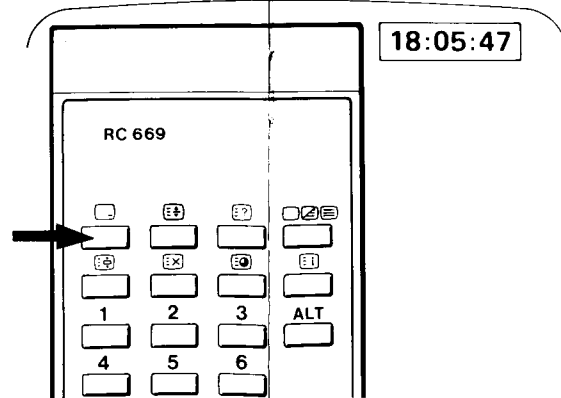

P151

CCT TELETEXT P144 Wed 16 Aug 18:48:27

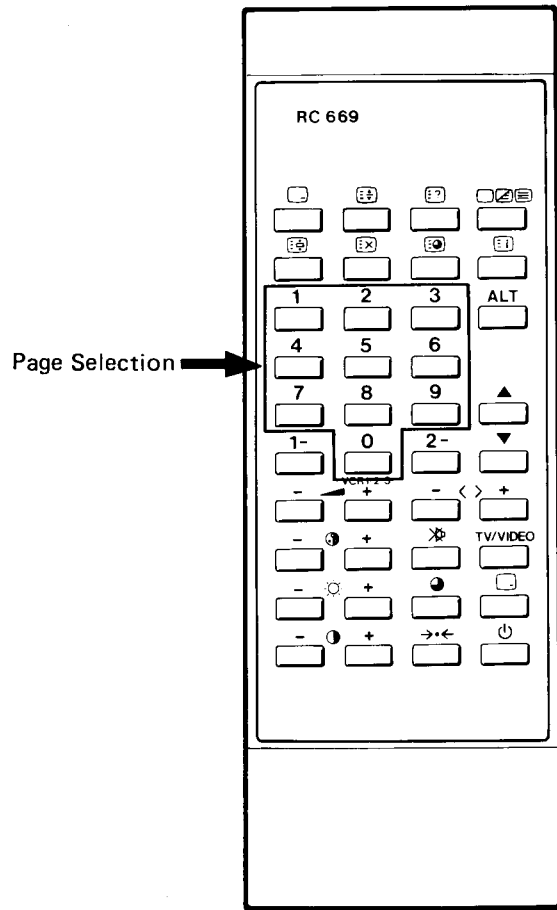

### HOLD

Some pages contain more information than can be displayed on the screen simultaneously and are therefore subdivided into a series of two or more sub-pages. The first sub-page of a series of four sub-pages, for example, has the indication 1/4 displayed at the top right of the screen (below the time).

These sub-pages are 'rotated', that is, each sub-page is displayed for a certain time (determined by the broadcasting authorities) before being replaced by the next sub-page. If it is desired to halt this rotation and retain a particular sub-page, the HOLD button should be pressed. The word STOP now appears on the centre of the status messages row.

This command stops the reception of teletext data and can be used to prevent the updating of pages whenever required.

Normal operation is restored by pressing the HOLD button again or entering a new page number.

P173

CCT TELETEXT P173 Wed 16 Aug 10:56:05

1/4

P173

STOP

CCT TELETEXT P173 Wed 16 Aug 10:56:06

1/4

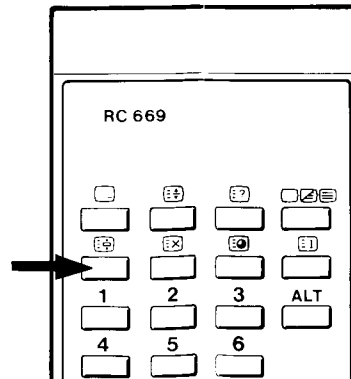

### Large Characters (SIZE)

Normally small characters are used in teletext mode, but in some circumstances the 'double-height' facility may be useful; when the viewer is some distance from the receiver, for example. Either the top or bottom half of the display can be expanded by pressing the SIZE button. When this button is pressed for the first time, the top half of the display is expanded. If it is pressed once again, the bottom half of the display is expanded.

To return the display to normal-sized characters, this button should be pressed again.

If television mode is selected while large characters are being displayed, small characters will be displayed when the system is next returned to teletext mode.

