

SANYO

**Instruction
Manual**

**Colour
Television**

Model CZP 2141 TX

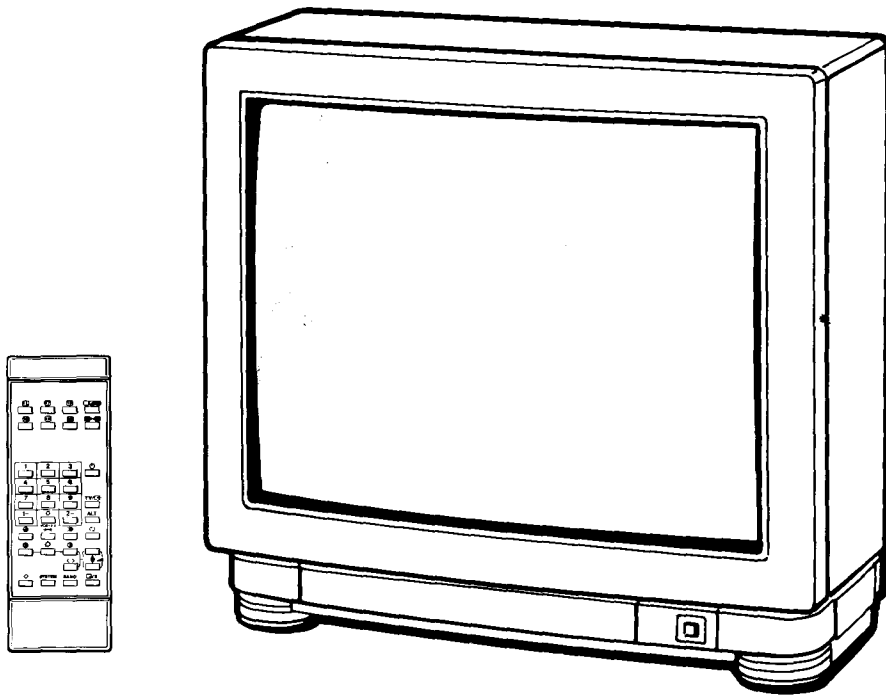

**TELETEXT
SPECIAL FUNCTIONS
CHANNEL SCANNING**

Electric Mains

The TV receiver is manufactured to utilize an AC Voltage Source of 230 Volts, 50Hz.

Safety Precaution

When the TV receiver is not to be used for an extended period of time, it is advisable to disconnect the AC power cord from the AC outlet.

WARNING

To prevent fire or shock hazard, do not expose the unit to rain or moisture.

High voltages are used in the operation of this TV set.

Do not remove the back from your set. Refer servicing to qualified service personnel.

Aerial Connection

- Connect the cable with a plug from a UHF (or VHF) aerial to the Υ aerial socket on the cabinet back.

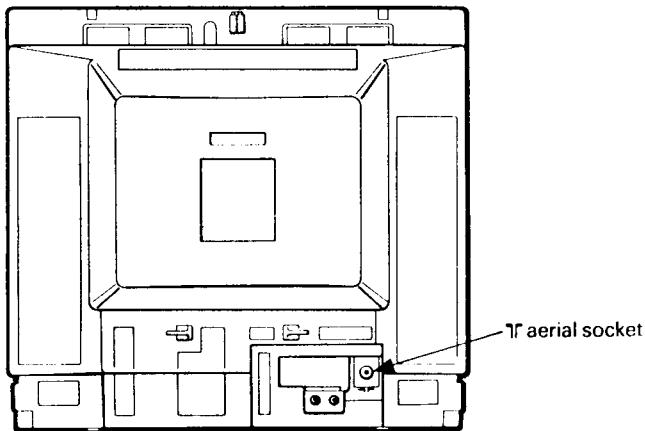

- For all aerial circuit problems please consult your local dealer.

Battery Installation (Remote Control Transmitter)

- 1 Remove the battery cover by sliding.
- 2 Install two "AA" 1.5 volt batteries so that the "+" and "-" marks on the batteries match the "+" and "-" marks inside the unit.
- 3 Close the battery cover.

Note: Replace the batteries when the TV set is showing the following symptoms:

Operation is unsteady or erratic, sometimes the TV set does not work with transmitter. Discharged batteries may leak and damage the unit. The normal life of batteries should be from nine to ten months.

Specifications

Power Source AC 230V, 50Hz.

Television System System B/G

Colour System PAL

Channel Coverage VHF : 1 — 11
UHF : 21 — 69

Aerial Input Impedance 75 ohm

Controls

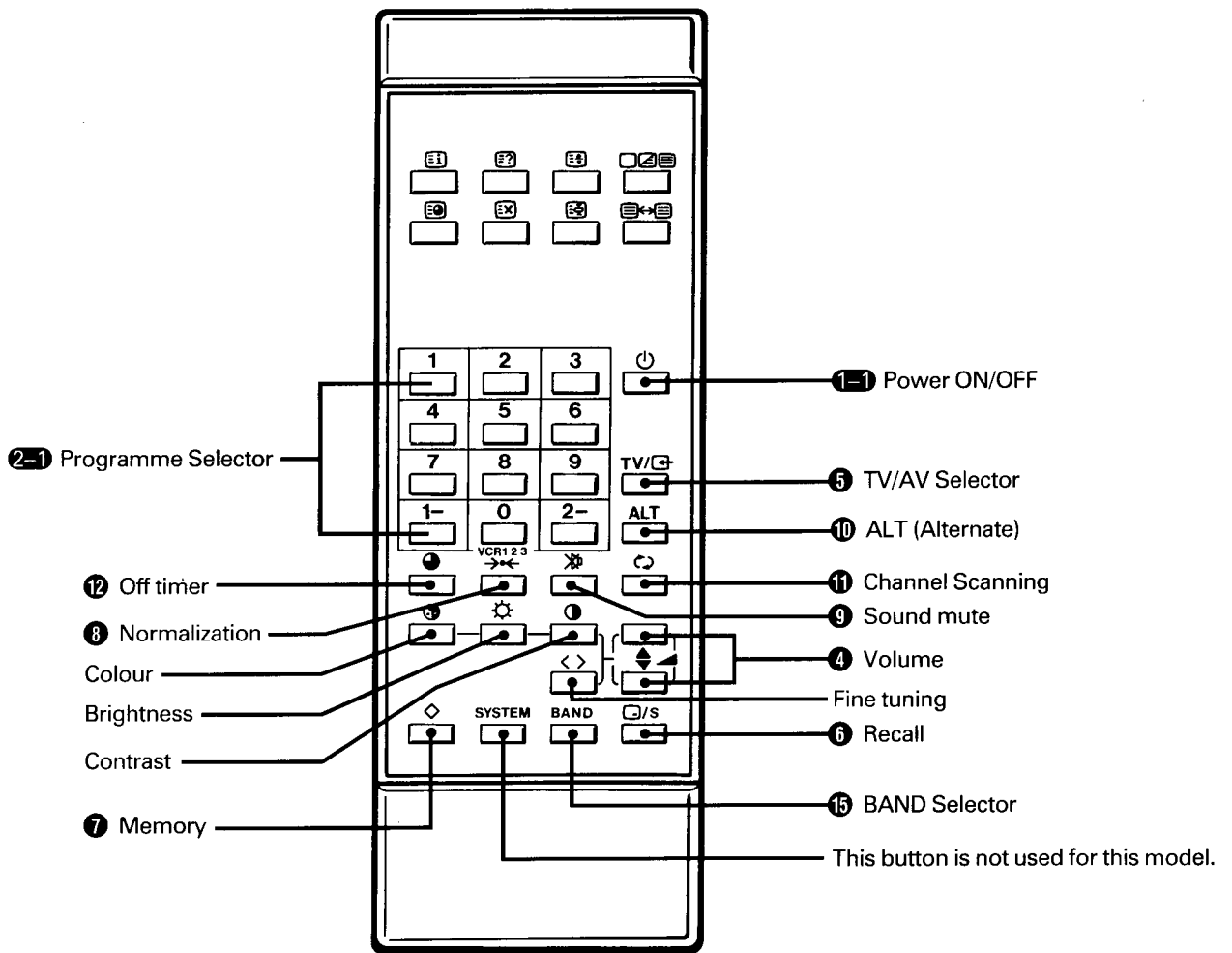
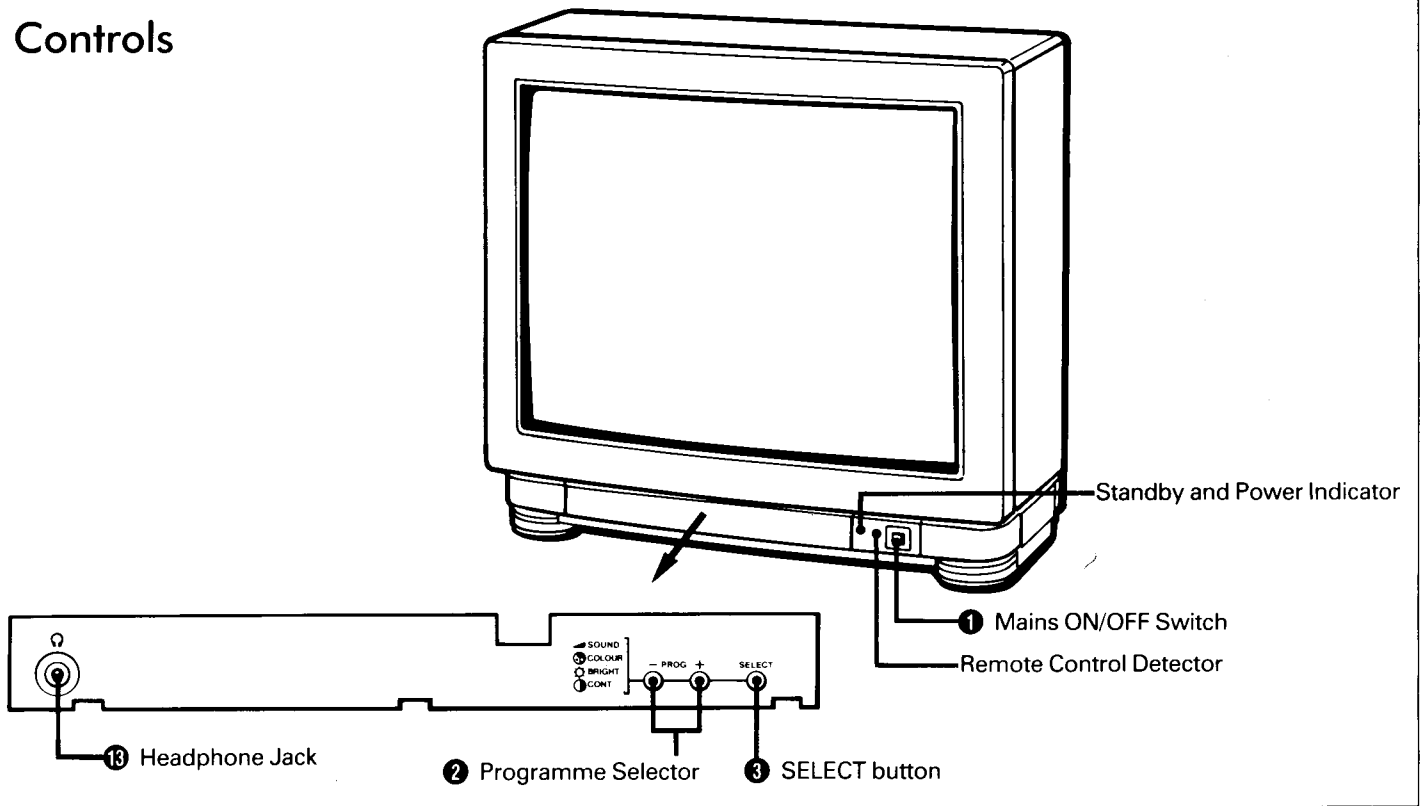

Remote Control Transmitter

General Operation

Usually the Remote Control Transmitter is all that is needed to watch the TV.

Please refer to the illustration on page 2, whilst reading these instructions.

Switching on/off

• To turn on the TV:

Press **Mains ON/OFF** switch ①.

• To turn off the TV:

Press the Power ON/OFF button ①-① on the remote control transmitter, and the TV changes to the standby mode. During the standby mode, the standby and power indicator illuminates more brightly than during the power-ON mode. Press this button to turn off the unit for short periods of the time.

• To turn on the TV from the standby mode:

Press one of these button.

- Power ON/OFF ①-①
- Programme Selector ②-① (except buttons "1-" and "2-")
- Programme Selector ②

• To cut off the mains power completely:

Press the **Mains ON/OFF** switch ①.

Important! Be sure to set the Mains ON/OFF switch ① to the off position, if the power failure occurs while viewing.

• AUTO SHUT OFF

This TV set incorporates the AUTO SHUT OFF function.

Even if the TV is left on after you have gone to sleep, the TV set changes to the standby mode within 10 minutes after all broadcasts have ended.

Note: AUTO SHUT OFF also functions for the AV mode even when there is no signal being transmitted.

The remaining time for AUTO SHUT OFF is displayed on the screen.

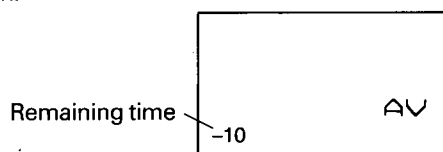

Programme selection

- e.g. To select programme number 17, press "1-" button and then press "7" button ②-① within five seconds.
To select programme number 27, press "2-" button and then press "7" button ②-① within five seconds.

• To scan the programmes:

Press the right side (+) of the programme selector ② of the TV set, and the TV set will step up to the next station, i.e; 1, 2, 3 ... 29, VCR1, VCR2, VCR3, 1, 2, 3 ...

Press the left side (-), and the TV set will step down to the previous station.

Picture and sound adjustments

(Use the remote control transmitter.)

• To adjust the sound volume:

Press ▲ (up) or ▼ (down) volume ④ button.

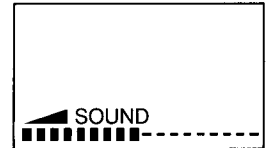

• To adjust the colour intensity:

Press ⊕ (Colour) button.

↓
Press ▲ or ▼ volume button.

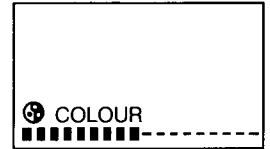

• To adjust the brightness:

Press ☀ (Brightness) button.

↓
Press ▲ or ▼ volume button.

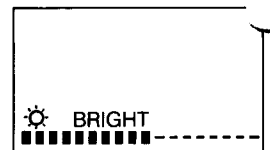

• To adjust the picture contrast:

Press ⊖ (Contrast) button.

↓
Press ▲ or ▼ volume button.

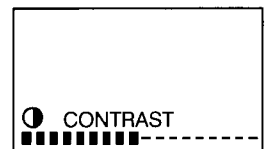

• Fine tuning

Press < > (Fine tuning) button.

↓
Press ▲ or ▼ volume button.

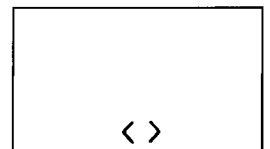

Note: Normally fine tuning is not required for this TV. However, in some case (such as radio interference) picture may become more clear by detuning from the best tuned frequency.

In such case, you can use this fine tuning to eliminate some interference beat pattern.

To adjust the picture and sound by using the front controls of the TV set:

① Select the control function by pressing SELECT button ③.

*Each time SELECT button ③ is pressed, the control function changes as follows;

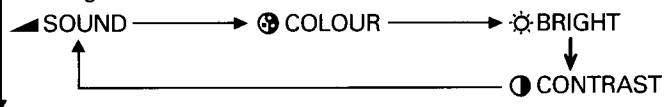

② Press Programme Selector ② (+ or -), and adjust the sound volume, colour, brightness or contrast.

(General Operation)

5 TV/AV Selector

To watch television programmes leave this switch in the TV mode. When this switch is set to the AV mode you can enjoy the playback from VCR or other AV equipment connected to the AV input terminals.

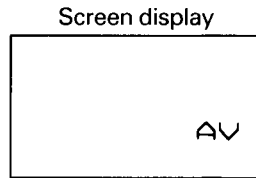

6 Recall /S

To display the on-screen indications, press this button.

The display disappears after five seconds.

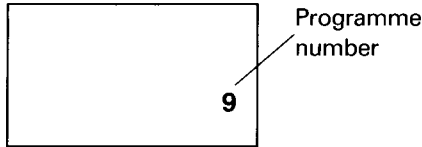

Note: When this button is pressed for more than 2 seconds, a menu display such as that shown at the right will appear. This menu display is used for presetting of stations and when setting special functions.

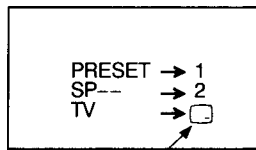

To return to the ordinary TV mode, press Recall button **6** once again.

7 Memory

Present sound volume, colour, brightness and contrast levels can be stored into the memory by pressing  (Memory) button twice, and these control levels can be recalled by pressing Normalization **8** button.

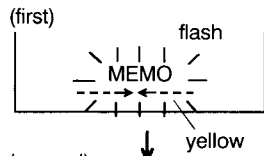

- Press MEMORY button once. The "MEMO" display flashes in yellow.

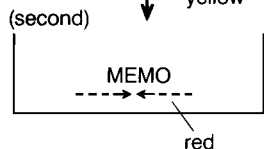

- Press MEMORY button again to complete memorizing. The "MEMO" display changes to red.

8 Normalization

When this button is pressed, sound volume, colour, brightness and contrast levels which are memorized by pressing Memory **7** button are recalled.

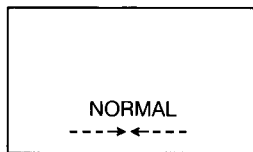

9 Sound mute

Should you wish to mute the sound (e.g. While talking on the telephone), press this button once. To switch the sound back on, press it again.



10 ALT (Alternate)

Press the "ALT (Alternate)" button **10** and the TV set will alternately select the previous channel and the present channel. For example, now you are watching channel 4 but you watched channel 2 previously. If you press the "ALT Key", channel 2 immediately appears.

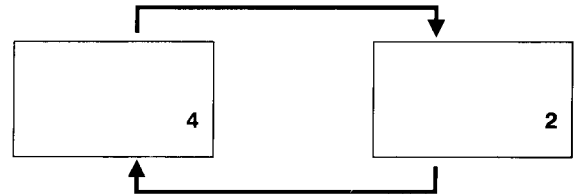

11 Channel Scanning

Press Channel Scanning button **11** to search for a programme. The channel positions are automatically scanned, and the channel scanning will stop at the position where it began. To stop at the position you want, press this button again.

12 Off timer

After a set time has elapsed, the power of the TV receiver is switched off automatically.

- Each time Off timer button **12** is pressed, the set time changes as follows:

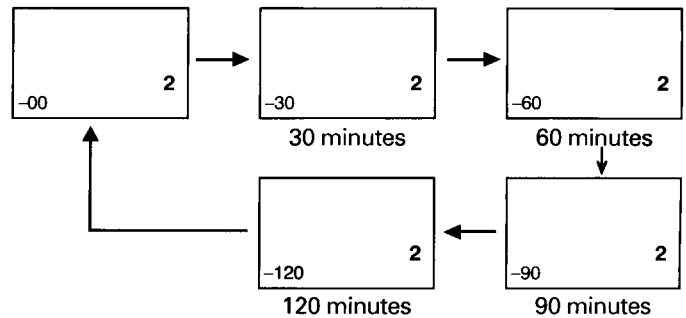

With the off timer being set and the channel display reset, the remaining time is displayed by pressing the off timer button again.

When the button is pressed again within three seconds after the button was first pressed in above manner, the time is set to an upper time which is most close to the remaining time.

- Just one minute before switching off, "-01" and programme number you are watching are displayed on the screen.
- The timer setting will be cancelled if the power is switched off.

13 Headphone Jack

Inserting the headphone (option) to the outlet provides personal listening, (or recording purpose with the appropriate lead.) The TV set speaker is automatically switched off.

Special Functions

- You can set the Special Functions to input the Special Codes.

The Special Codes and the Special Functions are as follows.

SPECIAL CODE	SPECIAL FUNCTIONS
00	Re-set all Special Functions (The start condition for the TV power is changed to the standby start.)
01	Re-set all Special Functions
70	Search for the Channel Scanning
71	Memory Delete for the Channel Scanning (Used to delete a programme position from the channel scanning positions.)
72	Memory Add for the Channel Scanning (Used to add a programme position to the channel scanning positions.)

NOTE: Special functions are not cancelled when the power is turned off or when the AC power plug is disconnected from the mains.

Search for the Channel Scanning (SPECIAL CODE "70")

- When SPECIAL CODE "70" is input, all the programme positions are automatically scanned, and the active programme positions are stored in memory. Once this programming is completed, the TV receiver will select only the stored programme positions when Channel Scanning key **11** is pressed.

To input Special Code "70":

- Press and hold **□/S** (Recall) button **6** of the remote control transmitter for more than 2 seconds.

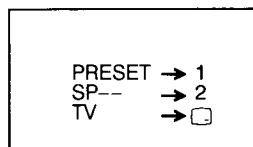

- Press "2" button of the programme selector **2-1**.

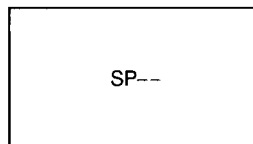

- Press "7" button, next press "0" button of the programme selector **2-1**.

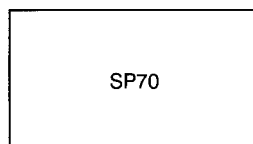

- Press **◇** (Memory) button **7**. The programme positions are then automatically scanned, and the active programme positions are stored in the memory.

The channel scanning will then stop at the position where it started scanning.

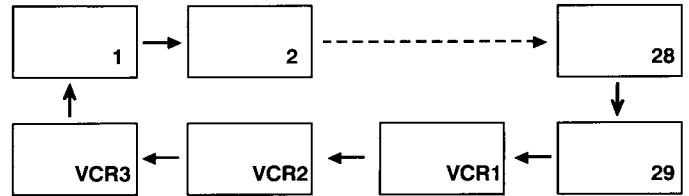

Search for the Channel Scanning is now completed.

Memory Delete for the Channel Scanning (SPECIAL CODE "71")

- This function is used to delete a programme position from the channel scanning positions, so it will not be scanned when Channel Scanning button **11** is pressed.

For example, to delete position "3" from the channel scanning positions:

- Select programme position "3" using the Programme Selector **2** or **2-1**.

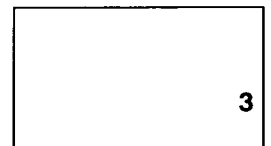

- Press and hold **□/S** (Recall) button **6** for more than 2 seconds.

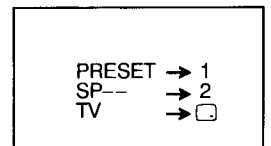

- Press "2" button of the programme selector **2-1**.

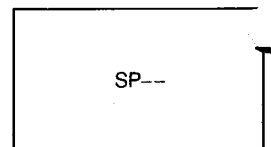

- Press "7" button, next press "1" button of the programme selector **2-1**.

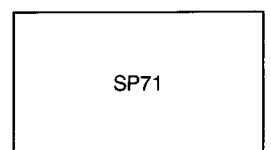

- Press **◇** (Memory) button **7**. ("SP 71" disappears.)

Position "3" is now deleted from the channel scanning positions.

Position "3" will be passed over when Channel Scanning button **11** is pressed.

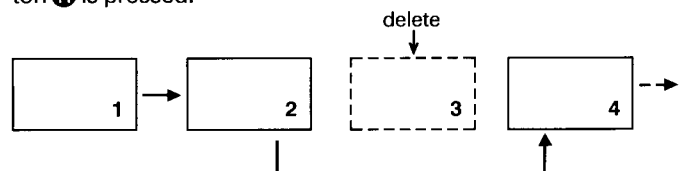

(Special Functions)

■ Memory Add for the Channel Scanning (SPECIAL CODE "72")

- This function is used to add a programme position to the channel scanning positions, so it will be scanned when Channel Scanning button ① is pressed.

For example, to add position "3" to the channel scanning positions:

① Select programme position "3" using the Programme Selector ② or ②-1 .



② Press and hold □/s (Recall) button ⑥ for more than 2 seconds.

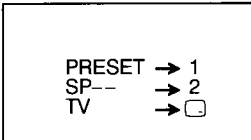

③ Press "2" button of the programme selector ②-1 .

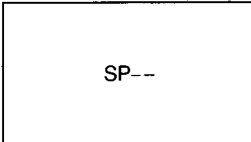

④ Press "7" button, next press "2" button of the programme selector ②-1 .

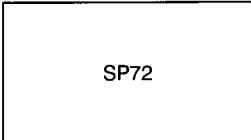

- ⑤ Press ◇ (Memory) button ⑦. ("SP 72" disappears.)

Position "3" is now added to the channel scanning positions.

Position "3" will be scanned when the Channel Scanning button ① is pressed.

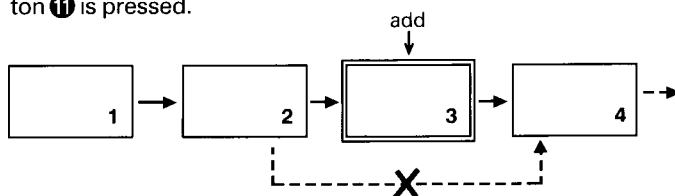

■ Re-set All Special Functions (SPECIAL CODE "01")

- When SPECIAL CODE "01" is input, all the special functions are re-set.

To input Special Code "01":

- ① Press and hold □/s (Recall) button ⑥ for more than 2 seconds.

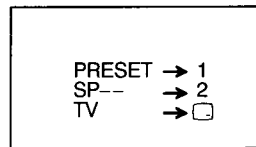

- ② Press "2" button of the programme selector ②-1 .

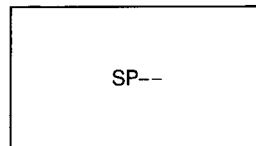

- ③ Press "0" button, and then press "1" button of the programme selector ②-1 .

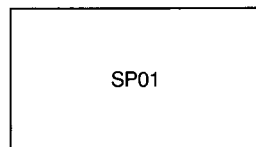

- ④ Press ◇ (Memory) button ⑦. ("SP01" disappears.) All the special functions are now re-set.

■ Re-set All Special Functions (Special Code "00")

- The Special Functions can also be cancelled by inputting Special Code "00".

Note: When Special Functions are cancelled using Special Code "00", the start condition for TV power is changed to the standby start condition, meaning that the picture will not appear even when the Mains ON/OFF Switch ① is set to the on position. To turn on the TV set from the standby mode, press ①-1, ② or ②-1 button.

- Special Code "00" is input in the same manner as Special Code "01".

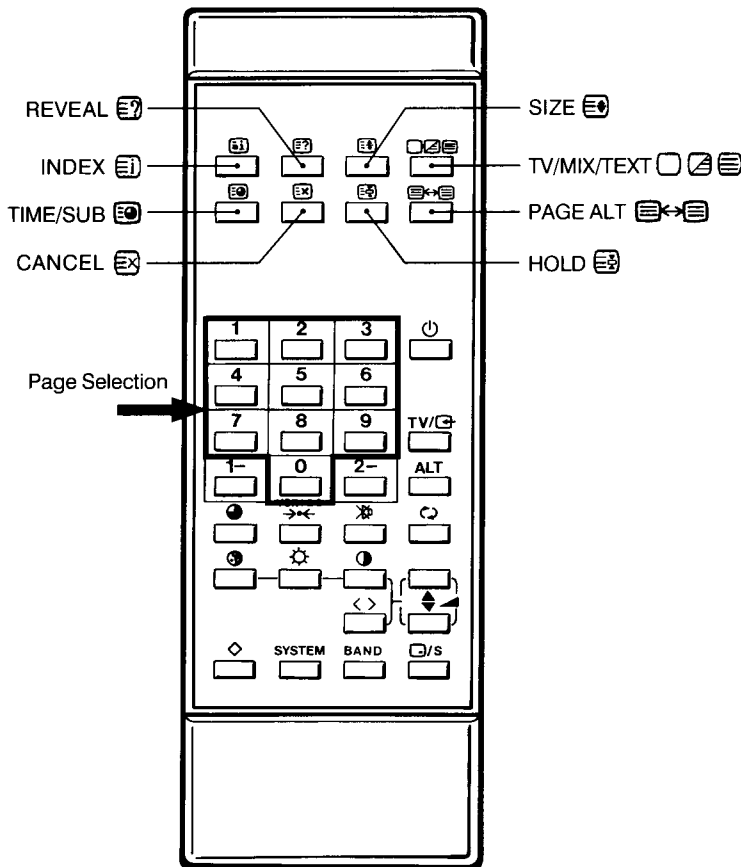

It is not necessary to go back to the index page each time; within any one service you can change direct from one page to another. After a new page has been entered, the previous page is displayed until the new page is received. On reception of the new page, the rolling page number stops, showing the requested page number.

Note: If the new page is a NEWSFLASH or SUBTITLE page, the television video is automatically turned on, and the newsflash or subtitle is displayed in a box within the picture. Conversely, if the old page was a newsflash or subtitle page, and new page is not, then the picture is turned off.

P1 TELETEXT P100 Wed 16 Aug 18:48:22

P15 TELETEXT P100 Wed 16 Aug 18:48:24

P151 TELETEXT P144 Wed 16 Aug 18:48:27

VIEWING TV WHILE SEARCHING FOR A PAGE

In some cases it can take some time to look for a page. In the interval you can view TV by pressing the CANCEL button. When the page arrives, the page number will appear on the normal TV picture. Press TV/MIX/TEXT button to display the page.

Note: When you press the CANCEL button, the green ">" mark is displayed at the top right of the screen. Whilst this ">" mark is displayed you can not select another TV channel.

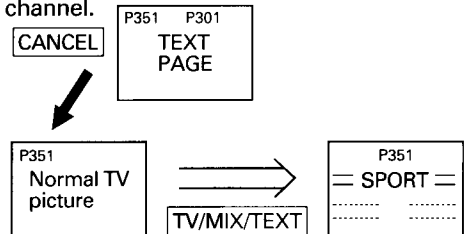

Sub-coded page access

For Teletext information which is longer than one page it may take some time for the automatic changing of sub pages to reach the sub page you require. It is possible, however, to enter the sub-page you require and then continue watching the normal television picture until the correct sub-page is reached.

- Select the required page using the page selection button.
- Press the TIME/SUB button. The sub code digits "----" will be displayed in the top left of the screen.
- Enter the desired sub-page number. For example, if you select sub-page 10 you must press 0, 0, 1 and 0 button.
- Press the CANCEL to return to normal television programme. When the correct sub-page is reached the page number will appear on the normal television picture.
- Press the TV/MIX/TEXT button to display the stored page.
- To clear the sub-coded page you must enter a new page number, or the TIME/SUB button.

Note: It is not possible to select another television station during a sub-page access operation.

Switching to the Teletext Mode

Press the TV/MIX/TEXT button, then the screen changes as follows:

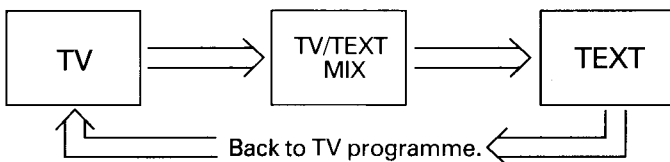

Page Selection

When teletext mode is first selected, the index page (p. 100) is automatically obtained. The requested page is obtained by simply pressing three number buttons in sequence. For example, if you wish to look at page 151, pressing the number, (1), (5) and (1) in turn.

As each command is accepted, the page number at the left-hand end of the header will be built up, digit by digit, until it is complete.

After the final entry has been registered, rolling page numbers are presented until the requested page is received. As soon as the two groups of numbers coincide, the information contained on page 151 appears.

Other pages of the same service can be obtained in this manner, using the appropriate number.

(TELETEXT USE)

■ Page Alternate

Press the Page Alternate  button and the TV set will alternately select the previous page and the present page. For example, now you are watching "page 300" but you watched "page 200" previously. If you press the Page Alternate button, "page 200" appears.

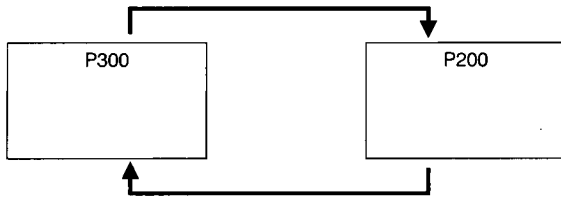

■ Updated Pages

There are pages which are updated as events progress, such as sports results, news reports and traffic information. If you have selected one of the above pages from the list of contents and you want to view television but still be kept informed about the other events, press the CANCEL button. The page will disappear and the TV station which will broadcast this will appear in the screen. As soon as this page is updated, the page number will appear on the normal TV picture. To display the updated page on the screen press the TV/MIX/TEXT button. The page will disappear when the CANCEL button is pressed again.

Note: It is not possible to select another TV station during an UPDATE. You should first switch back to TV reception by pressing the TV/MIX/TEXT button. You can, however, change both the picture and sound settings.

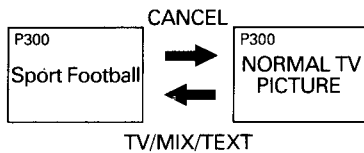

■ HOLD

Some pages contain more information than can be displayed on the screen simultaneously and are therefore subdivided into a series of two or more sub-pages. The first sub-page of a series of four sub-pages, for example, has the indication 1/4 displayed at the top right of the screen (below the time).

These sub-pages are 'rotated', that is, each sub-page is displayed for a certain time (determined by the broadcasting authorities) before being replaced by the next sub-page. If it is desired to halt this rotation and retains a particular sub-page, the HOLD button should be pressed. The word HOLD then appear on the top of the screen.

This command stops the reception of teletext data and can be used to prevent the updating of pages whenever required.

Normal operation is restored by pressing the HOLD button again or entering a new page number.

■ Large Characters (SIZE)

Normally small characters are used in teletext mode, but in some circumstances the 'doubleheight' facility may be useful; when the viewer is some distance from the receiver, for example. Either the top or bottom half of the display can be expanded by pressing the SIZE button. When this button is pressed for the first time, the top half of the display is expanded. If it is pressed once again, the bottom half of the display is expanded.

To return the display to normal-sized characters, this button should be pressed again.

If television mode is selected while large characters are being displayed, small characters will be displayed when the system is next returned to teletext mode.

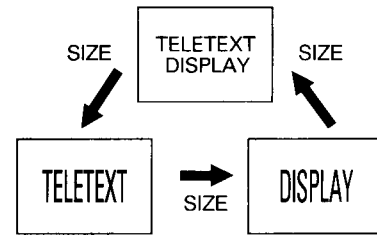

■ INDEX

When this button is pressed in teletext mode, several teletext functions are reset: the page memory is cleared, the command Time Page ON (T. PAGE) is cancelled, and the teletext decoder is set up to display the index page (P100).

■ REVEAL

Some pages have part of the display concealed: a quiz page with concealed answers, for example. The command REVEAL displays the concealed text as long as REVEAL button remains depressed.

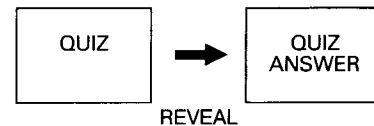

(TELETEXT USE)

Time Coded Pages (TIME/SUB)

Time coding enables the viewer to put into store a specific page of information ready for viewing at a pre-determined time.

IMPORTANT NOTE

With present transmissions this facility is limited to the 'Alarm Clock' pages. Please refer to the transmitted index for the appropriate page number.

The required page is selected in the usual manner and then the command T. PAGE (Time Page On) is entered. The time that the requested page should be received is then entered on the screen using the number keys two digits for hours and two digits for minutes, using the 24 hour clock system. The character 'T' precedes the time digits to indicate that a time code and not the actual code is being displayed, also the four digits flash. After the time code has been entered rolling page numbers are presented. The cancel button is then pressed and the receiver reverts to picture. When the pre-set time is reached the page number will appear in the top left corner of the screen and the data can be seen by pressing cancel again. To clear the time code from the T.V. memory, press TIME/SUB  button again. (Time Page Off).

It is important to remember that once the time coding has been set and the text cancelled pressing any buttons on the handset other than the Brightness, Colour, Volume and Mute may upset the pre-set time.

TIME

If the time is required while a programme is being viewed press the TIME/SUB  button.



Providing that the channel being viewed is also transmitting teletext, the time will appear at the top righthand of the screen for five seconds. The digits displayed represent hours/minutes/seconds.

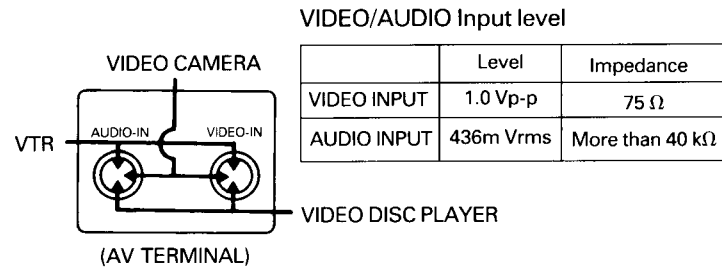

18:05:47

Video/Audio Input Connection





- Connect the video and audio outputs of a VTR, video disk player, etc. to the input jack of this TV set. Tapes and discs can be played back.
- To watch the input picture, press TV/AV Selector .
- To return to the TV mode, press TV/AV Selector  again.

Note: In the AV mode, you can select the TV programme.

- For example, to select the programme position "7" in the AV mode (while watching the playback from a VTR):

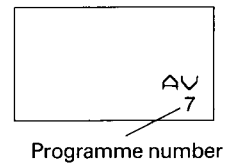
- 1 Press "7" button of the programme selector .



- 2 Press TV/AV Selector , and the picture of the programme position "7" will appear.



AV Connection to the Aerial Socket

- The A.V. apparatus can also be connected to the aerial socket of your TV receiver. In this case, it is advisable to select the "VCR1", "VCR2" or "VCR3" position for the best picture by pressing "0" key of the programme selector.

Each time "0" key is pressed, VCR Position changes as follows:

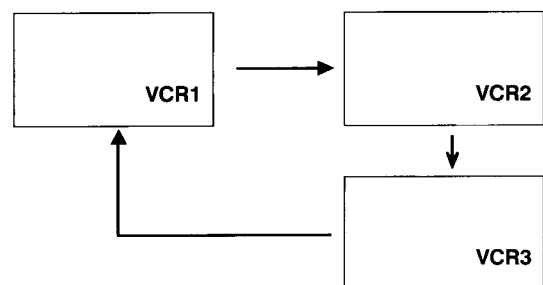

Note: VCR Position is specially designed for the playback of the AV equipments. The picture of the VCR playback may be distorted in other position.

- For further details concerning this connection and adjustment, refer to the operating instructions for the AV equipment.

Pre-Setting of Stations

Up to 32 broadcast stations in your reception area can be stored in the electronic memory.

1 Press and hold  /S (Recall) button **6** for more than 2 seconds.



2 Press "1" button of the programme selector **2-1** to select the pre-set mode.

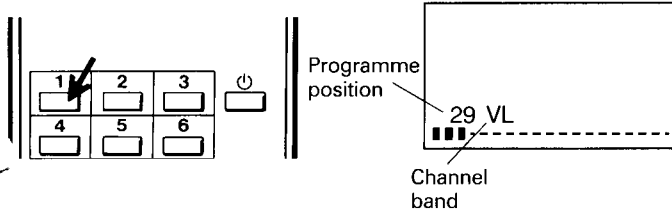

3 Press the programme selector **2-1** to select the desired programme position.



4 Press BAND selector **6** to select the channel band.

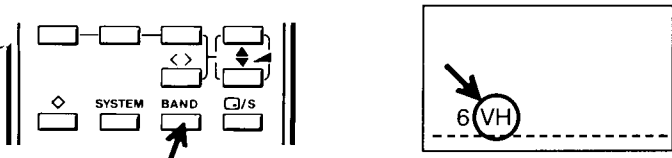

When BAND selector is pressed, the frequency will be set to the lowest frequency in the set band.

- Channel band VL, VH and U are for the following channel groups.

VHF Range

- VHF Low BAND: Channels 1 – 3
- VHF High BAND: Channels 4 – 11

UHF Range

- UHF BAND: Channels 21 – 69

The channel (VL, VH or U) Band is displayed on the screen.

5 Press and hold  (volume) button **4** until the desired station appears.

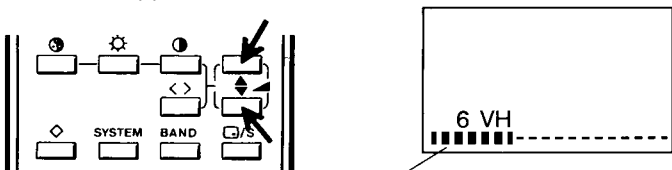

The number of upright segments increases for a higher-frequency channel.

6 Press  (Memory) button **7**.

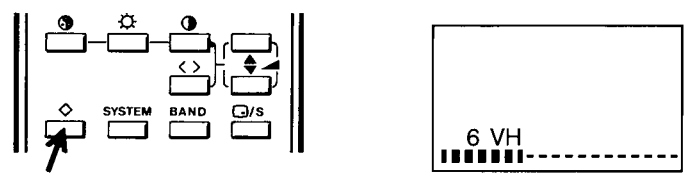

7 Repeat steps **3** to **6** for other desired channels.

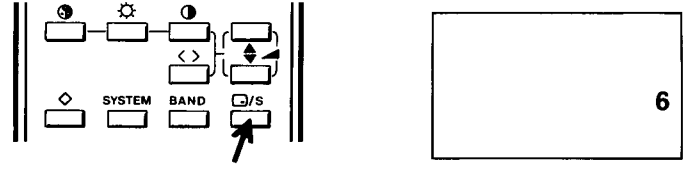

8 Press  /S (Recall) button **6**. This completes the pre-setting.



Memory Copy

This TV tuning system has another advanced feature called "memory copy".

For example, if you wish to copy the TV channel in the programme position "2" into the programme position "6":

1. Select the programme position "2".
2. Press and hold  /S (Recall) button **6** for more than 2 seconds.
3. Press "1" button of the programme selector **2-1** to select the pre-set mode.
4. Press "6" button of the programme selector **2-1**.
5. Press  (Memory) button **7**.
6. Press  /S (Recall) button **6**.

Part No. 4AA6P100491 -- E3RJ (A3 - B)

SANYO

SANYO Electric Co., Ltd.