

SANYO

Instruction
Manual

Colour
Television

Model CZP 3012
CZP 6012
CZP 4012

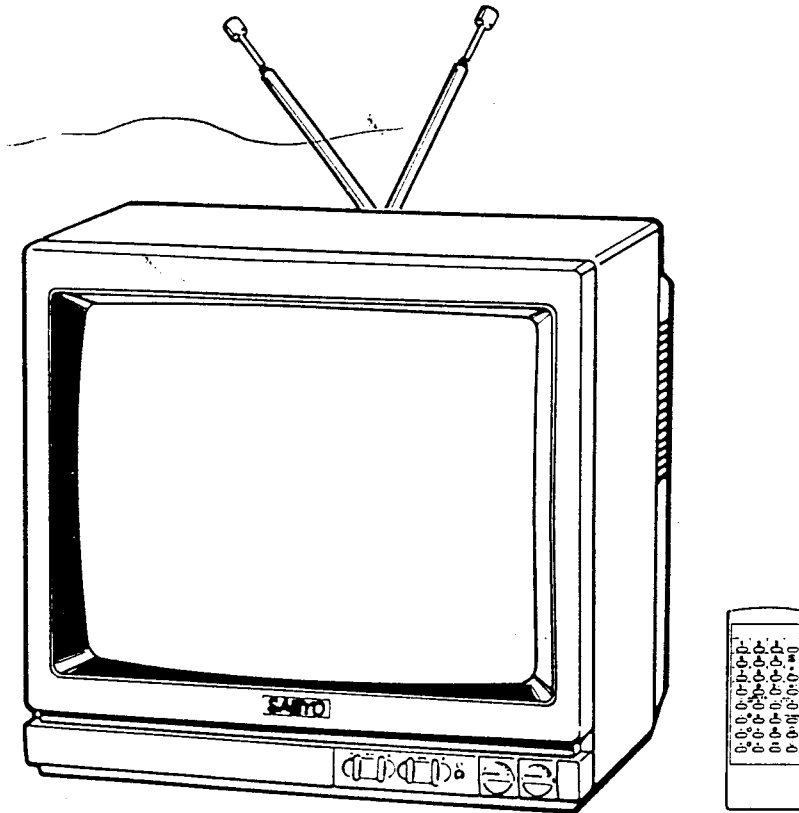

SPECIAL FUNCTIONS
CHANNEL SCANNING

Controls

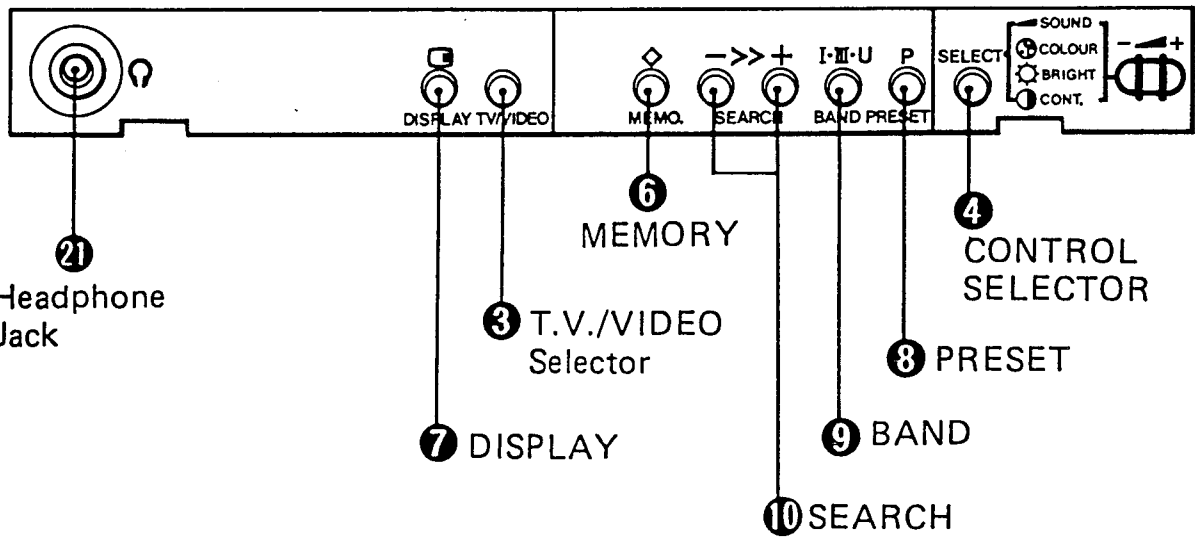
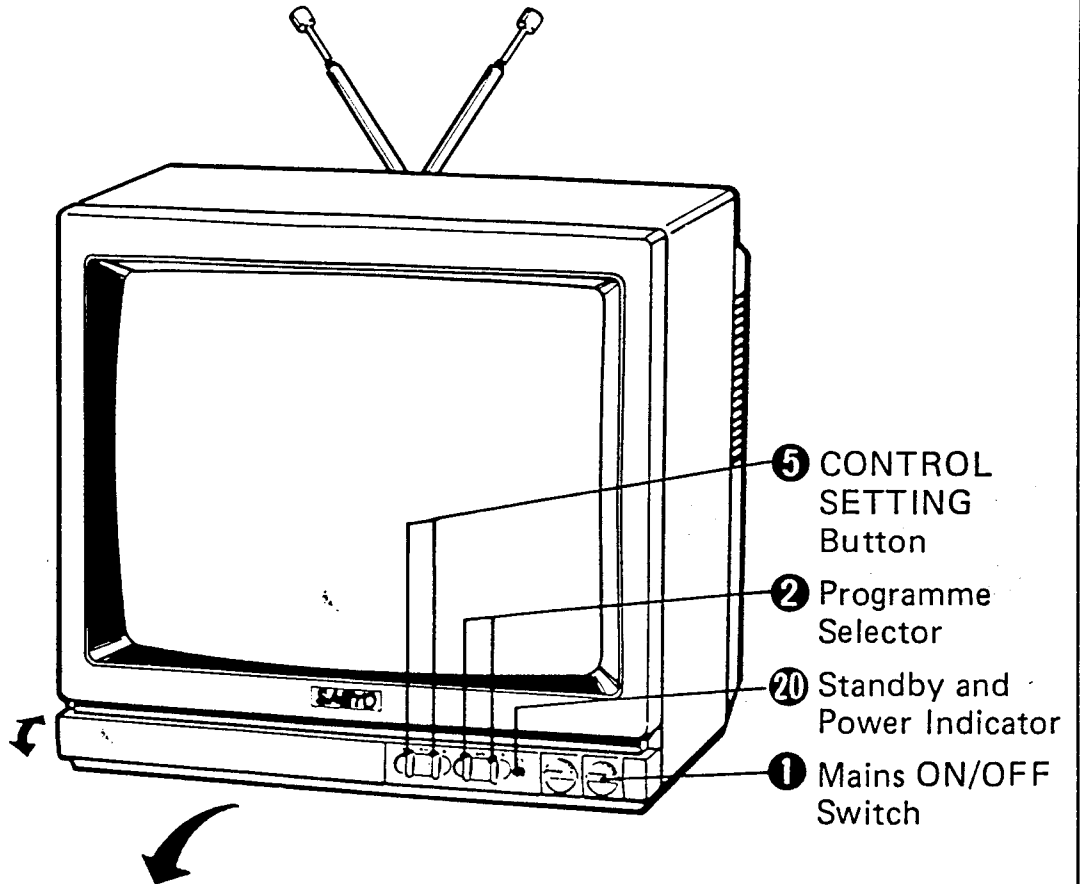

ON-SCREEN DISPLAY: EXAMPLE

- **PROG. POSITION**
Display time continues for 5 sec.
- **SOUND VOLUME**
Display time continues for 5 sec.

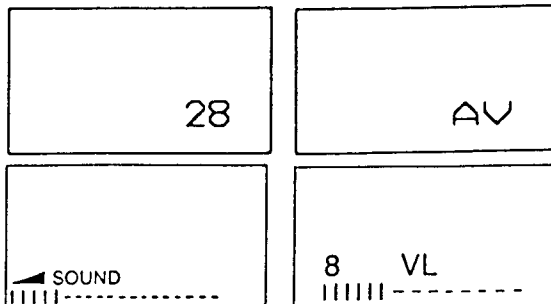

- **VIDEO MODE**
Display time continues for 5 sec.
- **TUNING (Pre-Setting)**
Display time continues during PRESET switch ON.

General Operation

① Mains ON/OFF Switch

The set is switched on by pressing button ①. To switch off, press button again.

NOTE: To switch "ON" the TV set in the standby mode:

Press the Power ON/OFF button ①-1 on the remote control transmitter, the CONTROL SETTING Button ⑤ (on the TV set) or the Programme Selector ② (on the TV set). The TV set can not be turned on by pressing the Mains ON/OFF Switch ① (on the TV set) in the standby mode.

IMPORTANT: Be sure to turn the TV OFF with the Mains ON/OFF Switch ①, if the power failure occurs while viewing.

② Programme Selection

Press the right side (+) of the programme selector ②, and the TV set will step up to the next station, i.e; 1, 2, 3 . . . 29, VCR1, VCR2, VCR3, 1, 2, 3 . . . Press the left side (-), and the TV set will step down to the previous station. The position number is displayed on the screen.

③ T.V./VIDEO Selector Button

To watch television programmes leave this switch in the T.V. mode. When this switch is set to the VIDEO mode you can enjoy the playback from VCR or other AV equipment connected to the AV input terminals. "AV" is displayed on the screen.

CONTROL SETTING

① Select the CONTROL FUNCTION (SOUND VOLUME, COLOUR, BRIGHTNESS or CONTRAST) by pressing the CONTROL SELECTOR ④ button.

* Each time the CONTROL SELECTOR button ④ is pressed, the CONTROL FUNCTION changes as follows;

SOUND VOLUME → COLOUR → BRIGHTNESS → CONTRAST

* "SOUND", "COLOUR", "BRIGHT" or "CONTRAST" is displayed on the screen.

② Adjust the SOUND VOLUME, COLOUR, BRIGHTNESS or CONTRAST to the desired level by pressing the CONTROL SETTING ⑤ button.

⑥ MEMORY ◇

Present SOUND VOLUME, COLOUR, BRIGHTNESS and CONTRAST levels can be set into the memory by pressing the MEMORY ⑥ button, and these control levels can be recalled by pressing the NORMALIZATION ⑬ key on the REMOTE CONTROL TRANSMITTER.

⑦ DISPLAY

The POSITION in present selection and the remaining time in use of setting OFF timer are displayed on the screen by pressing the DISPLAY button. To erase the display, press this button again.

⑳ Headphone Jack

Inserting the headphone (option) to the outlet provides personal listening, (or recording purpose with the appropriate lead.) The TV set speaker is automatically switched off.

- **AUTO SHUT OFF**

This TV set incorporates the AUTO SHUT OFF function which automatically switches OFF the TV set, and switches it to the standby mode about 10 minutes after a TV broadcast finishes or there is no longer a TV signal. Thereafter, the TV set will not switch ON even if the TV signal is input. To switch the TV set ON, use the Power ON/OFF switch **1-1** on the remote control transmitter.

- The remaining time for AUTO SHUT OFF is displayed on the screen.

Remaining time -10 15

Remote Control Operation

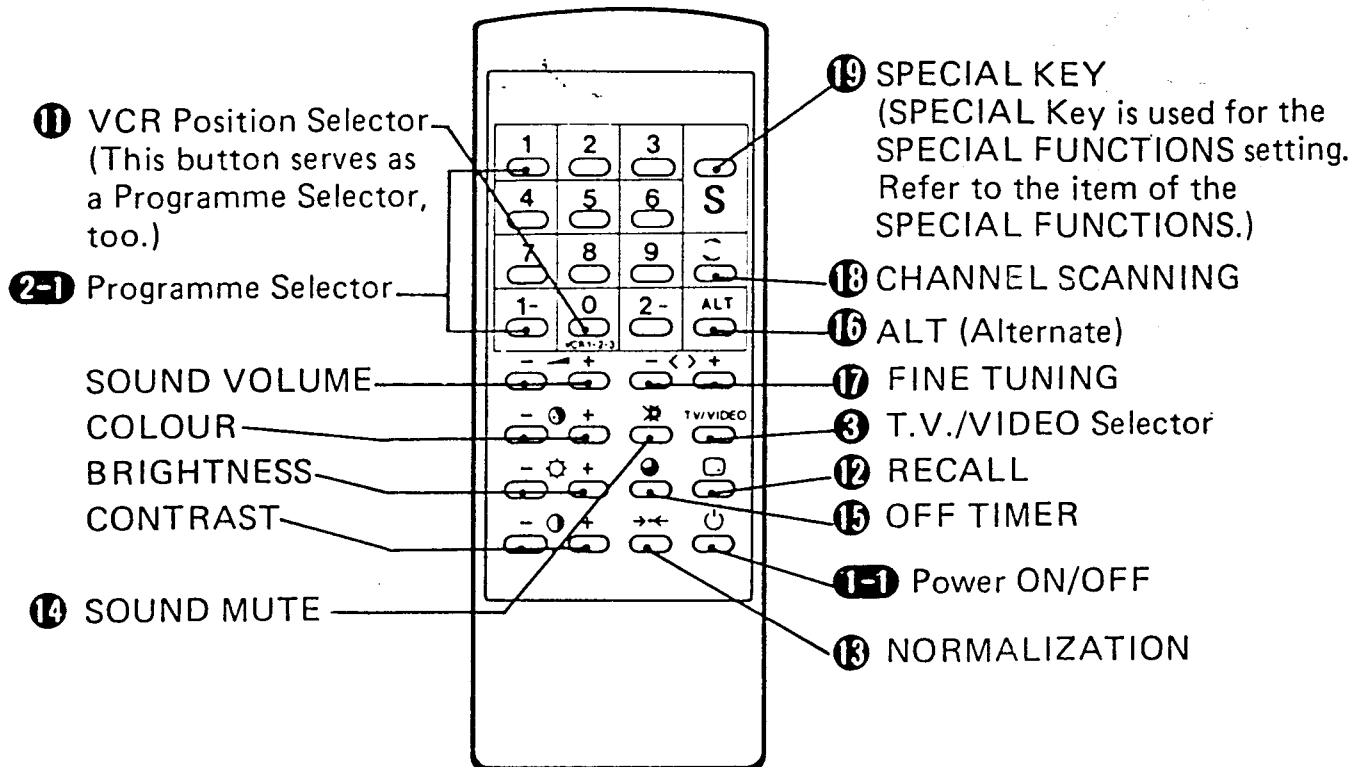

Main ON/OFF switch of the TV set must be in "ON" position before remote control operation is possible.

Point transmitter towards the TV set, then press the appropriate function button for the following controls.

- The keys on the Remote Control Transmitter operate in the same manner as those on the front of the television. In addition to those controls, the transmitter has these additional functions: Programme Selection (direct selection), NORMALIZATION, Sound Mute, OFF TIMER, Alternate, RECALL, FINE TUNING, CHANNEL SCANNING and SPECIAL KEY.

1-1 Power ON/OFF

Press this button to switch TV set on. To switch TV set off, press again.

Note: The Standby and Power Indicator **20** will remain illuminated when the TV set is switched off with this button. This is to indicate that the TV set is still partially energized.

To disconnect TV set completely from mains, switch off with Main ON/OFF switch on the T.V. set itself.

2-1 Programme selection

- For selection of the programme number 1 to 9, press the programme selector button **2-1**.
- For selection of the programme number 10 to 19 or 20 to 29, press the "1-" or "2-" button and then press the "0" to "9" programme selector button **2-1** within five seconds.

11 VCR Position Selector (This button serves as a Programme Selector, too.)

When using a VCR connected to the aerial socket, VCR Position must be selected by pressing this button.

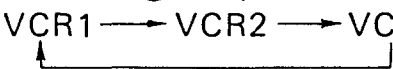
- Each time the VCR Position Selector **11** is pressed, the VCR Position number will change as follows: VCR1 → VCR2 → VCR3

- The characters of "VCR1", "VCR2" or "VCR3" are displayed on the screen.

12 RECALL 

The POSITION in present selection and the remaining time in use of setting OFF timer are displayed on the screen for 5 seconds by the RECALL Key.

NOTE: The RECALL Key has a same function as the SPECIAL Key **19**.
(When the RECALL Key is pressed for more than 2.5 seconds, "SP--" is displayed on the screen.)

13 NORMALIZATION →•←

When this button is pressed, automatically SOUND VOLUME, COLOUR, BRIGHTNESS and CONTRAST are set at the levels which have been memorized by the MEMORY **6** button.

14 Sound mute 

Should you wish to mute the sound (e.g. While talking on the telephone). Press this button once. To switch the sound back on, press it again.

15 OFF TIMER 

After a set time has elapsed, the power of the T.V. receiver is switched off automatically. Each time the key is pushed, the set time changes as follows:

Channel number display → 30 minutes → 60 minutes → 90 minutes → 120 minutes

With the off timer being set and the channel display reset, the remaining time is displayed by pushing the off timer key again. When the key is pushed again within three seconds after the key was first pushed in above manner, the time is set to a upper time which is most close to the remaining time.

- Just one minute before switching off, "-01" and programme number you are watching are displayed on the screen.
- The timer setting will be cancelled if the power is switched OFF.

16 ALT (Alternate)

Press the "ALT (Alternate)" button **16** and the T.V. set will alternately select the previous channel and the present channel. For example, now you are watching channel 4 but you watched channel 2 previously. If you press the "ALT Key", channel 2 immediately appears then channel 4 is stored in the memory.

17 FINE TUNING < >

For tuning of the best picture and sound, press the (±) Fine Tuning button.

- The programme number is displayed on the screen when the FINE TUNING buttons are depressed. Display time continues while these buttons (±) are depressed and for 5 seconds after detaching them.

18 CHANNEL SCANNING

Press the CHANNEL SCANNING Key 18 to search for a programme. The channel positions are automatically scanned, and the channel scanning will stop at the position where it began. To stop at the position you want, press this key again.

ON-SCREEN DISPLAY: EXAMPLE

- OFF TIMER
- SOUND MUTE
- NORMALIZATION

Set time -90 28

NORMAL

SOUND MUTE

Display time continues for 5 sec.

Video/Audio Input Connection

In order to watch the playback from a VCR, video disc player or the video signal from a video camera, the output terminal of the A.V. equipment in use must be connected to the VIDEO/AUDIO INPUT terminal. Note that the T.V./VIDEO switch must be set to the VIDEO mode to watch any A.V. program.

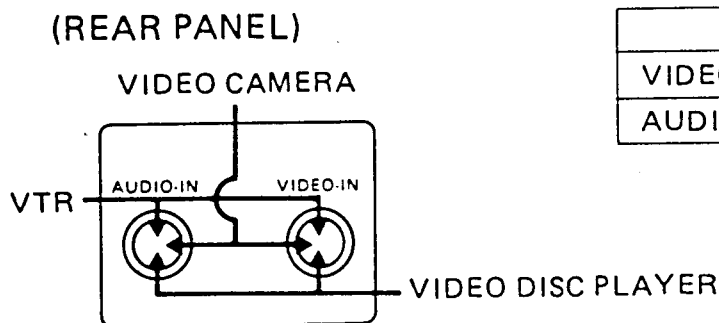

VIDEO/AUDIO Input level

| | Level | Impedance |
|-------------|----------|----------------|
| VIDEO INPUT | 1.0Vp-p | 75Ω |
| AUDIO INPUT | 436mVrms | More than 40kΩ |

NOTE: In the VIDEO mode, you can select the T.V. programme.

- If you wish to select the programme number "7" in the VIDEO mode (while watching the playback from a VCR);

1 Select the programme number "7" by the Programme Selector button 2 or 2-1.

2 Press the T.V./VIDEO Selector 3, and the picture of the programme number "7" will appear.

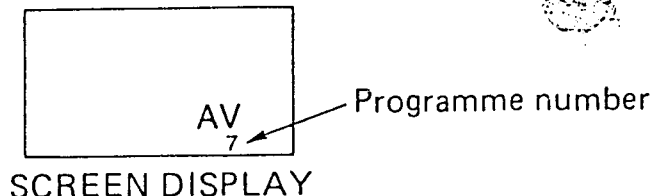

A.V. (Audio Video) connection to the Aerial socket

The A.V. apparatus can also be connected to the aerial socket of your T.V. receiver. In this case, it is advisable to select the "VCR1", "VCR2" or "VCR3" position for the best picture by the VCR Position Selector 1.

VCR Position is specially designed for the VCR playback. The picture of the VCR playback may be distorted in other position.

For further details concerning this connection and adjustment, refer to the operating instructions for the A.V. apparatus.

Pre-Setting of Stations

Up to 32 broadcast stations in your reception area can be stored in the electronic memory.

- 1 Set the **8** PRESET switch to ON position.
- 2 Select the programme number (with programme selector button **2** or **2-1**) for which you would like to preset a program.
Set the **9** BAND SWITCH to the channel band corresponding to your desired channel.
Channel band VL, VH and U are for the following channel groups.

VHF range

Band VL Channels 1 — 3

Band VH Channels 4 — 10

UHF range

Band U Channels 21 — 69

The channel (VL, VH or U) Band is displayed on the screen.

SCREEN DISPLAY

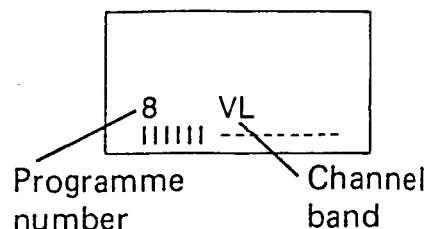

REMARKS

When the band is set using the BAND SWITCH, the frequency will be set to the lowest frequency in the set band.

- 3 Press and hold the **10** (+) SEARCH button to station searching.
When a station is found, release the (+) SEARCH button as soon as picture appears.
When searching stops, the TV picture and sound will probably be rough.
Press and hold the **17** (+) FINE TUNING button until both picture and sound reception clear.

REMARKS

The lowest bar display changes according to UP/DOWN of tuning voltage.

If the station found in above step is not the one to be set, press the (+) SEARCH BUTTON again until the desired station appears.

- 4 Once the best picture have been obtained, press the **6** MEMORY button to store the station located by the tuning in the electronic memory.
- 5 Repeat steps **2** — **4** for remaining program numbers to be set.
- 6 Be sure the **8** PRESET switch is in OFF position.
When the PRESET switch is switched OFF, BAND SWITCH, the (+) and (–) SEARCH buttons will not function.

Memory Copy

This T.V. tuning system has another advanced feature called "memory copy".

A station entered into the memory at a particular programme number can also be received at any other programme number, to use this feature follow the procedure below.

If you wish to copy the T.V. channel in the programme number "2" into the programme number "15".

1. Select the programme number "2". (with the prog. selector **2** or **2-1**.)
2. Turn the PRESET switch **8** ON.
3. Select the programme number "15". (with the prog. selector **2** or **2-1**.)
4. Press the MEMORY button **6**, set the PRESET switch **8** to OFF.

Special Functions

- You can set the SPECIAL FUNCTIONS to input the SPECIAL CODES using the SPECIAL Key **19** and the Programme Selector **2-1** of the remote control transmitter.

The SPECIAL CODES and SPECIAL FUNCTIONS are as follows.

| SPECIAL CODE | SPECIAL FUNCTIONS |
|--------------|--|
| 01 | RE-SET ALL SPECIAL FUNCTIONS |
| 70 | SEARCH FOR CHANNEL SCANNING |
| 71 | MEMORY DELETE FOR CHANNEL SCANNING (Used to delete a programme position from the channel scanning positions.) |
| 72 | MEMORY ADD FOR CHANNEL SCANNING (Used to add a programme position to the channel scanning positions.) |
| 90 | SECRET POSITION (SET AND RE-SET) (Used to restrict the viewing of some programme positions.) |

NOTE: Special functions are not cancelled when the power is turned off or when the AC power plug is disconnected from the mains.

■ SETTING OF THE SECRET POSITION (SPECIAL CODE "90")

- The SECRET POSITION is used to restrict the viewing of programme positions that you do not want others to watch.
- Any positions can be set as the SECRET POSITIONS.

EXAMPLE

How to set the SECRET POSITION at programme position "15".

- 1 Select programme position "15" using the Programme Selector **2** or **2-1**.



15

- 2 Press and hold the SPECIAL Key **19** of the remote control transmitter for more than 2.5 seconds. "SP--" will be displayed on the screen.

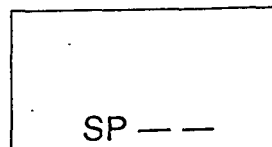

SP --

- 3 Input the SPECIAL CODE "90" using the Programme Selector **2-1** of the remote control transmitter.

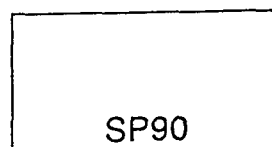

SP90

- 4 Press the MEMORY button **6** in the front control section of the TV set. The picture will then disappear, and "X 15" will be displayed on the screen.

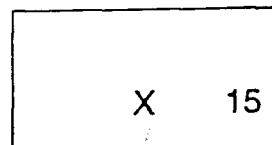

X 15

The SECRET POSITION setting is now completed.

When position "15" is selected using the Programme Selector **2** or **2-1** after the SECRET POSITION setting has been completed, only the characters "X 15" will appear.

HOW TO WATCH A PROGRAMME ON THE SECRET POSITION:

- 1 Select the SECRET POSITION (position "15") using the Programme Selector **2** or **2-1**.

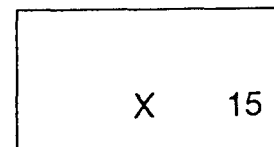

X 15

- 2 Press and hold the SPECIAL Key **19** of the remote control transmitter for more than 2.5 seconds. "SP--" will be displayed on the screen.

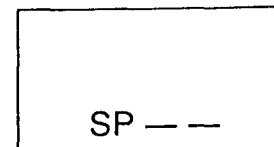

SP --

- 3 Input SPECIAL CODE "90" using the Programme Selector **2-1** of the remote control transmitter. The programme of the SECRET POSITION will then appear. Next, press the SPECIAL Key **19**, and "SP90" will disappear.

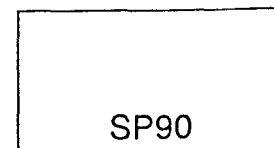

SP90

NOTE: If you watch a programme on the SECRET POSITION, then select another programme position, you will have to repeat the above procedures before you can watch a programme on the SECRET POSITION again.

As many SECRET POSITIONS as you want can be set.

HOW TO RE-SET THE SECRET POSITION:

- This is done in the same manner as the SECRET POSITION setting.

For example, to re-set programme position "15" in the SECRET POSITION:

- 1 Select programme position "15" (SECRET POSITION) using the Programme Selector **2** or **2-1**.
("X 15" will be displayed on the screen.)
- 2 Press and hold the SPECIAL Key **19** of the remote control transmitter for more than 2.5 seconds.
("SP--" will be displayed on the screen.)
- 3 Input SPECIAL CODE "90" using the Programme Selector **2-1** of the remote control transmitter.
- 4 Press the MEMORY button **6** of the front control section of the TV set.
Position "15" is now re-set in the SECRET POSITION.

■ SEARCH FOR THE CHANNEL SCANNING (SPECIAL CODE "70")

- When SPECIAL CODE "70" is input, all the programme positions are automatically scanned, and the active programme positions are stored in memory.
Once this programming is completed, the TV receiver will select only the stored programme positions when the CHANNEL SCANNING Key **18** is pressed.

HOW TO INPUT SPECIAL CODE "70":

- 1 Press and hold the SPECIAL Key **19** of the remote control transmitter for more than 2.5 seconds.
("SP--" will be displayed on the screen.)

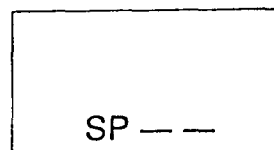

- 2 Input SPECIAL CODE "70" using the Programme Selector **2-1** of the remote control transmitter.

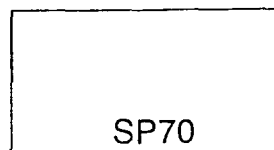

- 3 Press the MEMORY button **6**. The programme positions are then automatically scanned, and the active programme positions are stored in memory.
The channel scanning will then stop at the position where it started scanning.

SEARCH FOR CHANNEL SCANNING is now completed.

■ MEMORY DELETE FOR CHANNEL SCANNING (SPECIAL CODE "71")

- This function is used to delete a programme position from the channel scanning positions, so it will not be scanned when the CHANNEL SCANNING Key **18** is pressed.

For example, to delete position "2" from the channel scanning positions:

1 Select programme position "2" using the Programme Selector **2** or **2-1**.

2 Press and hold the SPECIAL Key **19** for more than 2.5 seconds, and input SPECIAL CODE "71" using the Programme Selector **2-1** of the remote control transmitter.

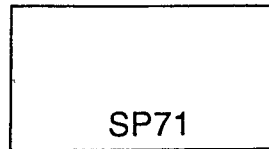
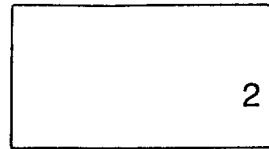

3 Press the MEMORY button **6** of the front control section of the TV set.

Position "2" is now deleted from the channel scanning positions.

Position "2" will be passed over when the CHANNEL SCANNING Key **18** is pressed.

■ MEMORY ADD FOR CHANNEL SCANNING (SPECIAL CODE "72")

- This function is used to add a programme position to the channel scanning positions, so it will be scanned when the CHANNEL SCANNING Key **18** is pressed.

For example, to add position "2" to the channel scanning positions:

1 Select programme position "2" using the Programme Selector **2** or **2-1**.

2 Press and hold the SPECIAL Key **19** for more than 2.5 seconds, and input SPECIAL CODE "72" using the Programme Selector **2-1** of the remote control transmitter.

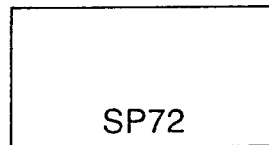

3 Press the MEMORY button **6** of the front control section of the TV set.

Position "2" is now added to the channel scanning positions.

Position "2" will be scanned when the Channel Scanning Key **18** is pressed.

■ RE-SET ALL SPECIAL FUNCTIONS (SPECIAL CODE "01")

- When SPECIAL CODE "01" is input, all the special functions are re-set.

HOW TO INPUT THE SPECIAL CODE:

- 1 Press and hold the SPECIAL KEY **19** for more than 2.5 seconds, and input SPECIAL CODE "01" using the Programme Selector **2-1**.

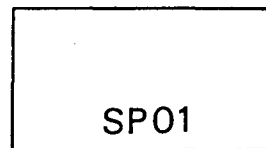

- 2 Press the MEMORY button **6** of the front control section of the TV set.

 All the special functions are now re-set.

NOTE: The SPECIAL FUNCTIONS can also be cancelled by inputting SPECIAL CODE "00".

When SPECIAL FUNCTIONS are cancelled using SPECIAL CODE "00", the start condition for TV power is changed to the standby start condition, meaning that the picture will not appear even when the MAINS ON/OFF Switch **1** is set to the on position. To turn on the TV set from the standby mode, press **1-1**, **2** **5** button.

SPECIAL CODE "00" is input in the same manner as SPECIAL CODE "01".

OTHER SPECIAL FUNCTIONS

- The start condition for TV power can be changed by inputting SPECIAL CODE "50" or "51".

WHEN SPECIAL CODE "50" IS INPUT:

- Even if the Mains ON/OFF Switch ① is set to the on position, the picture will not appear. (The TV set remains in the standby mode.) To turn on the TV set from the standby mode, press ①-①, ② or ⑤ button.

Inputting SPECIAL CODE "50":

- Press and hold the SPECIAL Key ⑨ for more than 2.5 seconds, and input SPECIAL CODE "50" using the Programme Selector ②-①.

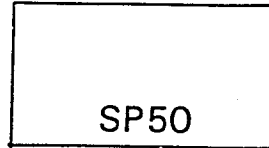

- Press the MEMORY button ⑥ on the front controls of the TV set.

NOTE: To return to TV's power start condition to its original condition, input SPECIAL CODE "51".

SPECIAL CODE "51" is input in the same manner as SPECIAL CODE "50".

HELPFUL HINTS

NO PICTURE, NO SOUND

- Check if TV is plugged in.
- Try a different channel, if OK, probably station trouble.

POOR PICTURE, SOUND OK

- Adjust BRIGHTNESS control.
- Adjust FINE TUNING control.
- Check aerial connections.

NO COLOUR, PICTURE OK

- Adjust COLOUR control.
- Adjust FINE TUNING control.
- Is the program in colour?

WEAK PICTURE

- Check aerial connections on back of set.
- Check aerial for broken wires.
- Re-orient aerial.

The following faults are not caused by the receiver.

"GHOSTS"

Reflections of signals from mountains or high buildings will cause multiple images, called "Ghosts".

These abnormal conditions can be reduced to minimum by repositioning aerial or by installing new one suited for your area.

"INTERFERENCE"

Interference may be caused by electrical appliances, car ignition systems, etc. This should normally be a temporary condition, but should this interference persist, contact your dealer.

Slots and openings in the cabinet and in the back or bottom are provided for ventilation, and to ensure reliable operation of the television receiver and to protect it from overheating, these openings must not be blocked or covered.

BATTERY INSTALLATION (REMOTE CONTROL TRANSMITTER)

- 1 Remove the battery cover by sliding.
- 2 Install two "AA" 1.5 volt batteries so that the "+" and "-" marks on the batteries match the "+" and "-" marks inside the unit.
- 3 Close the battery cover.

NOTE:

Replace the batteries when the T.V. set is showing the following symptoms: Operation is unsteady or erratic, sometimes the T.V. set does not work with remote control transmitter. Discharged batteries may leak and damage the unit. The normal life of batteries should be from nine to ten months.

MOUNTING TELESCOPIC AERIAL

(Model CZP6012: Telescopic Aerial is an optional extra.)

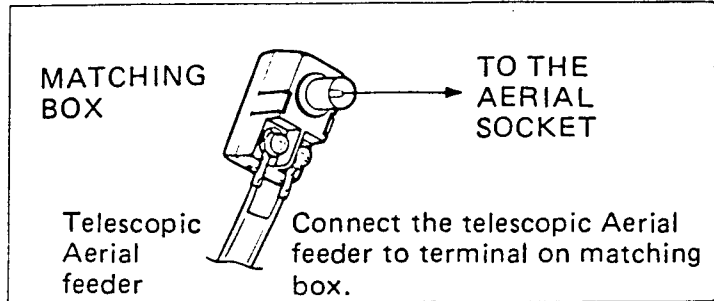
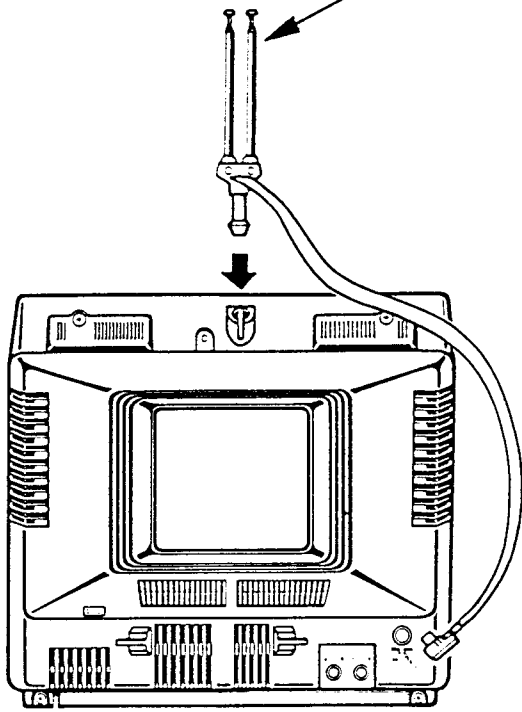

NOTE:

When using an outdoor aerial, disconnect the telescopic aerial feeder.
Then connect the outdoor aerial feeder to terminal on matching box.

AERIAL

The type of aerial required depends on factors such as the site, its distance and direction from the transmitter, local interference etc. Your dealer will advise you the best type of aerial to be used.

The aerial socket is on the back panel of the TV set.

MAINS SUPPLY

The receiver is designed to operate on an A.C. mains supply of 230 volts 50Hz.

SPECIFICATIONS

| | |
|----------------------------------|---------------------------|
| Power Source | AC 230V, 50Hz |
| Television System | System B/G |
| Colour System | PAL |
| Channel Coverage | VHF: 1-10 UHF: 21 – 69 |
| Aerial Input Impedance | 75 ohm |

