

INSTRUCTION MANUAL

DC-D9

Mini Component System

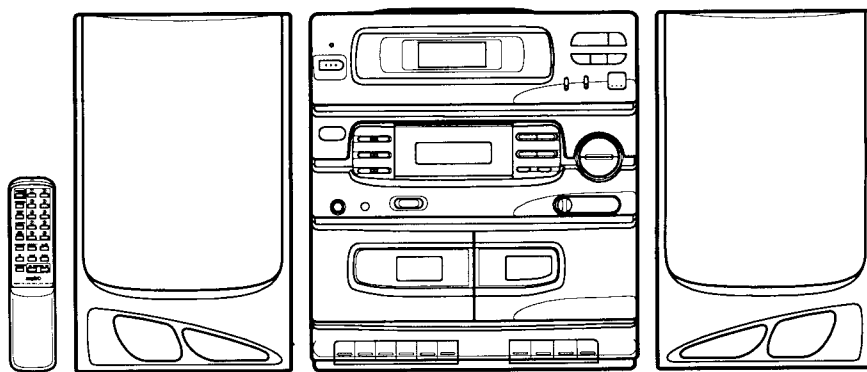

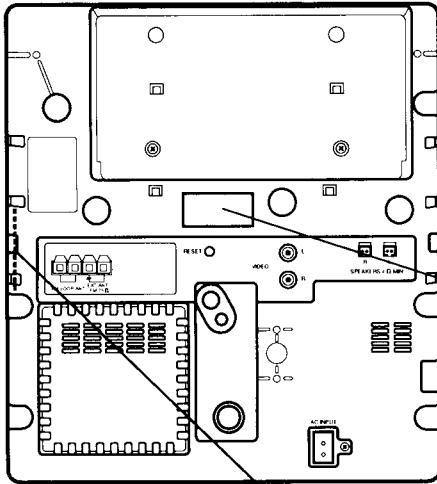

CAUTION - USE OF CONTROLS OR ADJUSTMENTS OR PERFORMANCE OF PROCEDURES OTHER THAN THOSE SPECIFIED IN THE OPERATING INSTRUCTIONS MAY RESULT IN HAZARDOUS RADIATION EXPOSURE.

THE COMPACT DISC PLAYER SHOULD NOT BE ADJUSTED OR REPAIRED BY ANYONE EXCEPT PROPERLY QUALIFIED PERSONNEL.

**CLASS 1 LASER PRODUCT
LUOKAN 1 LASERLAITE
KLASS 1 LASERAPPARAT**

CAUTION - INVISIBLE LASER RADIATION WHEN OPEN AND INTERLOCKS DEFEATED. AVOID EXPOSURE TO BEAM.
ADVARSEL - USYNLIG LASER STRÅLING VED ÅBNING, NÅR SIKKERHEDSAFBRYDERE ER UDE AF FUNKTION, UNDGÅ UDSÆTTELSE FOR STRÅLING.
VARNING - OSYNLIG LASER STRÅLNING NÅR DENNA DEL ÄR ÖPPNAD OCH SPÄRR ÄR URKOPPLAD. STRÅLEN ÄR FARLIG.
VORSICHT - UNSICHTBARE LASERSTRAHLUNG TRITT AUS, WENN DECKEL GEÖFFNET UND WENN SICHERHEITSVERRIEGELUNG ÜBERBRÜCKT IST. NICHT, DEM STRAHL AUSSETZEN.
VARO! Avattaessa ja suojalukitus ohitettaessa olet alltiina näkymättömälle lasersäteilylle. Älä katso äteeseen.



PRECAUTIONS

- If water should enter the unit, electrical shock or malfunction may result. Always use it in a place where there is low humidity and little dust.
- Do not use where there are extremes of temperature (below 5°C or exceeding 35°C) or where direct sunlight may strike it.
- Because of the CD player's extremely low noise and wide dynamic range, there might be a tendency to set the volume on the amplifier unnecessarily high. Doing so may produce an excessively large output from the amplifier which could damage your speakers.
- Sudden changes in the ambient temperature may cause condensation to form on the optical lens inside the unit. If this happens, take out the disc, leave the unit for about 1 hour, and then proceed to operate.
- When carrying the unit, be sure to remove any discs which may be inside and turn the power off. The STANDBY indicator lights. Then unplug the mains lead from the AC outlet. Carrying the unit with any discs inside may damage the discs and/or the unit.
- The system's speakers use powerful magnets. Do not place time-pieces, credit cards, cassette tapes or video tapes, etc. near the speakers.

CONNECTIONS

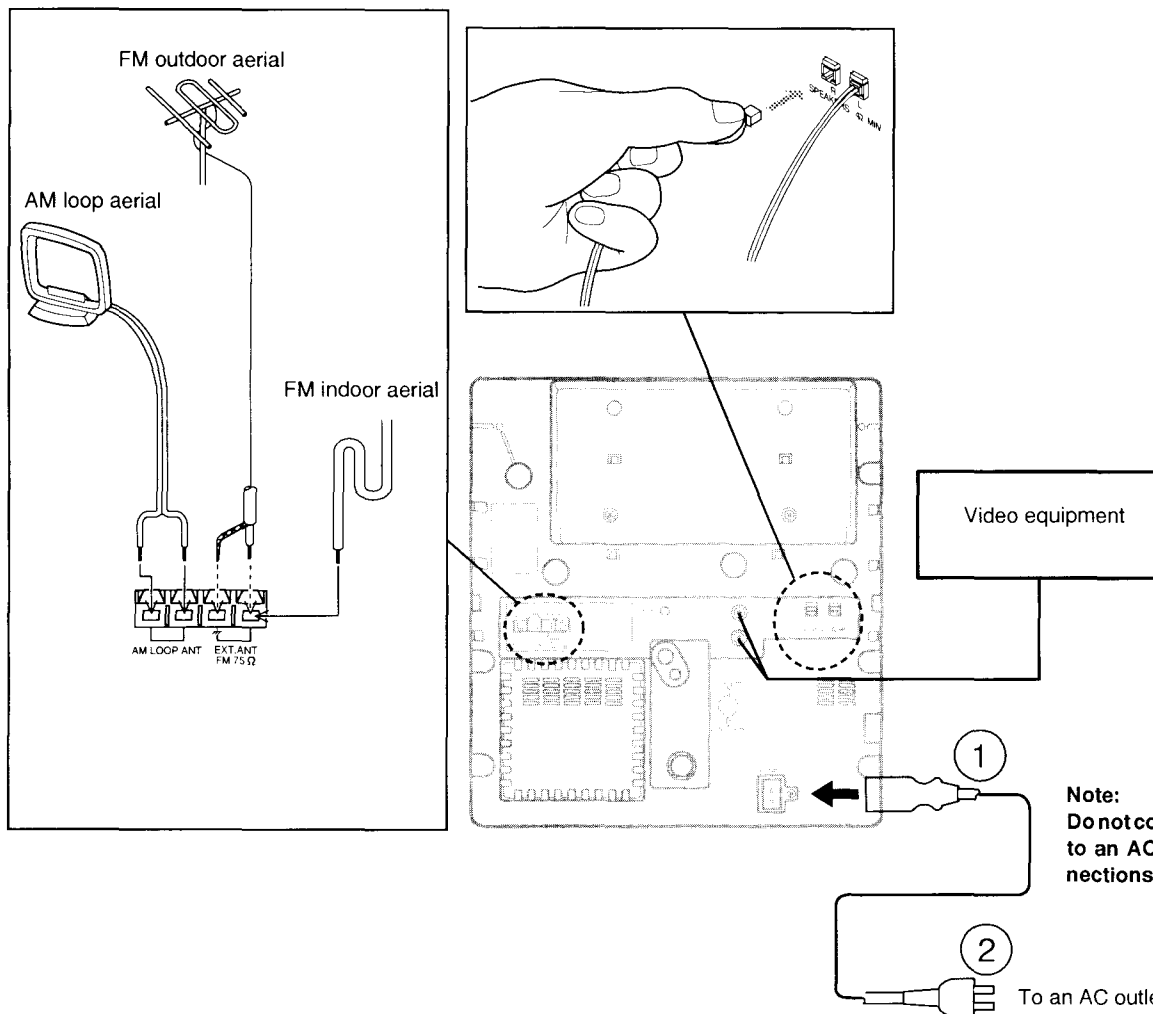

When the unit is first connected, the display switches automatically to the demonstration mode.
To cancel this mode, turn the power on.

The system is not disconnected from the mains unless the mains lead is unplugged from the AC outlet.

Speakers

Connect the connector of the left speaker lead to the "L" SPEAKERS socket and the connector of the right speaker lead to the "R" socket.
If you have difficulty inserting the speaker lead connector, turn it over and reinsert it.

FM aerial

The FM indoor aerial is sufficient to receive most local FM broadcasts and should be connected to the EXT. ANT terminal. Extend the aerial wire as straight as possible and, while listening to the sound from the system, secure it in a position which yields minimal distortion and noise.
In fringe areas or where reception is distorted or noisy, an FM outdoor aerial (not supplied) should be connected instead of the indoor aerial. The terminals will accept 75-ohm coaxial cable. Consult your dealer.

AM loop aerial

Assemble the loop aerial as shown in figure.

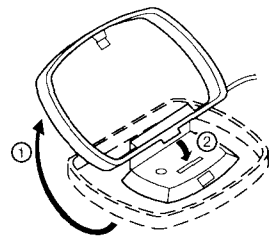

Unwind the aerial wires, then connect them to the AM LOOP ANT terminals. Place the loop aerial in a position which yields the best AM reception, or attach it to a wall or other surface as shown in figure.

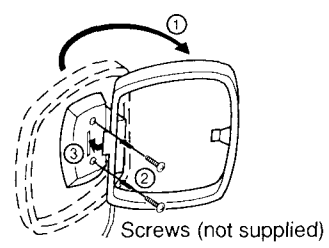

Note:
To minimize noise, the speaker, mains and any other leads should not come close to the FM indoor or outdoor aerial lead and AM loop aerial. Do not place the aerial leads close to the system.

Video equipment

Connect leads (not supplied) from the audio output sockets of a video equipment to the VIDEO sockets.

Headphones

Connect stereo headphones (not supplied) to the PHONES socket for monitoring or for private listening. The speakers are automatically disconnected when headphones are connected.

CONTROLS

CD player/Amplifier/Tuner section

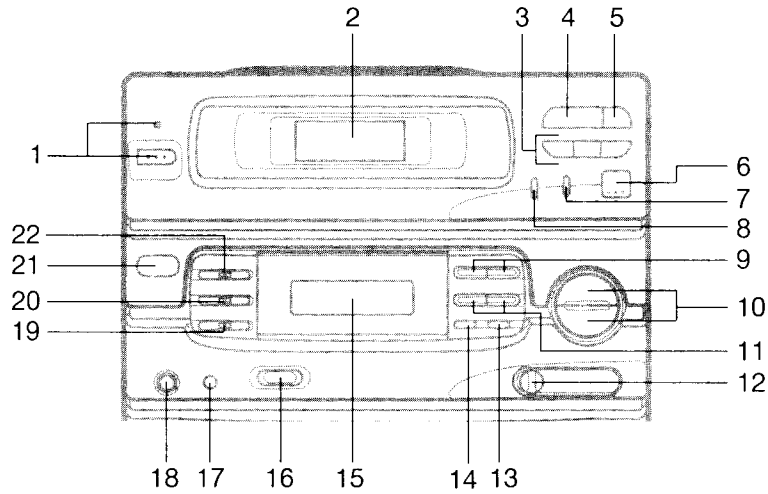

- | | |
|---------------------------------------------------------------------------------|------------------------------------------------------------|
| 1. Power button/Standby indicator (POWER/STANDBY) | 12. Balance control (BALANCE) |
| 2. Disc trays (DISC 1/DISC 2/DISC 3) (inside the door) | 13. FM mode select button (MODE) |
| 3. Disc select buttons (DISC) | 14. Band select button (BAND) |
| 4. Play/Pause button (PLAY/PAUSE) | 15. Display |
| 5. Stop button (STOP) | 16. Function button (FUNCTION) |
| 6. Disc tray open/close button (OPEN/CLOSE) | 17. Dubbing speed/Beat cancel button (DUBBING/BEAT CANCEL) |
| 7. Repeat button (REPEAT) | 18. Headphones socket (PHONES) |
| 8. Memory button (MEMORY) | 19. Bass expander control (BASSXPANDER) |
| 9. CD Skip/Search (◀◀/◀◀ CD TRACK ▶▶/▶▶) and TUNER
Tuning (TUNING) buttons | 20. Mid range control (MID) |
| 10. Volume buttons (VOLUME) | 21. Remote sensor (IR) |
| 11. Preset tuning buttons (PRESET) | 22. Treble control (TREBLE) |

Cassette deck section

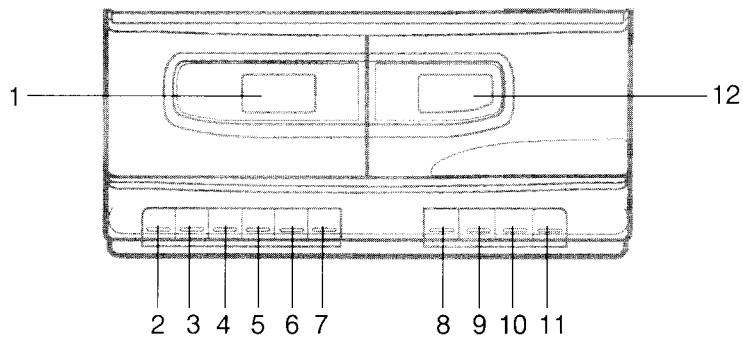

Deck B

1. Cassette holder
2. Record button (REC)
3. Play button (PLAY)
4. Rewind button (REW)
5. Fast forward button (F FWD)
6. Stop/Eject button (STOP/EJECT)
7. Pause button (PAUSE)

Deck A

8. Play button (PLAY)
9. Rewind button (REW)
10. Fast forward button (F FWD)
11. Stop/Eject button (STOP/EJECT)
12. Cassette holder

REMOTE CONTROL

Controls

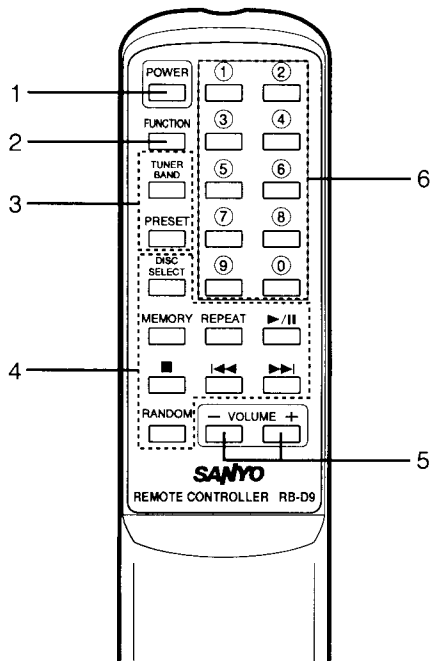

1. Power button (POWER)
2. Function button (FUNCTION)
3. Tuner controls
TUNER/BAND: Tuner function/Band select button
PRESET: Preset tuning up button
4. CD player controls
DISC SELECT: Disc select button
MEMORY: Memory button
(This button can also be used as a tuner memory button.)
REPEAT: Repeat button
▶/||: Play/Pause button
■: Stop button
◀◀, ▶▶: Skip/Search buttons
RANDOM: Random play button
5. Volume buttons (VOLUME)
6. Number buttons (1 - 9, 0)

Number buttons (1 - 9, 0)

These buttons are used to select the track numbers on a disc or preset radio stations.

If the function is "CD", the buttons select the track numbers on a disc.

If the function is "TUNER", the buttons select preset radio stations.

With any other function, the buttons will not function.

- Two buttons must always be pressed.

Example:

To select No. 3, press 0, then 3.

To select No. 10, press 1, then 0.

To select No. 25, press 2, then 5.

Inserting batteries

1

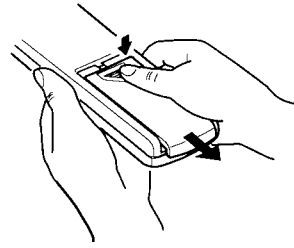

2

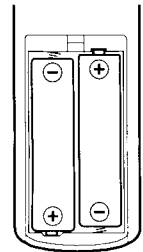

Two AA/SUM-3/R6 batteries
(not supplied)

Note:

Always remove batteries if the remote control is not to be used for a month or more. Batteries left in the unit may leak and cause damage.

Remote control range

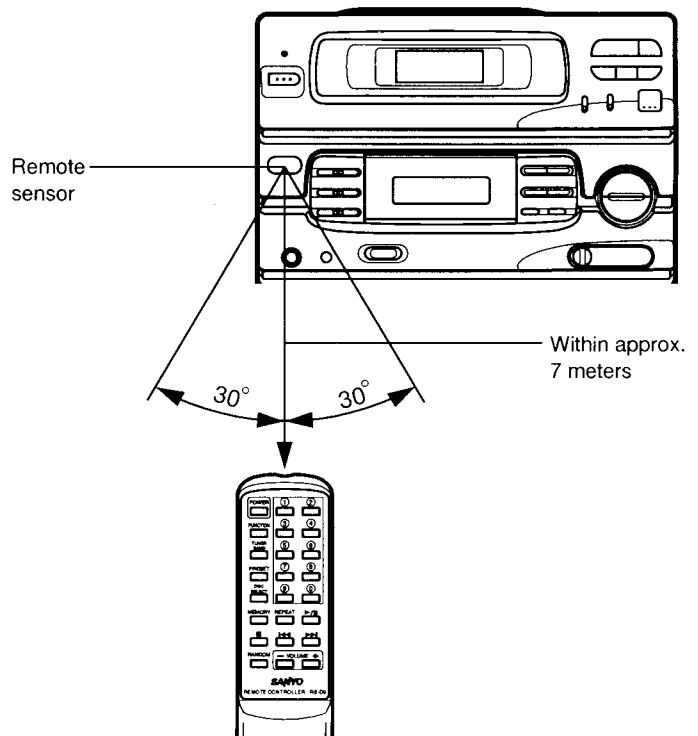

Operation

By using the remote control, you can operate the system in the same way as with the controls on the main unit.

BEFORE OPERATION

Turning the power on and off

Press the POWER button. The displays light and the STANDBY indicator goes out. (After connecting the mains lead, when you press the POWER button for the first time, the volume reset feature automatically sets the initial volume level "Vo 3".)

To turn off the power, press the POWER button again. The STANDBY indicator lights.

- When the mains lead is connected to the AC outlet, the STANDBY indicator lights and the unit will respond to commands from the remote control.

Selecting the function

Press the FUNCTION button to select the desired function. Each time the button is pressed, the display changes as follows:

Cd (CD) → TA (Tape) → TU (Tuner) → Vd (Video) →
Cd (CD) → ...

The function is automatically selected when CD play is started or when the BAND button has been pressed (except during recording or tape dubbing).

- When the function selection is changed, CD play is automatically stopped.

Adjusting the volume

Press the "∧" or "∨" portion of the VOLUME button, or press the "+" or "-" VOLUME button on the remote control. The volume level appears on the display (Vo 0 ~ Vo 10).

Adjusting the left/right speaker balance

Use the BALANCE control to adjust the left/right speaker balance.

Adjusting the sound quality

Use the TREBLE or MID control to adjust the treble or mid range output level.

Bass expander system

Use the BASSXPANDER control to adjust the bass output level.

WHAT TO DO IF ...

If the operation of the unit or display is not normal or when all the memory contents are to be cleared, disconnect the mains lead from the AC outlet, then press the RESET button (rear of the unit) for 20 seconds or more.

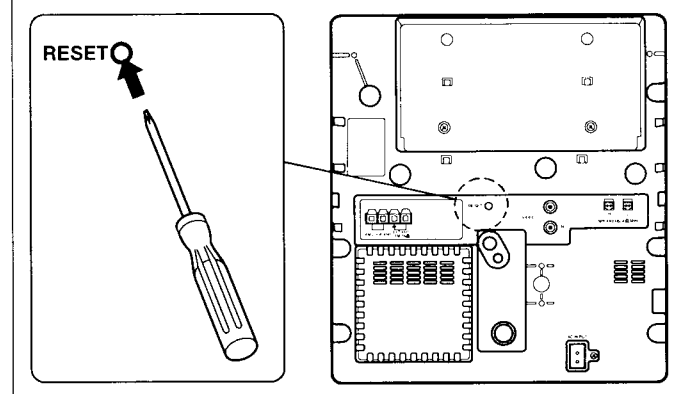

CD PLAY

Use compact discs bearing the symbol shown below. In addition to conventional 12 cm CDs, this system can be used to play 8 cm CDs without an adapter.



Note:

- Do not touch the disc tray while it is moving.
- Never place anything except a compact disc on the disc tray. Foreign objects can damage the unit.
- Do not apply excessive force to the disc tray.
- Discs must be placed on the disc tray one at a time.

1. Select "CD" function by pressing the FUNCTION button. "Cd" appears on the display, then "Cd" is replaced by "dISC". "1" disc number blinks.
2. Press one of the DISC buttons (1, 2 or 3), then press the OPEN/CLOSE button.
 - If the DISC button which "no disc" has been detected by the changer mechanism is pressed, that disc tray slides out automatically.

The selected disc number blinks and the selected disc tray slides out. "OPEN" appears on the display.

3. Place the disc with the label facing up on the disc tray.

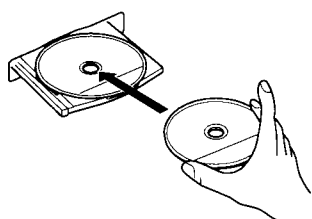

For 12 cm CD

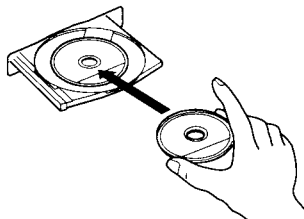

For 8 cm CD

4. Press the OPEN/CLOSE button again to close the disc tray.

5. Repeat steps 2 - 4 to load another disc.
6. Press one of the DISC buttons (1, 2 or 3).



"▷" appears, and play starts from the first track of the selected disc. The track number and elapsed play time for the current track are displayed.

- If the desired disc number has been selected, the PLAY/PAUSE button can also be used to start play.

Note:

If the disc is loaded with the label facing downward, or if a badly scratched disc is loaded, "NO DISC" appears on the display. If this occurs, load the disc correctly or replace the damage disc.

7. Press the STOP button to end disc play. When the last track of the last disc has been played, the player stops automatically.
 - When the OPEN/CLOSE button is pressed during play, play will stop and the disc tray will slide out.

Ejecting discs

1. While in the CD play or stop mode, press one of the DISC buttons to be ejected, then press the OPEN/CLOSE button.
 - While the player is playing one disc, you can eject another disc without stopping play.
2. Remove the disc.

Notes on handling compact discs

- Do not expose the disc to direct sunlight, high humidity or high temperatures for extended periods of time.
- Discs should be returned to their cases after use.
- Do not apply paper or write anything on the disc surface.
- Handle the disc by its edge. Do not touch the playing surface (glossy side).
- Fingerprints and dust should be carefully wiped off the playing surface of the disc with a soft cloth.
Wipe in a straight motion from the centre to the outside of the disc.
- Never use chemicals such as record cleaning sprays, antistatic sprays or fluids, benzene or thinner to clean compact discs.

Temporarily stopping play

Press the PLAY/PAUSE button. "▷" blinks on the display. To resume play, press the button again.

Skip play

To skip to track 6 while track 3 is playing, press the ►►/►►| button repeatedly until "6" appears in TRACK on the display.

To skip back to track 3 while track 6 is playing, press the |◄◄/◄◄ button repeatedly until "3" appears.

- The number buttons on the remote control can also be used for skip play. To skip to track 6 while one track is playing, press 0, then 6.

Search (forward/reverse)

If the ►►/►►| or |◄◄/◄◄ button is pressed during play, the player will search at high speed in the forward or reverse direction while the button is being pressed. When the button is released, normal play will continue.

Random play

Press the RANDOM button on the remote control to begin random play. The player will automatically select and play discs and tracks at random. "RANDOM" appears on the display.

- If the RANDOM button is pressed during random play, the player will select the next random track.
- Random play will not function during programmed play.

Repeat play

Press the REPEAT button repeatedly to select the desired repeat mode in the following sequence. The selected repeat mode is shown on the display.

REPEAT: Repeat all tracks on the selected disc.

REPEAT CONT: Repeat all tracks on all discs.

Released: Normal play mode

Note:

During programmed play, only "REPEAT" can be selected.

Changing discs during play

While the player is playing one disc, press one of the DISC buttons to skip to another disc. "CH DISC" blinks for a few seconds, then the selected disc moves into playing position.

Play starts automatically from the first track on the disc.

PROGRAMMED PLAY

Up to 24 selections, from up to 3 discs, can be programmed for play in any order.

- To begin the programming procedure, select "CD" function first.
- The discs or tracks must be programmed in the stop mode.
- The same disc or track can be programmed more than once.
- Load discs that you want to programme before starting programmed play.

Follow the example below to programme tracks 2 and 6 on DISC 1 and all tracks on DISC 3. In this example, each disc has 9 tracks and DISC 3 is in playing position.

1. Press the MEMORY button.

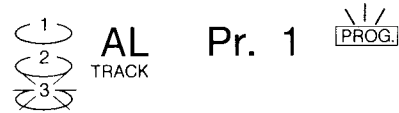

2. Select disc 1 by pressing the DISC 1 button.

- The DISC SELECT button on the remote control can also be used.

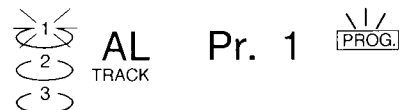

3. Select track 2 by pressing the ►►/►►| button.

- The number buttons on the remote control can also be used.

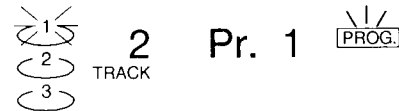

4. Press the MEMORY button. "PROG." remains lit.

5. Select track 6 by pressing the ►►/►►| button.

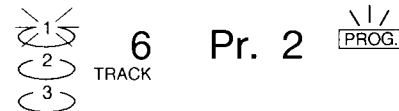

6. Press the MEMORY button. "PROG." remains lit.

7. Select disc 3 by pressing the DISC 3 button.

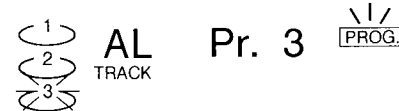

8. Press the MEMORY button. "PROG." remains lit.

9. Press the PLAY/PAUSE button to start play.

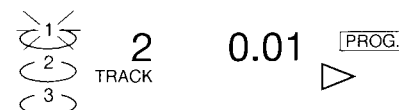

When all programmed selections have played, the player stops automatically. "0 0.00" appears on the display.

- The programme contents are retained in memory.

- Any attempt to programme more than 24 selections will result in "FULL" being displayed and discontinuation of the programming.
- The programme is cleared in the following cases:
 - When the STOP button is pressed in the stop mode
 - When the OPEN/CLOSE button is pressed

Checking the programme

Each time the MEMORY button is pressed in the stop mode, the programmed details sequentially appear on the display.

Changing a programme

To add a new selection to a programme:

1. In the stop mode, press the MEMORY button repeatedly until "- - - -" is displayed.
2. Select a disc and track number as explained above.
3. Press the MEMORY button.

To change a selection:

1. In the stop mode, press the MEMORY button repeatedly until the selection to be replaced is displayed.
2. Select a disc and track number as explained above.
3. Press the MEMORY button.

Note:

Programmed details cannot be partially deleted or inserted.

WHAT TO DO IF ...

If "E-dISC" appears.

1. Press the POWER button to turn the power off.
2. Press the POWER button to turn the power on.

If the operation of the unit or display is not normal, even though the appropriate buttons have been pressed.

1. Disconnect the mains lead.
2. Press the RESET button (rear of the unit) for 20 seconds or more.
3. Connect the mains lead.
4. Press the POWER button to turn the power on.
5. Press the desired function button.

Note:

If the unit does not operate correctly, or "E-dISC" appears again, please contact your nearest SANYO Authorized Service Centre.

LISTENING TO TAPES

Deck A is for playback only; deck B is for both playback and recording. Do not turn the unit off while the tape is running. Otherwise, the pinch roller may be damaged.

1. Select "TAPE". "TA" appears on the display.
2. Press the STOP/EJECT button to open the cassette holder.
3. Load the cassette(s).

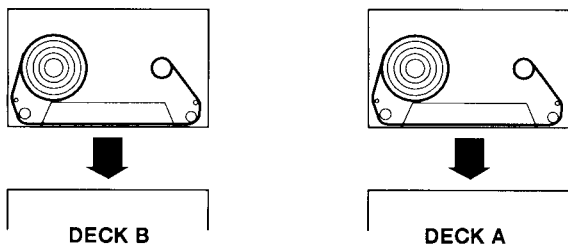

After the cassette has been loaded, push the cassette holder back into position.

4. Press the PLAY button (Deck A or Deck B) to begin playback.
 5. Press the STOP/EJECT button to stop playback at any time. Press it again to remove the cassette.
- When the end of the tape has been reached, automatic stop will be activated.

Note:

- Endless tapes cannot be used.
- Do not use C-120 tapes. They may jam in the mechanism.

Pause (Deck B)

Press the PAUSE button to temporarily stop playback or recording. Press it again to resume operation.

Fast forward and rewind

Press the F FWD or REW button.

When the tape has been wound to the end, the deck stops automatically.

Note:

While playing or recording, do not press the F FWD or REW button of the other deck, or the sound quality may deteriorate.

Sequential playback (From deck A to deck B)

1. Press the PLAY button on deck A. Deck A playback will begin.
2. Press the PAUSE button on deck B.
3. Press the PLAY button on deck B. Deck B enters the pause mode. When the tape automatically stops on deck A, deck B playback will begin. When the end of the tape has been reached on deck B, automatic stop will be activated.

LISTENING TO THE RADIO

Manual tuning

1. Press the BAND button to select FM or AM.
 - "TUNER" is selected automatically. "TU" appears on the display, then "TU" is replaced by the tuner mode display.
2. Press the "+" or "-" TUNING button continuously until you are close to the desired frequency, then press it briefly until the desired frequency is displayed. Each time the button is pressed, the frequency changes in 0.05 MHz steps for FM, 9 kHz steps for AM.

FM 103.25 MHz

To preset stations

Up to 16 stations in each band (FM and AM) can be preset.

1. Tune in the station to be preset as described in "Manual tuning".
2. Press the MEMORY button.

-- FM 103.25 MHz 

3. Press the "+" or "-" PRESET button to select the channel number to be preset.

9 FM 103.25 MHz 

4. Press the MEMORY button.
 - In this example, "103.25 MHz" FM station is preset on FM channel number 9.
 - The number buttons on the remote control can be used for preset the station. In this example, press 0, then 9 after the step 2 above.

9 FM 103.25 MHz

Note:

If the next step is not taken within 10 seconds while performing steps 2 - 4, "PROG." disappears and the preset operation is cancelled. Press the MEMORY button to continue.

5. Repeat the steps above to add more preset stations.

- When presetting a new station, the previously preset station on the same channel number of the same band is cleared.
- The preset stations will be retained in the memory even if the unit is turned off.
If the memory contents are lost due to a power failure or other condition, preset the stations again.

Listening to preset stations

1. Press the BAND button to select FM or AM.
2. Press the "+" or "-" PRESET button to select the desired channel number.
 - The number buttons on the remote control can also be used. Press two number buttons within 4 seconds.

- To receive an FM stereo broadcast, make sure that "MONO" is not displayed. If "MONO" appears, press the MODE button to turn the "MONO" indication off.
"ST" appears when an FM stereo broadcast is received.
- If the signal from an FM stereo station is weak and reception is poor, press the MODE button to change to monaural reception. ("ST" is replaced by "MONO" in the display.)

LISTENING TO VIDEO SOURCES

1. Select "VIDEO". "Vd" appears on the display.
2. Follow the instructions supplied with the video equipment.

BEFORE RECORDING AND DUBBING

Recording copyright material without permission of the copyright owners is usually an infringement. If you wish to re-record copyright material, permission from the copyright owner is necessary. SANYO does not approve of, and cannot be held responsible for, any unlawful use of this machine.

Use deck B for recording.

Accidental erasure prevention tabs (for protecting valuable recordings)

Accidental erasure can be prevented by breaking out the tabs on the end of the cassette tape (where the tape is not exposed) using a screwdriver or similar implement.

If a tab is broken out in error and you wish to re-record the tape, simply block the tab hole using adhesive tape and the tape can be used for recording again.

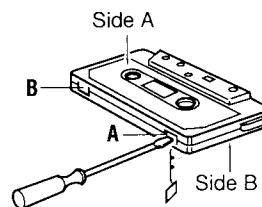

Break out tab A for side A.
Break out tab B for side B.

RECORDING

Recording compact discs (Synchronous recording)

1. Load a blank cassette into deck B.
2. Select "CD".
3. Load the disc(s) to be recorded.
 - For programmed recording, programme the material in advance (as described under "PROGRAMMED PLAY").
4. Press the DISC button (1, 2 or 3) to select the disc to be recorded first, then press the STOP button. Select the track number to be recorded if required.
 - For programmed recording, this step is unnecessary.
5. Press the REC button on deck B. The PLAY button is engaged simultaneously and CD recording starts.
6. Press the STOP/EJECT button on deck B to stop recording. Also the CD player stops automatically.
When the end of the tape is reached, the CD player and deck B stop automatically.

Recording from the tuner or video input

1. Tune in the radio station to be recorded or play a video cassette or video disc.
2. Load a blank cassette into deck B.
3. Press the REC button to start recording.
4. Press the STOP/EJECT button to stop recording.

When beat interference is heard

A high-pitched noise called "beat" is sometimes heard during the recording of radio broadcasts.

In cases like this, set the DUBBING/BEAT CANCEL button to the position that reduces the level of the beat noise.

TAPE DUBBING (Deck A to Deck B)

1. Load the cassette to be played back into deck A and a blank cassette into deck B.
2. Select "TAPE".
3. Set the cassette in deck A to the point where recording will begin.
4. Select the dubbing speed with the DUBBING/BEAT CANCEL button.
NOR:
For dubbing while monitoring at normal speed.
HIGH:
For dubbing tape at high speed (twice normal speed).
5. Press the PAUSE button on deck B.

6. Press the REC button on deck B.
7. Press the PLAY button on deck A to start dubbing.
8. To stop dubbing, press both STOP/EJECT buttons.

Automatic stop during dubbing

- If deck B stops automatically, deck A continues playback mode at normal speed.
- If deck A stops automatically, deck B erases the tape to the end.
- Do not change the dubbing speed during the dubbing operation.

MAINTENANCE

Cleaning the decks A and B heads

To ensure playback and recording with good-quality sound, use cotton swab to clean the heads, pinch rollers and capstans of the decks after about every 10 hours of use.

If the dirt persists, soak the swab in a little methylated spirit or head cleaning fluid and then clean.

Main unit

Use a soft cloth to remove dirt on the main unit.

If the dirt persists, dip a soft cloth into a diluted solution of neutral detergent, wring it out, wipe away the dirt, and then take up any moisture with a dry cloth.

Do not use benzene, thinners or alcohol since they will mar the finish of the surfaces.

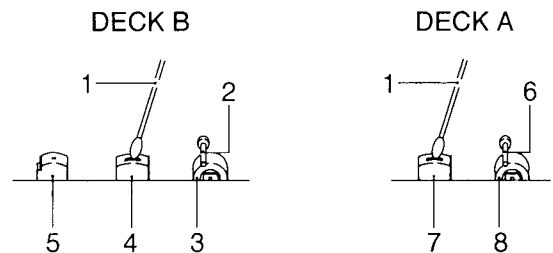

1. Cotton swab
- 2, 6. Capstan
- 3, 8. Pinch roller
- 4, 5, 7. Head

SPECIFICATIONS

Tuner section

Reception frequency:
FM: 87.5 - 108 MHz
AM: 522 - 1611 kHz

CD player section

Type: Changer, 3-disc
Channels: 2-channel stereo
Sampling frequency: 44.1 kHz
Pick-up: Optical 3-beam semiconductor laser
Laser output: 0.6 mW (Continuous wave max.)
Wave length: 790 nm
Frequency response: 20 Hz to 20 kHz
Wow/flutter: Below measurable limits

Cassette deck section

Track system: 4-track, 2-channel stereo
Frequency response: 80 Hz to 13.5 kHz
Signal-to-noise ratio: 50 dB
Wow/flutter: 0.15% (WRMS)
Fast forward/rewind time: Approx. 110 sec. (C-60)

Amplifier section

Output power: 12.5 W x 2 (at 4 ohms, 10% distortion)
Inputs: VIDEO: 400 mV/50k ohms
Outputs: SPEAKERS: 4 ohms
PHONES: 8 - 32 ohms
Power requirements: AC 230 - 240 V, 50 Hz
Power consumption: 45 W
Dimensions: 270(W) x 300(H) x 290(D) mm
Weight: 5 kg

Speaker systems

Type: 2 way bass reflex
Unit used: Woofer: 12 cm cone type
Tweeter: piezoelectric
Maximum power-handling capacity: 25 W (peak)
Nominal impedance: 4 ohms
Dimensions: 180(W) x 300(H) x 194(D) mm
Weight: 1.6 kg (per speaker)

Specifications subject to change without notice.

