

SANYO

INSTRUCTION MANUAL

DC-DA150

Micro Component System

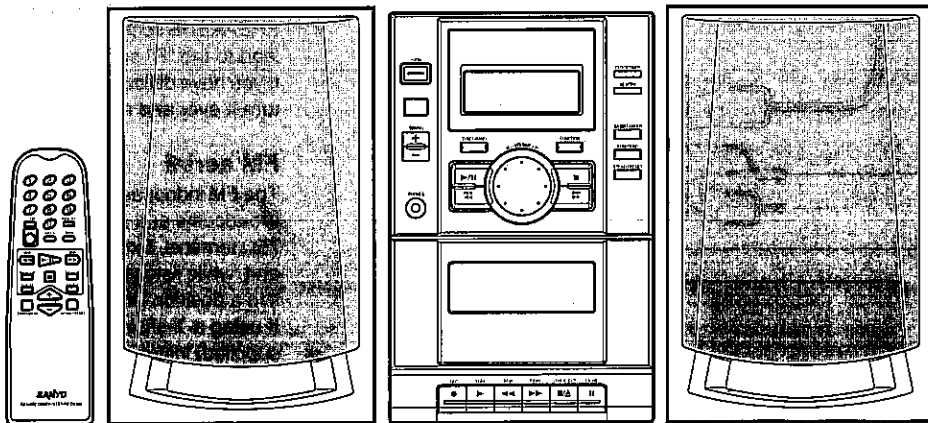

PRECAUTIONS



CAUTION - INVISIBLE LASER RADIATION WHEN OPEN AND INTERLOCKS DEFEATED. AVOID EXPOSURE TO BEAM.
 ADVARSEL - USYNLIG LASER STRÅLING VED ÅBNING, NÅR SIKKERHEDSAFBRYDERE ER UDE AF FUNKTION, UNDGÅ UDSÆTTELSE FOR STRÅLING.
 VARNING - OSYNLIG LASER STRÅLNING NÅR DENNA DEL ÄR ÖPPNAD OCH SPÄRR ÄR URKOPPLAD. STRÅLEN ÄR FARLIG.
 VORSICHT - UNSICHTBARE LASERSTRAHLUNG TRITTS AUS, WENN DECKEL GEÖFFNET UND WENN SICHERHEITSPERRUNG ÜBERBRÜCKT IST. NICHT, DEM STRAHL AUSSETZEN.
 VARO - AVATTAESSA JA SUOJALUKITUS OHITETTAESSA OLET ALTIINA NÄKYMÄTTÖMÄLLE LASERSÄTEILYLLE. ÄLÄ KATSO SÄTEESEEN.

CLASS 1 LASER PRODUCT
 LUOKAN 1 LASERLÄITE
 KLAS 1 LASERAPPARAT

CAUTION - USE OF CONTROLS OR ADJUSTMENTS OR PERFORMANCE OF PROCEDURES OTHER THAN THOSE SPECIFIED IN THE OPERATING INSTRUCTIONS MAY RESULT IN HAZARDOUS RADIATION EXPOSURE. THE COMPACT DISC PLAYER SHOULD NOT BE ADJUSTED OR REPAIRED BY ANYONE EXCEPT PROPERLY QUALIFIED PERSONNEL.

- The apparatus shall not be exposed to dripping or splashing.
- Do not use where there are extremes of temperature (below 5°C or exceeding 35°C) or where direct sunlight may strike it.
- Because of the CD player's extremely low noise and wide dynamic range, there might be a tendency to set the volume on the amplifier unnecessarily high. Doing so may produce an excessively large output from the amplifier which could damage your speakers.
- Sudden changes in the ambient temperature may cause condensation to form on the optical lens inside the unit. If this happens, take out the disc, leave the unit for about 1 hour, and then proceed to operate.
- The system's speakers use powerful magnets. Do not place timepieces, credit cards, cassette tapes or video tapes, etc. near the speakers.
- Do not install this equipment in a confined space, such as a book case or built in cabinet.

CONNECTIONS

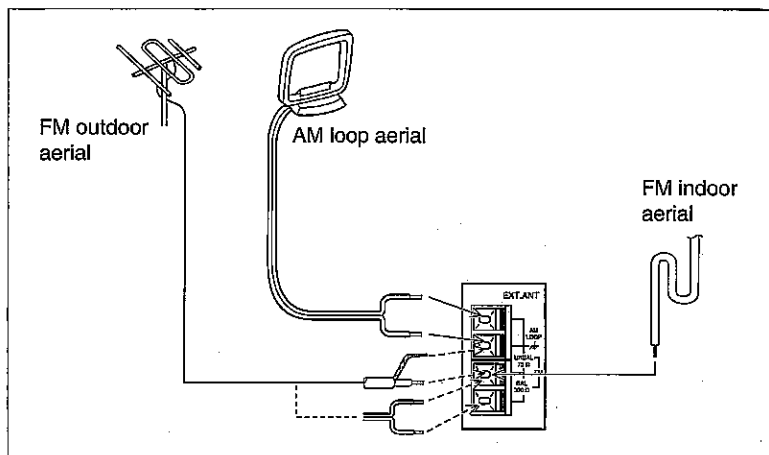

Note:

- Do not connect the mains lead to an AC outlet until all connections have been made.
- The system is not completely disconnected from the mains when the ON/OFF button is set to the OFF position.

Speakers

Connect the connector of the left speaker lead to the "L" SPEAKERS socket and the connector of the right speaker lead to the "R" socket.

If you have difficulty inserting the speaker lead connector, turn it over and reinsert it.

FM aerial

The FM indoor aerial is sufficient to receive most local FM broadcasts and should be connected to the FM UNBAL 75Ω terminal. Extend the aerial wire as straight as possible and, while listening to the sound from the system, secure it in a position which yields minimal distortion and noise. If using a T-shaped FM aerial (300-ohm twin leads, not supplied) instead of the FM indoor aerial, connect it to the FM BAL 300Ω terminals.

If using an FM outdoor aerial (75-ohm coaxial cable, not supplied), connect it to the FM UNBAL 75Ω terminals. Consult your dealer.

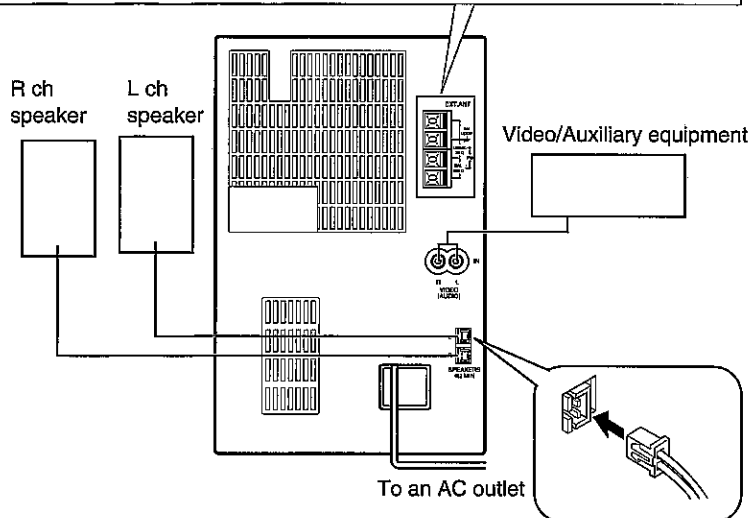

AM loop aerial

Assemble the loop aerial as shown in figure. Unwind the aerial wires, then connect them to the AM LOOP terminals. Place the loop aerial in a position which yields the best AM reception, or attach it to a wall or other surface as shown in figure.

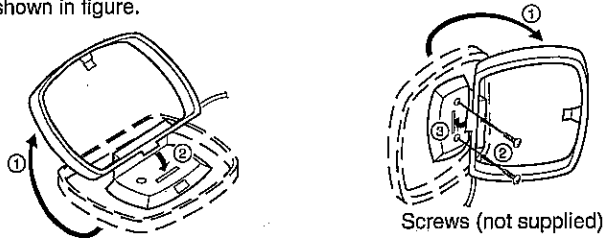

Note:

To minimize noise, the speaker, mains and any other leads should not come close to the FM indoor or outdoor aerial lead and AM loop aerial. Do not place the aerial leads close to the system.

Video/Auxiliary equipment

Connect audio leads (not supplied) from the audio output sockets of a video/auxiliary equipment to the VIDEO sockets.

Headphones

Connect stereo headphones (not supplied) to the PHONES socket for monitoring or for private listening. The speakers are automatically disconnected when headphones are connected.

CONTROLS

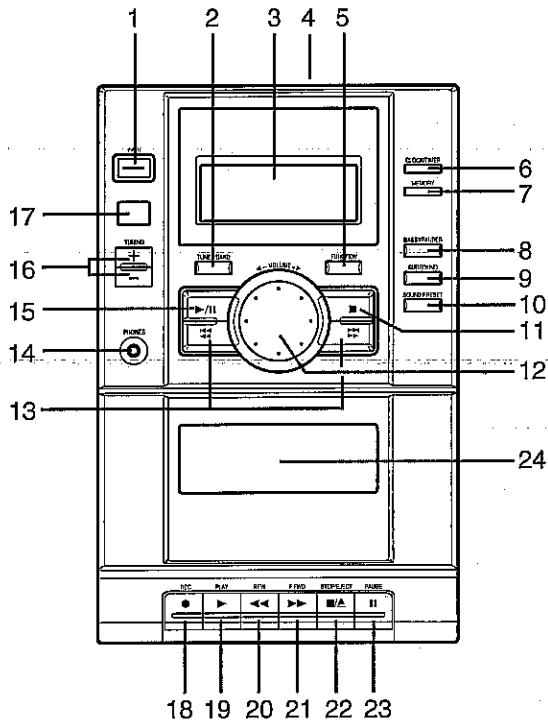

CD player/Tuner/General

1. Power button (⏻/ON)
2. Tuner function/Band select button (TUNER/BAND)
3. Display
4. CD compartment
5. Function button (FUNCTION)
6. Clock/Timer button (CLOCK/TIMER)
7. Memory button (MEMORY)
8. Bass expander button (BASSXPANDER)
9. Surround button (SURROUND)
10. Sound preset button (SOUND PRESET)
11. Stop button (■)
12. Volume/Time setting control (VOLUME)
13. Skip/Search/Preset-tuning-buttons (|◀◀◀, ▶▶▶|)
14. Headphones socket (PHONES)
15. Play/Pause button (▶/||)
16. Tuning buttons (TUNING)
17. Remote sensor (IR)

Cassette deck

18. Record button (REC)
19. Play button (PLAY)
20. Rewind button (REW)
21. Fast forward button (F FWD)
22. Stop/Eject button (STOP/EJECT)
23. Pause button (PAUSE)
24. Cassette holder

REMOTE CONTROL

Controls

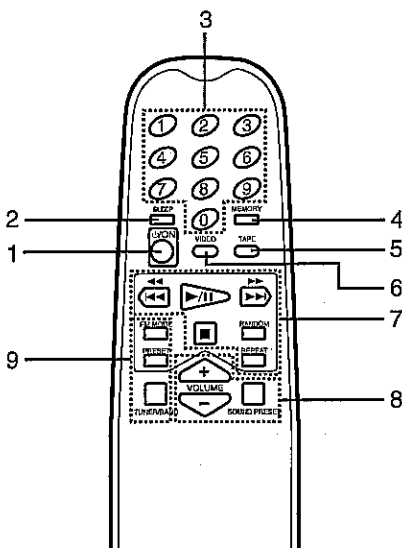

1. Power button (⏻/ON)
2. Sleep timer button (SLEEP)
3. Number buttons (1 - 9, 0)
4. Memory button (MEMORY)
5. Tape function button (TAPE)
6. Video function button (VIDEO)
7. CD player controls
 - ◀◀◀, ▶▶▶: Skip/Search buttons
(These buttons can also be used as TUNER tuning buttons.)
 - ▶/||: Play/Pause button
 - : Stop button
 - RANDOM: Random play button
 - REPEAT: Repeat button
8. General controls
 - VOLUME: Volume buttons
 - SOUND PRESET: Sound preset button
9. Tuner controls
 - FM MODE: FM mode button
 - PRESET: Preset tuning button
 - TUNER/BAND: Tuner function/Band select button

Number buttons (1 - 9, 0)

These buttons are used to select the track numbers on a disc or preset radio stations.

If the function is "CD", the buttons select the track numbers on a disc.

If the function is "TUNER", the buttons select preset radio stations.

With any other function, the buttons will not function.

- Two buttons must always be pressed.

Example:

To select No. 3, press 0, then 3.

To select No. 10, press 1, then 0.

To select No. 25, press 2, then 5.

Inserting batteries

1

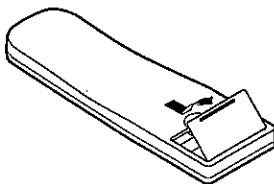

2

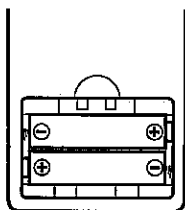

Two R03/AAA batteries
(not supplied)

Note:

Always remove batteries if the remote control is not to be used for a month or more. Batteries left in the unit may leak and cause damage.

Remote control range

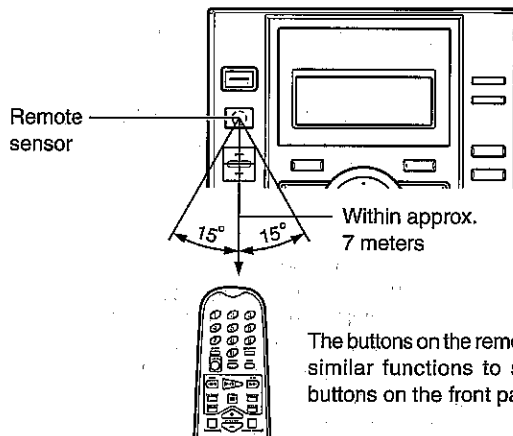

The buttons on the remote control perform similar functions to similarly marked buttons on the front panel.

ADJUSTING THE CLOCK (Main unit only)

Example: To set "PM 6:30",

First, press the \odot /ON button to turn the power off. Only the clock display appears.

1. Press the CLOCK/TIMER button for at least 2 seconds. "0" blinks on the display.

2. Press the MEMORY button. The hours display blinks.

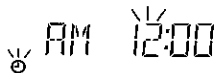

3. Turn the VOLUME control to set the "hours."

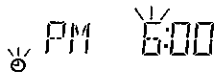

4. Press the MEMORY button. The minutes display blinks.

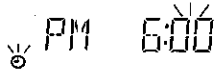

5. Turn the VOLUME control to set the "minutes."

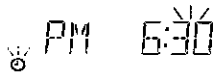

6. Press the MEMORY button. The clock starts.

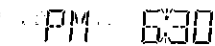

- The time can be set accurately by pressing the MEMORY button when a time signal is heard.

- To display the clock during operation, press the CLOCK/TIMER button briefly. After a few seconds, the original display returns.

- If a power failure occurs or the mains lead is disconnected, the clock display blinks. Reset the time again.

Changing the clock to the 24-hour display

1. Press the \odot /ON button to turn the power on.

2. Press the FUNCTION button to select "TAPE".

3. Press the CLOCK/TIMER button to display the clock.

4. While clock is displaying, press the MEMORY button and hold it, then press the \blacktriangleright /II button.

Example: PM 1:00 \rightarrow 13:00

To return the original setting, repeat steps above.

BEFORE OPERATION

Turning the power on and off

Press the \odot /ON button. The display lights and "WELCOME" appears briefly.

To turn the power off, press the \odot /ON button again. "GOOD BYE" appears briefly and the clock display remains lit.

- When the mains lead is connected to the AC outlet, the unit will respond to commands from the remote control.

Direct start function

If the following buttons are pressed when the unit is in standby, the unit turns on automatically and the selected function is set.

CD section	\blacktriangleright /II
Tuner section	TUNER/BAND
Remote control	\blacktriangleright /II, TUNER/BAND, VIDEO

Selecting the function

Press the FUNCTION button to select the desired function. Each time the button is pressed, the display changes as follows:

CD \rightarrow TAPE \rightarrow TUNER \rightarrow VIDEO:AUX \rightarrow CD \rightarrow ...

The function is automatically selected when CD play is started or when the TUNER/BAND button has been pressed (except during recording).

- When the function selection is changed, CD play is automatically stopped.

Adjusting the volume

Turn the VOLUME control, or press the + or - VOLUME button on the remote control. The volume level appears by numbers (VOL 0 - VOL MAX) and bar-graph on the display.

Surround sound system

Press the SURROUND button. "SURROUND" appears on the display and a "Wide" effect is created.

Bass expander system

Press the BASSXPANDER button to enhance the bass sound. "BASS" appears on the display.

Selecting the sound mode

Press the SOUND PRESET button to select the sound mode matching the music to be listened to.

POP: Pops, etc.

ROCK: Rock music, etc.

JAZZ: Jazz, etc.

CLASSIC: Classical music, etc.

WHAT TO DO IF ...

If the operation of the unit or display is not normal,

1. Disconnect the mains lead.
2. Wait for at least 30 seconds.
3. Connect the mains lead.
4. Operate the unit.

CD PLAY

Use compact discs bearing the symbol shown. In addition to conventional 12 cm CDs, this system can be used to play 8 cm CDs without an adapter.



If disc is loaded, you can turn the unit on and begin play immediately by pressing the ►/|| button.

1. Press the FUNCTION button to select "CD" function. "CD" appears on the display, then "CD" is replaced by the CD mode display.
2. Press the CD compartment lid (CD OPEN/CLOSE portion) to open it. "OPEN" appears.

3. Place the disc with the label facing up on the disc turntable. (Place only one disc at a time.)
4. Press the CD compartment lid (CD OPEN/CLOSE portion) to close it. The total number of tracks and total playing time on the disc appear.

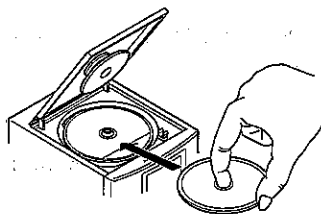

Also, the whole track numbers (up to track 16) on the disc are displayed on the music calendar.

Note:

If the disc is loaded with the label facing downward, or if a badly scratched disc is loaded, "NO DISC" appears. If this occurs, load the disc correctly or replace the damaged disc.

5. Press the ►/|| button. Play starts from the first track. The current track number and elapsed playing time are displayed.



6. Press the ■ button to end disc play. When the last track has been played, the player stops automatically.

Note:

Always press the ■ button and wait for the disc to stop rotating before opening the CD compartment.

Notes on handling compact discs

- Do not expose the disc to direct sunlight, high humidity or high temperatures for extended periods of time.
- Discs should be returned to their cases after use.
- Do not apply paper or write anything on the disc surface.
- Handle the disc by its edge. Do not touch the playing surface (glossy side).
- Fingerprints and dust should be carefully wiped off the playing surface of the disc with a soft cloth. Wipe in a straight motion from the centre to the outside of the disc.
- Never use chemicals such as record cleaning sprays, antistatic sprays or fluids, benzene or thinner to clean compact discs.

To start play from the desired track

Select the track by using the ►►►► or ◀◀◀◀ button, then press the ►/|| button.

Using the remote control

Press two number buttons within 4 seconds. (Example: press 0, then 3.)

Temporarily stopping play

Press the ►/|| button. "▷" blinks on the display. To resume play, press the button again.

Skip play

To skip to track 6 while track 3 is playing, press the ►►►► button repeatedly until "6" appears (in the track section) on the display. To skip back to track 3 while track 6 is playing, press the ◀◀◀◀ button repeatedly until "3" appears.

- The number buttons on the remote control can also be used for skip play. To skip to track 6 while one track is playing, press 0, then 6.

Search (forward/reverse)

If the ►►►► or ◀◀◀◀ button is pressed during play, the player will search at high speed in the forward or reverse direction while the button is being pressed. When the button is released, normal play will continue.

Random play (Remote control only)

Press the RANDOM button to begin random play. The player will automatically select and play tracks on the disc at random. "RANDOM" appears on the display.

- Random play will not function during programmed play.

Repeat play (Remote control only)

Press the REPEAT button before or during play. The player will play all the tracks or all the programmed tracks repeatedly. "REPEAT" appears on the display. To cancel repeat play, press the REPEAT button again. "REPEAT" disappears.

PROGRAMMED PLAY

Up to 24 tracks on a disc can be programmed for play in any order.

- First, select "CD" function and load a disc that you want to programme.
- The tracks must be programmed in the stop mode.
- The same track can be programmed more than once.

1. Press the MEMORY button.

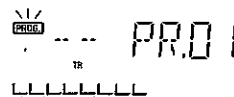

2. Select a track by using the ►►►► or ◀◀◀◀ button.

- The number buttons on the remote control can also be used.



3. Press the MEMORY button.



4. Repeat steps 2 - 3 to programme additional tracks.

5. Press the ►/|| button to start programmed play.

When all programmed tracks have played, the player stops automatically. "0 0.00" appears on the display.



- The programme contents are retained in memory.

- Any attempt to programme more than 24 tracks will result in "FULL" being displayed and discontinuation of the programming.

- To cancel programmed play, press the ■ button twice.

Checking the programme

Each time the MEMORY button is pressed in the stop mode, the programmed details sequentially appear on the display.

Changing a programme

To add a new track to a programme:

1. In the stop mode, press the MEMORY button repeatedly until "- - -" is displayed.
2. Select a track as explained above.
3. Press the MEMORY button.

To change a track:

1. In the stop mode, press the MEMORY button repeatedly until the track number to be replaced is displayed.
2. Select a track as explained above.
3. Press the MEMORY button.

Note:

Programmed details cannot be partially deleted or inserted.

LISTENING TO TAPES

1. Press the FUNCTION button to select "TAPE".
2. Press the STOP/EJECT button to open the cassette holder.
3. Load the cassette.

After loading the cassette, push the cassette holder back into position.

4. Press the PLAY button to begin playback.
5. Press the STOP/EJECT button to stop playback at any time. Press it again to remove the cassette.

When the end of the tape has been reached, automatic stop will be activated.

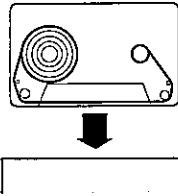

Note:

- Use the normal tape (TYPE 1).
- Endless tapes cannot be used.
- Do not use C-100 (or longer) tapes. They may jam in the mechanism.

Pause

Press the PAUSE button to temporarily stop playback or recording. Press it again to resume operation.

Fast forward and rewind

Press the F FWD or REW button. When the desired location has been reached, press the STOP/EJECT button.

LISTENING TO THE RADIO

Before use

When the unit is shipped from the factory, its AM frequency band is set as "522 - 1710 kHz (in 9 kHz steps)".

If your local AM broadcast system is organized in 10 kHz steps, change the frequency band to "520 - 1710 kHz (in 10 kHz steps)" as follows.

1. Press the TUNER/BAND button to select "AM".
2. While pressing the MEMORY button on the front panel, press the TUNER/BAND button on the front panel.

To return the original setting, repeat steps above.

To turn the unit on and listen to the last received station, press the TUNER/BAND button.

Automatic/Manual tuning

1. Press the TUNER/BAND button to select FM or AM.
 - "TUNER" is selected automatically. "TUNER" appears on the display, then "TUNER" is replaced by the tuner mode display.

2. Automatic tuning

Press the + or - TUNING button for at least 1 second to tune in a station. The unit will scan up or down the band and receive the next receivable station. Press the button again to continue.

- The ►►►► or ◀◀◀◀ button on the remote control can also be used.

Manual tuning

Press the + or - TUNING button briefly until the desired frequency is displayed.

FM 103.25 MHz

To preset stations

Up to 24 stations for FM band, and up to 12 stations for AM band can be preset.

Automatic presetting (APT) (Main unit only)

1. Press the TUNER/BAND button to select FM or AM.
2. Press the MEMORY button for at least 3 seconds. "PROG." blinks. The automatic tuning mode is set and automatic presetting begins from the low end of the band. When 24 stations for FM, 12 stations for AM have been preset or the high end of the band is reached, automatic presetting stops. "PROG." disappears and the previous received station is heard.
3. To preset stations on the other band, follow steps above.

Note:

If APT is activated, all previously programmed stations of the band will be cleared and new stations will be programmed.

Manual presetting

1. Tune in the station to be preset as described in "Automatic/Manual tuning".

2. Press the MEMORY button.

FM PROG MHz

3. Press the ►►►► or ◀◀◀◀ button on the front panel (or PRESET button on the remote control) to select the channel number to be preset.

FM PR09 MHz

4. Press the MEMORY button.

- In this example, "103.25 MHz" FM station is preset on FM channel 9.
- The number buttons on the remote control can be used to preset the station directly. In this example, press 0, then 9 after the step 2 above.

FM 103.25 MHz

Note:

If the next step is not taken within 2 seconds while performing steps 2 - 4, "PROG." disappears and the preset operation is cancelled. Press the MEMORY button to continue.

5. Repeat steps above to add more preset stations.

- When presetting a new station, the previous preset station is cleared.

Listening to preset stations

1. Press the TUNER/BAND button to select FM or AM.
2. Press the ►►►► or ◀◀◀◀ button on the front panel (or PRESET button on the remote control) to select the desired channel number. The selected channel number appears briefly.
 - The number buttons on the remote control can also be used. Press two number buttons within 2 seconds.

To receive FM stereo broadcasts (Remote control only)

Make sure that "MONO" is not displayed. If "MONO" appears, press the FM MODE button to turn the "MONO" indication off.

"ST" appears when an FM stereo broadcast is received.

- If the signal from an FM stereo station is weak and reception is poor, press the FM MODE button to change to the MONO mode. The reception may be improved, but the sound will be monaural.

LISTENING TO OTHER SOURCES

1. Press the FUNCTION button to select "VIDEO:AUX".

2. Follow the instructions supplied with the Video/Auxiliary equipment.

RECORDING

Recording copyright material without permission of the copyright owners is usually an infringement. If you wish to re-record copyright material, permission from the copyright owner is necessary. SANYO does not approve of, and cannot be held responsible for, any unlawful use of this machine.

Recording compact discs (Synchronous recording)

1. Load a blank cassette.
2. Select "CD" function.
3. Load the disc to be recorded.
 - For programmed recording, programme the material in advance (as described under "PROGRAMMED PLAY").
4. Select the track number to be recorded if required.
 - For programmed recording, this step is unnecessary.
5. Press the REC button. The PLAY button is engaged simultaneously and CD recording starts.
6. Press the STOP/EJECT button to stop recording. Also the CD player stops automatically.

When the end of the tape is reached, the CD player and deck stop automatically.

Recording from the tuner or other sources

1. Load a blank cassette.
2. Tune in the radio station to be recorded or play other source.
3. Press the REC button to start recording.
4. Press the STOP/EJECT button to stop recording.

When beat interference is heard

A high-pitched noise called "beat" is sometimes heard during the recording of radio broadcasts. If this occurs,

1. Press the MEMORY button.
2. While "PROG." is blinking, press the + TUNING button to select "BC-1" or "BC-2". Select the setting that gives the best results.

Safeguards against accidental erasure

Accidental erasure can be prevented by breaking out the tabs on the end of the cassette tape (where the tape is not exposed) using a screwdriver or similar implement.

If a tab is broken out in error and you wish to re-record the tape, simply block the tab hole using adhesive tape and the tape can be used for recording again.

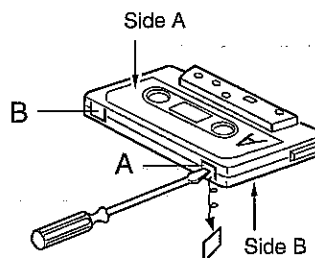

Break out tab A for side A.
Break out tab B for side B.

TIMER OPERATION

Using the timer (Main unit only)

Set the on and off times, and function to be used. Operation will start with the selected function at the on time. The sound will be gradually increased from a no-sound level to the current volume setting (fade-in). The power will be switched off at the off time.

The timer will function every day unless it is released.

Preparation

Note:

Make absolutely sure that the clock is set to the correct time before setting the timer.

- Prepare the sources to be used.
- If the function selected is tuner, tune in to the desired band and station.
- Adjust the volume level as desired.

Operation

1. Press the CLOCK/TIMER button for at least 2 seconds.

AM 4:25

The previous timer on time setting appears.

2. Press the MEMORY button within 10 seconds.

AM 4:25

3. Set the timer on time by turning the VOLUME control, then press the MEMORY button (as described under "ADJUSTING THE CLOCK").

AM 7:25 → AM 7:30

The timer off time setting appears.

4. Set the timer off time as described in step 3.

AM 8:15 → TUNER

The previous function setting appears.

5. Press the FUNCTION button to select the function for timer operation.
6. Press the MEMORY button.

The original display returns, then the timer operation standby mode is activated. "⌚" remains lit.
7. Press the ⏻/ON button to switch off the power.

- To switch off the power during a timer controlled operation, press the ⏻/ON button. The timer will be set in the standby mode.

To release the timer

After turning the power on, press the CLOCK/TIMER button twice. "⌚" disappears.

To set the timer again with the same settings

1. Press the CLOCK/TIMER button repeatedly to display "⌚".
2. Press the ⏻/ON button to switch off the power.

Note:

The timer operation is released if a power failure occurs.

Using the sleep timer (Remote control only)

The sleep timer automatically switches off the power after a preset time has elapsed. The volume will gradually be reduced (fade-out) during the 1-minute period before the unit turns off. There are 12 time periods available: 120, 110, 100, 90, 80, 70, 60, 50, 40, 30, 20 and 10 minutes.

Press the SLEEP button repeatedly to select the desired sleep time. "SLEEP" blinks and the selected time appears on the display. After a few seconds, the original display returns. "SLEEP" remains blinking.

To check the remaining sleep time

Press the SLEEP button once. After a few seconds, the original display returns.

To release the sleep timer while in operation

Press the SLEEP button repeatedly until "SLEEP" disappears. The timer is also released if the power is switched off.

MAINTENANCE

Cleaning the tape heads

To ensure continued high performance, use cotton swab to clean the heads, pinch roller and capstan of the deck after about every 10 hours of use. If the dirt persists, soak the swab in a little methylated spirit or head cleaning fluid and then clean.

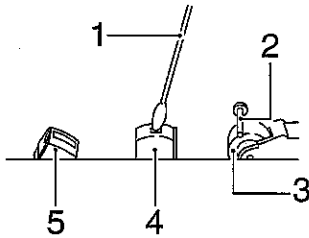

1. Cotton swab
2. Capstan
3. Pinch roller
- 4, 5. Head

Cleaning the CD player lens

The lens should never be touched. If dust is on the lens, blow it off using a camera lens blower. (Consult your dealer.)

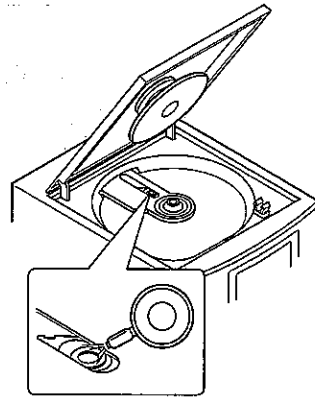

Cleaning the unit

Clean the outside of the unit with a clean soft cloth, moistened with lukewarm water. Do not use benzene, thinner or alcohol since they will mar the finish of the surfaces.

SPECIFICATIONS

Tuner

Reception frequency:

FM: 87.5 - 108 MHz

AM: 522 - 1710 kHz (9 kHz step)

520 - 1710 kHz (10 kHz step)

CD player

Channels:

2-channel stereo

Sampling frequency:

44.1 kHz

Pick-up:

Optical 3-beam semiconductor laser

Laser output:

0.6 mW (Continuous wave max.)

Wave length:

790 nm

Wow/flutter:

Below measurable limits

Cassette deck

Track system:

4-track, 2-channel stereo

Frequency response:

80 Hz to 13.5 kHz

Signal-to-noise ratio:

45 dB

Wow/flutter:

0.15% (WRMS)

Fast forward/rewind time:

Approx. 110 sec. (C-60)

General

Output power:

6 W x 2 (at 4 ohm, 10% distortion)

Input

VIDEO IN: 400 mV/50k ohm

Outputs

SPEAKERS: 4 ohm

PHONES: 8 - 32 ohm

Power requirements:

AC 230 - 240 V, 50 Hz

Power consumption:

30 W

Dimensions:

160(W) x 250(H) x 213(D) mm

Weight:

2.8 kg

Speaker systems

Type:

2-way bass reflex

Unit used:

12 cm cone type woofer

5 cm cone tweeter

Maximum power-handling capacity:

12 W (peak)

Nominal impedance:

4 ohm

Dimensions:

160(W) x 250(H) x 203(D) mm

Weight:

1.8 kg (per speaker)

Specifications subject to change without notice.

SANYO