

# SANYO

---

## INSTRUCTION MANUAL

## DC-S300

### Mini Component System

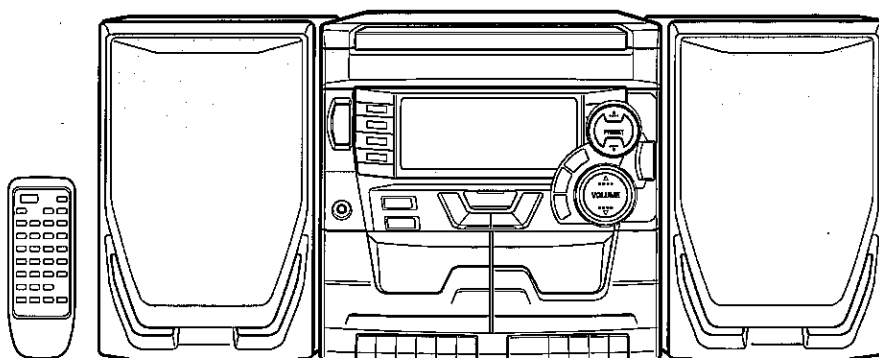

# PRECAUTIONS

CAUTION - INVISIBLE LASER RADIATION WHEN OPEN AND INTERLOCKS DEFEATED. AVOID EXPOSURE TO BEAM.

ADVARSEL - USYNLIG LASER STRÅLING VED ÅBNING, NÅR SIKKERHEDSAFBRYDERE ER UDE AF FUNKTION, UNDGÅ UDSÆTTELSE FOR STRÅLING.

VARNING - OSYNLIG LASER STRÅLNING NÅR DENNA DEL ÅR ÖPPNAD OCH SPÄRR ÅR URKOPPLAD. STRÅLEN ÅR FARLIG.

VORSICHT - UNSICHTBARE LASERSTRAHLUNG TRITT AUS, WENN DECKEL GEÖFFNET UND WENN SICHERHEITSVERRIEGELUNG ÜBERBRÜCKT IST. NICHT, DEM STRAHL AUSSETZEN.

VARO - AVATTAESSA JA SUOJALUKITUS OHITETTAESSA OLET ALTTIINA NÄKYMÄTTÖMÄLLE LASERSÄTEILYLLE. ÄLÄ KATSO SÄTEESEEN.



CLASS 1 LASER PRODUCT  
LUOKAN 1 LASERLAITE  
KLASS 1 LASERAPPARAT

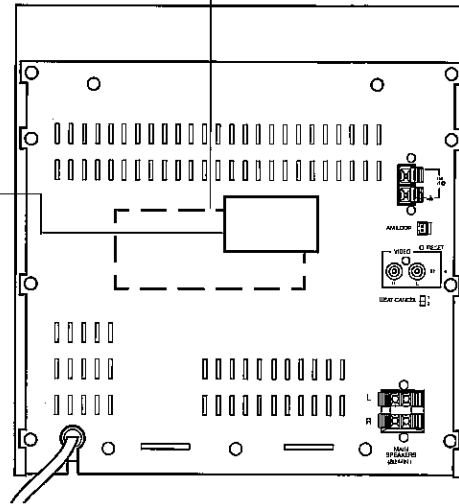

**CAUTION** - USE OF CONTROLS OR ADJUSTMENTS OR PERFORMANCE OF PROCEDURES OTHER THAN THOSE SPECIFIED IN THE OPERATING INSTRUCTIONS MAY RESULT IN HAZARDOUS RADIATION EXPOSURE.

THE COMPACT DISC PLAYER SHOULD NOT BE ADJUSTED OR REPAIRED BY ANYONE EXCEPT PROPERLY QUALIFIED PERSONNEL.

- The apparatus shall not be exposed to dripping or splashing.
- Do not use where there are extremes of temperature (below 5°C or exceeding 35°C) or where direct sunlight may strike it.
- Because of the CD player's extremely low noise and wide dynamic range, there might be a tendency to set the volume on the amplifier unnecessarily high. Doing so may produce an excessively large output from the amplifier which could damage your speakers.
- **When carrying the unit, be sure to remove any discs which may be inside and press the  $\text{O}$ /ON button on the front panel to turn the power off. Then unplug the mains lead from the AC outlet. Carrying the unit with any discs inside may damage the discs and/or the unit.**
- Sudden changes in the ambient temperature may cause condensation to form on the optical lens inside the unit. If this happens, take out the disc, leave the unit for about 1 hour, and then proceed to operate.
- The system's speakers use powerful magnets. Do not place timepieces, credit cards, cassette tapes or video tapes, etc. near the speakers.
- Do not install this equipment in a confined space, such as a book case or built in cabinet.

# CONNECTIONS

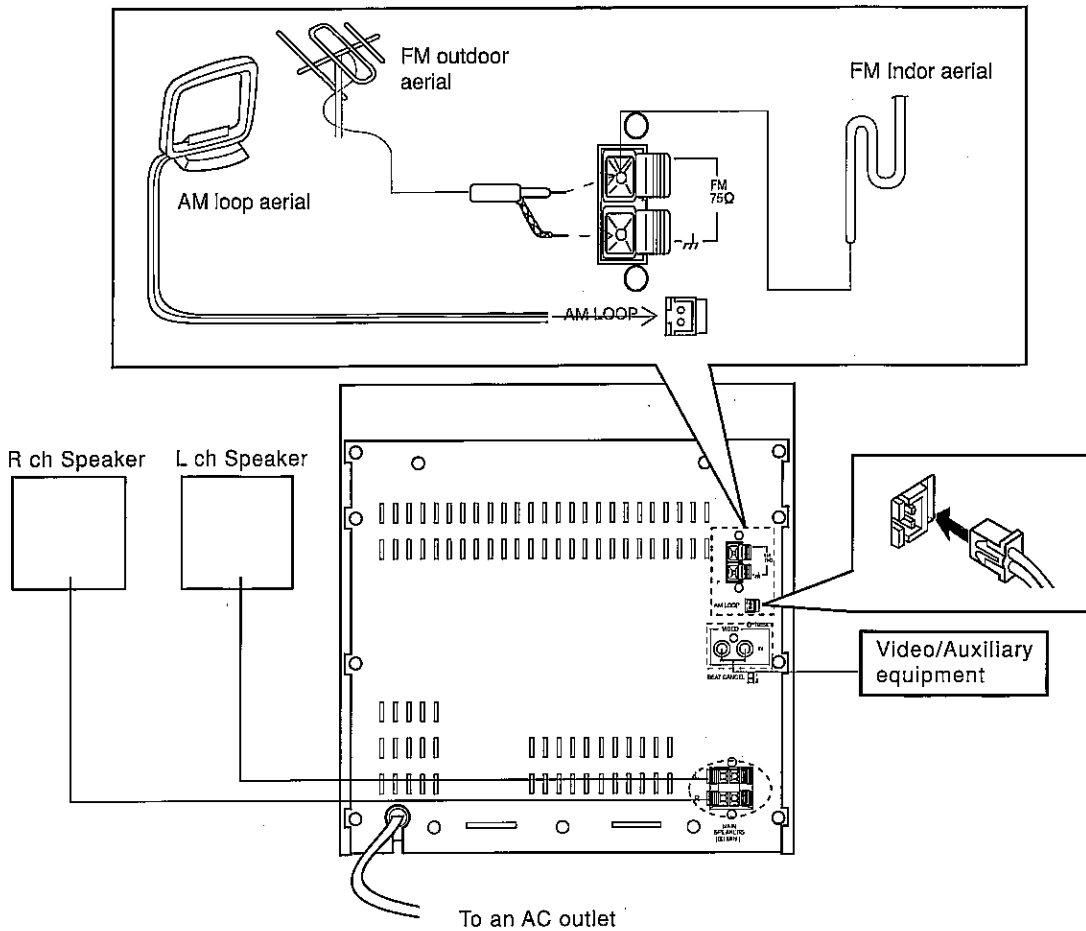

**Note:**

- Do not connect the mains lead to an AC outlet until all connections have been made.
- The system is not completely disconnected from the mains when the  $\phi$ /ON button is set to the  $\phi$  position.

**Speakers**

To achieve proper stereo reproduction, identical connections must be made at the speakers and this unit.

Connect the red speaker wire to the red MAIN SPEAKER terminal (+) and the black wire to the black terminal (-).

**FM aerial**

The FM indoor aerials is sufficient to receive most local FM broadcasts and should be connected to the FM 75Ω terminal. Extend the aerial wire as straight as possible and, while listening to the sound from the system, secure it in a position which yields minimal distortion and noise.

In fringe areas or where reception is distorted or noisy an external aerial (not supplied) should be connected instead of the simple indoor aerial.

Consult your dealer.

**AM loop aerial**

Assemble the loop aerial as shown in figure.

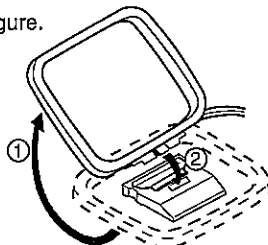

Unwind the aerial wires, then connect them to the AM LOOP terminals. Place the loop aerial in a position which yields the best AM reception, or attach it to a wall or other surface as shown in figure.

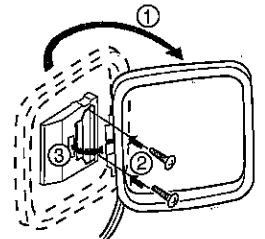

Screws (not supplied)

If you have difficulty inserting the AM loop aerial cable connector, turn it over and reinsert it.

**Note:**

To minimize noise, the speaker, mains and any other leads should not come close to the FM indoor or outdoor aerial lead and AM loop aerial. Do not place the aerial leads close to the system.

**Video/Auxiliary equipment**

Connect audio leads (not supplied) from the audio output sockets of a video/auxiliary equipment to the VIDEO sockets.

**Headphones**

Connect stereo headphones (not supplied) to the PHONES socket for monitoring or for private listening. The speakers are automatically disconnected when headphones are connected.

# CONTROLS

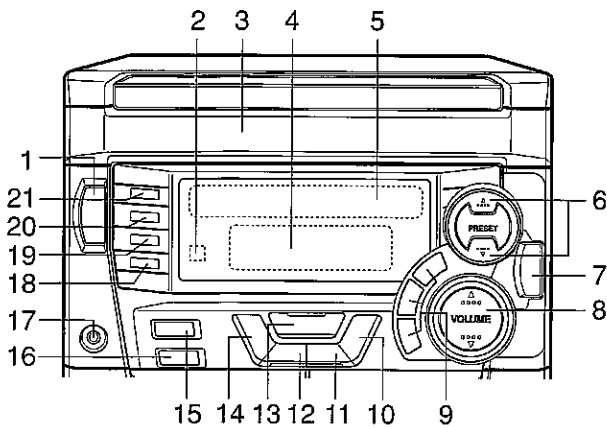

## CD player/Amplifier/Tuner section

1. Power button (⏻/ON)
2. Remote sensor (IR)
3. Disc trays (inside the door)
4. Display
5. Sound preset indicators (ROCK, CLASSIC, POPS, JAZZ)
6. Preset tuning button (▼ PRESET ▲)
7. Open/Close button for disc tray (CD OPEN/CLOSE)
8. Volume button (▼ VOLUME ▲)
9. DISC select buttons (DISC 1, DISC 2, DISC 3)
10. Tuning up, Skip/Search button (TUNING +, ►►/►►)
11. Play/Pause button (►/||)
12. Stop button (■)
13. Disc change button (DISC CHANGE)
14. Tuning down, Skip/Search button (TUNING -, ◀◀/◀◀)
15. Bass expander button (BASSXPANDER)
16. Sound preset button (SOUND PRESET)
17. Headphone jack (PHONES)
18. Memory button (MEMORY)
19. FM mode select button (FM MODE)
20. Band select button (BAND)
21. Function select button (FUNCTION)

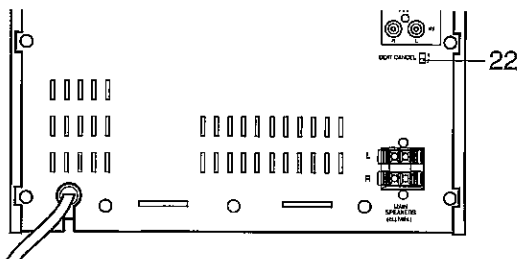

(back of the unit)

22. Beat cancel switch (BEAT CANCEL)

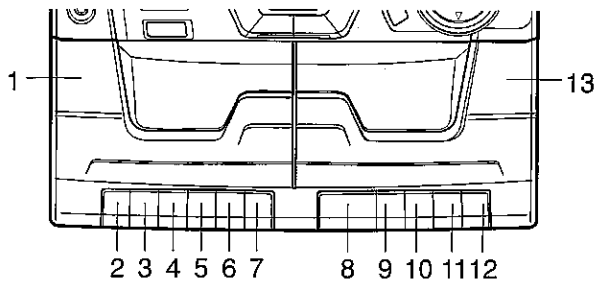

## Cassette deck section

### Deck B

1. Cassette holder (DECK B)
2. Record button (REC)
3. Play button (PLAY)
4. Rewind button (REW)
5. Fast forward button (FFWD)
6. Stop/Eject button (STOP/EJECT)
7. Pause button (PAUSE)

### Deck A

8. Play button (PLAY)
9. Rewind button (REW)
10. Fast forward button (FFWD)
11. Stop/Eject button (STOP/EJECT)
12. Pause button (PAUSE)
13. Cassette holder (DECK A)

# REMOTE CONTROL

## Controls

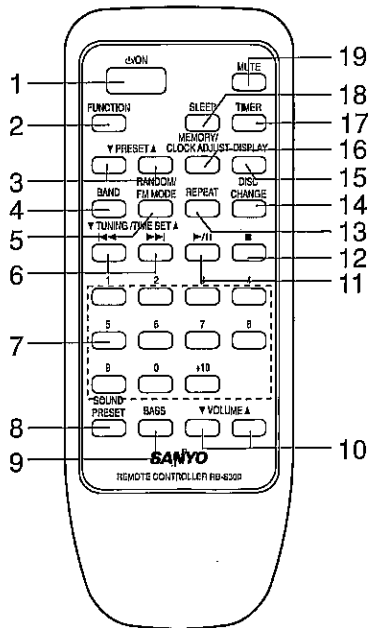

1. Power button (⏻/ON)
2. Function select button (FUNCTION)
3. Preset tuning buttons (▼ PRESET ▲)
4. Band select button (BAND)
5. Random/FM mode button (RANDOM/FM MODE)
6. Skip/Search, Tuning/Time set buttons (▼ TUNING/TIME SET ▲, ◀, ▶)
7. Number buttons (1-9, 0, +10)
8. Sound preset button (SOUND PRESET)
9. Bass expander button (BASS)
10. Volume buttons (▼ VOLUME ▲)
11. Play/Pause button (▶/⏸)
12. Stop button (■)
13. Repeat button (REPEAT)
14. Disc change button (DISC CHANGE)
15. Display button (DISPLAY)
16. Memory/Clock adjust button (MEMORY/CLOCK ADJUST)
17. Timer button (TIMER)
18. Sleep button (SLEEP)
19. Muting button (MUTE)

### Number buttons ( 1-9, 0, +10 )

These buttons are used to select the track numbers on a disc or preset radio stations.

If the function is "CD", the buttons select the track numbers on a disc. If the function is "TUNER", the buttons select preset radio stations. With any other function, the buttons will not function.

Example:

- To select No. 3, press 3.
- To select No. 10, press +10, then 0.
- To select No. 25, press +10 twice, then 5.

## Inserting batteries

1

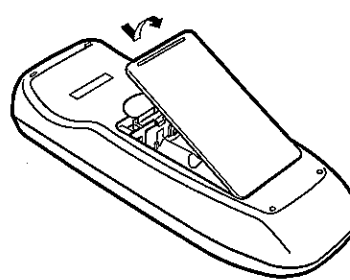

2

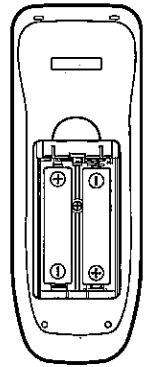

Two "R6/AA" batteries (not supplied)

### Note:

Always remove batteries if the remote control is not to be used for a month or more. Batteries left in the unit may leak and cause damage.

## Remote control range

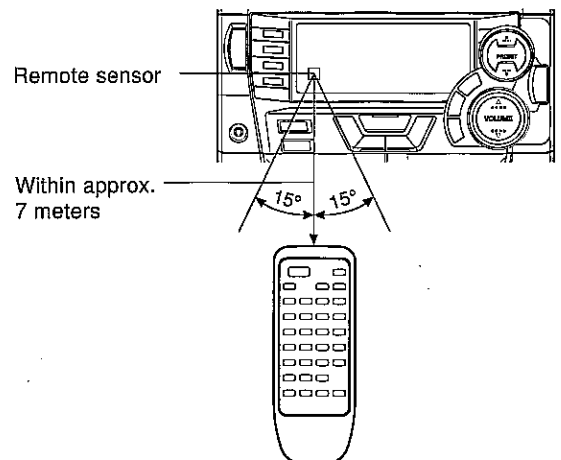

The buttons on the remote control perform similar functions to similarly marked buttons on the front panel.

# ADJUSTING THE CLOCK (Remote control only)

## NOTE:

When the unit is first connected to the AC power line, it enters the demonstration mode.

To cancel this mode, press the  $\phi$ /ON button.

### Example: To Set "PM 6:30"

1. Press the  $\phi$ /ON button to turn the power on.
2. Press the DISPLAY button.  
"AM 12:00" blinks on the display.

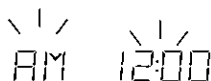

3. Press the CLOCK ADJUST button. The hours display blinks.

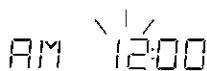

4. Press the TIME SET button  $\nabla$  or  $\blacktriangle$  to set "hours".

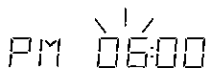

5. Press the CLOCK ADJUST button, the minutes display blinks.

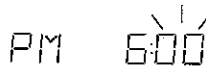

6. Press the TIME SET button  $\nabla$  or  $\blacktriangle$  to set the minutes.

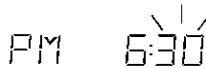

7. Press the CLOCK ADJUST button, the clock starts.



- The time can be set accurately by pressing the CLOCK ADJUST button. When a time signal is heard.
- To display the clock during operation, press the DISPLAY button briefly. After a few seconds, the original display returns.
- If a power failure occurs or the mains leads is disconnected, the clock display blinks. Reset the time again.

## BEFORE OPERATION

### Turning the power on and off

Press the  $\phi$ /ON button. The displays light.

To turn off the power, press the  $\phi$ /ON button again.

- When the mains lead is connected to the AC outlet, the unit will respond to commands from the remote control.

### Selecting the function

Press the FUNCTION button to select the desired function. Each time the FUNCTION button is pressed, the display changes as follows:

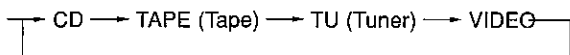

The function is automatically selected when the CD play is started, or while the BAND button is pressed.

- When the function selection is changed, CD play is automatically stopped.

### Adjusting the volume

Press the VOLUME button  $\Delta$  or  $\nabla$ . The volume level appears on the display (VOL 0 ~ VOL 40).

### Bass expander system

Press the BASSXPANDER button to enhance the bass sound. "BASS" appears on the display.

### Selecting the sound mode

Press the SOUND PRESET button to select the sound mode matching the music to be listened to.

- ROCK: Rock music, etc.
- CLASSIC: Classical music, etc.
- POPS: Pops, etc.
- JAZZ: Jazz, etc.

### WHAT TO DO IF . . .

If the operation of the unit or display is not normal.

1. Disconnect the mains lead.
2. Press the RESET button (rear of the unit) for at least 20 seconds.
3. Connect the mains lead.
4. Resume the operation.

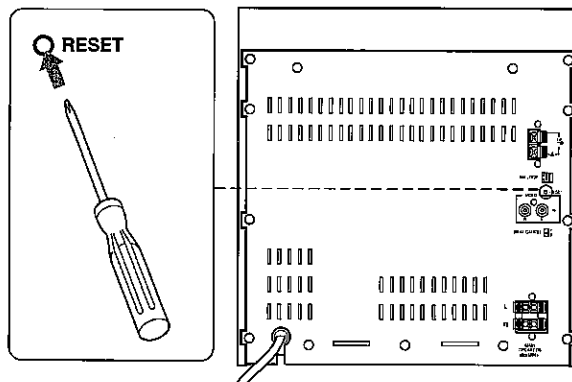

# CD PLAY

Use compact discs bearing the symbol shown. In addition to conventional 12 cm CDs, this system can be used to play 8 cm CDs without an adapter.



**Note:**

- Do not touch the disc tray while it is moving.
- Never place anything except a compact disc on the disc tray. Foreign objects can damage the unit.
- Do not apply excessive force to the disc tray.
- Discs must be placed on the disc tray one at a time.
- Place the unit in a stable location, and use it in a horizontal position.

1. Press the **ON** button to turn the power on.
2. Press the **FUNCTION** button to select the "CD" function. "CD" blinks on the display, then "no disc" appears.
3. Press the **CD OPEN/CLOSE** button, the disc tray slides out.

4. Place each disc in the tray with the label facing up.
5. Press the **DISC CHANGE** to turn the carousel to the next tray position.

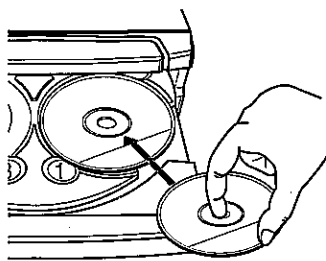

6. Press the **CD OPEN/CLOSE** button again to close the disc tray.

**Selected disc play**

7. Press one of the disc select buttons (**DISC 1**, **DISC 2**, **DISC 3**) to select the disc to be played. "►" and "1 DISC" appears. Play starts from the first track of the selected disc. The track number and elapsed playing time for the current track are displayed. After play stops at the end of the last track of the selected disc, the total number and total playing time of the selected disc and "TOTAL" appear.

**Note:**

If the disc is loaded with label facing downward, or if a badly scratched disc is loaded, the player will search a playable disc. If a playable disc is not found, "no disc" blinks on the display.

8. Press the **■** button at any time to end disc play.

**Notes on handling compact discs**

- Do not expose the disc to direct sunlight, high humidity or high temperatures for extended periods of time.
- Discs should be returned to their cases after use.
- Do not apply paper or write anything on the disc surface.
- Handle the disc by its edge. Do not touch the playing surface (glossy side).
- Fingerprints and dust should be carefully wiped off the playing surface of the disc with a soft cloth. Wipe in a straight motion from the centre to the outside of the disc.
- Never use chemicals such as record cleaning sprays, antistatic sprays or fluids, benzene or thinner to clean compact discs.

**To start play from the desired track**

1. Press the desired disc select button (**DISC 1**, **DISC 2**, **DISC 3**), then press the **■** button.
2. Select the desired track by using the **◀◀/◀** or **▶/▶▶** button, then press the **▶/||** button.

**Ejecting or changing discs**

While the changer is playing one disc, you can eject another disc without stopping play.

1. Press the **CD OPEN/CLOSE** button when a disc is playing, play will not stop and the disc tray will slide out.
2. Remove (or replace) the disc.
3. Press the **CD OPEN/CLOSE** button.

**Temporarily stopping play**

Press the **▶/||** button. "►" and elapsed playing time blink on the display. To resume play, press the button again.

**Skip play**

To skip to track 6 while track 3 is playing, press the **▶▶/▶▶▶** button repeatedly until "6" appears in the **TRACK** section on the display. To skip back to track 3 while track 6 is playing, press the **◀◀/◀◀◀** button repeatedly until "3" appears.

**Search (forward/reverse)**

If the **◀◀/◀◀◀** or **▶▶/▶▶▶** button is pressed during play, the player will search at high speed in the forward or reverse direction while the button is being pressed. When the button is released, normal play will continue.

**Repeat play (Remote control only)**

This unit has three different repeat modes. Press the **REPEAT** button on the remote control repeatedly to select the desired mode in the following sequence. The selected repeat mode is shown on the display.

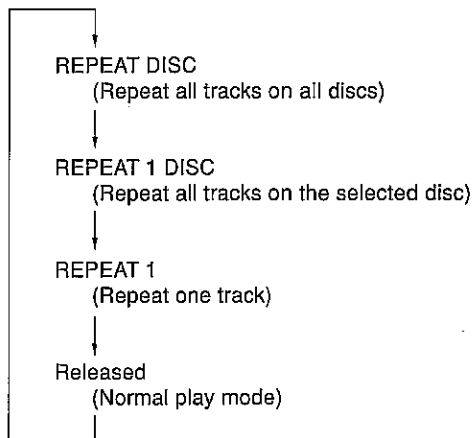

**Note:**

During programmed play, only "REPEAT" and "REPEAT 1" can appear.

**Random play (Remote control only)**

1. Press the **RANDOM** button repeatedly on the remote control, display changes as following.

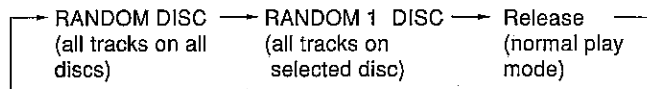

2. Press the **▶/||** button to start random play. The player will automatically select and play discs and tracks at random.

**Changing discs during play**

While the player is playing one disc, press one of the disc select buttons (**DISC 1**, **DISC 2**, **DISC 3**) to skip to another disc.



"- - -" blinks for a few seconds, then the selected disc moves into playing position.



Play starts automatically from the first track on the disc.

**Time display selection**

Press the **DISPLAY** button repeatedly during normal play. The display changes in the following sequence:

- REMAIN (Remaining playing time for the current track)
- REMAIN TOTAL (Total remaining playing time for the disc)
- TOTAL (Elapsed playing time for the disc)

**Notes:**

- During programmed play, "REMAIN TOTAL" and "TOTAL" cannot be displayed.
- The displayed playing times may differ slightly from the times listed on the notes accompanying the disc.

## PROGRAMMED PLAY

Up to 60 selections, from up to 3 discs, can be programmed for play in any order.

- To begin the programming procedure, select the "CD" function first.
- The discs or tracks must be programmed in the stop mode.
- The same disc or track can be programmed more than once.
- Load the disc that you want to programme before starting programmed play.

### Programming procedure

Follow the example below to programme tracks 2 and 6 on DISC 1, track 9 on DISC 2 and all tracks on DISC 3. In this example, each disc has 9 tracks and DISC 3 is in playing position.

1. Press the MEMORY button.



2. Select DISC 1 by pressing the DISC 1 button.

- The DISC CHANGE button on the remote control can also be used.

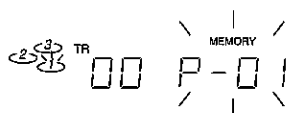

3. Select track 2 by pressing the ►►/►►► button.

- The number buttons on the remote control can also be used.

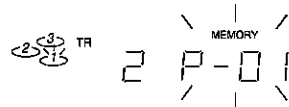

4. Press the MEMORY button.



5. Select track 6 by pressing the ►►/►►► button.

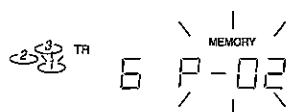

6. Press the MEMORY button.



7. Select DISC 2 by pressing the DISC 2 button.

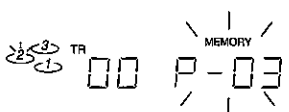

8. Select track 9 by pressing the ►►/►►► button.

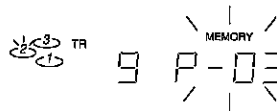

9. Press the MEMORY button.



10. Select DISC 3 by pressing the DISC 3 button.

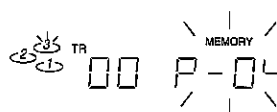

11. Select "AL" (all) by pressing the ►►/►►► button.

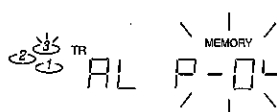

12. Press the MEMORY button.

13. Press the ►/|| button to start play.

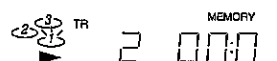

When all programmed selections have been played, the first programmed track on DISC 1 will appear and "MEMORY" will blink.

- The programme contents are retained in memory.
- The maximum number of selections that can be programmed is 60. If you try to enter more selections, "FULL" blinks on the display.
- The programme is cleared when the ■ button is pressed in the stop mode.

### Checking the programme

Each time the MEMORY button is pressed in the stop mode, the programmed details sequentially appear on the display.

### Changing a programme

To add a new selection to a programme:

1. In the stop mode, press the MEMORY button repeatedly until "00" on the track section appears on the display.
2. Select a disc and track number as explained above.
3. Press the MEMORY button.

To change a selection:

1. In the stop mode, press the MEMORY button repeatedly until the selection to be replaced is displayed.
2. Select a disc and track number as explained above.
3. Press the MEMORY button.

Note:

Programmed tracks cannot be deleted individually.



# LISTENING TO TAPES

Deck A is for playback only; Deck B is for both playback and recording.

1. Select "TAPE". "TAPE" appears on the display.
2. Press the STOP/EJECT button to open the cassette holder.
3. Load the cassette(s).

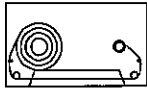

Deck B

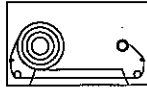

Deck A

After the cassette has been loaded, push the cassette holder back into position.

4. Press the PLAY button (Deck A or Deck B) to begin playback.
5. Press the STOP/EJECT button to stop playback at any time. Press it again to remove the cassette.

When the end of the tape has been reached, automatic stop will be activated.

Note:

- Endless tapes cannot be used.
- Do not use C-120 tapes. They may jam in the mechanism.

## Pause

Press the PAUSE button to temporarily stop playback or recording. Press it again to resume operation.

## Fast forward and rewind

Press the F FWD or REW button.

When the desired location or the end of the tape is reached, press the STOP/EJECT button.

Note:

While playing or recording, do not press the FFWD or REW button of the other deck, or the sound quality may deteriorate.

## Sequential playback (From deck A to deck B)



1. Press the PLAY button on deck A. Deck A playback will begin.
2. Press the PAUSE button on deck B.
3. Press the PLAY button on deck B. Deck B enters the pause mode.  
When the tape automatically stops on deck A, deck B playback will begin.  
When the end of the tape has been reached on deck B, automatic stop will be activated.

# LISTENING TO THE RADIO

## Before use

When the unit is shipped from the factory, its AM frequency band is set as "522 - 1710 kHz (in 9 kHz steps)".

If your local AM broadcast system is organized in 10 kHz steps, change the frequency band to "520 - 1710 kHz (in 10 kHz steps)" as follows.

1. Press the BAND button to select "AM".
2. While pressing the  button on the front panel, press the  button and the BAND button on the front panel at the same time.

To return the original setting, repeat steps above.

## Automatic/Manual tuning

1. Press the BAND button to select AM or FM.
  - "TU" blinks on the display, then "TU" is replaced by the tuner mode display.

### 2. Automatic tuning

Press the TUNING + button or the TUNING - button for at least 1 second to tune in a station. The unit will scan up or down the band and select the next receivable station. Press the button again to continue.

### Manual tuning

Press the TUNING + button or the TUNING - button briefly until the desired frequency is displayed.

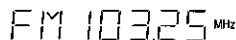



## To preset stations

Up to 20 stations for FM band and up to 10 stations for AM band can be preset.

1. Tune in the station to be preset as described in "Automatic/Manual tuning".
2. Press the MEMORY button.



3. Press the PRESET button  or  to select the channel number to be preset.



4. Press the MEMORY button.
  - In this example, "103.25 MHz" FM station is preset on FM channel 9.
  - The number buttons on the remote control can be used to preset the station directly. In this example, press 9 after the step 2 above.

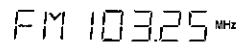





### Note:

If the MEMORY button is not pressed within 3 seconds, the station is preset automatically.

5. Repeat steps above to add more preset stations.
  - When presetting a new station, the previous preset station is cleared.
  - The preset stations will be retained in the memory even if the unit is turned off.
  - If the memory contents are lost due to a power failure or other condition, programme the stations again.

## Listening to preset stations

1. Press the BAND button to select FM or AM.
2. Press the PRESET button  or  (or the PRESET button  or  on the remote control) to select the desired programme number.

- The number buttons on the remote control can also be used.

## To receive FM stereo broadcasts

"ST" appears when an FM stereo broadcast is received. If not, press the FM MODE button to turn the "ST" indication on.

"ST" appears when an FM stereo broadcast is received.

- If the signal from an FM stereo station is weak and reception is poor, press the FM MODE button to change to the MONO mode. The reception may be improved, but the sound will be monaural.

# LISTENING TO OTHER SOURCES

1. Press the FUNCTION button to select "VIDEO". "VIDEO" appears on the display.
2. Follow the instructions supplied with the Video/Auxiliary equipment.

# BEFORE RECORDING AND DUBBING

Recording copyright material without permission of the copyright owners is usually an infringement. If you wish to re-record copyright material, permission from the copyright owner is necessary. SANYO does not approve of, and cannot be held responsible for, any unlawful use of this machine.

Use deck B for recording.

## Accidental erasure prevention tabs (for protecting valuable recordings)

Accidental erasure can be prevented by breaking out the tabs on the end of the cassette tape (where the tape is not exposed) using a screwdriver or similar implement.

If a tab is broken out in error and you wish to re-record the tape, simply block the tab hole using adhesive tape and the tape can be using for recording again.

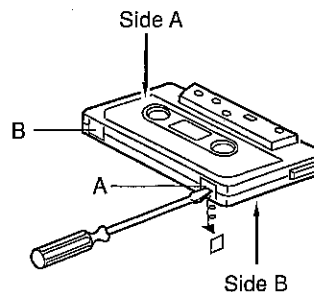

Break out tab A for side A.  
Break out tab B for side B.

# RECORDING

## Recording compact discs (Synchronous recording)

1. Load a blank cassette into deck B.
2. Select "CD".
3. Load the disc(s) to be recorded.
  - For programmed recording, programme the material in advance (as described under "PROGRAMMED PLAY").
4. Press the disc select button (DISC 1, DISC 2 or DISC 3) to select the disc to be recorded first, then press the button. Select the track number to be recorded if required.
  - For programmed recording, this step is unnecessary.
5. Press the REC button on deck B. The PLAY button is engaged simultaneously and CD recording starts.
6. Press the STOP/EJECT button on deck B to stop recording.  
When the end of the tape is reached before CD player stops, deck B stops, CD play pauses.

## Recording from playing track

When you want to record music as you listen, press the REC button. Recording starts automatically from the beginning of the track.

## Recording from the tuner or video input

1. Tune in the radio station to be recorded, or play a video equipment.
2. Load a blank cassette into deck B.
3. Press the REC button to start recording.
4. Press the STOP/EJECT button to stop recording.

## When beat interference is heard

A high-pitched noise called "beat" is sometimes heard during the recording of radio broadcasts. If this occurs, select position 1 or 2. Leave the switch in the position that gives the best results.

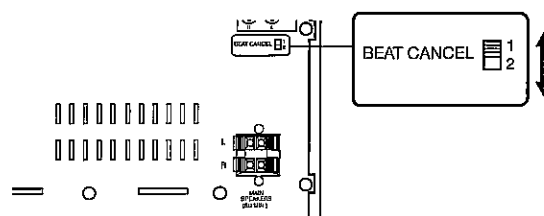

# TAPE DUBBING (Deck A to Deck B)

1. Load the cassette to be played back into deck A and a blank cassette into deck B.
2. Select "TAPE".
3. Set the cassette in deck A to the point where recording will begin.
4. Deck B: Locate the tape position where recording will begin.
5. Press the PAUSE button on deck B.
6. Press the REC button on deck B.
7. Press the PLAY button on deck A to start dubbing.
8. To stop dubbing, press both STOP/EJECT button.

## Automatic stop during tape dubbing

- If deck B stops automatically, deck A continues playback mode.
- If deck A stops automatically, deck B erases the tape to the end.

# TIMER OPERATION (Remote control only)

Before setting the timer, make sure that the clock is set to the present time. See "ADJUSTING THE CLOCK".

## USING THE WAKE UP TIMER

Set the wake-up time, source to be heard and volume level. At the set time, the selected source will be heard. The wake up timer will function every day unless it is released.

### Example:

**Waking up 7:30 AM every day and listening to music until 8:15 AM**

1. Load a compact disc or select "TUNER".
  - If "TUNER" is selected, select the desired station first.
  - Adjust the volume level as desired.
2. Press the DISPLAY button. The preset time appears.
3. Press the DISPLAY button again. "ON" blinks. The previous wake-up time appears.



AM 12:00

4. Press the CLOCK ADJUST button while "ON" is blinking. "ON" and "hour" display blink.



AM 1:00

5. Press the "▼" or "▲" TIME SET button to set the "hour" display.



AM 07:00

6. Press the CLOCK ADJUST button. "ON" and "minute" display blink.



AM 7:00

7. Press the "▼" or "▲" TIME SET button to set the "minute" display.



AM 7:30

8. Press the CLOCK ADJUST button. This completes the setting of the ON time. "ON" remains blink.



AM 7:30

9. Press the DISPLAY button while "ON" is blinking. "OFF" blinks. The previous timer OFF time appears.

10. Press the CLOCK ADJUST button while "OFF" is blinking, the "OFF" and "hour" display blink.



AM 07:30

11. Set the OFF time by following steps 5 to 8 above. This completes the setting of the OFF time.



AM 8:15

12. Press the DISPLAY button. The original display returns.
13. Press the TIMER button three times, "ON OFF" appears on the display.
14. Press the ON/OFF button to turn the power off. The present time display remains. "ON OFF" remains lit.

When the timer ON time arrives, the power is turned on automatically and the unit starts playing with the preset function selected.

- "ON OFF" remains lit while timer operation is engaged.
- When the timer OFF time arrives, the power turns off and the timer is set to the standby mode. Timer operation repeats this cycle every day.

### To check the timer settings

Turn on the power, then press the DISPLAY button repeatedly. The timer settings are displayed in the following order.

- Present time
- ON time
- OFF time
- Original display returns.

### To change the timer settings

1. Press the DISPLAY button to select the setting to be changed.
2. Press the CLOCK ADJUST button on the remote control so that the display blinks.
3. Change the setting as explained above.

### TO CANCEL THE TIMER/TO USE THE TIMER AGAIN WITH THE SAME CONTENTS:

1. Press the TIMER button. "ON OFF" disappears from the display.

The TIMER ON time and TIMER OFF time will not function.

  - To use the previous timer setting, press the TIMER button repeatedly to display "ON OFF"
2. Press the ON/OFF button to turn the power off.

### USING THE SLEEP TIMER

This timer automatically switches off the power after a preset time has elapsed. There are 9 time periods available: 90, 80, 70, 60, 50, 40, 30, 20, and 10 minutes.

Press and hold down the SLEEP button to select the desired sleep time. "SLEEP" blinks and the selected time appears on the display. After several seconds, the original display returns "SLEEP" remains lit.

### To release the sleep timer while in operation

Press the SLEEP button, "SLEEP" disappears from the display. The timer is also released if the power is switched off.

# MAINTENANCE

## Cleaning the tape heads

To ensure continued high performance, use cotton swab to clean the heads, pinch roller and capstan of the deck after about every 10 hours of use. If the dirt persists, soak the swab in a little methylated spirit or head cleaning fluid and then clean.

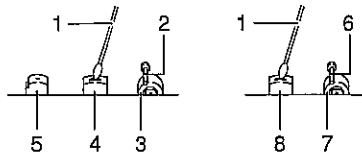

1. Cotton swab
- 2, 6. Capstan
- 3, 7. Pinch roller
- 4, 5, 8. Head

## Cleaning the unit

Clean the outside of the unit with a clean soft cloth, moistened with lukewarm water. Do not use benzene, thinner or alcohol since they will mar the finish of the surfaces.

# SPECIFICATIONS

## Tuner

Reception frequency:

FM: 87.5 - 108 MHz

AM: 522 - 1710 kHz (9 kHz step)  
520 - 1710 kHz (10 kHz step)

## CD player

Channels:

2-channel stereo

Sampling frequency:

44.1 kHz

Pick-up:

Optical 3-beam semiconductor laser

Laser output:

0.6 mW (Continuous wave max.)

Wave length:

790 nm

Wow/flutter:

Below measurable limits

## Cassette deck

Track system:

4-track, 2-channel stereo

Frequency response:

125 Hz to 8 kHz

Signal-to-noise ratio:

45 dB

Wow/flutter:

0.3% (WRMS)

Fast forward/rewind time:

Approx. 120 sec. (C-60)

## General

Output power:

2.5W x 2 (at 8 ohms, 10% distortion)

Input:

VIDEO IN: 400 mV/50k ohms

Outputs:

SPEAKERS: 8 ohms

PHONES: 8 - 32 ohms

Power requirements:

AC 230 - 240 V, 50 Hz

Power consumption:

25 W

Dimensions:

279(W) x 290(H) x 353(D) mm

Weight:

4.9 kg

## speaker system

Type:

Full range bass reflex

Unit used:

12 cm cone type

Maximum power-handling capacity:

5 W (peak)

Nominal impedance:

8 ohms

Dimensions:

190(W) x 290(H) x 189(D) mm

Weight:

1.6 kg (per speaker)

Specifications subject to change without notice.





